

4D-F8

Suitable for ages over 14

Quadcopter operating instructions

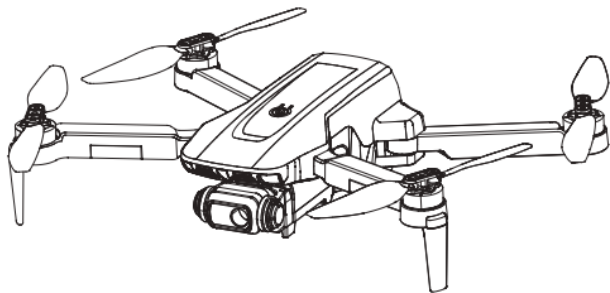

GPS

English

- In order to meet the requirements of the aeronautical radio station's electromagnetic environment (various of aero models and UAV are not allowed to fly within the range of 10 km on each side of center line and 20km on both ends of the airport runway and in the) and civil aviation routes and airlines. Using various models and drones in the no-fly zone issued by the relevant state departments is prohibited.

Warning

1. The packaging and instructions contain important information and should be kept.
2. With this aircraft, you are responsible for ensuring that no harm will be caused to the personal and property of others.
3. Commissioning and installing of aircraft must be strictly in accordance with the operating instructions, and attention shall be paid to the distance between the aircraft and the user or other people shall be 2 to 3m to prevent the aircraft from bumping into the head, face and body of people and causing injury in flying and landing, etc.
4. Our company and distributors are not responsible for any loss and damage, as well as injury to people caused by improper use or operation.
5. Children should be guided by adults when operating the aircraft. This product is prohibited to be operated by children under 14 years old.
6. Please follow the instructions or packaging instructions to install and use correctly, and some parts should be assembled by adults.
7. The product contains small parts, please place it out of the reach of children to prevent the risk of accidental eating or suffocation.
8. It is strictly forbidden to play on the road or in the place where water is accumulated to avoid accidents.
9. Please put away the packing materials in time to avoid harm to children.
10. Do not disassemble or modify the aircraft. Disassembly or modification may cause malfunction to the aircraft.
11. The charging cable needs to be inserted into the designated power supply 5V $\overline{\text{---}}$ 2A that is the same as the product label.
12. The use of other charging cables will cause damage to the battery and may cause unexpected dangers.
13. The charging cable is not a toy.
14. When charging the rechargeable battery, it must be under the supervision of an adult. When charging, it must be far away from flammable materials. During charging, the guardian should not leave the monitoring range.
15. Please do not short circuit or squeeze the battery to avoid explosion.
16. Do not mix different types of lithium batteries.
17. The aircraft uses a rechargeable lithium battery, which needs to be pulled out for charging.
18. Do not short-circuit, decompose or throw the battery into fire; do not put the battery in a place with high temperature and heat (such as in fire or near electric heating device).
19. The aircraft should be used as far away from other electrical equipment and magnetic objects as possible, they may cause mutual interference.
20. Please keep a safe distance from the high-speed rotating propeller to avoid the risk of scalp or cut
21. The motor is a hot part; please do not touch it to avoid burns.
22. LED has laser radiation; please do not give direct light beam to others.
23. Do not use the model near your ears! Misuse may cause hearing damage.
24. The USB charging cable must use the data cable provided by our company to charge the battery, otherwise it will cause serious damage to the battery and will lead to unexpected danger.
25. To meet the magnetic environment requirements of aeronautical radio stations. During the radio control order issued by the relevant state departments, the model remote control should be stopped within the city area as required.
26. Turn off the switch and unplug the battery when the battery of the aircraft is used up, and charge after 30 minutes of rest, otherwise the battery will be easily damaged.

1. List of accessories included:



Aircraft x1



USB charging cable x1



Fan blade x2



Lithium battery x1



Screwdriver x1



Operating Instructions x1

2. Name of each part of aircraft:

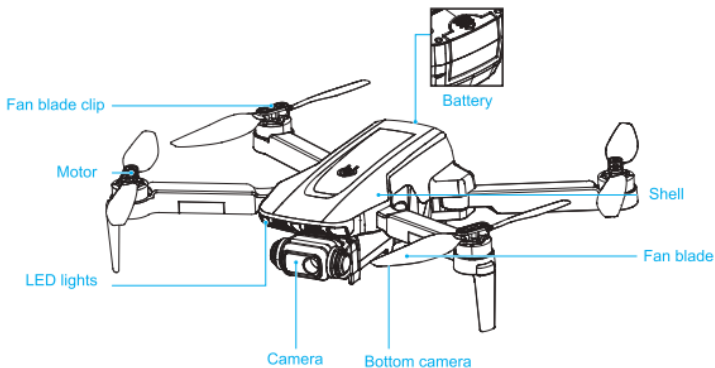

3. Wind blade installation diagram:

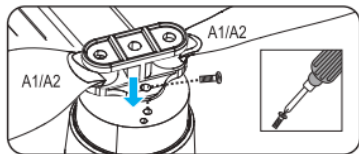

3.1 Unscrew the screw and remove the fan blade.

⚠ Note: The fan blade is printed with letters of A1, A2, B1, and B2, in which, A1 = A2, B1 = B2, please install it correctly according to the diagram, otherwise it cannot take off.

4. Unfolding steps of the aircraft: (It is in the storage state when it leaves the factory)

1. Unfold the aircraft according to the steps

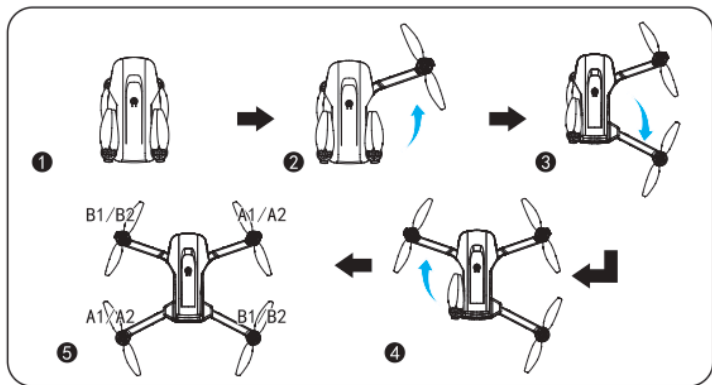

5. Lithium battery charging instructions:

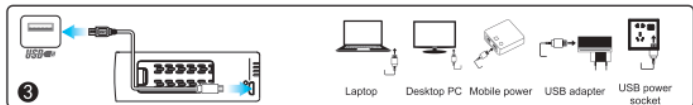

5.3 Charging: Insert the USB port of the USB charging cable into the computer USB port (or use 5V = 2A power adapter), and connect the other end of the USB charging cable to the battery socket. When charging, the red indicator on the module battery is on, and when the battery is fully charged, the red indicator light goes out, which means that the charging is complete.



It must be charged with the aircraft charging cable provided by the factory, and other charging cables cannot be used. Be sure to remember to avoid accidents.

6. Name of each part of the remote control:

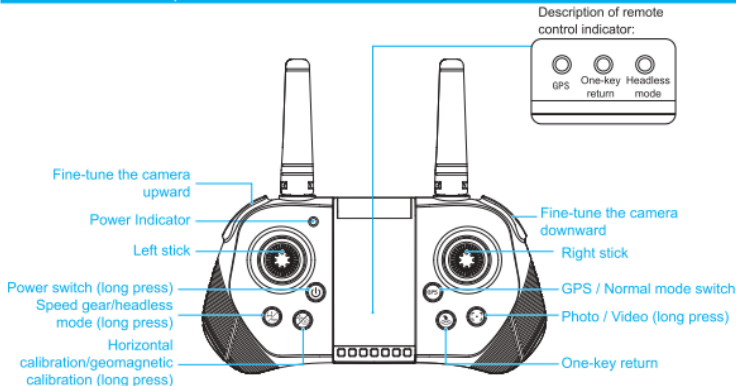

- Ⓜ Normal/GPS button: Press and hold this button for 3s after frequency matching to switch between normal mode and GPS mode (It is by default GPS mode after starting up, GPS indicator will be on, and when it enters normal mode, the indicator will be off).
- Ⓜ Headless mode button: long press this button to enter the headless mode, and the headless light will be on; press it again to exit the headless mode, and the headless light will be off.
- Ⓜ Return button: Press this button once to return home, and the return light will be on. Press again to cancel the returning, and the return light will be off.

7. Remote control battery installation:

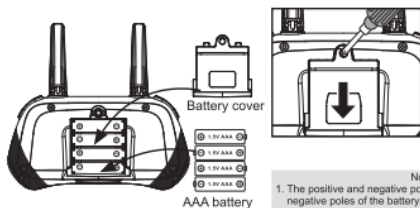

Battery installation:

- 7.1 Press the battery cover button with a screwdriver and remove the battery cover at the same time.
- 7.2 According to the polarity instructions on the battery compartment, remove the battery cover on the back and insert a 4X "AAA" battery (not included).

Note

1. The positive and negative poles and the positive and negative poles of the battery box must be identified when inserting the battery, and error is not allowed.
2. Do not mix old and new batteries.
3. Do not mix different types of batteries.

Instructions in charging:

- Do not put the charged battery in a place with high temperature and heat, such as an open flame or an electric heating device, otherwise damage or explosion may occur.
- Do not hit or beat the surface of hard objects with the battery.
- Do not disassemble the battery.
- Do not immerse the battery in water, and please store the battery in a dry place.
- Do not leave battery alone when charging.

Warning

When the aircraft is not in flying, disconnect the battery plug from the power connector of the aircraft circuit board to prevent the battery from being damaged.

8. APP download and installation instructions:

8.1 Download and install the software

For Google mobile phone, after scanning the code, choose to open and download in the browser



8.2 Link description

- ① Turn on the power of aircraft, enter the (Settings) option (of mobile phone or IPAD), and open the wireless network; find the device name of "4DRC_4K_GPS" in the wireless network search list and connect; after connection, exit the setting option.
- ② Open the software icon "4DRC PRO" in mobile phone to enter the control interface. (Try to stay away from other signal source environments when flying).



Open "4DRC PRO" software



Select Go to enter the control interface



Select and click "More Features"



Enter the function menu

9. APP control interface function introduction:





⚠ Note: The lens can be switched in indoor mode, and in GPS mode, the lens switch function will be turned off.

Novice mode

Flight distance, default
30m, (20m-2000m)

Flight altitude, default
30m, (10m-120m)

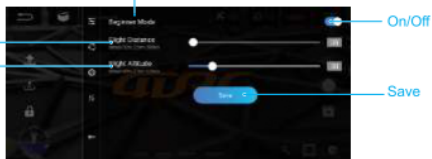

⚠ Note: After being proficient in flight operation, it is necessary to close the novice mode and set the flight distance and altitude before the aircraft can fly further!

10. Environmental requirements before flight:

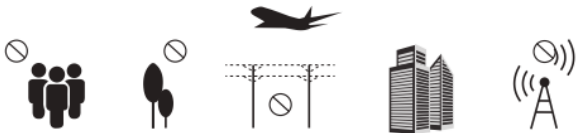

Please fly in an outdoor open environment without rain and snow, and with a wind power of less than 3. When flying, please stay away from people, trees, wires, tall buildings, airports and signal transmission towers.

11. Preparation instructions before flight

- 11.1 Aircraft frequency matching: Turn on the power of the aircraft and place it on a horizontal surface. At this time, the aircraft placed on the horizontal surface will automatically enter the frequency matching state, and the front blue light and the rear red light will flash.



- 11.2 Turn on the WiFi function in the mobile device, select "4DRC_4K_GPS" in the WiFi list, and open the APP after it connected successfully.



- 11.3 Turn on the remote control (default mode): long press the power switch button (1), turn on the power and the indicator flashes; push the throttle lever up to the top (step 2) and then to the bottom (step 3), and thus the frequency matching is successful, the UAV lights change from flashing to being permanently on.

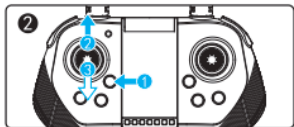

It must ensure that the power of the aircraft/remote control is sufficient or it cannot take off!

11.4 Horizontal calibration operation:

Short press the horizontal calibration button on the remote control , the blue and red lights on the aircraft will flash quickly. When the blue and red lights on the aircraft are always on, it will mean that the calibration is completed (Figure 1).

APP application operation: Click "Set more" icon in the APP interface, and follow the text prompt steps after entering, and it can also be horizontally calibrated (Figure 2).

⚠ Note: In calibration, the aircraft must be placed on a horizontal surface to complete the calibration.

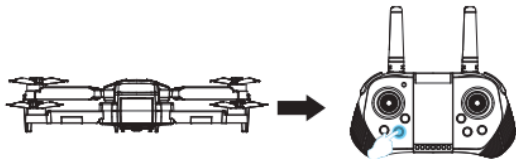

Figure 1

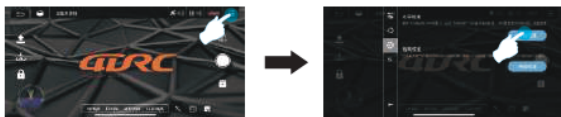

Figure 2

11.5 Geomagnetic calibration operation

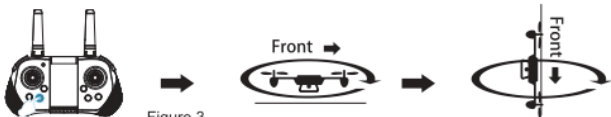



Figure 3

1. Long press the geomagnetic calibration key  until the front blue light and the rear red light flash on the aircraft.
2. Rotate horizontally clockwise to pick up the aircraft, rotate clockwise until the front blue light is always on and the rear red light flashes, and the remote control emits a beep, it means that the horizontal calibration is completed.
3. Rotate clockwise with the tail of the aircraft is upward-pick up the aircraft, with its nose being vertically down, and rotate clockwise until the blue light on the front and the red light on the rear of the aircraft are always on, and the remote control emits a beep, it means that the guide calibration is completed.

APP application operation: In entering the interface of "Setting more", according to the text prompt and operation steps, you can also guide the calibration (Figure 4).



Figure 4

11.6 Star search status (In GPS mode by default)

The remote control is in GPS mode and the GPS light is always on, which means that the GPS is in the state of star searching. When the red tail light of the aircraft flashes quickly, it means that the star searching succeeded, and the remote controller will emit a beep. The aircraft can be unlocked at this time (Figure 5).

⚠ Note: You need to wait at least a few minutes for the first search, and it can only take off when the aircraft's light and tail lights flash at the same time quickly!

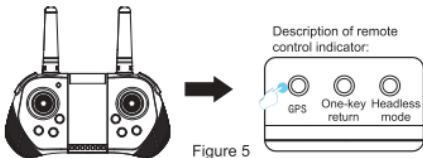

Figure 5

11.7 Start/stop (GPS mode)

Push the left and right joysticks on the remote control outward to unlock, (if the star search is unsuccessful, it cannot be unlocked and started) (Figure 6). At this time, the aircraft can take off normally. After taking off, all the indicators of the aircraft are always on.

APP operation: Click "One Key Unlock" icon (Figure 7) in APP control interface, the one-key unlock function can also be achieved.



Figure 6



Figure 7

11.8 Flight and landing

When unlocking is complete, push the throttle stick of the remote control upward, and the aircraft will take off. Pull the throttle stick of the remote control to the lowest position, and the aircraft will automatically land slowly (Figure 8).

APP application operation: Click the "one-button take-off" icon (Figure 9) in the control interface of APP, it can also take off; during the flight, click this icon again, the aircraft will automatically land slowly.



Figure 8



Figure 9

11.9 Normal mode (Optical flow assisted positioning)

The aircraft enters the normal mode: when the aircraft flies on a good ground, the optical flow will assist the aircraft, and hovering in a place shall be according to the ground and altitude conditions. It is normal to drift about 1 meter. In this mode, the height of the aircraft is limited to 10m.

11.10 Start / stop (common mode needs to be turned on for indoor operation)



Figure 10



Figure 11

1. Long press the GPS button (GPS) on the remote control, GPS indicator of the remote control will enter normal mode (Figure 10)

2. Push the left and right joysticks on the remote control outward to unlock (Figure 11)



Figure 12

3. Then push up the left joysticks (Figure 12)



Before flying, please perform the following steps in the above order: open (refer to 11.1) → link to WIFI (refer to 11.2) → remote control to start frequency matching (refer to 11.3) → horizontal calibration (refer to 11.4) → geomagnetic calibration (refer to 11.5) → Star search status (in GPS mode by default) (reference 11.6) → start/stop (GPS mode) (reference 11.7) → takeoff and landing (refer to 11.8) → normal mode (optical flow positioning) (refer to 11.9) → start/stop (it needs to open the normal mode for indoor operation) (refer to 11.10)

12. Control method:

APP application operation: Enter the APP control interface and click the "more functions" icon to open the "joystick on/off" icon, you can see the operation joystick on the interface. The operation method is as follows:



When the left joystick (throttle) is pushed up, the rotation rate of the main blade increases and the aircraft rises.
When the left joystick (throttle) is pushed down, the rotation rate of the main blade slows down and the aircraft descends.



When the left joystick (rudder) is pushed to the left, the aircraft nose turns to the left. When the left joystick (rudder) is pushed to the right and the nose of the aircraft will turn to the right.



When the right joystick (rudder) is pushed up, the aircraft moves forward.
When the right joystick (rudder) is pushed down, the aircraft moves backward.



When the right joystick (rudder) is pushed to the right, the aircraft fuselage deviates to the right.
When the right joystick (rudder) is pushed to the left, the aircraft fuselage deviates to the left.



When the aircraft is in 1m from the ground, the aircraft will become unstable due to the influence of its own blade vortex, which is called "ground effect response". The lower the height of the aircraft, the greater the effect of the ground effect response.

13. Introduction to the APP application and remote control function operation:

13.1 Headless mode

The front of the aircraft when it is in frequency matching shall be by default the front of the headless mode; if you need to adjust the direction, please restart the frequency matching, and long press the "headless mode"  function key (Figure 13) on the remote control. When exiting, please press this function key again.

 **Special prompt:** Please make sure the aircraft is aligned with the straight line and let the gyroscope automatically detect the straight line, and the headless mode of straight line flight can be realized.



Figure 13

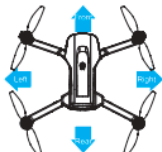
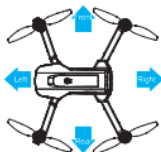

13.2 One key return

Press the one-key return button , the aircraft will return to the place above the geomagnetic calibration position (Figure 14). (The aircraft will automatically rise to a safe altitude when it is flying below the safe altitude) and then land slowly. If there are obstacles during the landing, press the one-key return button again to turn off the return operation and avoid by the manual control joystick, pull down the throttle lever to land.

APP operation: Click the "one-key return" icon (Figure 15) in the APP control interface, you can also return the aircraft; during the return flight, click this icon again to cancel the return.



Figure 14



Figure 15



Runaway return: When the signal of the remote controller is interrupted for about 4s, the aircraft will automatically return to the place where there is a signal and stop. **Low battery return:** when the aircraft is in low battery electricity, it will forcefully return to a place that is 20m above the take-off point. The return flight cannot be cancelled during the low battery return.

13.3 Speed switching

✂ When the aircraft takes off, it is in low-speed mode (shifting gears) by default; lightly press the remote control, it will emit two sounds of "beep", it will enter "high-speed gear". (Figure 16)

APP operation: Click the "More Functions" icon (Figure 17) in the APP control interface, and the flight speed can also be switched (Figure 18).



Figure 16



Figure 17



Figure 18

13.4 Waypoint flight mode

① In GPS mode, click "More Functions" icon (Figure 19) in the APP control interface to enter waypoint flight (Figure 20). At this time, the interface changes from the image transmission page to the map page. On the map page, click to set the track range of a single waypoint or continuous waypoints (Figure 21). During the setting process, if the track waypoints are too dense, you can click the delete icon to delete all waypoints (Figure 22).

② After setting of the waypoint, click the send icon (Figure 23), the aircraft will fly to all waypoints from the initial point to complete the preset flight trajectory. The direction of the aircraft can be controlled by the joystick during the flight.



Figure 19



Figure 20



Figure 21



Figure 22



Figure 23

13.5 Orbital flight mode

In GPS mode, click "More Features" icon in the APP control interface (Figure 24) to enter the orbit flight mode (Figure 25), the aircraft will automatically orbit in a radius (Figure 26), and the radius can be adjusted on the APP (Figure 27). At this time, push the right direction joystick to fly left or right (Figure 28) at the default speed, the orbital speed can be adjusted. Push the right direction joystick front or rear, the orbit radius can be adjusted, and when the orbit button is pressed again, the orbit flight will end (Figure 29).



Figure 24



Figure 25



Figure 26

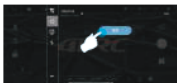

Figure 27



Figure 28



Figure 29

13.6 GPS follow mode

In GPS mode, click the "More Functions" icon (Figure 30) in the APP control interface to enter the follow (Figure 31). The aircraft will use the distance from the current position to the operator (mobile phone or IPAD) device as a reference, and move by tracking changes in the location of mobile devices. In following, lightly press the red ⊗ icon to cancel the following.



Figure 30



Figure 31

13.7 Lens adjustment

Press the fine adjustment button for the camera angle on the remote control, and the operator can adjust the lens angle as needed (Figure 32).

APP application operation: Click on the "More Functions" icon (Figure 33) in the APP control interface to enter the lens adjustment (Figure 34), and the operator can adjust the lens angle as needed (Figure 35).

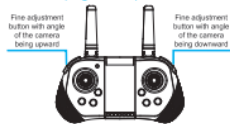

Figure 32



Figure 33



Figure 34



Figure 35



13.8 Gesture Recognition

When facing the camera's front lens, click the gesture photo button on the APP, and use any of the following gestures to trigger the aircraft's photo or camera function.

⚠ Special Tip: Please face the lens with the front being at a position about 2-3M away and in a better light and background environment to perform the gesture recognition.



Yeah gesture photo

In about 3m front of the aircraft lens, make Yeah gesture with one hand in horizontal position; after the aircraft successfully recognizes the gesture, count down 3 seconds and take photos.



Palm gesture video-recording

In about 3m front of the aircraft lens, put five fingers together and lift one hand to horizontal position; after the aircraft successfully recognizes the gesture, it will start recording. The recording will end when the gesture is re-recognized (the time difference between the two recognitions shall be greater than 3s).

13.9 MV interface

Click the "filter interface" icon (Figure 36) in the APP control interface, after entering the filter interface, you can choose to match your favorite filter effect, click the recording icon to start recording (Figure 37). After the recording is completed, the synthesized short video or picture will be saved to the media library (Figure 38).

⚠ Special Tip: During the recording process, you can rotate the screen or switch the filter effect, and you can also turn the joystick on / off to control the direction and altitude of the aircraft.



Figure 36



Figure 37



Figure 38

14. FAQ and solving guidelines:

Question	Reason	Solution
The aircraft indicator flashes without any response	1. Geomagnetic anomaly 2. The aircraft has insufficient power	1. Move the aircraft to an open place and search for stars again 2. Charge the battery
The blades of the aircraft rotate but cannot fly	1. Low battery 2.1 Blade deformation 2.2 Installation error of AB propeller	1. Charge the battery 2.1 Replace the blade 2.2 The fan blades are printed with letters A and B. For fan blade A or B, replace the one that is broken.
The aircraft vibrates badly	Blade deformation	Replace the blade
After the impact, start the aircraft again and it fly uncontrollably	The three-axis acceleration sensor loses its balance due to impact	After leaving the aircraft for 5-10 seconds, or by the horizontal calibration, it will be ok. For the steps, please refer to the manual, 11.4 horizontal calibration operation.