

4D-F11

Suitable for ages over 14

Quadcopter operating instructions



English

- In order to meet the requirements of the aeronautical radio station's electromagnetic environment (various of aero models and UAV are not allowed to fly within the range of 10 km on each side of center line and 20km on both ends of the airport runway and in the) and civil aviation routes and airlines. Using various models and drones in the no-fly zone issued by the relevant state departments is prohibited.

Warning

1. The packaging and instructions contain important information and should be kept.
2. With this aircraft, you are responsible for ensuring that no harm will be caused to the personal and property of others.
3. Commissioning and installing of aircraft must be strictly in accordance with the operating instructions, and attention shall be paid to the distance between the aircraft and the user or other people shall be 2 to 3m to prevent the aircraft from bumping into the head, face and body of people and causing injury in flying and landing, etc.
4. Our company and distributors are not responsible for any loss and damage, as well as injury to people caused by improper use or operation.
5. Children should be guided by adults when operating the aircraft. This product is prohibited to be operated by children under 14 years old.
6. Please follow the instructions or packaging instructions to install and use correctly, and some parts should be assembled by adults.
7. The product contains small parts, please place it out of the reach of children to prevent the risk of accidental eating or suffocation.
8. It is strictly forbidden to play on the road or in the place where water is accumulated to avoid accidents.
9. Please put away the packing materials in time to avoid harm to children.
10. Do not disassemble or modify the aircraft. Disassembly or modification may cause malfunction to the aircraft.
11. The charging cable needs to be inserted into the designated power supply 5V $\overline{\text{---}}$ 2A that is the same as the product label.
12. The use of other charging cables will cause damage to the battery and may cause unexpected dangers.
13. The charging cable is not a toy.
14. When charging the rechargeable battery, it must be under the supervision of an adult. When charging, it must be far away from flammable materials. During charging, the guardian should not leave the monitoring range.
15. Please do not short circuit or squeeze the battery to avoid explosion.
16. Do not mix different types of lithium batteries.
17. The aircraft uses a rechargeable lithium battery, which needs to be pulled out for charging.
18. Do not short-circuit, decompose or throw the battery into fire; do not put the battery in a place with high temperature and heat (such as in fire or near electric heating device).
19. The aircraft should be used as far away from other electrical equipment and magnetic objects as possible, they may cause mutual interference.
20. Please keep a safe distance from the high-speed rotating propeller to avoid the risk of scalp or cut
21. The motor is a hot part; please do not touch it to avoid burns.
22. LED has laser radiation; please do not give direct light beam to others.
23. Do not use the model near your ears! Misuse may cause hearing damage.
24. The USB charging cable must use the data cable provided by our company to charge the battery, otherwise it will cause serious damage to the battery and will lead to unexpected danger.
25. To meet the magnetic environment requirements of aeronautical radio stations. During the radio control order issued by the relevant state departments, the model remote control should be stopped within the city area as required.
26. Turn off the switch and unplug the battery when the battery of the aircraft is used up, and charge after 30 minutes of rest, otherwise the battery will be easily damaged.

1. List of accessories included:



Aircraft ×1



USB charging cable ×1



Fan blade ×2



Lithium battery ×1



Screwdriver ×1



Operating Instructions ×1

2. Name of each part of aircraft:

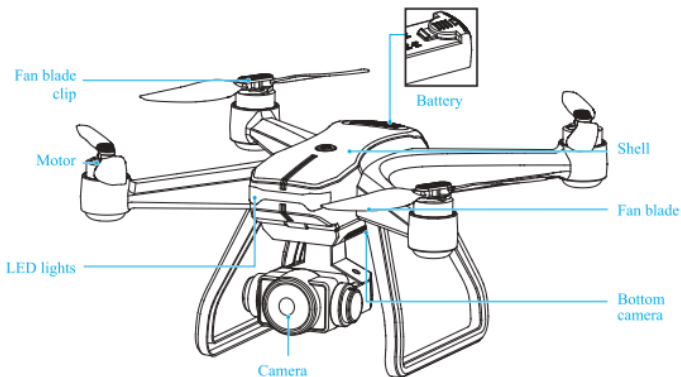

3. The installation steps of the aircraft camera:

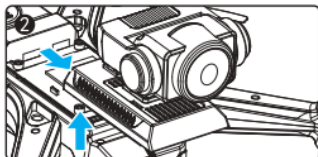
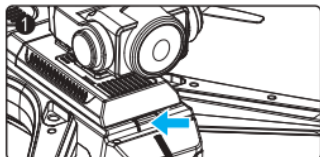

Press the lock as shown in the figure to push the camera out of the card slot and take out the camera upwards at the same time.

⚠ Note: Make sure the installation is in place before flying to avoid falling during the flight.

4. Wind blade installation diagram:

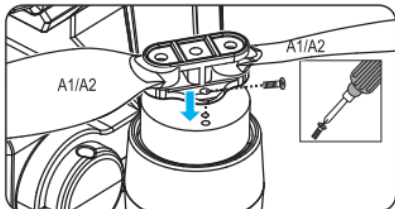
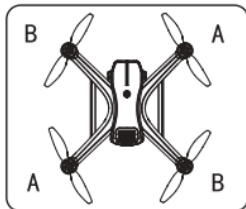

Unscrew the screw and remove the fan blade.

⚠ Note: The fan blade is printed with letters of A1, A2, B1, and B2, in which, A1 = A2, B1 = B2, please install it correctly according to the diagram, otherwise it cannot take off

5. Landing gear installation diagram:

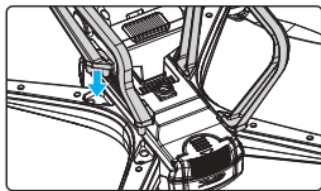

Align the landing gear components with the sockets on the bottom of the aircraft according to the diagram, and then make sure they are installed in place before flying to avoid falling during the flight.

⚠ Note: The landing gear enables the aircraft to take off smoothly on the ground. Please be sure to install the landing gear before flying!

6. Lithium battery charging instructions:

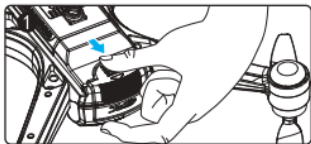

6.1 Buckle the battery lock of the aircraft.

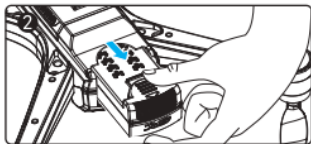

6.2 Remove the battery.

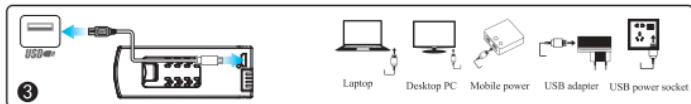

6.3 Charging: Insert the USB port of the USB charging cable into the computer USB port (or use 5V \approx 2A power adapter), and connect the other end of the USB charging cable to the battery socket. When charging, the red indicator on the module battery is on, and when the battery is fully charged, the red indicator light goes out, which means that the charging is complete.



It must be charged with the aircraft charging cable provided by the factory, and other charging cables cannot be used. Be sure to remember to avoid accidents.

7. Name of each part of the remote control:

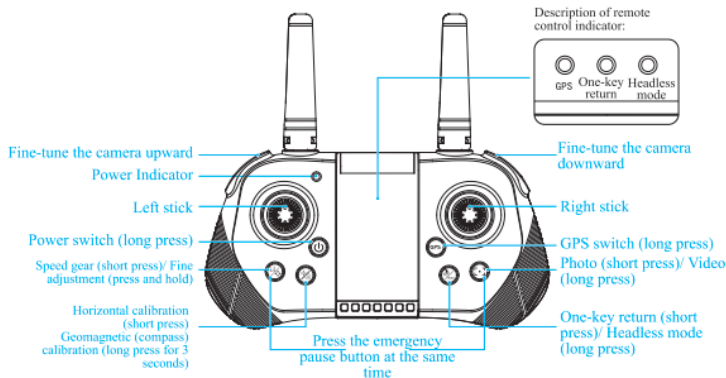

Ⓞ Normal/GPS button: Press and hold this button for 3s after frequency matching to switch between normal mode and GPS mode (It is by default GPS mode after starting up, GPS indicator will be on, and when it enters normal mode, the indicator will be off).

Ⓞ Press this button once to return home, and the return light will be on. Press again to cancel the returning, and the return light will be off. long press this button to enter the headless mode, and the headless light will be on; press it again to exit the headless mode, and the headless light will be off.

8. Remote control battery installation:

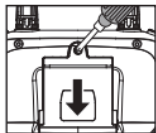
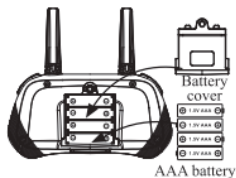

Battery installation:

- 8.1 Press the battery cover key with a screwdriver and remove the battery cover at the same time.
- 8.2 According to the polarity instructions on the battery compartment, remove the battery cover on the back and insert a 4X "AAA" battery (not included).

Instructions in charging:

- Do not put the charged battery in a place with high temperature and heat, such as an open flame or an electric heating device, otherwise damage or explosion may occur.
- Do not hit or beat the surface of hard objects with the battery.
- Do not disassemble the battery.
- Do not immerse the battery in water, and please store the battery in a dry place.
- Do not leave battery alone when charging.

Note

1. The positive and negative poles and the positive and negative poles of the battery box must be identified when inserting the battery, and error is not allowed.
2. Do not mix old and new batteries.
3. Do not mix different types of batteries.

9. APP download and installation instructions:

9.1 Download and install the software

For Google mobile phone, after scanning the code, choose to open and download in the browser



Google system: Please scan this QR code to install



IOS system: please scan this QR code to install

9.2 Link description

- ① Turn on the power of aircraft, enter the (Settings) option (of mobile phone or IPAD), and open the wireless network; find the device name of "4DRC*****" in the wireless network search list and connect; after connection, exit the setting option.
- ② Open the software icon of "4DRC PRO" in mobile phone to enter the control interface. (Try to stay away from other signal source environments when flying)



Open the "4DRC PRO" software



Select Go to enter the control interface



Select and click "More Features"



Enter the function menu

10. APP control interface function introduction:



⚠ Note: The lens can be switched in indoor mode, and in GPS mode, the lens switch function will be turned off.



⚠ Note: After being proficient in flight operation, it is necessary to close the novice mode and set the flight distance and altitude before the aircraft can fly further!

11. Environmental requirements before flight:

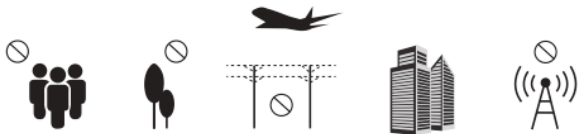

Please choose to fly in an outdoor open environment without rain and snow, and the wind power of less than level 3. When flying, please stay away from people, trees, wires, tall buildings, airports and signal transmission towers. Do not fly indoors or in environments with weak GPS signals.

12. Preparation instructions before flight

12.1 Aircraft frequency matching: Turn on the power of the aircraft and place it on a horizontal surface. At this time, the aircraft placed on the horizontal surface will automatically enter the frequency matching state, and the front blue light and the rear red light will flash.

Set the aircraft in a correct direction, and the nose shall face forward. It must be placed on the horizontal plane.

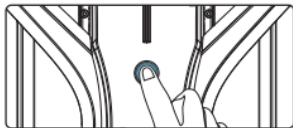

12.2 Turn on the WiFi function in the mobile device, select "4DRC*****" in the WiFi list, and open the APP after it connected successfully.

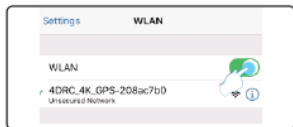

12.3 Turn on the remote controller (default mode)-Long press the power switch button of the remote controller (step 1) ①, turn on the power indicator of the remote controller to flash, push the throttle lever upward to the top (step 2) and then push it to the end (step 3). The frequency is successfully matched, and the unmanned plane lamp will not flash and turn on normally.

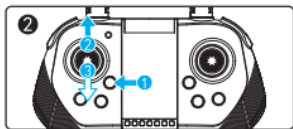

The aircraft/remote controller must ensure sufficient power or it cannot take off!

12.4 Horizontal calibration operation:

Short press the horizontal calibration button on the remote control , the blue and red lights on the aircraft will flash quickly. When the blue and red lights on the aircraft are always on and the calibration is complete (Figure 1).

APP application operation: Click "Set more" icon in the APP interface, and follow the text prompt steps after entering, and it can also be horizontally calibrated (Figure 2).

 **Note:** In calibration, the aircraft must be placed on a horizontal surface to complete the calibration.

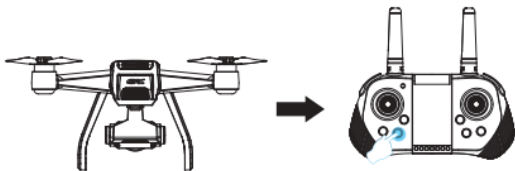

Figure 1



Figure 2

12.5 Geomagnetic calibration operation

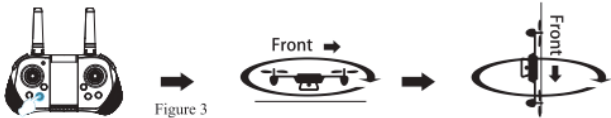



Figure 3

1. Long press the geomagnetic calibration button  until the front blue light and the rear red light on the aircraft flash slowly.
2. Horizontal clockwise rotation - pick up the aircraft horizontally, and rotate it clockwise until the front blue light is always on and the rear tail red light flashes slowly, and the remote control beeps once, which means the level calibration is completed.
3. Rotate clockwise with the tail of the aircraft is upward -pick up the aircraft, with its nose being vertically down, and rotate clockwise until the blue light on the front and the red light on the rear of the aircraft are always on, and the remote control emits a beep, it means that the guide calibration is completed.

APP application operation: In entering the interface of "Setting more", according to the text prompt and operation steps, you can also guide the calibration (Figure 4).



Figure 4

12.6 Star search status (In GPS mode by default)

The remote control is in GPS mode and the GPS light is always on, which means that the GPS is in the state of star searching. When the red tail light of the aircraft flashes quickly, it means that the star searching succeeded, and the remote controller will emit a beep. The aircraft can be unlocked at this time (Figure 5).

Note: You need to wait at least a few minutes for the first search. It can take off when the search signal reaches 3 blocks or more.

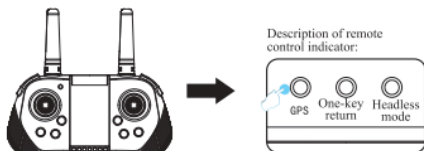

Figure 5

12.7 Start/stop (GPS mode)

Push the left and right joysticks on the remote control outward to unlock, (if the star search is unsuccessful, it cannot be unlocked and started) (Figure 6). At this time, the aircraft can take off normally. After taking off, all the indicators of the aircraft are always on.

APP operation: Click "One Key Unlock" icon (Figure 7) in APP control interface, the one-key unlock function can also be achieved.



Figure 6

Figure 7

12.8 One-key take-off and landing

APP operation: Click "one-key take-off" icon (Figure 8) in APP control interface, the one-key take-off function can also be achieved; during flight, click this icon again, the aircraft will automatically land slowly.



Figure 8

12.9 Normal mode

The aircraft enters the normal mode

12.10 Start / stop (common mode needs to be turned on for indoor operation)



Figure 9



Figure 10



Figure 11

1. Long press the GPS button (GPS) on the remote control, GPS indicator of the remote control will enter normal mode (Figure 9)
2. Push the left and right joysticks on the remote control outward to unlock (Figure 10)
3. Then push up the left joysticks (Figure 11)



Before flying, please perform the following steps in the above order: open (refer to 12.1) → link to WIFI (refer to 12.2) → remote control to start frequency matching (refer to 12.3) → horizontal calibration (refer to 12.4) → geomagnetic calibration (refer to 12.5) → Star search status (in GPS mode by default) (reference 12.6) → start/stop (GPS mode) (reference 12.7) → One-key take-off and landing (refer to 12.8) → normal mode (refer to 12.9) → start/stop (it needs to open the normal mode for indoor operation) (refer to 12.10)

13. Control method:

APP application operation: Enter the APP control interface and click the "more functions" icon to open the "joystick on/off" icon, you can see the operation joystick on the interface. The operation method is as follows:



When the left joystick (throttle) is pushed up, the rotation rate of the main blade increases and the aircraft rises.

When the left joystick (throttle) is pushed down, the rotation rate of the main blade slows down and the aircraft descends.



When the left joystick (rudder) is pushed to the left, the aircraft nose turns to the left.

When the left joystick (rudder) is pushed to the right and the nose of the aircraft will turn to the right.



When the right joystick (rudder) is pushed up, the aircraft moves forward.

When the right joystick (rudder) is pushed down, the aircraft moves backward.



When the right joystick (rudder) is pushed to the right, the aircraft fuselage deviates to the right.

When the right joystick (rudder) is pushed to the left, the aircraft fuselage deviates to the left.



When the aircraft is in 1m from the ground, the aircraft will become unstable due to the influence of its own blade vortex, which is called "ground effect response". The lower the height of the aircraft, the greater the effect of the ground effect response.

14. Introduction to the APP application and remote control function operation:

14.1 Headless mode

 The front of the aircraft when it is in frequency matching shall be by default the front of the headless mode; if you need to adjust the direction, please restart the frequency matching, and long press the "headless mode" function key (Figure 12) on the remote control. When exiting, please press this function key again.



 **Special prompt:** Please make sure the aircraft is aligned with the straight line and let the gyroscope automatically detect the straight line, and the headless mode of straight line flight can be realized.



Figure 12

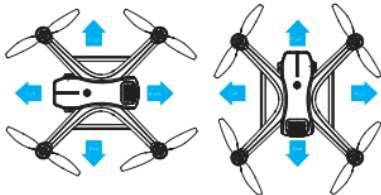

14.2 One-key return

Press the one-key return button , the aircraft will return to the place above the geomagnetic calibration position (Figure 13). (The aircraft will automatically rise to a safe altitude when it is flying below the safe altitude) and then land slowly. If there are obstacles during the landing, press the one-key return button again to turn off the return operation and avoid by the manual control joystick, pull down the throttle lever to land.

APP operation: Click the "one-key return" icon (Figure 14) in the APP control interface, you can also return the aircraft; during the return flight, click this icon again to cancel the return.



Figure 13



Figure 14



Runaway return: When the signal of the remote controller is interrupted for about 4s, the aircraft will automatically return to the place where there is a signal and stop. **Low battery return:** when the aircraft is in low battery electricity, it will forcefully return to a place that is 20m above the take-off point. The return flight cannot be cancelled during the low battery return.

14.3 Speed switching

✂ When the aircraft takes off, it is by default in the low-speed mode (2-gear switching); gently press the remote control by a "beep" sound for low-speed gear, two "beep" sounds for medium-speed gear (Figure 15).

APP operation: Click the "More Functions" icon (Figure 16) in the APP control interface, and the flight speed can also be switched (Figure 17).



Figure 15



Figure 16



Figure 17

14.4 Waypoint flight mode

① In GPS mode, click "More Functions" icon (Figure 18) in the APP control interface to enter waypoint flight (Figure 19). At this time, the interface changes from the image transmission page to the map page. On the map page, click to set the track range of a single waypoint or continuous waypoints (Figure 20). During the setting process, if the track waypoints are too dense, you can click the delete icon to delete all waypoints (Figure 21).

② After setting of the waypoint, click the send icon (Figure 22), the aircraft will fly to all waypoints from the initial point to complete the preset flight trajectory. The direction of the aircraft can be controlled by the joystick during the flight.



Figure 18



Figure 19



Figure 20



Figure 21



Figure 22

14.5 Orbital flight mode

In GPS mode, click "More Features" icon in the APP control interface (Figure 23) to enter the orbit flight mode (Figure 24), the aircraft will automatically orbit in a radius (Figure 25), and the radius can be adjusted on the APP (Figure 26). At this time, push the right direction joystick to fly left or right (Figure 27) at the default speed, the orbital speed can be adjusted. Push the right direction joystick front or rear, the orbit radius can be adjusted, and when the orbit button is pressed again, the orbit flight will end (Figure 28).



Figure 23



Figure 24



Figure 25



Figure 26



Figure 27



Figure 28

14.6 GPS follow mode

In GPS mode, click the "More Functions" icon (Figure 29) in the APP control interface to enter the follow (Figure 30). The aircraft will use the distance from the current position to the operator (mobile phone or IPAD) device as a reference, and move by tracking changes in the location of mobile devices. In following, lightly press the red ⊗ icon to cancel the following.



Figure 29



Figure 30

14.7 Lens adjustment

Press the fine adjustment button for the camera angle on the remote control, and the operator can adjust the lens angle as needed (Figure 31).

APP application operation: Click on the "More Functions" icon (Figure 32) in the APP control interface to enter the lens adjustment (Figure 33), and the operator can adjust the lens angle as needed (Figure 34).

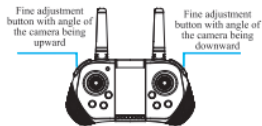

Figure 31



Figure 32



Figure 33



Figure 34

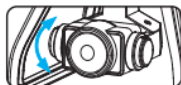

14.8 Gesture recognition

When facing the camera's front lens, click the gesture photo button on the APP, and use any of the following gestures to trigger the aircraft's photo or camera function. **Special Tip: Please face the lens with the front being at a position about 2-3M away and in a better light and background environment to perform the gesture recognition.**

Yeah gesture photo



In about 3m front of the aircraft lens, make Yeah gesture with one hand in horizontal position; after the aircraft successfully recognizes the gesture, count down 3 seconds and take photos.

Palm gesture video-recording



In about 3m front of the aircraft lens, put five fingers together and lift one hand to horizontal position; after the aircraft successfully recognizes the gesture, it will start recording. The recording will end when the gesture is re-recognized (the time difference between the two recognitions shall be greater than 3s).

14.9 MV interface

Click the "filter interface" icon (Figure 35) in the APP control interface, after entering the filter interface, you can choose to match your favorite filter effect, click the recording icon to start recording (Figure 36). After the recording is completed, the synthesized short video or picture will be saved to the media library (Figure 37).

Tips: During the recording process, you can rotate the screen or switch the filter effect, and you can also turn the joystick on / off to control the direction and altitude of the aircraft.



Figure 35



Figure 36



Figure 37

15. FAQ and solving guidelines:

Question	Reason	Solution
The aircraft indicator flashes without any response	<ol style="list-style-type: none">1. Geomagnetic anomaly2. The aircraft has insufficient power	<ol style="list-style-type: none">1. Move the aircraft to an open area and recalibrate the geomagnetism. For steps, please refer to the manual, 12.5 Geomagnetism Calibration.2. Charge the battery
The blades of the aircraft rotate but cannot fly	<ol style="list-style-type: none">1. Low battery2. 1 Blade deformation2.2 Installation error of AB propeller	<ol style="list-style-type: none">1. Charge the battery2.1 Replace the blade2.2 If B1/B2 blade is broken, replace B1/B2. If A1/A2 blade is broken, replace A1/A2. If replace the wrong parts, the aircraft will not take off.
The aircraft vibrates badly	Blade deformation	Replace the blade
Fine tuning is done but still can't make the aircraft stable	<ol style="list-style-type: none">1. Blade deformation2. Defective motor	<ol style="list-style-type: none">1. Replace the blade2. Replace the motor
After the impact, start the aircraft again and it fly uncontrollably	The three-axis acceleration sensor loses its balance due to impact	It will be OK after 5-10s of resting the aircraft, or by geomagnetism calibration and level calibration. For the steps, please refer to the manual, 12.4 horizontal calibration operation.