



Cetus Pro

FPV KIT

User Manual

Contents

1.Product List	3
2.Preflight Checks	4
3.Quick Start Guide	5
3.1 Quick Start	5
3.2 Flight Operation	7
3.3 First Person View (FPV)	9
3.4 On-Screen Display (OSD)	9
3.5 Flight Modes	10
3.6 Battery Charging	11
4.Remote Control Radio Transmitter	13
4.1 Switch Functions	14
4.2 Joystick Functions	15
4.3 Button Functions	16
4.4 Charging the Remote Control Radio Transmitter	16
5.FPV Goggles	18
5.1 Button Operation	19
5.2 Frequency Selection	21
5.3 Charging the FPV Goggles	22
6.Quadcopter OSD Menu Operation	23
6.1 How to Access/Operate OSD Setting Menu	23
6.2 Turn Quadcopter RGB LED ON/OFF	25
6.3 Customizing OSD Flight Information	25

7.LED Light/Beep Status Codes	27
7.1 Quadcopter LED Light	27
7.2 Remote Control Radio Transmitter LED Light & Beep Status Codes	29
7.3 FPV Goggles LED Light Status Codes	30
8.Advanced Settings	31
8.1 Turtle Mode	31
8.2 Re-Bind for Quadcopter	32
8.3 Quadcopter Level Calibration	33
8.4 Remote Control Radio Transmitter Calibration	34
8.5 Turn OFF/ON the Optical Flow Positioning Function	34
8.6 Turn OFF/ON Laser Altitude Determination	35
9.Supplement	36
9.1 Warning & Security	36
9.2 Precautions for Battery Use and Charging	36
9.3 After-Sale Service	37
10.FAQ	38
10.1 How to Replace Propellers	38
10.2 How to Adjust When the Quadcopter Drifts or When It's Difficult to Control in Normal Mode	38
10.3 How to Use FPV Simulator	40
10.4 How to Stop After A Collision	41

1.Product List

- 1 x Cetus Pro Brushless Quadcopter
- 1 x LiteRadio 2 SE Transmitter (Frsky Protocol)
- 1 x BEATFPV VR02 FPV Goggles

Box Contents:

- 2 x BT2.0 450 mAh 1S Lipo Battery
- 1 x BT2.0 Battery Charger and Voltage Tester
- 1 x USB Charging Cable (Type-C)
- 1 x Type-C to FC Adapter
- 1 x Prop Removal Tool
- 4 x 40mm 3-Blade Prop (Replacement)
- 1 x Portable Storage Bag

2.Preflight Checks

1. Verify that all components are included, without damage and the airframe is with no deformation.
2. Verify that propellers and motors are installed correctly and stably.
3. Ensure that propellers do not scratch against frame ducts and motors spin smoothly.
4. Verify batteries (of quadcopter, remote control radio transmitter, and FPV goggles) are fully charged.
5. Be sure pilot is familiar with all flight controls. (Refer "Remote Control Radio Transmitter").
6. Always keep a safe distance in all directions around the quadcopter (1 meter or more) when having a test-flight. Operate the quadcopter carefully in open space.

3.Quick Start Guide

3.1 Quick Start

Before flying, verify that the remote control radio transmitter is successfully connected with the quadcopter, all basic controls are functional, and the quadcopter can be taken off normally.

- Step 1: On the remote control radio transmitter, set the throttle joystick and four switches on the top to the lowest position. Long press the power button on the remote control radio transmitter for 5 seconds until it beeps three times, then release. The remote control radio transmitter power indicator will flash red quickly, then remain blue, which means powered on.

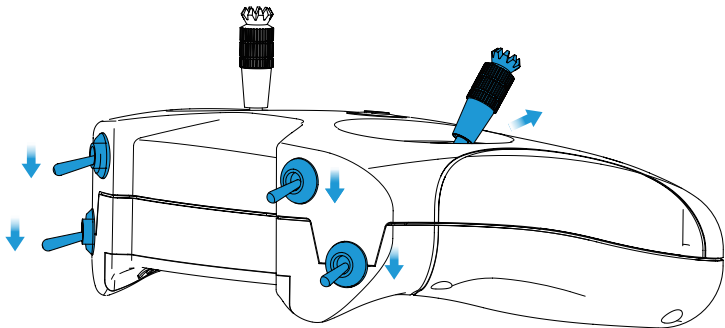

Set the Throttle Joystick and Four Switches to the Lowest Position

- Step 2: Install the battery into the battery mounting slot under the quadcopter. Ensure that the direction of the battery interface and that of the quadcopter power cord is consistent. Connect the quadcopter with the battery, then place the quadcopter on a horizontal surface. Wait 3-5 seconds until its status LED lights change from flashing blue to solid blue. This indicates that the initialization of the quadcopter is complete and the quadcopter is connected successfully with the remote control radio transmitter.

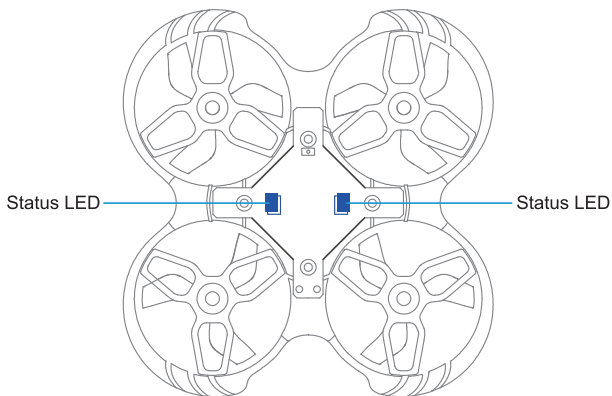

- Step 3: Move switch SA up to arm the quadcopter. The throttle joystick must be at the lowest position or the quadcopter will not arm. The motors will spin slowly. Move switch SA down to disarm the quadcopter and the motors will stop spinning.

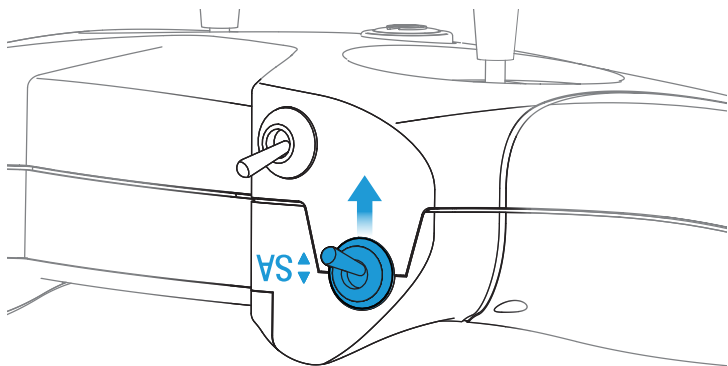

Push Up to Arm the Quadcopter

The completion of these steps verifies that the quadcopter and the remote control radio transmitter can work normally, and the following flight operations can be continued.

3.2 Flight Operation

- Step 4: Re-arm quadcopter (step 3). Motors will spin at a low speed.

Throttle (left) Joystick:

- Up/down controls rate of ascent/ descent.
- Left/Right controls counterclockwise/ clockwise rotation.

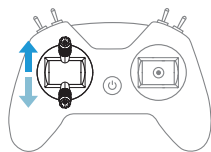

Joystick up/down

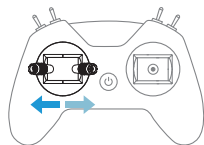
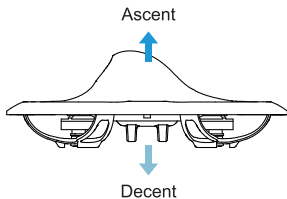

Joystick left/right

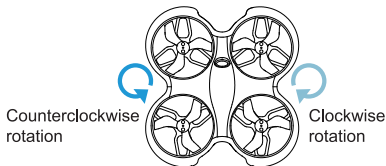

Direction (right) Joystick:

- Up/down controls forward/ backward.
- Left/right controls left/ right.

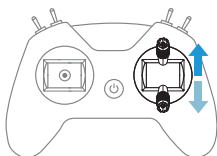

Joystick up/down

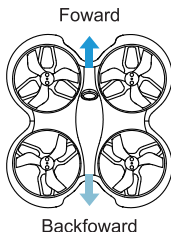

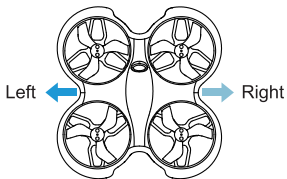
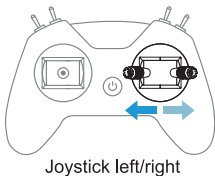

Before flying with goggles, it is recommended to practice and become familiar with the controls and sensitivity of the joysticks by following the above-mentioned operation steps.

Caution:

1. Find a suitable open place for the first flight.
2. Push the joysticks slowly, especially the throttle joystick.
3. If the quadcopter becomes out of control or collides with objects, disarm the quadcopter quickly (push switch SA down) and motors will stop spinning.

- Step 5: Land quadcopter steadily and keep it disarmed (push switch SA down), as shown below:

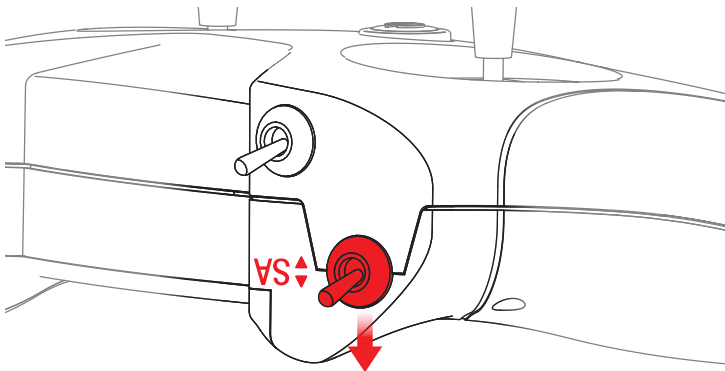

Push Down to Disarm the Quadcopter

- Step 6: Disconnect and remove the battery from the quadcopter. A long press of the power button on the remote control radio transmitter will turn it off after three beeps.

3.3 First Person View (FPV)

First Person View (FPV) is the real-time transmission of the camera image to FPV goggles.

- Take out the goggles, install the headband;
- Slide the power switch to the right. The screen lights up and the VR02 goggles are turned on;
- Long press the “S” button for 1 second to turn on the fast frequency search function. After 3 seconds, a beep will sound and the corresponding FPV cross-machine screen is displayed in the goggles, indicating that the frequency search is complete.

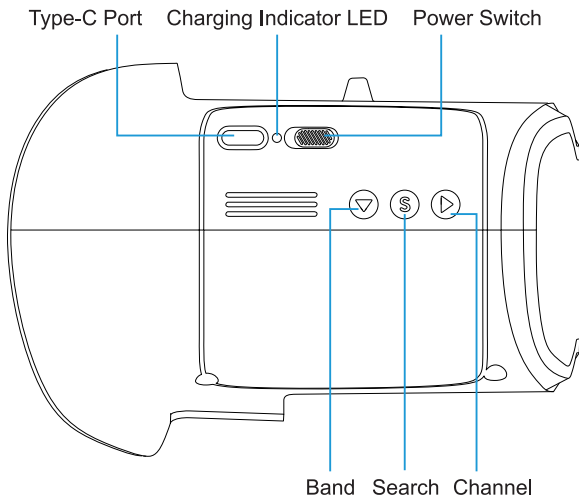

3.4 On-Screen Display (OSD)

After the frequency search, flight information and FPV images will be shown on the display. This information is called On-Screen Display (OSD), as shown below:

Status: Disarm

DISARM

V3.89
00.00

S MODE
SLOW

Flight Time

Quad Battery Voltage

Flight Mode

Speed Threshold

About OSD information:

- The flight status of the quadcopter is displayed in the center. DISARM indicates locked status. TURTLE indicates that the Turtle Mode is activated; LOW VOL indicates that the battery voltage of the quadcopter is low. RX LOSS indicates that the quadcopter has been disconnected with the remote control radio transmitter.
- Status of the quadcopter is displayed in the bottom of the screen, including the receiver protocol, quad battery voltage, flight time, flight mode, and speed threshold.

3.5 Flight Modes

The flight mode is displayed in the lower right corner of the flight screen, corresponding to the flight mode of quadcopter. Pilot can choose different flight modes according to different flight environments and their flight control skills.

1. Normal Mode: When the quadcopter ascends, center the two joysticks at the same time, and the quadcopter will maintain at a fixed point in a horizontal attitude. The position of the direction joystick controls the tilt direction and tilt angle of the quadcopter.

The quadcopter has an auxiliary flight function that can assist in adjusting the altitude and horizontal position, which makes it easier for pilot to control. N MODE is displayed in the OSD.

2. Sport Mode: When the quadcopter ascends, pilot needs to operate the throttle joystick to control and adjust the altitude of the quadcopter. The position of the direction joystick controls the tilt direction and tilt angle of the quadcopter. When the direction joystick is moved back to the center, the quadcopter will return to a horizontal attitude. The quadcopter has no auxiliary flight function, which makes the operation relatively difficult for pilot. S MODE is displayed in the OSD.

3. Manual Mode: When the quadcopter ascends, pilot needs to operate the throttle joystick to control and adjust the flight altitude. Position of the direction joystick controls the roll direction and the roll speed of the quadcopter. The quadcopter will maintain its current attitude when the direction joystick is moved to the center. The quadcopter has no auxiliary flight function, and the flight attitude and altitude are completely dependent on the pilot to control the quadcopter by the remote control radio transmitter, which makes the operation very difficult for pilot. M MODE is displayed in the OSD.

4. Turtle Mode: If the quadcopter crashes into the ground and the fuselage is flip, the turtle mode can be activated to reverse the motor and turn the quadcopter back to the front. When in use, the direction joystick is used to control the rotation of the motor to drive the blades to rotate in the reverse direction, thereby realizing the reverse rotation of the fuselage. TURTLE is displayed in the center of the OSD. For more details, please refer to the chapter "Advanced Settings-Turtle Mode".

The flight mode is selected by a switch on the remote control radio transmitter. For more details, please refer to the chapter "Remote Control Radio Transmitter-Switch Functions".

Caution: Please keep the flight altitude within 0.3-3m when it is in Normal Mode. This can keep the quadcopter fly stably. The outdoor flying height of the quadcopter should not exceed 3m as far as possible.

3.6 Battery Charging

Each battery provides 4-5 minutes of smooth flight. When LOW VOL is displayed in the OSD flight interface and the status LED on the quadcopter changes to flashing red, which indicates that the battery is too low and needs to be charged.

Charging steps are as follows:

- Plug the charger into the Type-C port through USB cable;

- Connect one or two batteries to the port on the right of the charger and the charger's LED turns solid red when charging;
- When the charger's LED turns solid green, charging is complete.

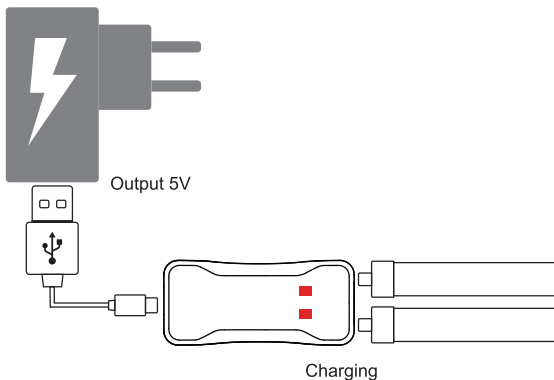

Two batteries can be charged at the same time. Charging a fully discharged battery takes approximately 20 minutes. When the battery is inserted into the TEST port and the charger is not plugged in via USB cable, the current battery level will be displayed. 4.30 indicates a fully charged battery while 3.30 indicates the battery is low.

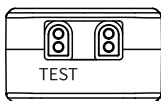

Full Power



Low Power

Note: The electric display charger in this kit cannot be charged with a double-head Type-C data cable.

4.Remote Control Radio Transmitter

The remote control radio transmitter included in this kit is the LiteRadio 2 SE model (Frsky Protocol). Instructions of its buttons are shown below:

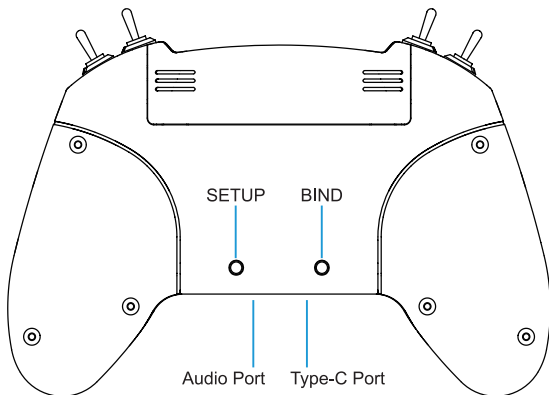
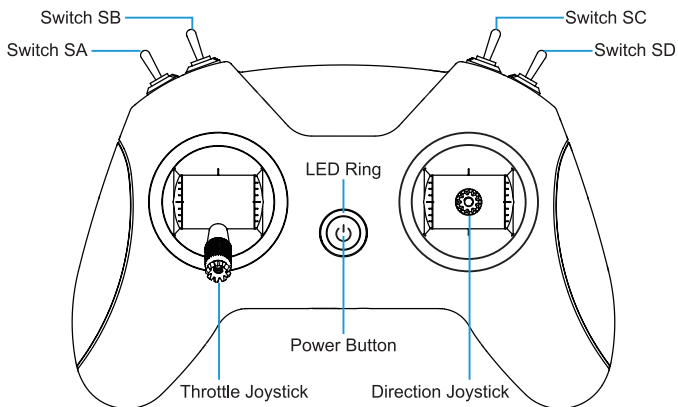

4.1 Switch Functions

Four switches are provided on the front of the remote control radio transmitter: switch SA, switch SB, switch SC, and switch SD, as shown below. Pilot can change different modes and parameters of the quadcopter with these switches. Please caution that only after the remote control radio transmitter and the quadcopter are connected successfully, the switches can work.

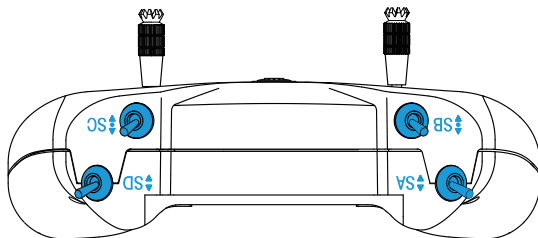

Switch SA: Arm/Disarm Quadcopter

- Quadcopter will be disarmed if switch SA is down.
- Quadcopter will be armed if switch SA is up.

Switch SB: Flight Mode of Quadcopter

- The flight mode is “Normal Mode” if switch SB is down (N MODE).
- The flight mode is “Sport Mode” if switch SB is in the middle (S MODE).
- The flight mode is “Manual Mode” if switch SB is up (M MODE).

Switch SC: Speed Threshold of Quadcopter

- It is low gear if switch SC is down (SLOW).
- It is middle gear if switch SC is in the middle (MID).
- It is high gear if switch SC is up (FAST).

Switch SD: Change Video Transmitter (VTX) frequency

Each time the switch SD is toggled, the quadcopter’s video transmitter (VTX) frequency will switch to the next one. 8 frequencies are available. After switching to the last frequency(5866), frequency will cycle to the first one(5733) and start again.

The factory default frequencies are 5733/5752/5771/5790/5809/5828/5847/5866 in sequence.

Switch SD (Quadcopter in Flip State): Turtle Mode of Quadcopter

- Turtle Mode is on when Switch SD is toggled from down to up.
- Turtle Mode is off when Switch SD is down after the quadcopter is reverse back to the normal position.

4.2 Joystick Functions

Two joysticks (throttle & direction joysticks) on the front of the remote control radio transmitter control the quadcopter: Ascent/descent (throttle), forward/backward tilt (pitch), left/right tilt (roll), and rotation of flight direction(yaw) .

Throttle (left) Joystick - Ascent/descent (throttle) and rotation of flight direction (yaw).

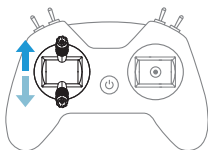

Joystick up/down

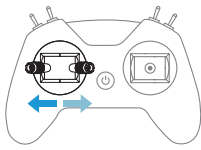
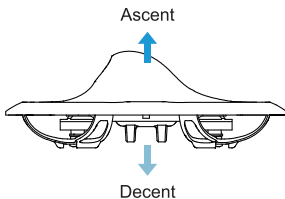

Joystick left/right

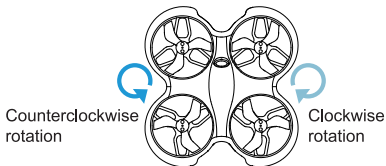

Direction (right) Joystick - Forward/backward tilt (pitch) and left/right tilt (roll).

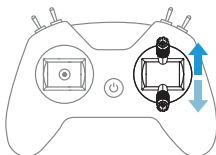

Joystick up/down

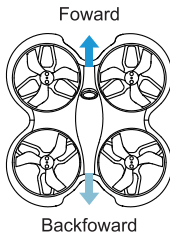

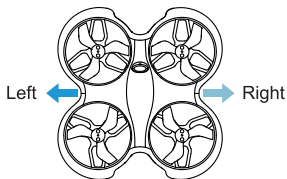
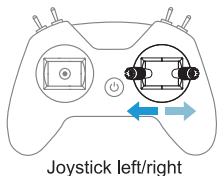

4.3 Button Functions

There are three buttons on the remote control radio transmitter.

- Power button: Turns the remote control radio transmitter on/off with a long press.
- BIND button: Enter binding mode with a short press (active after the remote control radio transmitter is powered on).
- SETUP button: Enter joystick calibration mode with a short press after the remote control radio transmitter is powered on.

Refer “Advanced Settings” for more information on binding or joystick calibration.

4.4 Charging the Remote Control Radio Transmitter

The remote control radio transmitter has a built-in 1000mAh battery. If the blue light flashes slowly, it indicates that the battery is low and needs to be recharged. To charge the remote control radio transmitter battery:

- Turn off the remote control radio transmitter;
- Connect remote control radio transmitter and adapter with the Type-C cable. (5V output adapter is allowed, such as mobile phone charger);
- A red LED indicates charging, while off means fully charged.

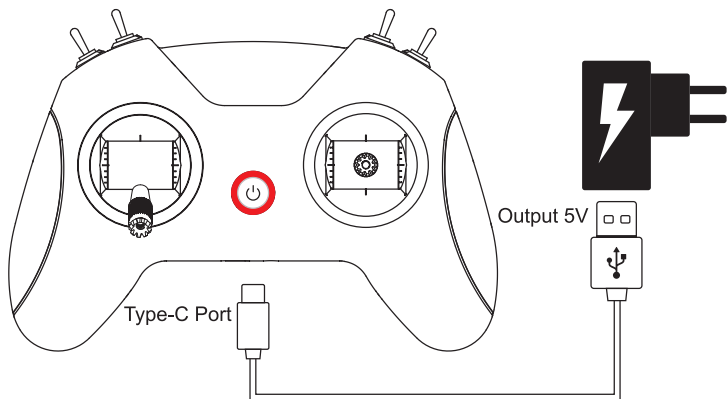

Note: The remote control radio transmitter in this kit cannot be charged with a double-head Type-C data cable.

5.FPV Goggles

The FPV goggles used in the kit named model VR02. The FPV goggles use the built-in antenna to receive video.

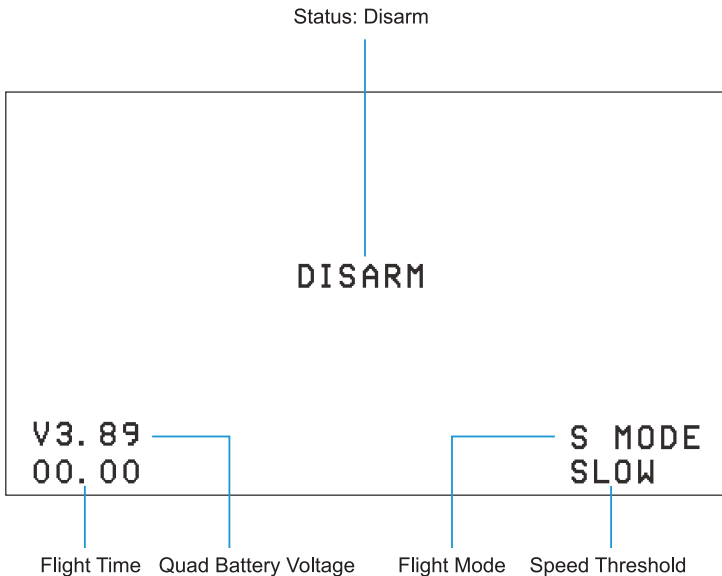

5.1 Button Operation

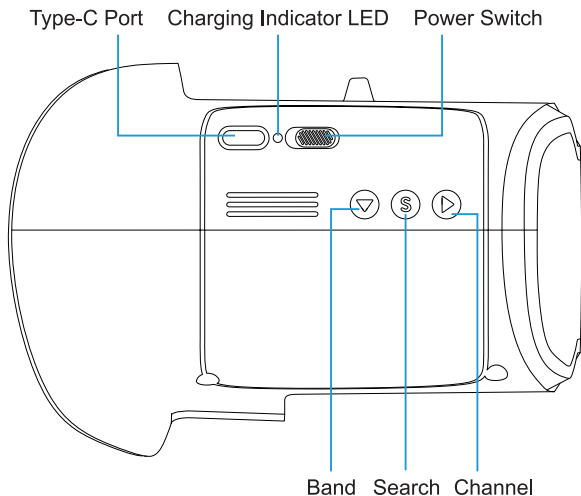

- Power switch

Turn the power switch left and right to turn the goggles on or off. When facing the switch, the left position is off; the opposite of the position is on.

- Search button (S)

Quick frequency search: Press and hold the frequency search button for 1 second to start the frequency search. After 3 seconds, a beep will sound and the best available frequency will be selected. Quick frequency search is completed.

Frequency scan: Short press the frequency search key once to enter the frequency scan interface.

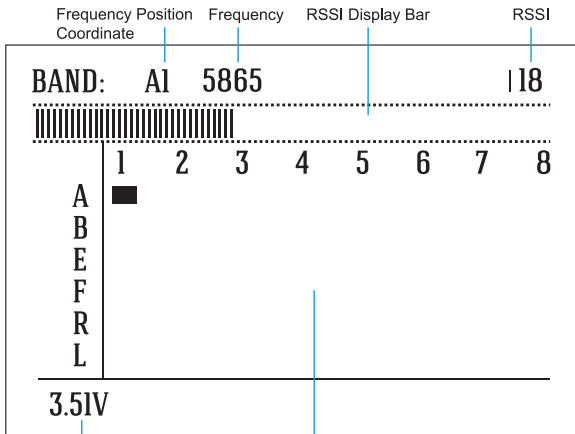

Goggles Voltage

Frequency Scanning Results Table

Press and hold for 1 second to start the frequency scan, and the frequency scan result will be displayed after 3 seconds. The different colors in the screen indicate the current status of each frequency as follows:

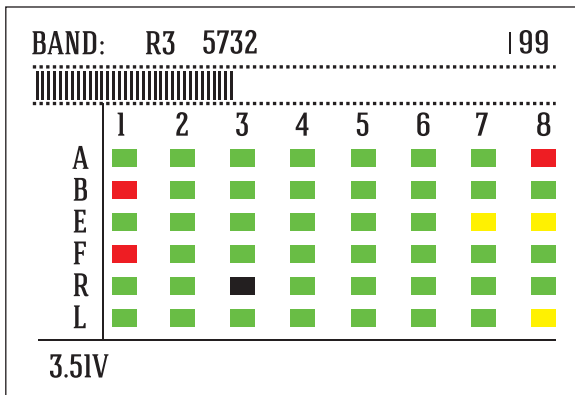

Green	0<RSSI<20 Frequency is available
Yellow	20<RSSI<70 Frequency has moderate interference from another transmitter
Red	70<RSSI<99 Frequency is completely in use by a transmitter
White	The strongest signal which the goggles received in this scan

- Band Key and Channel Key

In the frequency scan interface, the Band Key can be cycled down to select different bands, and the Channel Key can be cycled to the right to select different channels.

Pilot can select the goggles frequency by pressing the Band Key and Channel Key.

For example, select a band and channel with green status since these frequencies are not occupied and signal interference is relatively weak. Then, set the quadcopter to the corresponding frequency and adjust the goggles to match.

5.2 Frequency Selection

The FPV goggles can receive 48 frequency points in the 5.8GHz spectrum, distributed across 6 bands (A, B, E, F, R, and L) of 8 channels (CH-1,, CH-8), as shown below:

The stock quadcopter included in this kit only uses 8 frequency points of band B, which is the second row in the table below:

	CH 1 (MHZ)	CH 2 (MHZ)	CH 3 (MHZ)	CH 4 (MHZ)	CH 5 (MHZ)	CH 6 (MHZ)	CH 7 (MHZ)	CH 8 (MHZ)
A	5865	5845	5825	5805	5785	5765	5745	5725
B	5733	5752	5771	5790	5809	5828	5847	5866
E	5705	5685	5665	5645	5885	5905	5925	5945
F	5740	5760	5780	5800	5820	5840	5860	5880
R	5658	5695	5732	5769	5806	5843	5880	5917
L	5362	5399	5436	5473	5510	5547	5584	5621

Press and hold the Search Key for 1 second to automatically search for the frequency point with the strongest signal strength in the space to obtain the FPV picture of the quadcopter.

We can also shortly press the Band Key to switch to the designated band and use the Chanel Key to switch to the designated channel so that the FPV goggles can work on the designated frequency point.

5.3 Charging the FPV Goggles

The FPV goggles have a built-in 2000mAh battery and no external battery is required. When voltage is below 3.55V, a beep will sound in every 10s and it needs to be recharged. We can also press the S button to check the voltage. To charge the goggles battery:

- Turn off the FPV goggles;
- Connect FPV goggles and adapter with the Type-C cable (5V output adapter is allowed, such as mobile phone charger);
- The power light will be blue when charging and lights out when fully charged.

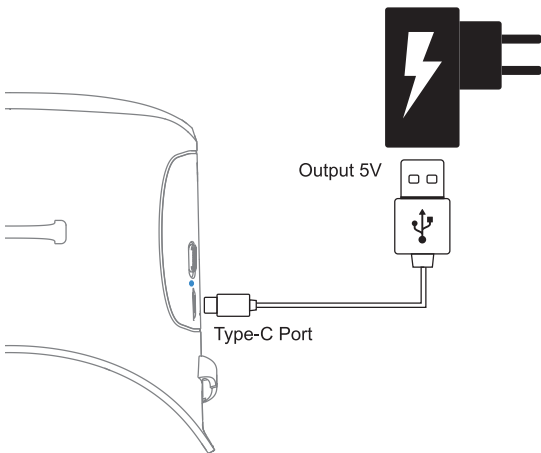

Note: The FPV goggles in this kit cannot be charged with a double-head Type-C data cable.

6. Quadcopter OSD Menu Operation

The OSD menu is a set of operation interfaces designed to modify the configuration of the quadcopter.

- Turn on/off quadcopter RGB LED lights;
- Turn on/off sensor;
- Add/Remove information from the flight OSD.

6.1 How to Access/Operate OSD Setting Menu

The position of joysticks to access the OSD setting menu is as shown below. The throttle joystick is moved to the left-center and the direction joystick towards the upward center.

Caution: Make sure the quadcopter is disarmed before accessing the OSD menu.

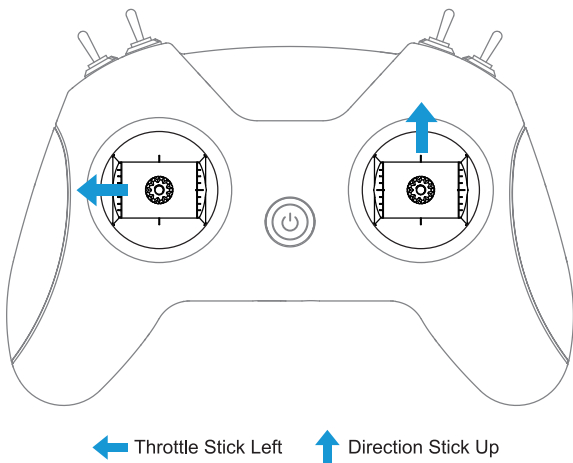

After accessing the OSD menu, pilot will see the following menu interface on the FPV screen.

```
- MAIN -  
>CONFIG      >  
  LAYOUT    >  
  
  SAVE  
  EXIT
```

The OSD menu cursor can be controlled by the right joystick to operate the OSD interface:

- Up: move the cursor up
- Down: move the cursor down
- Right: confirm/modify selection

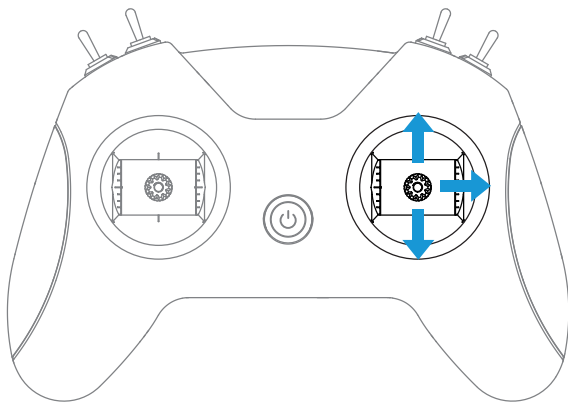

↑ Joystick up:
Cursor Move up

↓ Joystick down:
Cursor Move down

→ Joystick right:
Modification/Confirmation

6.2 Turn Quadcopter RGB LED ON/OFF

The quadcopter status LED light is normally solid blue when flying. This can be changed to color cycling:

- In the MAIN menu, select CONFIG and enter the CONFIG menu, as shown below;
- Select LED, select OFF (for solid blue) or ON (for RGB color cycling effect);
- Select BACK to exit CONFIG sub-menu;
- Select SAVE in the MAIN menu to save changes and exit the OSD.

- CONFIG -

TOF	OFF
OPF	ON
>LED	OFF
CALI	OK

BACK

6.3 Customizing OSD Flight Information

The information displayed in the OSD flight interface can be customized. This information includes : receiver protocol, flight mode, battery voltage and speed threshold.

- In the MAIN menu, select LAYOUT and enter the LAYOUT menu, as shown below;
- Select the target information item, OFF means no display, ON means display;
- Select SAVE in the MAIN menu to save the settings and exit the OSD.

- LAYOUT -

>VOL	ON
MODE	ON
TIME	ON
SPEED	ON

BACK

7.LED Light/Beep Status Codes

7.1 Quadcopter LED Light

There are two RGB status LEDs on the bottom of the quadcopter.

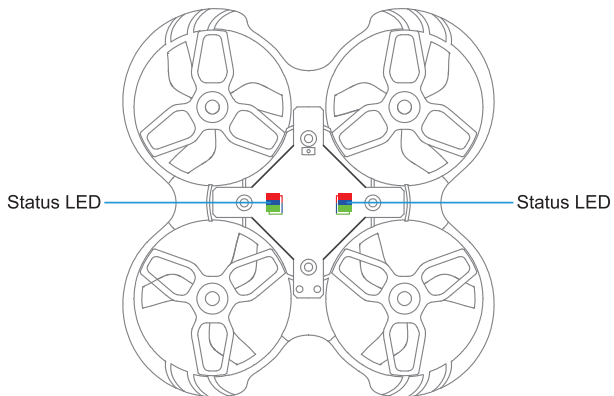

Status LED color	Status	State description	Solution
—	Off	The power on the quadcopter is abnormal or off	Replace the battery and power on again
Red	Flashing slowly	Quadcopter battery is low	Replace the battery
Blue	Solid	The quadcopter is connected with the remote control radio transmitter	
Blue	Flashing fast	Quadcopter is horizontal calibrating	Place the quadcopter on a horizontal surface and wait for a while
Purple	Solid	Quadcopter accessed the OSD menu	
Green	Flashing fast	Quadcopter is in binding mode	
White	Flashing fast	Arming failed, because the throttle joystick was not at the lowest position when arming	Disarm, and place the throttle joystick at the lowest position
Brown	Flashing slowly	Loss of remote control radio transmitter signal	Re-establish the connection with the remote control radio transmitter

7.2 Remote Control Radio Transmitter LED Light & Beep Status Codes

There is a blue&red LED indicator light around the power button which indicates the status of the remote control radio transmitter.

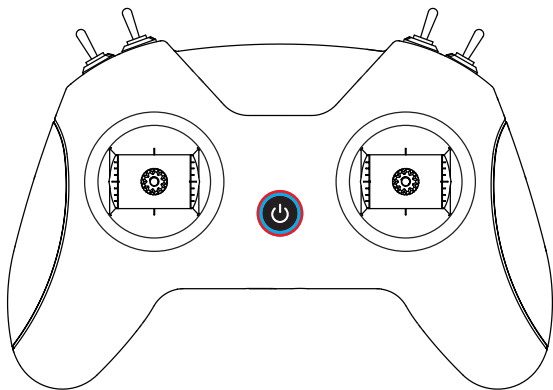

Indicator LED color	Status	State description	Solution
Red	Solid	Throttle joystick is not at the lowest position when starting	Move throttle joystick to the lowest position
Red	Flashing fast	Remote control radio transmitter is in binding mode	Wait for binding
Blue	Flashing slowly	Battery voltage is too low	Charge remote control radio transmitter

There is a built-in beeper, pilot can recognize the working status of the remote control radio transmitter by its sound.

Beep	State description
Three consecutive beeps: beep-beep-beep	Low battery

7.3 FPV Goggles LED Light Status Codes

The FPV Goggles have a LED indicator lights which indicate battery power.

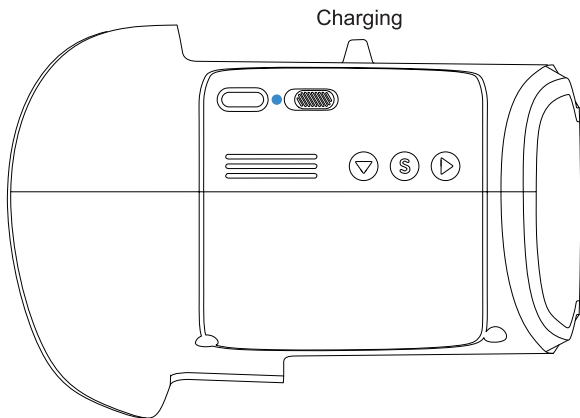

Indicator LED color	Status	State description
Blue	Solid	Charging
—	Off	Not charging or charging is complete

8. Advanced Settings

Additional advanced settings are available in case of special operations.

8.1 Turtle Mode

When the quadcopter falls to the ground and is facing down, we can activate turtle mode with the remote control radio transmitter to turn it over. To activate turtle mode:

- Toggle switch SD from down to up to activate turtle mode. TURTLE is displayed in the OSD, as shown below;
- Move the direction joystick towards either direction. The motor will spin, and the quadcopter will reverse;
- Move switch SD down to turn off turtle mode;
- Arm the quadcopter and operate normally.

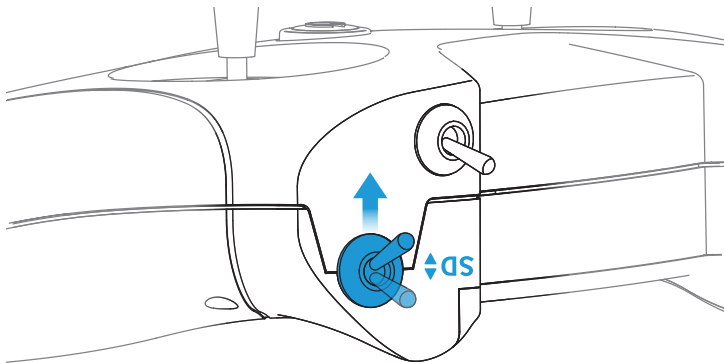

Quadcopter in Flip State: Toggle Switch SD
from Down to Up to Activate Turtle Mode

Note: Turtle mode is suitable for flat ground and it's not recommended to activate this mode on grass or fabrics as the motor may be obstructed, resulting in damage of the motors and ESC.

8.2 Re-Bind for Quadcopter

If quadcopter and remote control radio transmitter cannot be connected successfully, the pilot may need to re-bind. This can happen when replacing new electronic parts of the quadcopter during maintenance or upgrading the remote control radio transmitter. The steps are as follows:

- Power on the quadcopter and wait for its system to load completely;
- Use a screwdriver to lightly press the button on the quadcopter and the status light on the quadcopter turns green and starts to flash;
- Power on the remote control radio transmitter and wait for its system to load completely;
- Lightly press the BIND button on the back of the remote control radio transmitter with a screwdriver. The power indicator will flash red;
- If re-bind is successful, quadcopter status light will change to blue.

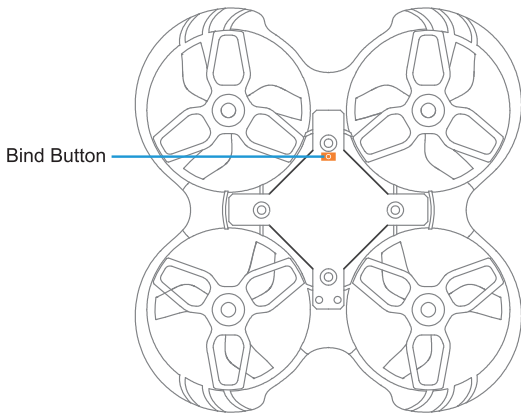

Note: The re-binding of the remote control radio transmitter and the quadcopter may not be successful after pressing the BIND button of the remote control radio transmitter once. In this situation, pilot needs to press the BIND button a second time to complete the binding.

8.3 Quadcopter Level Calibration

After the quadcopter has taken off and landed several times, the quadcopter gyroscope may become offset. This will cause the quadcopter to always tilt in the same direction during a flight. To fix up it, the quadcopter gyroscope can be recalibrated. The steps are as follows:

- Turn on the quadcopter and the remote control radio transmitter, and ensure that the connection is successful;
- Place the quadcopter on a horizontal plane;
- Enter the quadcopter's OSD menu (Refer "OSD Menu Operation");
- In the MAIN menu, select CONFIG, then CALI;
- Push the direction joystick to the right to enter level calibration mode. Quadcopter's LED flashes blue;
- When the OK prompt appears and the LED returns to solid blue, the calibration is complete. Pilot can exit the OSD menu.

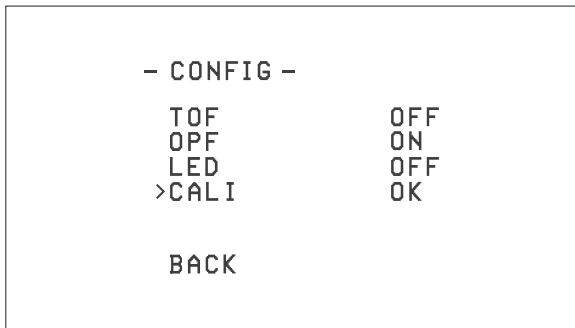

Note: For more information about how to access and operate OSD menu, please refer to the Chapter "OSD Menu Operation".

8.4 Remote Control Radio Transmitter Calibration

After repeated use or if the remote control radio transmitter is subjected to physical impact, the joysticks may no longer read correctly and require recalibration.

- After powering on, press the SETUP button on the back of the remote control radio transmitter which will beep twice, and LED will flash red twice quickly. The remote control radio transmitter has entered calibration mode.
- Move throttle joystick and direction joystick to middle position. Press SETUP button again and wait until the remote control radio transmitter beeps three times. The red LED will flash twice quickly. This indicates joysticks center data has been acquired.
- Slowly rotate the throttle and direction joystick twice around the boundary of the joysticks(once counterclockwise and once clockwise), then press SETUP button again. The remote control radio transmitter will emit a beep for about 3 seconds and LED will stop flashing. Calibration has been completed successfully.

8.5 Turn OFF/ON the Optical Flow Positioning Function

In Normal Mode, the optical flow positioning function of Cetus Pro quadcopter is turned on by default, which provides an auxiliary function for horizontal flight. It will bring a better flying experience in an environment with more obvious ground features and sufficient light.

The steps to turn off/on the optical flow positioning function are as follows:

- Operate the remote control radio transmitter to access the OSD setting menu;
- In the MAIN menu, select CONFIG and access the CONFIG menu, as shown below;
- Select OPF and change it to OFF (turn off positioning)/ON (turn on positioning), and then select BACK to exit the CONFIG sub-menu;
- Select SAVE in the MAIN menu to exit the OSD setting interface.

- CONFIG -

TOF	OFF
>OPF	ON
LED	OFF
CALI	OK

BACK

8.6 Turn OFF/ON Laser Altitude Determination

• In Normal Mode, the laser altitude determination function is turned off by default. Turning on this function can make the hovering of the quadcopter more accurate and the quadcopter can maintain a fixed relative height with ground objects to achieve autonomous obstacle avoidance and lifting. The steps to turn off/on the laser altitude determination are as follows:

- Operate the remote control radio transmitter to access the OSD setting menu;
- In the MAIN menu, select CONFIG and access the CONFIG menu, as shown below;
- Select TOF and change it to OFF (turn off function)/ON (turn on function), and then select BACK to exit the CONFIG sub-menu;
- Select SAVE in the MAIN menu to exit the OSD setting interface.

- CONFIG -

>TOF	OFF
OPF	ON
LED	OFF
CALI	OK

BACK

9. Supplement

9.1 Warning & Security

- Move the throttle joystick as gently as possible to avoid the quadcopter ascending and descending too suddenly.
- Push switch SA down on the remote control radio transmitter immediately if the quadcopter collides with any object.
- Please try to keep motors perpendicular to the body. Otherwise, flight performance will be degraded.
- Learn to control the quadcopter proficiently before flying in a large outdoor area or with the wind.
- Battery life can be significantly reduced if pilot continues to fly after the low voltage warning is shown.
- Do not fly in rain. Humidity may cause unstable flight or loss of control.
- Keep the battery away from water. If the flight controller touches water, a short circuit may occur and the flight controller may burn out.
- Do not fly in inclement weather with thunderstorms or lightning.
- Do not fly in areas that are not permitted by local law.

9.2 Precautions for Battery Use and Charging

- Do not immerse the battery in water. Store in a dry area if not used for a long time.
- Keep away from children. If swallowed, seek medical attention immediately.
- Do not use or store the battery near heat sources, microwave ovens, or open flame.
- Only use a battery charger that meets the specifications when charging.
- Do not throw the battery into fire or heat the battery.
- Do not use or store the battery in an extremely hot environment, such as in a car under direct sunlight or hot weather. Overheating affects the performance of the battery and shortens the service life of the battery. Overheated batteries can catch fire.
- If the battery has a peculiar smell, temperature, deformation, discoloration, or any other abnormal phenomenon, stop using the battery. Recycle and replace the battery.
- If the battery connector gets dirty, please wipe it with a dry cloth before use. Avoid getting battery contacts dirty, which can cause energy loss or failure to charge.
- Disposing of the battery randomly may cause a fire. Please fully discharge the battery and use insulating tape to dispose of the battery output connector before disposing of

the battery. Refer to local regulations before disposing or recycling a battery.

9.3 After-Sale Service

- **Warranty:** All defective merchandise, unless otherwise indicated, may be returned for a replacement within 30 days from the goods received date. We cannot provide refunds or replacements beyond 30 days.
- If the product is confirmed to have a quality problem (product design or quality issues), we will cover it with replacing or refund.
- All warranty replacements are required to have photos or videos and a detailed description. Warranty does not cover physically damaged merchandise. We are willing to figure out the best solutions, as always.
- For after-sale service, please reach out via e-mail: Support@betafpv.com

This clause only applies to the products manufactured by BETAFPV and sold by BETAFPV authorized dealers.

The specific interpretation rights of this clause belong to BETAFPV.

10.FAQ

10.1 How to Replace Propellers

Propellers can be deformed or fall off when quadcopter collides with an object. Bent or missing propellers need to be replaced.

Use the included propeller removal tool to remove propellers from the motor. Please hold the motor instead of the frame duct with your hand when removing propellers to protect the frame from being deformed by overexertion.

4 spare propellers are included: two each clockwise (CW) and counterclockwise (CCW). CW propeller warps clockwise. It is used on the rear left or front right motor. CCW propeller warps counterclockwise. It is used on the rear right or front left motor. Install as in the diagram below.

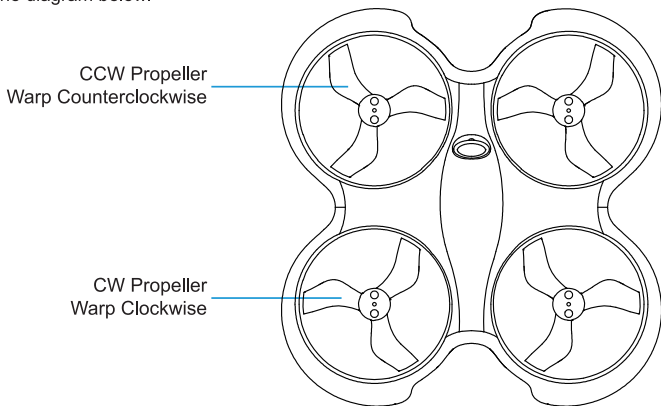

10.2 How to Adjust When the Quadcopter Drifts or When It's Difficult to Control in Normal Mode

In Normal Mode, the optical flow positioning function of Cetus Pro quadcopter is turned on by default. Try to avoid an unsatisfactory environment of which ground features are difficult to identify. Otherwise, the quadcopter may drift or become difficult to control. The following are common unsatisfactory environments:

- Dark environment;
- Above the water surface;
- Above smooth tiles or single-color smooth ground.

If the quadcopter needs to fly in an unsatisfactory environment, the optical flow positioning function can be turned off and the quadcopter will lose the auxiliary function of horizontal flight. This requires pilot's better skills.

Similarly, when the laser altitude determination function is turned on, try to avoid the following unsatisfactory environments:

- An environment with strong sunlight or with obvious light and dark changes;
- Pure black ground;
- Strongly reflective ground, etc.

For the steps to turn off/on the positioning function or laser altitude determination function, please refer to the chapter of "Advanced Functions".

Please make sure that the bottom of the sensor is not blocked by foreign objects, and the surface of the sensor is free of dirt and dust that will affect its accuracy. When the flight auxiliary function is abnormal, the sensor should be wiped clean before continuing to use.

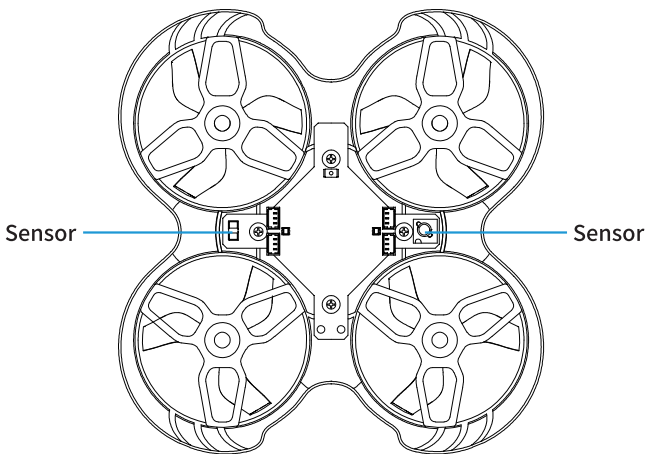

10.3 How to Use FPV Simulator

The safest and quickest method to get started is to use an FPV simulator. The Lite Radio 2 SE remote control radio transmitter supports most FPV simulators on the market with a comprehensive configuration.

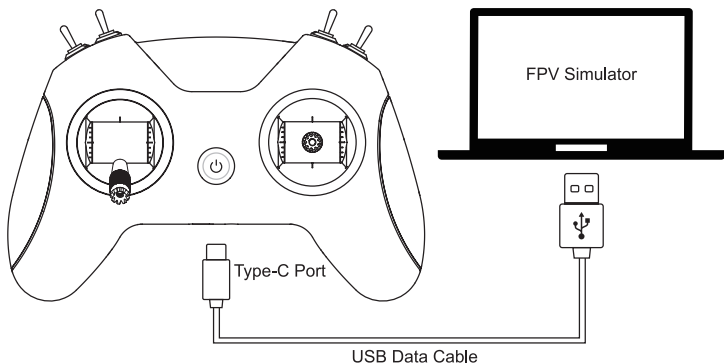

To connect your radio:

- Turn on the remote control radio transmitter and wait the blue light to show;
- Connect the remote control radio transmitter with PC by USB cable;
- The correct driver will install automatically. A box pops up to confirm successful installation.

⚙️ Setting up a device

We're setting up 'BETAFPV JoyStick'.



Bluetooth & other devices

Other devices



BETAFPV JoyStick

10.4 How to Stop After A Collision

- Push down switch SA on the remote control radio transmitter immediately once the quadcopter collides with an object. All motors will immediately stop.
- In Normal Mode, if the flying altitude is too high and it is difficult to control, please push down switch SA immediately to stop the motor.

Caution: Push down switch SA immediately when the quadcopter is hit or the propellers scratch against the frame duct.

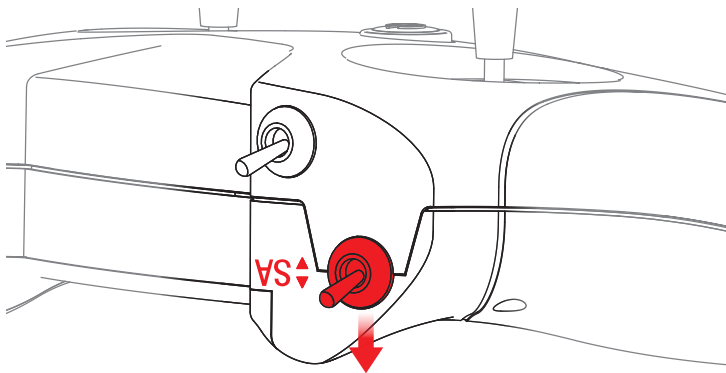

Push Down to Disarm the Quadcopter



betafpv.com