

AGRAS T20

User Manual

v1.4

2020.12

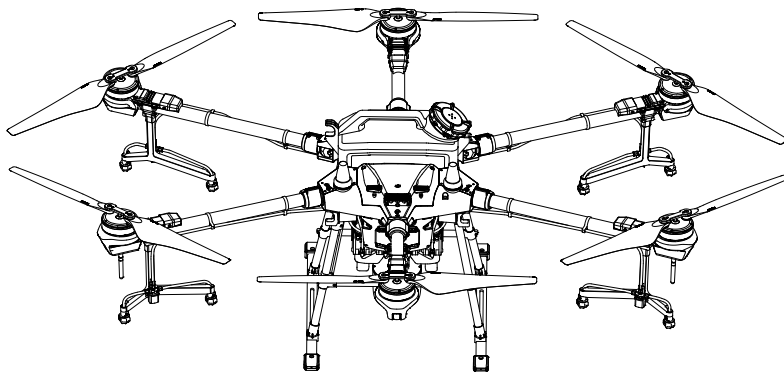

Searching for Keywords

Search for keywords such as “battery” and “install” to find a topic. If you are using Adobe Acrobat Reader to read this document, press Ctrl+F on Windows or Command+F on Mac to begin a search.

Navigating to a Topic

View a complete list of topics in the table of contents. Click on a topic to navigate to that section.

Printing this Document

This document supports high resolution printing.

Information

1. The AGRAS™ T20 does not come with a flight battery. Only purchase official DJI™ flight batteries (model: AB3-18000mAh-51.8V). Read the T20 Intelligent Flight Battery User Guide and take necessary precautions when handling the batteries to ensure your own safety. DJI assumes no liability for damage or injury incurred directly or indirectly from misusing batteries.
2. In this document, the altitude limit of 30 m means the altitude between the aircraft and the surface of the objects below it when the altitude stabilization function of the radar module is enabled. If the function is disabled, the altitude limit means the altitude between the aircraft and the takeoff point.

Using This Manual

Legend

 Important

 Hints and tips

 Reference

Before Flight

The following documents have been produced to help you safely operate and make full use of your aircraft:

1. In the Box
2. Disclaimer and Safety Guidelines
3. Quick Start Guide
4. User Manual

Refer to the Agras T20 In the Box to check the listed parts and read the disclaimer and safety guidelines before flight. Refer to the quick start guide for more information on assembly and basic operation. Refer to the user manual for more comprehensive information.

Downloading DJI Assistant 2 for MG

Download DJI ASSISTANT™ 2 for MG from:

<https://www.dji.com/t20/downloads>

 The operating temperature of this product is 0° to 40° C (32° to 104° F). It does not meet the standard operating temperature for military grade application (-55° to 125° C (-67° to 257° F)), which is required to endure greater environmental variability. Operate the product appropriately and only for applications that it meets the operating temperature range requirements of that grade.

Safety at a Glance

1. Pesticide Usage

- Avoid the use of powder pesticides as much as possible as they may reduce the service life of the spraying system.
- Pesticides are poisonous and pose serious risks to safety. Only use them in strict accordance with their specifications.
- Residue on the equipment caused by splashes or spills when pouring and mixing the pesticide can irritate your skin. Make sure to clean the equipment after mixing.
- Use clean water to mix the pesticide and filter the mixed liquid before pouring into the spray tank to avoid blocking the strainer. Clear any blockage before using the equipment.
- Make sure to stay in an upwind area when spraying pesticide to avoid bodily harm.
- Wear protective clothing to prevent direct body contact with the pesticide. Rinse your hands and skin after handling pesticides. Clean the aircraft and remote controller after applying the pesticide.
- Effective use of pesticides depends on pesticide density, spray rate, spray distance, aircraft speed, wind speed, wind direction, temperature, and humidity. Consider all factors when using pesticides, but DO NOT compromise the safety of people, animals, or the environment in doing so.
- DO NOT contaminate rivers and sources of drinking water.



The Agras T20 aircraft is not a toy and is not suitable for children under the age of 18.

Note that the Safety at a Glance section only provides a quick overview of the safety tips. Make sure you read and understand this document and the Agras T20 User Manual.

2. Environmental Considerations

- Fly at locations that are clear of buildings and other obstacles. DO NOT fly above or near large crowds.
- The recommended maximum operating altitude is 2 km (6,560 ft) above sea level. DO NOT fly over 3 km (9,842 ft) above sea level.
- Only fly in moderate weather conditions with temperatures between 0° and 40° C (32° and 104° F).
- Make sure that your operations do not violate any applicable laws or regulations, and that you have obtained all appropriate prior authorizations. Consult the relevant government agency or authority, or your lawyer before flight to ensure you comply with all relevant laws and regulations.
- DO NOT operate any part of the aircraft indoors.

3. Pre-Flight Checklist

Make sure to check all of the following:

- Remote controller and aircraft batteries are fully charged.
- All parts are in good condition. Replace aged or broken parts before flight.
- Landing gear and spray tank are firmly in place.
- Propellers and frame arms are unfolded and arm sleeves are firmly tightened. Propellers are in good condition and firmly tightened. There is nothing obstructing the motors and propellers.
- Spraying system is not blocked and works properly.
- Compass is calibrated after being prompted to do so in the app.

4. Ingress Protection Rating Description

The T20 is waterproof, dustproof, and corrosion-resistant when it is functioning normally. Under stable laboratory conditions, the aircraft has a protection rating of IP56 (IEC standard 60529)

and can be cleaned using a small amount of water. The aeriëlelectronics system (barometer excluded), spray control system, ESC system, and radar module has a protection rating of up to IP67. However, this protection rating is not permanent and may reduce over time after long-term use due to aging and wear. The product warranty does not cover water damage. The protection ratings of the aircraft mentioned above may decrease in the following scenarios:

- There is a collision and the seal structure is deformed.
- The seal structure of the shell is cracked or damaged.
- The waterproof covers are not properly secured.

5. Operation

- Stay away from the rotating propellers and motors.
- The takeoff weight must not exceed 45.5 kg when using near sea level. Note that when using at a higher sea level, the takeoff weight capacity will be reduced.
- Once the operating altitude reaches 1 km (3,280 ft), the payload capacity of the spray tank is reduced by 2 kg. For every additional km, the payload capacity will be reduced another 2 kg.
- Maintain a visual line of sight (VLOS) of your aircraft at all times.
- DO NOT use the Combination Stick Command (CSC) or other methods to stop the motors when the aircraft is airborne unless in an emergency situation.
- DO NOT answer incoming calls during flight. DO NOT fly under the influence of alcohol or drugs.
- If there is a low battery warning, land the aircraft at a safe location.
- If the radar module is unable to work properly in the operating environment, the aircraft will be unable to avoid obstacles during Return to Home (RTH). All that can be adjusted is the flight speed and altitude, as long as the remote controller is still connected.
- After landing, stop the motors, power off the aircraft, and power off the remote controller. Otherwise, the aircraft may enter Failsafe RTH automatically due to remote controller signal loss.
- Maintain full control of the aircraft at all times and do not rely on the DJI Agras app. The obstacle avoidance function is disabled in certain situations. Keep the aircraft within VLOS and pay close attention to its flight. Use your discretion to operate the aircraft and manually avoid obstacles in a timely manner. It is important to set an appropriate Failsafe and RTH altitude before each flight.

6. Maintenance and Upkeep

- DO NOT use aged, chipped, or broken propellers.
- To avoid damaging the landing gear, remove or empty the spray tank during transportation or when not in use.
- Recommended storage temperature (when the spray tank, flow meter, pumps, and hoses are empty): -20° to 40° C (-4° to 104° F).
- Clean the aircraft immediately after spraying. Inspect the aircraft regularly. Refer to Product Care in the Agras T20 Disclaimer and Safety Guidelines for more information about maintenance guidelines.

7. Observe Local Laws and Regulations

- You can find a list of DJI GEO zones at <http://www.dji.com/flysafe>. Note that the DJI GEO zones are not a replacement for local government regulations or good judgment.
- Avoid flying at altitudes above 30 m (98 ft).*

* In this document, the altitude limit of 30 m means the altitude between the aircraft and the surface of the objects below it when the altitude stabilization function of the radar module is enabled. If the function is disabled, the altitude limit means the altitude between the aircraft and the takeoff point.

The flying altitude limit varies in different countries or regions. Make sure to fly at the altitudes outlined by local laws and regulations.



Fly in Open Areas

+

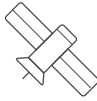

Strong GNSS Signal

+



VLOS

+



Fly Below 30 m (98 ft)

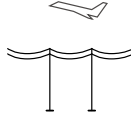

Avoid flying over or near crowds, high voltage power lines, or bodies of water. Strong electromagnetic sources such as power lines, base stations, and tall buildings may affect the onboard compass.



DO NOT use the aircraft in adverse weather conditions such as winds exceeding 28 kph (17 mph), heavy rain (precipitation rate exceeding 25 mm (0.98 in) in 12 hours), fog, snow, lightning, tornadoes, or hurricanes.

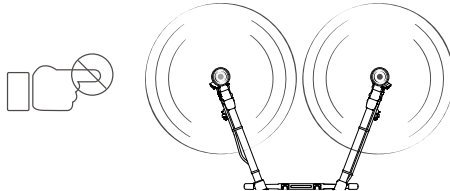

Stay away from the rotating propellers and motors.



GEO Zones

Learn more at: <http://www.dji.com/flysafe>

Contents

Information	1
Using This Manual	1
Legend	1
Before Flight	1
Downloading DJI Assistant 2 for MG	1
Safety at a Glance	2
Contents	5
Product Profile	7
Introduction	7
Feature Highlights	7
Preparing the Aircraft	8
Preparing the Remote Controller	9
Aircraft Overview	11
Remote Controller Overview	12
Aircraft	14
Aircraft Profile	14
Flight Modes	14
Operation Modes	14
Operation Resumption	21
System Data Protection	23
Omnidirectional Digital Radar	23
Empty Tank	26
Return to Home (RTH)	26
Low Battery and Low Voltage Warnings	28
RTK Functions	28
Aircraft LEDs	29
Remote Controller	30
Profile	30
Using the Remote Controller	30

Remote Controller LEDs	37
Remote Controller Warning Sounds	38
Linking the Remote Controller	38
DJI Agras App	39
Home Screen	39
Operation View	40
Flight	44
Operation Environment	44
Flight Limits and GEO Zones	44
Pre-Flight Checklist	46
Calibrating the Spraying System	46
Discharging the Bubbles in the Hoses	47
Calibrating the Compass	47
Starting and Stopping the Motors	49
Flight Test	50
DJI Assistant 2 for MG	51
Installation and Launching	51
Using DJI Assistant 2 for MG	51
Appendix	52
Specifications	52
Aircraft Status Indicators Description	56
Updating the Firmware	56

Product Profile

Introduction

The Agras T20 features a brand-new design including a foldable frame and a quick-release spray tank and flight battery, making replacement, installation, and storage easy. The stable and reliable modular aerial-electronics system is integrated with a dedicated industrial flight controller, OCUSYNC™ 2.0 HD transmission system, and RTK module. It has dual IMUs and barometers and adopts a propulsion control system redundancy design including both digital and analog signals to ensure flight safety.

The GNSS+RTK dual-redundancy system is compatible with GPS, GLONASS, BeiDou, and Galileo. The T20 also supports centimeter-level positioning^[1] when used with the onboard D-RTK™. Dual-antenna technology provides strong resistance against magnetic interference.

The upgraded spraying system features an improvement in payload. It also has a 4-channel electromagnetic flow meter to ensure consistent spraying for all sprinklers.

The new-generation omnidirectional digital radar provides functions such as terrain following and obstacle sensing and circumventing in all horizontal directions. The aircraft is equipped with a wide-angle FPV camera that enables users to observe the landscape from the front of the aircraft.

The Agras T20 JP version has a backup power system, which supplies power to the aircraft for approximately 20 seconds when the Intelligent Flight Battery is powered off due to malfunction during flight. This allows the aircraft to avoid accident and land safely.

Due to its industrial design and material, the T20 is dustproof, waterproof, and corrosion-resistant. The aircraft has a protection rating of IP56 (IEC standard 60529), while the protection rating of the aerial-electronics system, spray control system, propulsion ESC system, and radar module is up to IP67.

The Smart Controller 2.0 uses the DJI OcuSync 2.0 transmission system, has a maximum control distance of up to 3 km^[2], and supports Wi-Fi and Bluetooth functions. The remote controller is equipped with a 5.5-inch bright, dedicated screen that has the DJI Agras app built in, significantly improving smoothness and stability. When the RTK dongle is connected to the remote controller, users can plan operations to centimeter-level precision. The Multi-Aircraft Control mode of the remote controller can be used to coordinate the operation of up to five aircraft at the same time, enabling pilots to work efficiently. Both the built-in battery and external battery can be used to supply power to the remote controller. The total working time is up to 4 hours, which fully meets the requirements for long and high-intensity operations.

Feature Highlights

The modular design of the T20 simplifies assembly. The airframe can be quickly folded, making it easy for transportation. Both the Intelligent Flight Battery and spray tank are easily swappable, significantly improving the efficiency of power and liquid supply.

The T20 has an aerial-electronics system with a multiple redundancy design, and also has onboard D-RTK antennas, supporting dual-antenna technology that provides strong resistance against magnetic interference to ensure flight safety.

Thanks to the dedicated DJI industrial flight control system, the T20 offers four operation modes:

[1] The remote controller is able to reach its maximum transmission distance (FCC / NCC: 5 km (3.11 mi); CE / KCC / MIC / SRRC: 3 km (1.86 mi)) in an open area with no electromagnetic interference, and at an altitude of approximately 2.5 m (8.2 ft).
[2] The remote controller is able to reach its maximum transmission distance (FCC / NCC: 5 km (3.11 mi); CE / KCC / MIC / SRRC: 3 km (1.86 mi)) in an open area with no electromagnetic interference, and at an altitude of approximately 2.5 m (8.2 ft).

Route, A-B Route, Manual, and Manual Plus.

DJI Agras app automatically produces flight routes based on your planned fields. To start, simply select the field from the field list. Plan a field by walking with the remote controller, an RTK Dongle, an RTK handheld mapping device, or by flying the aircraft to waypoints, according to the application scenarios. In scenarios with complicated terrain, use the Phantom 4 RTK and DJI Terra to plan 3D flight routes, and import the routes to DJI Agras for operation.

In A-B Route operation mode, the aircraft travels along a planned route and sprays its liquid payload. Users can set the line spacing, flying speed, and other parameters.

In Manual operation mode, users can start and stop spraying manually and also adjust the spray rate.

In Manual Plus operation mode, the flight speed is restricted and the heading is locked. Except for the heading, users can control the movement of the aircraft via the control sticks. Press button C1 or C2 on the remote controller or the corresponding button in the app and the aircraft will fly one line spacing to the left or right. Note that button C1 and button C2 are customizable in the app.

The T20 also includes the Operation Resumption function. When pausing the operation in Route or A-B Route operation mode, Operation Resumption records a breakpoint for the aircraft. Users can resume from the breakpoint when continuing the operation.

The omnidirectional digital radar works automatically in Route, A-B Route, and Manual Plus operation modes during both day and night, without being affected by light or dust. Altitude detection and stabilization functions are available in forward, backward, and downward directions while Obstacle Avoidance is available in all horizontal directions. The radar module can detect the angle of a slope and automatically adjust to maintain the same distance with the surface even in mountainous terrain. In Route and A-B Route operation modes, the radar can effectively sense obstacles and plan a flight route to actively circumvent obstacles in all horizontal directions. Note that this is disabled by default. Users can enable it in the app.

The remote controller features Multi-Aircraft Control mode (coming soon), which can be used to coordinate the operation of up to five aircraft simultaneously. Turn the aircraft control switch dial on the remote controller to switch control between different aircraft.

Preparing the Aircraft

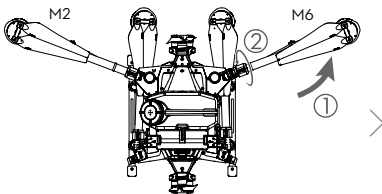

Unfold the M2 and M6 arms, and tighten the two arm sleeves.

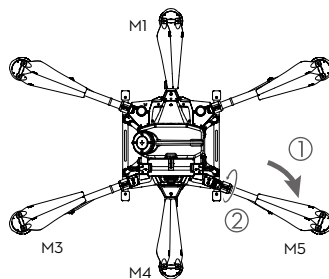

Unfold the M3 and M5 arms followed by M1 and M4, and then tighten the four arm sleeves.

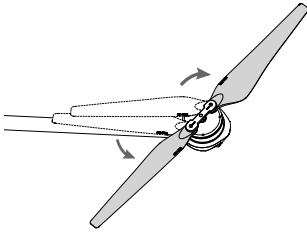

Unfold the propeller blades.

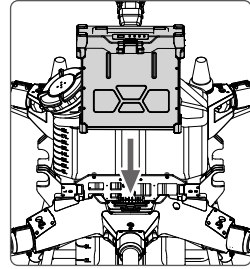

Insert the Intelligent Flight Battery into the aircraft until you hear a click.

- ⚠ • For the Agras T20 JP version, before using the aircraft, make sure to mount the backup battery. Otherwise, the aircraft cannot take off. Mount and use the backup battery in strict accordance with the Agras T20 Backup Battery User Guide.
- Make sure that the battery is firmly inserted into the aircraft. Only insert or remove the battery when the aircraft is powered off.
 - To remove the battery, press and hold the clamp, and then lift the battery up.
 - When folding the arms, make sure to fold the M3 and M5 arms first, and then the M2 and M6 arms. Otherwise, the arms may be damaged. Lift and lower the M1 and M4 arms gently to reduce wear and tear.

Preparing the Remote Controller

Mounting the External Battery

- ① Press and hold the battery release button.
- ② Insert the Intelligent Battery into the battery compartment. Make sure the bottom of the battery is aligned to the marking line in the compartment.
- ③ Push the battery to the bottom.

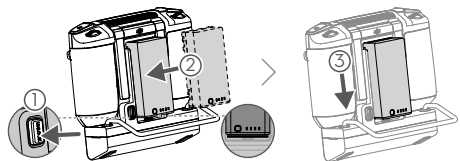

- ☀ To remove the Intelligent Battery, press and hold the battery release button, then push the battery upward.

Mounting the 4G Dongle and SIM Card

- ⚠️ • Only use a DJI-approved dongle. The dongle supports various network standards. Use a SIM card that is compatible with the chosen mobile network provider, and select a mobile data plan according to the planned level of usage.
- The dongle and SIM card enable the remote controller to access specific networks and platforms, such as the DJI AG platform. Make sure to employ them correctly. Otherwise, network access will not be available.

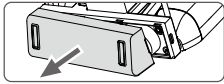

Remove the dongle compartment cover.

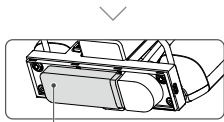

Insert the dongle into the USB port with the SIM card inserted into the dongle, and test the dongle.*

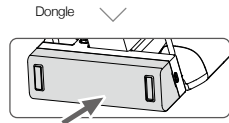

Reattach the cover firmly.

Mounting the RTK Dongle

When using the RTK planning method to plan the operation area, attach the RTK dongle to the USB-A port on the remote controller.

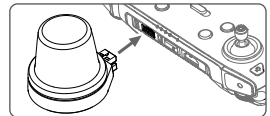

Adjusting the Antennas

Lift the antennas and adjust them. The strength of the remote controller signal is affected by the position of the antennas. When the angle between the antennas and the back of the remote controller is 80° or 180°, the connection between the remote controller and aircraft can reach its optimal performance.

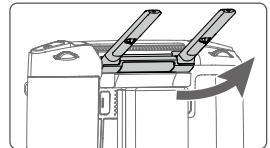

* Test procedure: Press the remote controller power button once, then press again and hold to power the remote controller on. In DJI Agras, tap , and select Network Diagnostics. The dongle and SIM card are functioning properly if the status of all the devices in the network chain are shown in green.

Aircraft Overview

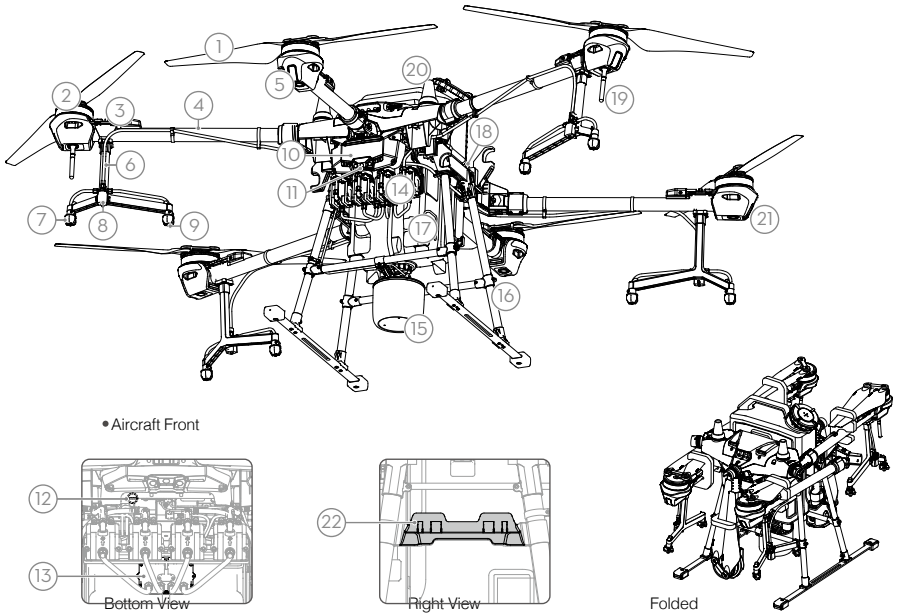

• Aircraft Front

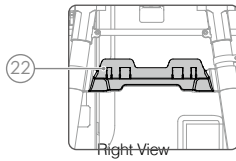
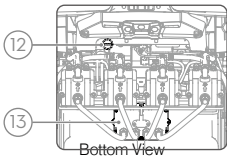

Folded

- | | |
|--|---|
| <ol style="list-style-type: none"> 1. Propellers 2. Motors 3. ESCs 4. Frame Arms 5. Aircraft Front Indicators (on the three front arms) 6. Hoses 7. Sprinklers 8. Electromagnetic Exhaust Valves 9. Nozzles 10. Aerial-Electronics System 11. FPV Camera 12. USB-C Port (on the bottom of the aerial-electronics system, under the waterproof cover) | <ol style="list-style-type: none"> 13. 4-Channel Electromagnetic Flow Meter 14. Delivery Pumps 15. Omnidirectional Digital Radar 16. Landing Gear 17. Spray Tank 18. Battery Compartment 19. OcuSync Antennas 20. Onboard D-RTK Antennas 21. Aircraft Status Indicators (on the three rear arms) 22. Remote Controller Holder |
|--|---|

Remote Controller Overview

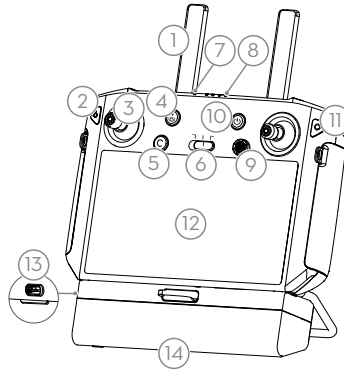

1. Antennas

Relays aircraft control and image transmission signal.

2. Back Button / Function Button

Press once to return to the previous page and press twice to go back to the homepage. Hold to view a guide to using button combinations. Refer to [Button Combinations \(p. 36\)](#) for more information.

3. Control Sticks

Controls aircraft movement. Control mode can be set in the app.

4. RTH Button

Press and hold this button to initiate RTH.

5. Button C3 (customizable)

6. Flight Mode Switch

The three positions are P-mode (Positioning), A-mode (Attitude), and P-mode (Positioning).

7. Status LED

Indicates whether the remote controller is linked to the aircraft.

8. Battery Level LEDs

Displays current battery level of the internal battery.

9. 5D Button (customizable)

10. Power Button

Used to power the remote controller on and off. When the remote controller is powered on, press the button to enter sleep mode or to wake up the controller.

11. Confirm Button

Press to confirm a selection.

12. Touch Screen

Tap to select. Android-based device to run DJI Agras.

13. USB-C Charging Port

Use to charge the remote controller.

14. Dongle Compartment Cover

Open the cover to mount or remove the 4G dongle.

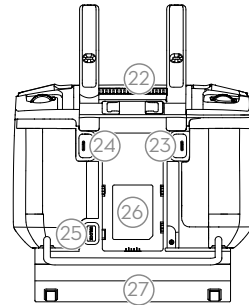
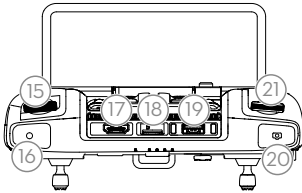

- 15. **Spray Rate Dial**
Turn to adjust the spray rate in Manual operation mode.
- 16. **Spray Button**
Press to start or stop spraying in Manual operation mode.
- 17. **HDMI Port**
For video output.
- 18. **microSD Card Slot**
Used to insert a microSD card.
- 19. **USB-A Port**
Used to connect devices such as an RTK Dongle, or to connect to a computer to update firmware and obtain data stored in the remote controller via the DJI Assistant 2 software.
- 20. **FPV / Map Switch Button**
In Operation View in DJI Agras, press to switch between FPV and the Map View.
- 21. **Aircraft Control Switch Dial**
Turn the dial to switch among the aircraft when using Multi-Aircraft Control function (supported later).
- 22. **Air Outlet**
Used for heat dissipation. DO NOT cover the air vent during use.
- 23. **Button C1 (customizable)**
When planning a field, press the button to switch between Obstacle mode and Waypoints mode. The function of the button cannot be customized while planning a field.
When not planning a field, use the app to customize the button.
- 24. **Button C2 (customizable)**
When planning a field, press the button to add a waypoint or an obstacle point. The function of the button cannot be customized when planning a field.
When not planning a field, use the app to customize the button.
- 25. **Battery Release Button**
- 26. **Battery Compartment**
Used to mount an external Intelligent Battery.
- 27. **Handle**

Aircraft

Aircraft Profile

The T20 uses a dedicated DJI industrial flight controller to provide multiple flight modes and operation modes for various applications. The omnidirectional digital radar provides terrain following to guide the aircraft to maintain a constant distance above crops in specific operation modes and is capable to actively circumvent obstacles in all horizontal directions. Functions such as operation resumption, system data protection, empty tank warning, low battery level warning, and RTH are also available.

Flight Modes

The aircraft will fly in P-mode by default. Users can switch between flight modes by toggling the Flight Mode switch on the remote controller when A-mode is enabled in the app.

P-mode (Positioning): The aircraft utilizes GNSS or the RTK module for positioning. When the GNSS signal is strong, the aircraft uses GNSS for positioning. When the RTK module is enabled and the differential data transmission is strong, it provides centimeter-level positioning. It will revert to A-mode when the GNSS signal is weak or when the compass experiences interference.

A-mode (Attitude): GNSS is not used for positioning and the aircraft can only maintain altitude using the barometer. The flight speed in A-mode depends on its surroundings such as the wind speed.

Attitude Mode Warning

In A-mode, the aircraft cannot position itself and is easily affected by its surroundings, which may result in horizontal shifting. Use the remote controller to position the aircraft.

Maneuvering the aircraft in A-mode can be difficult. Avoid flying in confined spaces or in areas where the GNSS signal is weak. Otherwise, the aircraft will enter A-mode, leading to potential flight risks. Land the aircraft in a safe place as soon as possible.

Operation Modes

The T20 provides Route, A-B Route, Manual, and Manual Plus operation modes. Users can use DJI Agras to switch between A-B Route, Manual, and Manual Plus.

Route Operation Mode

After the operation area and obstacles have been measured and settings have been configured, DJI Agras uses a built-in intelligent operation planning system to produce a flight route based on the user's input. Users can invoke an operation after planning a field. The aircraft will begin the operation automatically and follow the planned flight route. Operation resumption, altitude stabilization, obstacle avoidance, and auto obstacle circumvention of the radar module are available in Route operation mode. Use the app to adjust the spray amount and flying speed. Route operation mode is recommended for large spray area.

Field Planning

DJI Agras supports multiple planning methods for various applications.

Walk with RTK

There are two methods to plan the field by walking with RTK: RTK Dongle and Handheld RTK. Walking

with an RTK dongle uses the RTK dongle connected to the remote controller to record measurements, while walking with a handheld RTK uses the D-RTK 2 mobile station to record measurements. Make sure that the aircraft is powered off when planning your flight route.

The following descriptions use walking with RTK dongle as an example. Walking with a handheld RTK is similar to walking with an RTK dongle except users should walk with a mobile station instead of a remote controller.

1. Make sure that the RTK dongle is mounted to the remote controller.
2. Power on the remote controller, swipe from the top of the screen, and make sure that USB is disabled.
3. Go to the home screen in the app, tap Plan a Field, and select RTK Dongle. If both the RTK dongle and D-RTK 2 mobile station are connected, tap Plan a Field, then Walk with RTK, and select RTK Dongle.
4. Go to , tap RTK to select the RTK source, and complete configuration. Wait until the system status bar in the upper left corner of the screen turns green, indicating that RTK positioning is in use.
5. Walk with the remote controller alongside the boundary of the operation area and tap Waypoint C2 or press the C2 button on the remote controller at turning points.
6. Mark any obstacles:

Use one of the two methods below to mark any obstacles in a target field.

- ① Tap Obstacle Mode C1 onscreen or press the C1 button on the back of the remote controller. Next, walk with the remote controller around the obstacle and tap Add Obstacle C2 onscreen or press the C2 button to add points for the obstacle. Finally, tap Waypoints Mode C1 or press the C1 button when finished.
- ② Tap Obstacle Mode C1 onscreen or press the C1 button on the back of the remote controller. Next, walk with the remote controller to the obstacle, and then tap Circle. A red circle will appear on the map. Drag the circle center to adjust the position of the obstacle, and drag the red point on the circumference to adjust the radius of the obstacle. Finally, tap Waypoints Mode C1 or press the C1 button when finished.
7. Continue measuring the field by walking with the remote controller alongside the boundary and adding waypoints at each corner of the field. Tap Done when the field has been measured and all obstacles have been marked. The app produces a flight route according to the perimeter and obstacles of the field.
8. Add calibration point: Walk with the remote controller to the location of each calibration point. Tap Calibration Point onscreen.

The calibration points are used to offset the bias of the flight route caused by the positioning difference. Choose at least one existing landmark as the fixed reference point for calibration when executing the same operation. If none are available, use an easily identifiable object such as a metal stake.



When using the D-RTK 2 mobile station for field planning, refer to the D-RTK 2 Mobile Station User Guide to link the remote controller and mobile station, and make sure that the mobile station is the device controlled by the remote controller.

Walk with RC

Users should walk along the boundary of the field or the obstacles with the remote controller for measurements. Make sure that the aircraft is powered off when planning your flight route.

1. Power on the remote controller and enter DJI Agras. Tap Plan a Field and select Walk with RC.
2. Wait until the GNSS signal is strong. The satellite count should be no less than 10. Positioning accuracy may vary by +/-2 meters. Complete the remaining steps by walking with the remote controller following the same instructions as the Walk with RTK section.

Fly the Aircraft

Users can fly the aircraft to desired positions and use the app or the remote controller to add waypoints for outlining areas and measuring obstacles.

1. Power on the remote controller, enter DJI Agras, and then power on the aircraft.
2. Tap Plan a Field and select Fly the Aircraft. Complete the remaining steps by flying the aircraft following the same instructions as the Walk with RTK section.

DJI Terra

1. Make sure to read the DJI Terra User Manual for field planning before sharing the planned data to DJI AG platform or storing the data to the microSD card in the remote controller.
2. Using the planning data
 - a. Download from the DJI AG platform:

To view the data on the platform, go to the home screen of DJI Agras and tap  to synchronize data. Select the desired data for field editing.
 - b. Import from the microSD card:

Make sure that the remote controller is powered off. Insert the microSD card with the planning data from DJI Terra into the microSD card slot on the T20 remote controller. Next, go to the home screen of DJI Agras. Select the data in the prompted window and import it. To view the data, go to  task management on the home screen. Select the desired data for field editing.

Field Editing

Tap Field Edit on the onscreen map to enter Edit Status.

1. Edit Waypoints

Move: Drag the waypoint to move.

Fine Tuning: Tap the waypoint. In the Waypoints tag in Field Edit, and tap Fine Tuning buttons. Tap Previous or Next to switch between different waypoints.

Delete: Tap the  icon in the Waypoints tag or tap the waypoint twice to delete a selected waypoint.

2. Adjust Route

The following parameters can be adjusted on the map.

Route Direction: Tap and drag the  icon near the route to adjust the flight direction of the planned route. Tap the icon to show the Fine Tuning menu and adjust.

The following parameters can be adjusted under the Route tag in Field Edit settings.

Widen Overall Margin: Adjust the safety margin between the route and the edge of the field.

Widen One Side: Tap any edge of the field, then enable this option and adjust the single safety margin for the corresponding edge. Tap Previous or Next to switch between different edges.

Line Spacing: Adjust the line spacing between two neighboring lines.

Obstacle Edge Safety Distance: Adjust the safety margin between the route and the edge of the obstacle.

3. Edit Obstacles

To choose the shape and size of the obstacle in the menu, tap and hold the marked obstacle or the position needed to mark an obstacle on the screen.

Tap the obstacle on the screen which has waypoints added, then follow the Edit Waypoints instructions to edit the added waypoints for complete obstacle information.

4. Tap Back, then Done, name the operation, choose crop, and configure other parameters.

Performing an Operation

1. Power on the remote controller. Place the aircraft at one of the previously set calibration points and power it on.
2. Go to the home screen in DJI Agras and tap Execute Operation to enter the Operation View.
3. Tap  to select a field in Fields tag.
4. Tap Edit to edit the waypoints and route again.
5. Tap Invoke.
6. Tap Rectify Offset and then Rectify Aircraft Position, or adjust the route position via the Fine Tuning buttons and tap OK.
7. Tap Start, set operation parameters, and tap OK.
8. Take off and perform the operation.

- ① If you fly to the targeted height, move the slider to start spraying.
- ② If the aircraft is on the ground, set an appropriate auto-takeoff height, move the slider to take off, and start spraying.



- Only take off in open areas and set an appropriate auto-takeoff height according to the operating environment.
 - The operation is automatically cancelled if the motors are started before beginning the operation. You will need to recall the operation in the task list.
 - Once started, the aircraft flies to the starting point of the route and locks its heading in the direction of the first turning point for the duration of the flight route. During operation, users cannot control the aircraft heading via the control stick.
 - The aircraft does not spray while flying along line spacing, but automatically sprays while flying along the rest of the route. Users can adjust the spray amount, flying speed, and the height above vegetation in the app.
 - An operation can be paused by moving the control stick slightly. The aircraft will hover and record the breakpoint, and then the aircraft can be controlled manually. To continue the operation, select it again from the Executing tag in , and the aircraft will return to the breakpoint automatically and resume the operation. Pay attention to aircraft safety when returning to a breakpoint.
 - Users can set the action the aircraft will perform after the operation is completed in the app.
-

A-B Route Operation Mode

In A-B Route operation mode, the aircraft travels along a pre-planned route. Operation resumption, data protection, altitude stabilization, obstacle avoidance, and auto obstacle circumvention functions of the radar module are available in this mode. Use the app to adjust the flying speed and spray amount. A-B Route operation mode is recommended for large, triangular, or rectangular spray areas.

Operation Route

The aircraft travels along a planned square zig-zag route after recording turning points A and B. Under optimal working conditions, the obstacle avoidance and auto obstacle circumvention functions are available and the aircraft maintains the same distance from the vegetation. The length of the dotted lines, called line spacing, can be adjusted in the app. If users adjust the heading for points A and B after the points are recorded, the turning angles for the turning points of the operation route will change according to the preset heading for points A and B. The shape of the operation route will also change, for example, as Route L' and Route R' in the figure below.

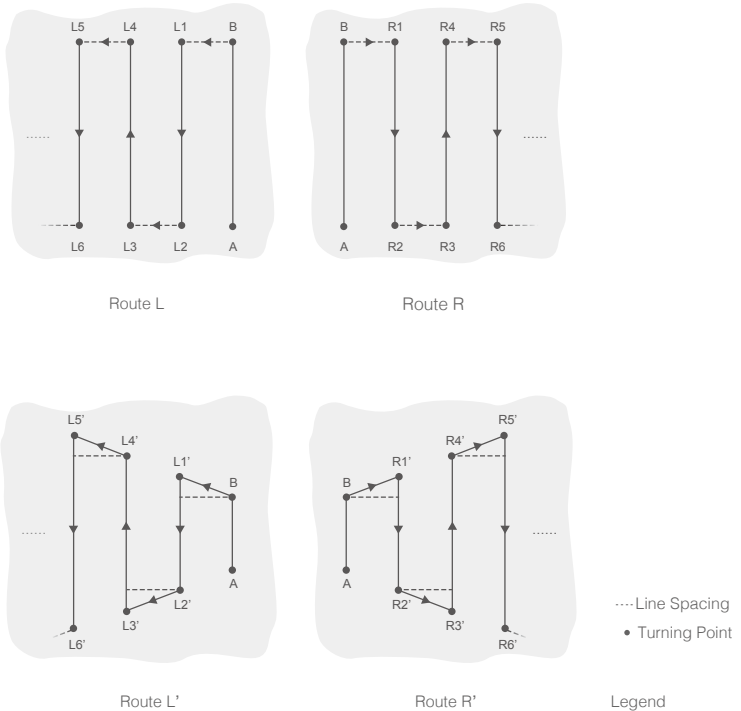

Operation Procedure

-  • Maintain VLOS of the aircraft at all times.
 - Make sure that the GNSS signal is strong. Otherwise, A-B Route operation mode may be unreliable.
-

-  Make sure to inspect operating environments before flying.
-

Set the operation mode switch button to M (Manual operation mode) when a strong GNSS signal is present and the onscreen display is Manual Route (GNSS) or Manual Route (RTK). Fly the aircraft to a safe height.

1. Record Points A and B in order

Fly the aircraft to the starting point, depicted as Point A or B, hover, and tap Point A or B onscreen or press the preset customizable button on the remote controller. Point A or B appears on the map and the aircraft status indicators blink red or green after recording the starting points. If the heading for Point A or B is required to be adjusted, the heading for Point A should be adjusted after Point A is recorded and then users can record Point B and adjust the heading for Point B.

-  • Points A and B cannot be recorded if the spray tank is empty or the flying speed of the aircraft is higher than 0.4 m/s.
 - Make sure to record Point A before Point B, and that the distance between Point A and B is more than 1 m.
 - Update Point B by flying the aircraft to a new position to record. Note that if Point A is updated, Point B must be too.
 - For optimal performance, it is recommended to keep the direction of Point A to B parallel to one side of the polygonal spray area.
-

2. Adjust heading for Point A and B

After Point A or B is recorded, tap Adjust A or B Heading onscreen, and move the yaw stick on the remote controller. The heading of the aircraft refers to the heading for Point A or B that is indicated by a dotted line on the screen. Tap Adjust A or B Heading again to set the current heading for Point A or B. After adjusting the heading for Point A, Point B cannot be recorded inside of a range of 30° on the left or right of the dotted line indicating the heading for Point A. When adjusting the heading for Point B, the dotted line indicating the heading for Point B cannot be inside of a range of 30° on the left or right of the line from A to B. Take note of the prompts in the app when operating.

-  The heading for Point A or B cannot be set when the rotating speed of the aircraft's heading is higher than 15°/s.
-

3. Select the route

After Point A and B are recorded, the app produces Route R or Route R' by default. Tap Change Direction on the lower right corner of the screen to switch to Route L or Route L'.

4. Set the operation parameters

Tap Parameter Configuration on the left of the screen to set the spray amount, flying speed, line spacing, height above the vegetation, and enable banked turning. To set the desired height above the vegetation, users can also tap the height value displayed on the left of the screen. Under optimal

working conditions, the radar module starts working automatically and maintains the spraying distance between aircraft and vegetation after performing the operation. Refer to [Omnidirectional Digital Radar \(p. 23\)](#) for more information.

-  The line spacing cannot be adjusted during operation. Switch to Manual operation mode to adjust the value, then return to A-B Route operation mode.
-

5. Performing an operation

Tap Start on the lower right corner of the screen and move the slider to start the operation.

-  If, after recording Points A and B, you fly the aircraft more than five meters away from Point B, Resume appears at the lower right corner of the screen. Tap Resume, and the aircraft automatically flies to Point B to perform the operation.
 - If the GNSS signal is weak during the operation, the aircraft enters Attitude mode and exits from A-B Route operation mode. Operate the aircraft with caution. The operation can be resumed after the GNSS signal is recovered.
 - If you press the A or B button during operation while the flying speed of the aircraft is lower than 0.3 m/s, the data for Points A and B of the current route is erased and the aircraft hovers in place.
-

-  Line spacing can be customized from 3-10 m in the app. It is set to a length of 6 m by default.
 - Users cannot control the aircraft heading via the control stick during the operation.
 - When using the control sticks to control the aircraft in A-B Route operation mode, the aircraft automatically switches to Manual operation mode, completes the corresponding flight behavior, and then hovers. To resume the operation, tap Resume onscreen. The aircraft resumes flying along the operation route. Refer to [Operation Resumption \(p. 21\)](#) for more information.
 - Even though the heading of the aircraft cannot be adjusted, use the control sticks to avoid obstacles if the obstacle avoidance function of the radar module is disabled. Refer to [Manual Obstacle Avoidance \(p. 22\)](#) for more information.
 - During the operation, the aircraft does not spray liquid while flying along the route parallel to the line from A to B, but automatically sprays liquid while flying along the other parts of the route.
-

Manual Operation Mode

Tap the operation mode switch button in the app and select M to enter Manual operation mode. In this mode, you can control all the movements of the aircraft, spray liquid via the spray button of the remote controller, and adjust the spray rate via the dial. Refer to [Controlling the Spraying System \(p. 34\)](#) for more information. Manual operation mode is ideal when the operating area is small.

Manual Plus Operation Mode

Tap the operation mode switch button in the app and select M+ to enter Manual Plus operation mode. In this mode, the maximum flying speed of the aircraft is 7 m/s (customizable in the app), the heading is locked, and all other movement can be manually controlled. Users can disable the M+ heading lock in the app. Under optimal working conditions, the radar module maintains the spraying distance between

aircraft and vegetation if the altitude stabilization function is enabled. Press the corresponding buttons onscreen or customizable buttons on the remote controller (if customized) to steer the aircraft left or right. The aircraft automatically sprays when accelerating forward, backward or diagonally, but does not spray when flying sideward. Manual Plus operation is ideal for irregularly-shaped operating areas.



- The line spacing cannot be adjusted during operation. Switch to Manual operation mode to adjust the value, then return to Manual Plus operation mode.
- The spray rate will be adjusted automatically according to the flying speed.
- In the app, users can adjust the spray amount, flying speed and height above the vegetation.

Operation Resumption

When exiting a Route or an A-B Route operation, the aircraft records a breakpoint. The Operation Resumption function allows you to pause an operation temporarily to refill the spray tank, change the battery, or avoid obstacles manually. Afterwards, resume operation from the breakpoint.

Recording a Breakpoint

Users can record the location of an aircraft as a breakpoint. If the GNSS signal is strong, a breakpoint is recorded in the following scenarios during Route or A-B Route operations.

1. Tap the Pause or End button at the lower right corner of the screen. Note: tapping the End button during an A-B Route operation does not make the aircraft record a breakpoint. The operation ends immediately and cannot be resumed.
2. Initialize RTH.
3. Toggle the pause switch.
4. Push the pitch or roll stick in any direction on the remote controller.
5. Obstacle detected. The aircraft brakes and enters obstacle avoidance mode.
6. Radar module error detected when the obstacle avoidance function is enabled.
7. The aircraft reaches its distance or altitude limit.
8. Empty tank.
9. If the GNSS signal is weak, the aircraft enters Attitude mode and exits the Route or A-B Route operation. The last position where there was a strong GNSS signal is recorded as a breakpoint.



- Make sure that the GNSS signal is strong when using the Operation Resumption function. Otherwise, the aircraft cannot record and return to the breakpoint.
- The breakpoint is updated as long as it meets one of the above conditions.
- If the operation is paused for longer than 20 minutes during an A-B Route operation, the system automatically switches to Manual operation mode and erases the breakpoint.

Resuming Operation

1. Exit a Route or A-B Route operation through one of the above methods. The aircraft records the current location as the breakpoint.
2. Fly the aircraft to a safe location after operating the aircraft or removing the conditions for recording a breakpoint.

3. Tap Resume at the lower right corner of the screen to continue the operation. To resume operation when the end button has been used to exit a Route operation, select the Executing tag in the operation list and then select the operation.
4. A prompt will appear in the app asking the user to return to the route. Users can select from returning to the breakpoint or returning to the operating route at the nearest possible junction by following a perpendicular line.
5. If obstacle avoidance is required when returning to the route, users can enable the aircraft to move forward, backward, and sideward. Refer to [Manual Obstacle Avoidance \(p. 22\)](#) for more information.

Typical Applications

In Route or A-B Route operation mode, users can control the aircraft forward, backward, and sideward, avoiding obstacles along the operation route, or in an emergency such as when the aircraft is experiencing abnormal behavior. The following instructions describe how to avoid obstacles manually:

Manual Obstacle Avoidance

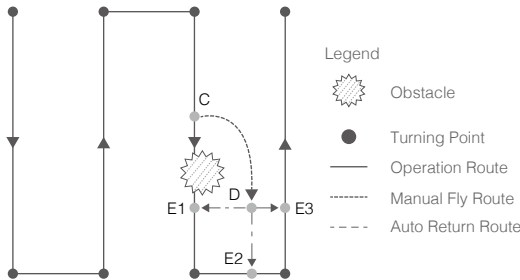

1. Exiting a Route or A-B Route operation

In both modes, when using the control sticks to control the aircraft forward, backward, or sideward, the aircraft automatically switches the current mode to Manual operation mode, pauses the operation, records the current position as a breakpoint (Point C), completes the corresponding flight behavior, and hovers.

⚠ When pushing the control sticks to exit the operation, the aircraft requires a braking distance. Make sure that there is a safe distance between the aircraft and any obstacles.

2. Avoiding an Obstacle

After switching to Manual operation mode, users can control the aircraft to avoid the obstacle from Point C to D.

3. Resuming Operation

Tap Resume in the app. If the aircraft is in the operating area, there will be a prompt in the app. Select among the three project points E1, E2, or E3. The aircraft flies from Point D to the selected

project point following a perpendicular line.





- The amount of selectable project points is related to the position of the aircraft. Select according to the app display.
- Make sure that the aircraft has completely avoided the obstacle before resuming operation.
- In the event of an emergency, make sure that the aircraft is operating normally and fly the aircraft manually to a safe area to resume operation.



Repeat the instructions above to exit and resume operation in the event of an emergency when returning to the route, such as whenever obstacle avoidance is required.

System Data Protection

In Route or A-B Route operation mode, the System Data Protection feature enables the aircraft to retain vital system data such as operation progress and breakpoints after the aircraft is powered off to replace a battery or refill the spray tank. Follow the instructions in Operation Resumption to resume the operation after restarting the aircraft.

During Route operations, in situations such as when the app crashes or the remote controller disconnects from the aircraft, the breakpoint will be recorded by the flight controller and recovered automatically in the app once the aircraft is reconnected. If recovery is not performed automatically, users can perform the operation manually. Go to Operation View, select  , then Advanced Settings, and tap Continue Unfinished Task. Recall the operation in the Executing tag in the operation list. Before using this function, make sure that the option "Continue operation if remote control signal is lost" in Aircraft Settings is enabled.

Omnidirectional Digital Radar

Profile

The all-new omnidirectional digital radar works during both day and night, without being affected by light or dust. In an optimal operating environment, the radar module can predict the distance between the aircraft and the vegetation or other surfaces in forward, rear, and downward directions to fly at a constant distance to ensure even spraying and terrain following capability. The omnidirectional digital radar can also detect obstacles 30 m away from the aircraft. The radar module supports obstacle avoidance in all horizontal directions, and effectively senses the environment to help circumvent obstacles in all horizontal directions in both Route and A-B Route operation modes. In addition, the radar module limits the descent speed of the aircraft according to the distance between the aircraft and ground, to provide a smooth landing.

The altitude stabilization and obstacle avoidance functions of the radar module are enabled by default, and can be disabled in the app. When enabled, the aircraft flies above the vegetation at a constant spraying distance in Route, A-B Route, and Manual Plus operation modes. In Manual operation mode, the radar module can also measure the spraying distance above the vegetation or other surfaces, but the aircraft is not be able to fly at a constant spraying distance. The obstacle avoidance function can be used in any mode. Auto obstacle circumvention is disabled by default. Users can enable it in the app.

Detection Range

The obstacle detection range of the radar module is 360° in the horizontal direction and $\pm 15^\circ$ in the vertical direction, as shown in the figure below, and the detection distance is 1.5 - 30 m. Note that the aircraft cannot sense obstacles that are not within the detection range. Fly with caution. For the four gray areas with an angle approx. 10° for each area in the figure, the detection performance of the radar module may be reduced, due to the obstruction of the frame arms and landing gear. Fly with caution.

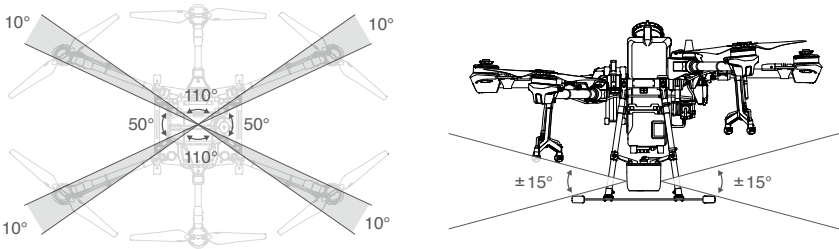

⚠ The effective detection distance varies depending on the size and material of the obstacle. For example, when sensing strong reflective objects such as buildings that have a radar cross section (RCS) of more than -5 dBsm, the effective detection distance is around 20 m. When sensing objects such as power lines that have a RCS of -10 dBsm, the distance is around 15 m. When sensing objects such as dry tree branches that have a RCS of -15 dBsm, the distance is around 10 m. Obstacle sensing may malfunction or be invalid in areas outside of the effective detection distance.

Obstacle Avoidance Function Usage

Obstacle avoidance is used in the following two scenarios:

1. The aircraft begins to decelerate when it detects an obstacle is 15 m away and hovers in place when 2.5 m away from the obstacle. Users can not accelerate in the direction of the obstacle, but can fly in a direction away from the obstacle.
2. The aircraft immediately brakes and hovers if it detects an obstacle nearby. Users cannot control the aircraft when it is braking.

When the aircraft is hovering, it is in Obstacle Avoidance mode. Users can fly in a direction away from the obstacle to exit Obstacle Avoidance mode and regain full control of the aircraft.

Altitude Stabilization Function Usage

1. Make sure that you have enabled the altitude stabilization function of the radar module in the app.
2. Enter the desired operation mode, and configure the desired spraying distance.
3. If the operating environment is ideal, the aircraft flies above the vegetation at the preset height.

Obstacle Circumvention Function Usage

1. Make sure that you have enabled the obstacle avoidance function of the radar module in the app, and enable Auto Obstacle Avoidance. Note that Auto Obstacle Avoidance is disabled if Obstacle Avoidance is disabled.
2. Perform a Route or A-B Route operation. During auto flight, when obstacles are detected, the aircraft plans a flight route to circumvent the obstacles, and the app shows the real-time obstacle radar map and planned flight route.
3. The aircraft flies along the planned flight route to circumvent the obstacles. Once the obstacles are circumvented, the aircraft returns to the operation route.
4. The aircraft hovers in place if a prompt is received in the app indicating that the aircraft failed to circumvent the obstacle. Users can manually control the aircraft to avoid the obstacles. Refer to [Manual Obstacle Avoidance \(p. 22\)](#) for more information.

Radar Usage Notice



- DO NOT touch or let your hands or body come in contact with the metal parts of the radar module when powering on or immediately after flight as they may be hot.
- In Manual operation mode, users have complete control of the aircraft. Pay attention to the flying speed and direction when operating. Be aware of the surrounding environment and avoid the blind spots of the radar module.
- Obstacle Avoidance is disabled in Attitude mode.
- Obstacle Avoidance is adversely affected due to the obstruction of the aircraft body when aircraft pitch exceeds 15°. Slow down and fly with caution.
- When sensing objects that have a vertical inclination of more than 5° such as an inclined line or inclined utility pole, the sensitivity of the radar module may be reduced. Fly with caution.
- The radar module enables the aircraft to maintain a fixed distance from vegetation only within its working range. Observe the aircraft's distance from vegetation at all times.
- Operate with extra caution when flying over inclined surfaces. Recommended maximum inclination at different aircraft speeds: 10° at 1 m/s, 6° at 3 m/s, and 3° at 5 m/s.
- Maintain full control of the aircraft at all times and do not rely on the radar module and DJI Agras app. Keep the aircraft within VLOS at all times. Use your discretion to operate the aircraft manually to avoid obstacles.
- Comply with local radio transmission laws and regulations.
- The radar module can only function properly in flat landscapes. It cannot function in sloping landscapes with inclinations more than 10° or in landscapes with sudden changes in elevation.
- The sensitivity of the radar module may be reduced when operating several aircraft within a short distance. Operate with caution.
- Before use, make sure that the radar module is clean and the outer protective cover is not cracked, chipped, sunken, or misshapen.
- DO NOT attempt to disassemble any part of the radar module that has already been mounted prior to shipping.
- The radar module is a precision instrument. DO NOT squeeze, tap, or hit the radar module.
- Land the aircraft on flat ground to avoid damage to the radar module from raised objects.

-  • If the radar module frequently detects obstacles incorrectly, check to make sure the mounting bracket and the aircraft landing gear are properly secured. If the radar module still does not work, contact DJI Support or a DJI authorized dealer.
 - Keep the protective cover of the radar module clean. Clean the surface with a soft damp cloth and air dry before using again.
-

Empty Tank



Profile

A prompt appears in the app and the aircraft hovers in place when the spray tank is empty. In Route, A-B Route, and Manual Plus operation modes the aircraft can also be set to ascend or RTH instead of hovering.

Usage

1. When an empty tank warning appears in the app, the sprinklers automatically turn off.
2. Make sure that the aircraft is in Manual operation mode. Land the aircraft and stop the motors. Refill the spray tank and tightly secure the cover.
3. Take off in Manual operation mode and fly the aircraft to a safe position. Enter the desired mode to continue the operation.

Return to Home (RTH)

 **Home Point:** The default home point is the first location where your aircraft received strong GNSS signals . Note that the white GNSS icon requires at least four bars before the signal is strong. The aircraft status indicators blink several times after the home point has been recorded.

RTH: RTH brings the aircraft back to the last recorded home point.

There are two types of RTH: Smart RTH and Failsafe RTH.

Smart RTH

Press and hold the RTH button on the remote controller when GNSS is available to enable Smart RTH. Both Smart and Failsafe RTH use the same procedure. With Smart RTH, you may control the speed and altitude of the aircraft to avoid collisions when returning to the home point. The aircraft status indicators will show the current flight mode during RTH. Press the RTH button once to exit Smart RTH and regain control of the aircraft.

Failsafe RTH

 Failsafe RTH must be enabled in the app. If Failsafe RTH is disabled, the aircraft hovers in place when the remote controller signal is lost. Note that Failsafe RTH is disabled by default in the app.

Failsafe RTH is automatically activated if the remote controller signal is lost for more than three seconds, provided that the home point has been successfully recorded, the GNSS signal is strong , and the RTK module is able to measure the heading of the aircraft. The RTH continues if the remote controller signal is recovered, and users can control the aircraft using the remote controller. Press the RTH button once or toggle the pause switch to cancel RTH and regain control of the aircraft.

RTH Illustration

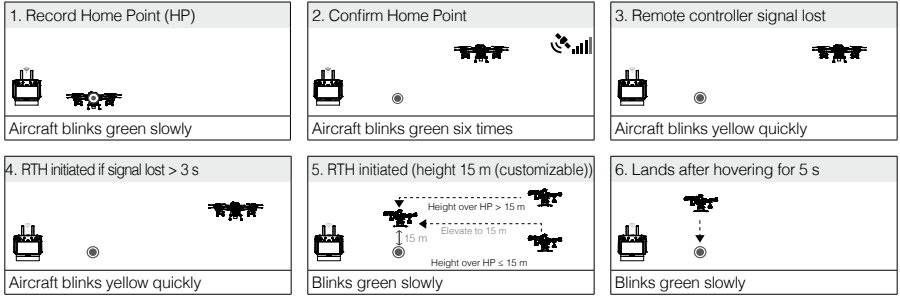







Updating the Home Point

You can update the home point in DJI Agras during flight. There are two ways to set a home point:





1. Set the current coordinates of the aircraft as the home point.
2. Set the current coordinates of the remote controller as the home point.



 Make sure the space above the remote controller's GNSS module (located inside the place above the flight switch mode) is not obstructed and that there are no tall buildings around when updating the home point.

Follow the instructions below to update the home point:

1. Go to DJI Agras and enter Operation View.
2. Tap , then , and select  in Home Point Location settings to set the current coordinates of the aircraft as the home point.
3. Tap , then , and select  in Home Point Location settings to set the current coordinates of the remote controller as the home point.
4. The aircraft status indicators blink green to indicate that the new home point has been set successfully.

RTH Safety Notices

	<p>The aircraft cannot avoid obstacles during RTH if the operating environment is not suitable for the radar module. Users can only control the speed and altitude of the aircraft. Before each flight, it is important to set an RTH altitude that is appropriate for the given environment. Go to Operation View in the app, tap , then , and Set Return to Home Altitude.</p>
	<p>If the aircraft is flying under 3 m and RTH (including Smart and Failsafe RTH) is triggered, the aircraft first automatically ascends to 3 m from the current altitude. You cannot control the aircraft during this ascent. In Smart RTH, you can exit RTH to cancel automatic ascent by pressing the RTH button once.</p>
	<p>The aircraft automatically descends and lands if RTH is triggered when the aircraft flies within a 5 m radius of the Home Point.</p>

	<p>The aircraft cannot return to the home point when the GNSS signal is weak (the GNSS icon displays red) or is unavailable.</p>
	<p>When the RTH altitude is set to more than 3 m and the aircraft is ascending between 3 m and the preset RTH altitude, the aircraft stops ascending and immediately return to the home point if the throttle stick is pushed.</p>

Obstacle Avoidance During RTH

In an optimal operating environment, obstacle avoidance during RTH is available. If there is an obstacle within 20 m of the aircraft, the aircraft decelerates and then stops and hovers. If the aircraft comes within 6 m of the obstacle while decelerating, the aircraft stops, flies backward to a distance of approximately 6 m from the obstacle, and hovers. The aircraft exits the RTH procedure and waits for further commands.

Landing Protection Function

Landing Protection activates during auto landing. The procedure is as follows:

1. After arriving at the home point, the aircraft descends to a position 3 m above the ground and hovers.
2. Control the pitch and roll sticks to adjust the aircraft position and make sure the ground is suitable for landing.
3. Pull down the throttle stick or follow the onscreen instructions in the app to land the aircraft.

Low Battery and Low Voltage Warnings

The aircraft features a low battery warning, critical low battery warning, and critical low voltage warning.

1. Low Battery Warning: The aircraft status indicators slowly blink red. Fly the aircraft to a safe area and land it as soon as possible, stop the motors, and replace the batteries.
2. Critical Battery Warning or Critical Voltage Warning (the battery voltage is lower than 47.6 V): the aircraft status indicators rapidly blink red. The aircraft begins to descend and land automatically.



Users can set the threshold of low battery warnings in the app.

RTK Functions

The T20 has an onboard D-RTK. The heading reference of the aircraft from the dual antennas of the onboard D-RTK is more accurate than a standard compass sensor and can withstand magnetic interference from metal structures and high-voltage power lines. When there is a strong GNSS signal, the dual antennas activates automatically to measure the heading of the aircraft.

The T20 supports centimeter-level positioning to improve agricultural operation when used with the DJI D-RTK 2 Mobile Station. Follow the instructions below to use the RTK functions.

Enable/Disable RTK

Before each use, make sure that the aircraft RTK positioning function is enabled and the RTK signal source is correctly set to either D-RTK 2 Mobile Station or Network RTK. Otherwise, RTK cannot be used

for positioning. Go to Operation View in the app, tap , and select RTK to view and set.



Make sure to disable the aircraft RTK positioning function if not in use. Otherwise, the aircraft is not able to take off when there is no differential data.

Using with the DJI D-RTK 2 Mobile Station

1. Refer to the D-RTK 2 Mobile Station User Guide for more information about completing the linking between the aircraft and the mobile station and setting up the mobile station.
2. Power on the mobile station and wait for the system to start searching for satellites. The RTK status icon on top of the Operation View in the app shows  to indicate that the aircraft has obtained and used the differential data from the mobile station.

Using with the Network RTK Service

The Network RTK service uses the remote controller instead of the base station to connect to an approved Network RTK server for differential data. Keep the remote controller on and connected to the internet when using this function.

1. Make sure that the remote controller is connected to the aircraft and has access to the internet.
2. Go to Operation View in the app, tap , and then RTK. Set the RTK signal source to Custom Network RTK, and input the network information.
3. Wait for the remote controller to be connected with the Network RTK server. The RTK status icon on top of the Operation View in the app shows  to indicate that the aircraft has obtained and used the RTK data from the server.

Aircraft LEDs

There are LEDs on all of the frame arms marked M1 to M6. The LEDs on frame arms M1, M2, and M6 are front LEDs, indicating the aircraft front. The LEDs on frame arms M3 and M5 are aircraft status LEDs, indicating the status of the aircraft. Refer to [Appendix \(p. 52\)](#) for more information on aircraft statuses. The LEDs on the M4 frame arm constantly glows solid red so the aircraft can be easily identified during night operations.

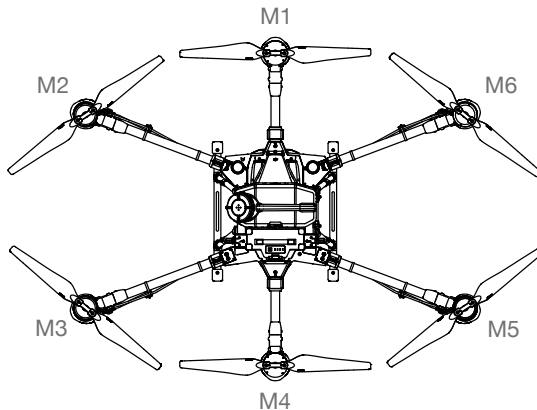

Remote Controller

Profile

The remote controller uses the DJI OcuSync 2.0 image transmission system, which has a maximum control distance of up to 1.86 mi (3 km). It includes a dedicated, Android-based display that runs DJI Agras independently for operation planning and aircraft status display. Its Multi-Aircraft Control mode (supported later) can be used to coordinate the operation of up to five aircraft at the same time to improve operation efficiency.

Using the Remote Controller

Powering the Remote Controller On and Off

Both the internal battery and external battery can be used to supply power to the remote controller. The battery level is indicated via the battery level LEDs on the remote controller or on the external battery.

Follow the steps below to power on the remote controller:

1. When the remote controller is powered off, press the power button once to check the current battery level of the internal battery. Press the battery level button on the external battery to check the current battery level of the external battery. If the battery level is too low, recharge before use.
2. Press the power button once, then press and hold to power on the remote controller.
3. The remote controller beeps when powered on. The status LED glows solid green when linking is complete.
4. Repeat Step 2 to power off the remote controller.

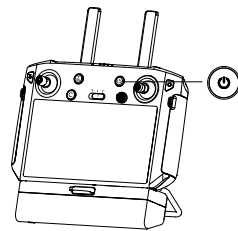



 When using an external Intelligent Battery, it is still necessary to make sure that the internal battery has some power. Otherwise, the remote controller cannot be powered on.

Charging the Batteries

Internal Battery

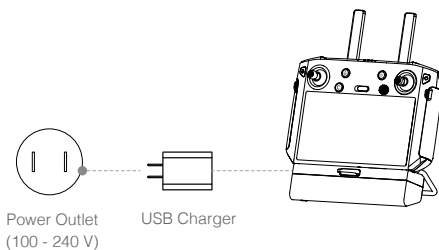
Charge the internal battery of the remote controller using the USB charger and USB-C cable.



-  Use an official DJI USB charger to charge the remote controller. If not, a USB charger certified FCC/CE rated 12 V/2 A is recommended.
- The battery will deplete when stored for an extended period of time. Recharge the battery at least once every three months to prevent over discharging.

The battery level LEDs on the remote controller indicates the status while charging. See the table below for details.

LEDs	Description
Blink successively quickly	The battery is being charged using a Quick Charge charger.
Blink successively slowly	The battery is being charged using a normal charger.
Solid	The battery is fully charged.

External Battery

Charge the external Intelligent Battery using the included AC power adapter and charging hub.

1. Place the battery into the charging hub, connect the AC power adapter to the charging hub, and connect the charger to a power outlet (100-240 V, 50/60 Hz).
2. The charging hub automatically charges batteries in order according to the battery power levels from high to low.
3. The Status LED blinks green when charging and turns solid green when fully charged. The charging hub beeps when charging is complete. To stop the beeping, remove the battery or turn off the button on the charging hub.

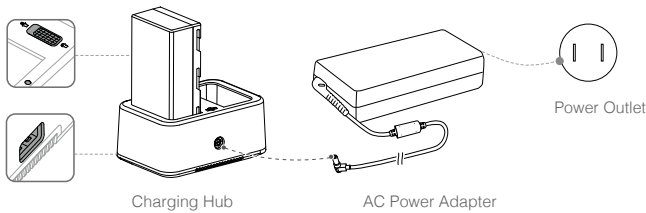

 Fully charge and discharge the battery at least once every three month.

 USB power supply port can be used to charge the mobile device of 5V/2A.

Status LED	Description
Blinks Green	Charging
Solid Green	Fully charged
Blinks Red	Battery charger error. Retry with an official battery charger
Solid Red	Battery error
Blinks Yellow	Battery temperature too high/low. Temperature must be within operating range (5°to 40°C (41°to 104° F))
Solid Yellow	Ready to charge
Blinks Green Alternately	Intelligent Battery not detected

Operating the Aircraft

This section explains how to control the orientation of the aircraft through the remote controller. Control can be set to Mode 1, Mode 2, or Mode 3.

Mode 1

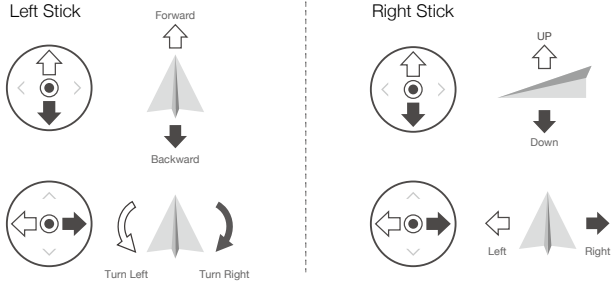

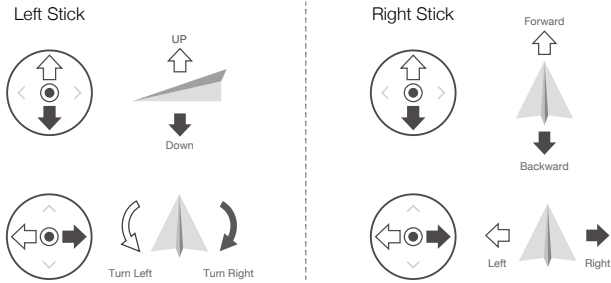

Mode 2

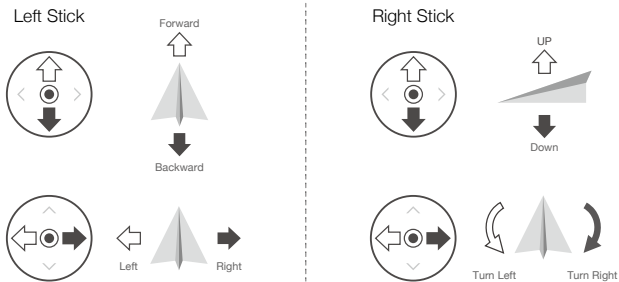

Mode 3

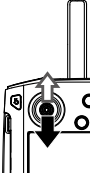
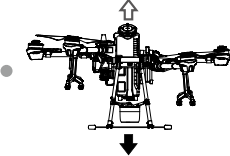
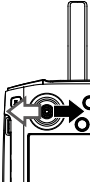
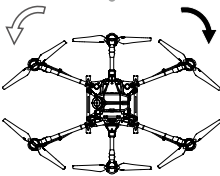
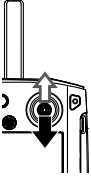
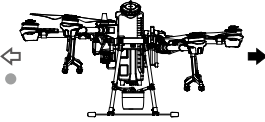
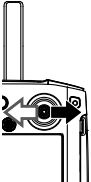

For example, the following description uses Mode 2:

Remote Controller (Mode 2)	Aircraft (● Indicates nose direction)	Remarks
		<p>Throttle Stick: Move the left stick vertically to control the elevation of the aircraft.</p> <p>Push up to ascend and push down to descend. Use the left stick to take off when the motors are spinning at an idle speed. The aircraft hovers in place if the stick is in the center position. The further the stick is pushed away from the center position, the faster the aircraft changes elevation.</p>
		<p>Yaw Stick: Move the left stick horizontally to control the heading of the aircraft.</p> <p>Push left to rotate the aircraft counterclockwise and push right to rotate clockwise. The aircraft hovers in place if the stick is in the center position. The further the stick is pushed away from the center position, the faster the aircraft rotates.</p>
		<p>Pitch Stick: Move the right stick vertically to control the pitch of the aircraft.</p> <p>Push up to fly forwards and press down to fly backwards. The aircraft hovers in place if the stick is in the center position. Push the stick further for a larger pitch angle and faster flight.</p>
		<p>Roll Stick: Move the right control stick horizontally to control the roll of the aircraft.</p> <p>Push the stick left to fly left and right to fly right. The aircraft hovers in place if the stick is in the central position. Push the stick further for a larger roll angle and faster flight.</p>

Controlling the Spraying System

Complete an operation remotely via the spray rate or aircraft control switch dials, or the spray and C1 or C2 buttons.

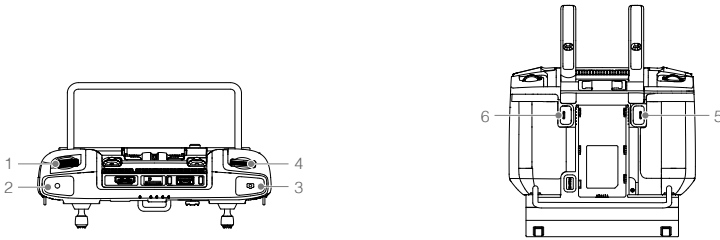

1. Spray Rate Dial

In Manual operation mode, turn left to reduce and right to increase the spray rate.* The app indicates the current spray rate.

2. Spray Button

In Manual operation mode, press to start or stop spraying.

3. FPV / Map Switch Button

In Operation View in DJI Agras, press to switch between FPV and the Map View.

4. Aircraft Control Switch Dial

Turn the dial to switch among the aircraft when using Multi-Aircraft Control function.

5. Button C1

When planning a field, press the button to switch between Obstacle mode and Waypoints mode. The function of the button cannot be customized while planning a field.

When not planning a field, use the app to customize the button. For example, if the button is customized to record Point A, in A-B Route operations, press the button to record Point A of the operation route.

6. Button C2

When planning a field, press the button to add a waypoint or an obstacle point. The function of the button cannot be customized when planning a field.

When not planning a field, use the app to customize the button. For example, if the button is customized to record Point B, in A-B Route operations, press the button to record Point B of the operation route.

* Spray rate may vary according to the nozzle model and viscosity of the liquid.



The table below is a summary for how to control the spraying system in different modes using the remote controller.

Modes	Spray Rate Dial	Spray Button	FPV / Map Switch Button	Aircraft Control Switch Dial	Button C1	Button C2
Route operation mode	/	/	Switch the display	Switch between aircraft	Customizable	Customizable
A-B Route operation mode	/	/	Switch the display	/	Customizable	Customizable
Manual operation mode	Adjust spray rate	Start or stop spraying	Switch the display	/	Customizable	Customizable
Manual Plus operation mode	Adjust spray rate	/	Switch the display	/	Customizable	Customizable
Field Planning	/	/	/	/	Obstacle mode/ Waypoint mode	Add waypoint/ obstacle point

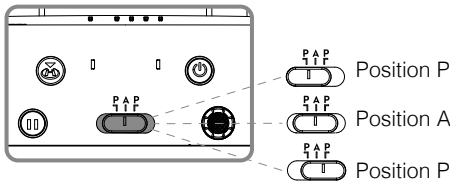
Flight Mode Switch



Position	Flight Mode
P	P-mode (Positioning)
A	A-mode (Attitude)
P	P-mode (Positioning)

Regardless of the position the switch is in on the remote controller, the aircraft begins in P-mode by default. To switch flight modes, first go to Operation View in DJI Agras, tap , then , and enable "Enable Attitude Mode". After enabling attitude mode, toggle the switch to P and then to A to switch the flight mode to Attitude mode.

The aircraft still begins in P-mode by default after powering on, even though A-mode was enabled in the app beforehand. When A-mode is required, toggle the Flight Mode switch as mentioned above after powering on the remote controller and aircraft.

RTH Button

Press and hold the RTH button to bring the aircraft back to the last recorded home point. The LED around the RTH Button blinks white during RTH. Users can control aircraft heading while it flies to the home point. Press this button again to cancel RTH and regain control of the aircraft.

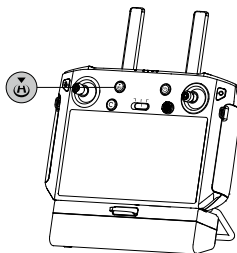

Optimal Transmission Zone

When the angle between the antennas and the back of the remote controller is 80° or 180°, the connection between the remote controller and aircraft can reach its optimal performance.

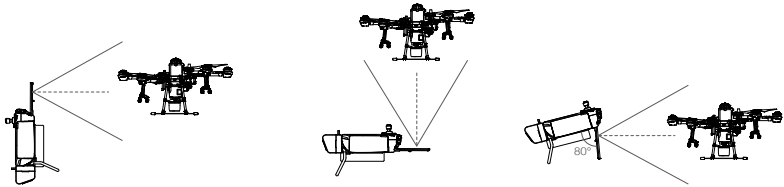

Try to keep the aircraft inside the optimal transmission zone. If the signal is weak, adjust the antennas or fly the aircraft closer.

Button Combinations

Some frequently-used features can be activated by using button combinations. To use button combinations, hold the back button and then press the other button.

Checking the Available Button Combinations

Hold the Back button until the controller vibrates to check button combinations:

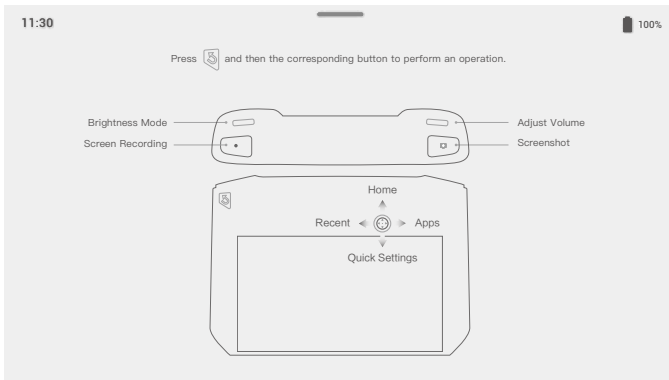

Button Combinations

Using Button Combinations

The functions of the button combinations cannot be changed. The following table displays the function of each button combination.

Button Combinations	Description
Function Button + Aircraft Control Switch Dial (Right Dial)	Adjust the system volume
Function Button + Spray Rate Dial (Left Dial)	Adjust the screen brightness
Function Button + Spray Button	Record the screen
Function Button + FPV / Map Switch Button	Screenshot the screen
Function Button + 5D Button (up)	Return to Homepage
Function Button + 5D Button (down)	Open Quick Settings
Function Button + 5D Button (left)	Check recently opened apps
Function Button + 5D Button (right)	Open App Center

Calibrating the Compass

After the remote controller is used in places with electro-magnetic interference, the compass may need to be calibrated. A warning prompt will appear if the remote controller's compass requires calibration. Tap the warning prompt to start calibrating. In other cases, follow the steps below to calibrate your remote controller.

1. Power on the remote controller.
2. Swipe down from the top of the screen, tap , and scroll down and tap Compass.
3. Follow the diagram on the screen to calibrate your remote controller.
4. The user will receive a prompt when the calibration is successful.

Blocking Third-Party Notifications

To ensure safe flight, it is recommended to disable third-party notifications before each flight. Follow the steps below to disable third-party notifications.





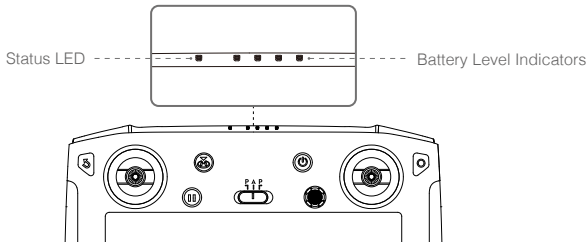











Power on the remote controller. Swipe down from the top of the screen, tap , then Notifications, and enable Do Not Disturb. After this, all the third-party notifications will be displayed in the notification bar only when the DJI Agras app is in use.

Remote Controller LEDs



The battery level indicators display the battery level of the controller. The status LED displays the linking status and warnings for control stick, low battery level, and high temperature.

Status LED	Description
Solid Red	The remote controller is not linked to an aircraft.
Solid Green	The remote controller is linked to an aircraft.
Blinks Blue	The remote controller is linking to an aircraft.
Blinks Red	The temperature of the remote controller is too high or the battery level of the aircraft is low.
Blinks Yellow	The battery level of the remote controller is low.
Blinks Cyan	The control sticks are not centered.

Battery Level Indicators				Battery Level
				75%~100%
				50%~75%
				25%~50%
				0%~25%



Remote Controller Warning Sounds

In scenarios where there is a warning, the remote controller will do so by vibrating and/or beeping. When the controller beeps and the status LED is solid green, this error may be related to the aircraft or flight status, and a warning will appear in DJI Agras. If this error is related to the remote controller, a warning will appear on the screen of the remote controller.

To disable the beeping, power on the remote controller, swipe from the top of the screen, tap , then Sound, and adjust the notification volume.

Linking the Remote Controller

The remote controller is linked to the aircraft by default. Linking is only required when using a new remote controller for the first time. When using the Multi-Aircraft Control function, it is required to link all aircraft to the same remote controller.

1. Power on the remote controller and open DJI Agras. Power on the aircraft.
2. Tap Execute Operation to enter Operation View and tap , then . Tap Single Linking or Multi Linking (if Multi-Aircraft Control is in use), and then tap Starting Linking. The status LED blinks blue and the remote controller beeps twice repeatedly, indicating that the remote controller is ready for linking.
3. Press and hold the power button on the Intelligent Flight Battery for five seconds. The aircraft front LEDs blink red and green alternately, indicating that the linking is in progress.
4. The Status LED on the remote controller glows solid green and the aircraft front LEDs blinks red several times if linking is successful. If linking fails, enter linking status again and retry.
5. Repeat Step 3 and 4 to complete linking between all the devices and the remote controller, if Multi Linking is selected. When finished, tap End Linking. Note that up to five devices can be linked.

DJI Agras App

DJI Agras is designed for agricultural applications. The app has a clear and concise interface and displays the status of the aircraft, spraying system, and other devices connected to the remote controller, and enables users to configure various settings. After planning a field via the intelligent operation planning system of the app, the aircraft can automatically follow the pre-planned flight route.

Home Screen

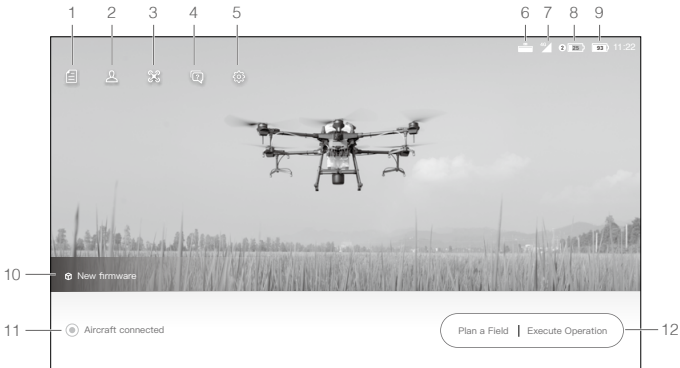

1. Task Management

: View planned fields and operation progress. You can synchronize the local data with the data on the DJI AG platform.

2. User Info

: View account information.

3. Aircraft Info

: View the information of the connected aircraft such as the firmware version.

4. Troubleshooting

: View solutions for errors of each module and upload error logs.

5. General Settings

: Tap for settings such as units of measurement, network diagnosis, and Android system settings.

6. Expansion Module Connection Status

: Shows if the remote controller expansion module (used to mount the 4G dongle) is connected.

7. 4G Dongle Signal Strength

: The icon is displayed if a 4G dongle is mounted. It shows the current signal strength of the 4G dongle.

8. External Battery Level

 : The icon is displayed if an external battery is mounted. It shows the current battery level of the external battery.

9. Internal Battery Level

 : Shows the current battery level of the internal battery.

10. Firmware Notifications

 : Shows the firmware update notifications. Tap to enter the firmware page.

11. Aircraft Connection Status

 : Shows if the aircraft is connected to the remote controller.

12. Plan a Field | Execute Operation

Plan a Field: Tap the button and select the planning method to plan a field.

Execute Operation: Tap to enter Operation View to view the aircraft status, configure settings, and switch between different operation modes.

Operation View

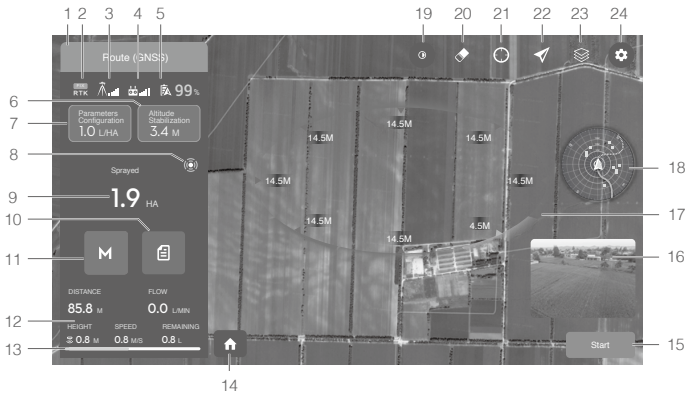

1. System Status

 : Indicates current flight modes, operation modes, and warning messages. Tap to enter Aircraft Health System to view and diagnose each module and upload status logs.

2. RTK/GNSS Signal Strength

 : This icon is displayed when RTK is enabled and works normally. On the upper right corner is the number of satellites connected. One of the following three statuses is displayed above the RTK icon: FIX indicates that the differential data calculation is completed and the aircraft can use RTK for positioning. The aircraft can only take off in this status. FLOAT indicates that the system is calculating the differential data. Wait for FIX to be displayed. SINGLE indicates that the differential data is not obtained. Wait for FIX to be displayed.

: This icon is displayed when RTK is not in use. It shows the current GNSS signal strength and the number of satellites connected.

3. RTK Connection Status

Icons displayed when using RTK data. The display varies when using the D-RTK 2 or Network RTK Service.

: Displays RTK signal strength when using the D-RTK 2.

: Indicates that the connection with the D-RTK 2 is abnormal. Refer to the prompts in the app.

: Displays RTK signal strength when using the Network RTK Service.

: Indicates that the connection with the Network RTK server is abnormal. Refer to the prompts in the app.

4. Control Signal Strength

: Shows the signal strength of the connection between the aircraft and the remote controller.

5. Battery Settings

 99%: Shows the current battery level. Tap to set the low battery warning threshold and view battery information.

6. Altitude Stabilization

When the altitude stabilization function of the radar module is enabled, this icon shows the preset height between the aircraft and the object underneath the aircraft. Tap the value to adjust.

7. Parameters Configuration

Shows the spray amount. Tap the value to enter the menu for operation parameters adjustment. The adjustable parameters vary according to the operation mode, including spray amount, flying speed, line spacing, height above the vegetation, and banked turning.

8. Radar Working Mode

Shows the current working mode of the radar module. Tap to select.

: Obstacle Avoidance Radar indicates that obstacle avoidance is enabled.

: Narrow Radar indicates that the radar detection angle is narrower than usual to allow flying close to the edges of fields. For example, when there are field boundaries such as fences or trees, enable Narrow Radar mode to make sure that the aircraft can fly closer to the edges and spray liquid on the vegetation near the edges.

: Disable Radar indicates that the obstacle avoidance function is disabled. This will not disable the altitude stabilization function of the radar module.

9. Area

Shows the area values related to the operation area, including the following values.

Field Area: Shows the total plan area value when planning fields for Route operations via the intelligent operation planning system.

Plan Area: Shows the value of the actual area of the planned flight route after planning fields. The area is planned using the following formula: Plan Area = Field Area - Obstacle Area - Safety Margin Zone.

Obstacle Area: Shows the area value of the obstacles measured when planning fields for Route operations.

Safety Margin Area: Shows the area of the safety margin zone if the safety margin is configured when planning fields for Route operations.

Sprayed Area: Shows the value of the area already sprayed.

10. Operation List

: Displayed in M operation mode. Tap to view the planned fields and operations in progress and invoke operations.

11. Operation Mode Switch Button

M / M⁺ / AB: Tap to switch between Manual (M), Manual Plus (M+), and A-B Route (AB) operation modes.

12. Flight Telemetry

Distance: Horizontal distance from the aircraft to the home point.

Flow: Pesticide flow rate.

Height: When the altitude stabilization function of the radar module is enabled, it shows the preset height between the aircraft and the object underneath the aircraft. Otherwise, it shows the height between the aircraft and the takeoff point.

Speed: The flying speed of the aircraft.

Remaining: The remaining amount of pesticide.

13. Liquid Level Notification

It shows a full green progress bar when the remaining liquid amount in the spray tank is sufficient. When the remaining liquid level nears the threshold of the empty tank warning, the green part of the progress bar will start to reduce gradually. It will turn gray when the remaining liquid level reaches the empty tank warning.

14. Home Screen

: Tap this icon to return to the home screen.

15. Operation Control Buttons

Used to control the aircraft during different operation types, including measuring an operation area and invoking, starting, pausing, or ending an operation.

16. FPV Camera View

Displays the real-time image from the FPV camera. Tap to switch between the Map View and the Camera View.

17. Obstacle Detection Status

Shows information on the detected obstacles when the obstacle avoidance function of the radar module is enabled. The information of obstacles in all horizontal directions will display on the screen in the shape of a circle. Red bars indicate obstacles nearby, while yellow bars indicate obstacles further away. The value indicates the distance between the aircraft and the nearest obstacle.

18. Obstacle Radar Map

During Route or A-B Route operations, the icon shows the nearby obstacles and planned flight route using the auto obstacle avoidance function, if obstacles are detected when auto obstacle avoidance is enabled.

19. FPV Mode Switch

Tap to switch the FPV display mode. If Night mode is selected, the image display will be brighter. If Day mode is selected, the image display will be normal.

20. Clear Screen

 : Tap to clear the flight route currently shown on the map.

21. Location

 : Tap to center the map around the location of the aircraft or the latest recorded home point.

22. Location Follow

Tap to choose if the map display follows the aircraft location.

 : To keep the aircraft centered in the map.

 : To keep the map display fixed regardless of the aircraft location.

23. Map Mode

 : Tap to switch between Standard, Satellite, or Night modes.

24. More Settings

Tap  to enter the extended menu to view and adjust the parameters of all other settings.

 : Aircraft Settings - Includes setting the action after completing spraying and completing operations, the aircraft behavior and whether to abort operation when the remote controller signal is lost, home point position, RTH altitude, lamp brightness, whether to lock the heading in Manual Plus operation mode, whether to enable Attitude mode, maximum altitude, and maximum flight distance limit, and advanced settings.

 : Spraying System Settings - Includes setting whether to display real-time data, to clear trapped air, setting spray tank level, empty tank warning threshold, whether to display pesticide placement point, and flow meter error alert, calibrating pump flow and flow meter, nozzle model, and to restore flow meter to factory settings.

 : RC Settings - Includes linking, linked aircraft, RC calibration, stick mode, RC custom key, and RC ID.

 : Radar Settings - Includes altitude stabilization, obstacle avoidance, narrow radar mode, spraying terrain (Flat and Mountain), and obstacle display mode.

RTK : RTK Settings - Includes aircraft RTK positioning, RTK signal source and the corresponding settings.

HD : Image Transfer Settings - Includes channel mode and sweep frequency chart selection.

 : Aircraft Battery - Includes low battery warning and battery information.

 : General Settings - Includes map settings, flight route display, and FPV settings.

Flight

Operation Environment

1. DO NOT use the aircraft to spray in winds exceeding 18 kph (11 mph).
2. DO NOT use the aircraft in adverse weather conditions such as snow, fog, winds exceeding 28 kph (17 mph), and heavy rain (precipitation rate exceeding 25 mm (0.98 in) in 12 hours).
3. Only fly in open areas. Tall buildings and steel structures may affect the accuracy of the compass and the GNSS signal.
4. Pay attention to utility poles, power lines, and other obstacles. DO NOT fly near or above water, people, or animals.
5. Maintain VLOS of the aircraft at all times, and avoid flying near obstacles, crowds, animals, and bodies of water.
6. Avoid flying in areas with high levels of electromagnetism, including mobile phone base stations and radio transmission towers.
7. The recommended maximum operating altitude is 2 km (6,560 ft) above sea level. DO NOT fly over 3 km (9,842 ft) above sea level.
8. Once the operating altitude reaches 1 km (3,280 ft), the payload capacity of the spray tank is reduced by 2 kg. For every additional km, the payload capacity will reduce by a further 2 kg.
9. Make sure that there is a strong GNSS signal and the D-RTK antennas are unobstructed during operation.
10. DO NOT operate the aircraft indoors.

Flight Limits and GEO Zones

Unmanned aerial vehicle (UAV) operators should abide by the regulations from self-regulatory organizations such as the International Civil Aviation Organization, the Federal Aviation Administration, and their local aviation authorities. For safety reasons, flight limits are enabled by default to help users operate this aircraft safely and legally. Users can set flight limits on height and distance.

When operating with a strong GNSS signal, the height and distance limits and GEO zones work together to monitor flight. With a weak GNSS signal, only the height limit prevents the aircraft from going above 30 meters.

Maximum Height and Radius Limits

Users can change the maximum height and radius limits in the app. Once completed, the aircraft flight is restricted to a cylindrical area that is determined by these settings. The tables below show the details of these limits.

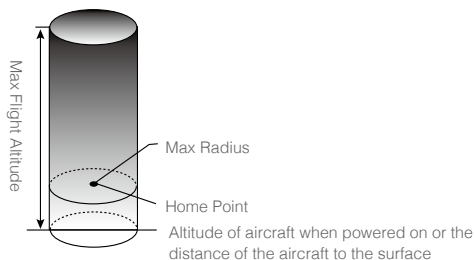

With a strong GNSS signal

Flight Limits

Max Height Flight altitude must be below the preset height.

Max Radius Flight distance must be within the max radius.

With a weak GNSS signal

Flight Limits

Max Height Flight altitude must be below the preset height.

Max Radius No limit.



- If the aircraft flies into a Restricted Zone, it can still be controlled, but the aircraft can only fly in a backward direction.
- If the aircraft loses GNSS signal and flies out of the max radius but regains GNSS signal later, it will fly back within range automatically.



GEO Zones

GEO zones are divided into different categories. All GEO zones are listed on the DJI official website at <http://www.dji.com/flysafe>.

GEO zones are explained below (GNSS required):

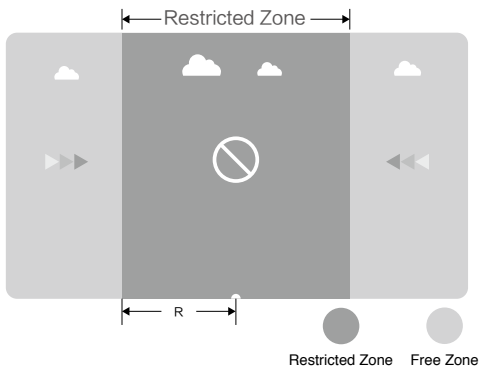
Depending on the local regulation, a certain radius around a marker forms a Restricted Zone, inside of which takeoff and flight are prohibited.



With a strong GNSS signal		
Area	Restriction	Aircraft Status Indicators
Restricted Zone 	Motors will not start.	Blink Red
	If the aircraft loses GNSS signal and enters a Restricted Zone but regains GNSS signal later, the aircraft will enter semi-automatic descent and land.	
No Flight Restrictions 	Users can fly their aircraft freely.	None.

 Semi-Automatic Descent: All stick commands except the throttle stick command are available during descent and landing. Motors automatically stop after landing.

-  • When operating in Restricted Zones, the aircraft status indicators blink red slowly and continue for five seconds, and then switch to the current aircraft status for twelve seconds. If the aircraft is still in the Restricted Zone at that point, it switches to blinking red slowly for five seconds again and so on.
- DO NOT fly near airports, highways, railway stations, railway lines, city centers, or other busy areas. Make sure the aircraft is visible at all times.

Pre-Flight Checklist

1. Make sure the remote controller and aircraft battery are fully charged. The pesticides required are adequate.
2. Make sure the spray tank and Intelligent Flight Battery are firmly in place.
3. Make sure all parts are mounted securely.
4. Make sure all cables are connected properly and firmly.
5. Make sure propellers are securely mounted, that there are no foreign objects in or on the motors and propellers, that the propeller blades and arms are unfolded, and the arm sleeves are firmly tightened.
6. Make sure the spraying system is not blocked in any way.
7. Make sure the sprinkler hoses are clear from bubbles. Discharge any bubbles as they may affect the performance of the sprinkler. Press and hold the spray button for two seconds to start the automatic bubbles discharge function to spray the bubbles.



Calibrating the Spraying System



Make sure to calibrate the flow meter before your first operation. Otherwise, the spraying performance may be adversely affected.

1. Preparation before calibration: Discharging the bubbles in the hoses
 - ① Fill the spray tank with approximately 2 L of water.
 - ② Use the automatic bubbles discharge function to discharge the bubbles according to the descriptions in the Discharging the Bubbles in the Hoses section below. Users can also manually



discharge the bubbles. Press the spray button to spray the bubbles and press the button again once all bubbles are discharged.

2. Flow Meter Calibration

- ① In the app, tap Execute Operation to enter Operation View. Tap , then , and tap Calibration on the right of the flow meter section.
- ② Calibration starts automatically. After 25 seconds, the result of the calibration is displayed in the app.
 - After calibrating successfully, users can proceed with the operation.
 - If calibration fails, tap “?” to view and resolve the problem. Afterward, recalibrate.



 During calibration, tap , then  to cancel. If the calibration is cancelled, the accuracy of the flow meter is based on the data before the calibration was started.

When to Recalibrate

1. Installing a different nozzle model. Note: Choose the corresponding model in the app after replacing nozzles. Go to Operation View, tap , then  for configuration.
2. Using a liquid of a different viscosity.
3. The error between the actual value and the theoretical value of the completed area is more than 15%.

Discharging the Bubbles in the Hoses



The T20 features an automatic bubbles discharge function. When it is necessary to discharge bubbles, start the function through one of the two methods below. The aircraft will discharge automatically until the bubbles are fully discharged.

1. Press and hold the spray button for two seconds.
2. Enter Operation View, tap , then , and tap Start on the right of the Clear Trapped Air section.

Calibrating the Compass

-  • It is important to calibrate the compass. The calibration result affects the flight safety. The aircraft may malfunction if the compass is not calibrated.
- DO NOT calibrate the compass where there is a chance of strong magnetic interference. This includes areas where there are utility poles or walls with steel reinforcements.
 - DO NOT carry ferromagnetic materials with you during calibration such as keys or mobile phones.
 - If the aircraft status indicators show a blinking red light, compass calibration has failed. Please recalibrate.
 - After calibrating successfully, the compass may be abnormal when you place the aircraft on the ground. This may be because of underground magnetic interference underground. Move the aircraft to another location and try again.

Calibrate the compass when prompted by the app. It is recommended to calibrate the compass with an empty tank

1. Tap , then , move the slider to the bottom, and select Advanced Settings, then IMU and Compass Calibration. Tap Calibration in the compass calibration section.
2. Hold the aircraft horizontally and rotate it 360° around a vertical axis with the aircraft approximately 1.2 m above the ground. Calibration is completed when the app displays that calibration was successful.

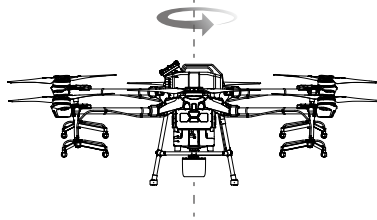

3. If the app displays a tilted aircraft, it indicates that the horizontal calibration failed. Users should tilt the aircraft and rotate it horizontally. Calibration is completed when the app displays that calibration was successful. To reduce the number of rotations required, the aircraft should be tilted at least 45°.

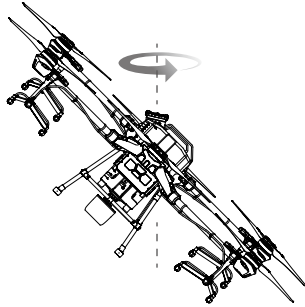

4. If calibration continues to fail, recalibrate the compass from Step 1.

Starting and Stopping the Motors

Starting the Motors

The Combination Stick Command (CSC) listed below is used to start and stop the motors. Make sure you perform the CSC in one continuous motion. The motors begin to accelerate at an idle speed. Release both sticks simultaneously. Take off immediately once the motors are spinning, or else the aircraft may lose balance, drift, or even takeoff by itself and risk causing damage or injury.



Stopping the Motors

There are two methods to stop the motors.

1. When the aircraft has landed, push and hold the throttle stick down. The motors will stop after three seconds.



Throttle Stick (left stick in Mode 2)

2. When the aircraft has landed, push the throttle stick down, and perform the same CSC that was used to start the motors. Release both sticks once the motors have stopped. Release both sticks once the motors have stopped.

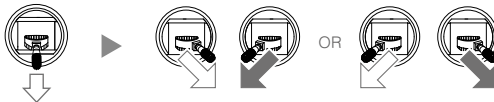



Throttle Stick

-
- ⚠ • Spinning propellers can be dangerous. Stay away from spinning propellers and motors. DO NOT start the motors in confined spaces or when there are people nearby.
 - Keep your hands on the remote controller when the motors are spinning.
 - DO NOT stop the motors mid-flight unless in an emergency situation where doing so will reduce the risk of damage or injury.
 - Method 1 is the recommended method for stopping the motors. When using Method 2 to stop the motors, the aircraft may roll over if it is not completely grounded. Use Method 2 with caution.
 - After landing, power off the aircraft before powering off the remote controller.
-

Flight Test

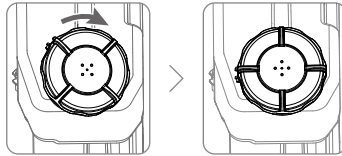
1. Place the aircraft on open, flat ground with the aircraft status indicators facing toward you.
2. Pour liquid into the spray tank, and tighten the cover. Make sure that the four lines on the cover are aligned to the horizontal or vertical direction.



3. Power on the remote controller, make sure that DJI Agram is open, and then power on the aircraft.
4. Make sure that the aircraft is connected to the remote controller.
5. If using RTK for positioning, make sure that the aircraft RTK positioning function is enabled and RTK signal source is correctly set (D-RTK 2 Mobile Station or Network RTK service). Go to Operation View in the app, tap  and select RTK to view and set.

Make sure to disable the aircraft RTK positioning function if it is not in use. Otherwise, the aircraft is not be able to take off when there is no differential data.

6. Wait for satellites to be searched, make sure that there is a strong GNSS signal, and make sure the aircraft heading measurement using the dual antennas is ready. Perform the CSC to start the motors. (If the dual antennas are not ready after waiting for an extended period, move the aircraft to an open area with a strong GNSS signal.)
7. Push the throttle stick up to take off.
8. Select the desired operation or flight mode and start operation.
9. Exit the operation to manually control the aircraft for landing. Hover over a level surface and gently pull down on the throttle stick to slowly descend.
10. After landing, push the throttle down and hold. The motors stop after three seconds.
11. Power off the aircraft, and then power off the remote controller.



- When the aircraft status indicators rapidly blink yellow during flight, the aircraft has entered Failsafe mode.
- The low battery level warning is triggered when the aircraft status indicators slowly blink red. Fly the aircraft to a safe area and land as soon as possible, stop the motors, and replace the battery. The critical low battery level warning is triggered when the aircraft status indicators rapidly blink red. The aircraft will begin to automatically descend and land.

DJI Assistant 2 for MG

Configure settings of the basic parameters, copy flight records, and update aircraft and remote controller firmware in DJI Assistant 2 for MG.

Installation and Launching

1. Download the DJI Assistant 2 for MG installation file from the T20 download page:
<http://www.dji.com/t20/info#downloads>
2. Install the software.
3. Launch DJI Assistant 2 for MG.

Using DJI Assistant 2 for MG

Connecting the Aircraft

Connect the USB-C port on the bottom of the aerial-electronics system of the aircraft to a computer with a USB-C cable, and then power on the aircraft.



Make sure to remove the propellers before using DJI Assistant 2 for MG.



Remove the waterproof cover on the USB-C port before use. Attach the waterproof cover to the port after use. Otherwise, water may enter the port, causing it to short circuit.

Firmware Update

A DJI account is required for firmware updates. Login or register an account.

Basic Settings

Configure the idle speed of and test the motor.

Tools

Enter SD card mode and copy the flight record.

Connecting the Remote Controller

1. Connect the USB-C port of the remote controller to a computer with a USB A to A cable, and then power on the remote controller.
2. Swipe from the top of the screen, and make sure that the USB option is enabled.

Firmware Update

A DJI account is required for firmware updates. Login or register an account.



- DO NOT power off the remote controller during the update.
 - DO NOT perform the firmware update while the aircraft is in the air. Only carry out the firmware update when the aircraft is on the ground.
 - The remote controller may become unlinked from the aircraft after the firmware update. Relink the remote controller and aircraft if necessary.
-

Data Copy

To copy data, access the internal storage of the remote controller and the inserted microSD card through the computer.

Appendix

Specifications

Product Model	3WWDZ-15.1B
Airframe	
Max Diagonal Wheelbase	1883 mm
Dimensions	2509×2213×732 mm (Arms and propellers unfolded) 1795×1510×732 mm (Arms unfolded and propellers folded) 1100×570×732 mm (Arms and propellers folded)
Propulsion System	
Motors	
Stator Size	100×15 mm
KV	75 rpm/V
Max Thrust	13.5 kg/rotor
Max Power	2400 W/rotor
Weight	666 g
ESCs	
Max Working Current (Continuous)	40 A
Max Working Voltage	58.8 V (14S LiPo)
Foldable Propellers (R3390)	
Diameter × Pitch	33×9 in
Weight (Single propeller)	90 g
Spraying System	
Spray Tank	
Volume	Full: 20 L
Operating Payload	Full: 20 kg
Nozzles	
Model	XR11001VS (Standard); XR110015VS, XR11002VS (Optional, purchase separately)
Quantity	8
Max Spray Rate	XR11001VS: 3.6 L/min, XR110015VS: 4.8 L/min, XR11002VS: 6 L/min
Spray Width	4 - 7 m (8 nozzles, at a height of 2 - 3 m above crops)
Droplet Size	XR11001VS: 130 - 250 μm, XR110015VS: 170 - 265 μm, XR11002VS: 190 - 300 μm (Subject to operating environment and spray rate)
Flow Meter	
Measurement Range	0.25 - 20 L/min
Error	< ±2%
Measurable Liquid	Conductivity > 50 μS/cm (Liquids such as tap water or pesticides that contain water)

Omnidirectional Digital Radar

Model	RD2428R
Operating Frequency	CE / FCC / NCC: 24.05 - 24.25 GHz MIC / KCC: 24.05 - 24.25 GHz
Transmitter Power (EIRP)	MIC / KCC / CE / FCC / NCC: < 20 dBm
Power Consumption	18 W
Altitude Detection & Terrain Follow ^[1]	Altitude detection range: 1 - 30 m Stabilization working range: 1.5 - 15 m Max slope in Mountain mode: 35°
Obstacle Avoidance System ^[1]	Obstacle sensing range: 1.5 - 30 m FOV: Horizontal: 360°, Vertical: ±15° Working conditions: Flying higher than 1.5 m over the surface below at a speed lower than 7 m/s Safety distance: 2.5 m (Distance between the front of propellers and the obstacle after braking) Obstacle avoidance direction: Omnidirectional obstacle avoidance in the horizontal direction
IP Rating	IP67

FPV Camera

FOV	Horizontal: 98°, Vertical: 78°
Resolution	1280×960 30fps
FPV Spotlight	FOV: 110°, Max brightness: 12 lux at 5 m of direct light

Flight Parameters

OcuSync 2.0 Operating Frequency ^[2]	CE / MIC / KCC / FCC / NCC / SRRC: 2.4000 - 2.4835 GHz FCC / NCC / SRRC: 5.725 - 5.850 GHz
OcuSync 2.0 Transmitter Power (EIRP)	2.4 GHz SRRC / CE / MIC / KCC: 18.5 dBm, FCC / NCC: 25.5 dBm 5.8 GHz SRRC / FCC / NCC: 25.5 dBm
Total Weight (Excluding battery)	21.1 kg
Max Takeoff Weight	47.5 kg (At sea level)
Max Thrust-Weight Ratio	1.70 (Takeoff weight of 47.5 kg)
Hovering Accuracy Range (With strong GNSS signal)	D-RTK enabled: Horizontal: ±10 cm, Vertical: ±10 cm D-RTK disabled: Horizontal: ±0.6 m, Vertical: ±0.3 m (Radar module enabled: ±0.1 m)
RTK / GNSS Operating Frequency	RTK: GPS L1/L2, GLONASS F1/F2, BeiDou B1/B2, Galileo E1/E5 ^[3] GNSS: GPS L1, GLONASS F1, Galileo E1 ^[3]
Battery	DJI-approved flight battery (AB3-18000mAh-51.8V)
Max Power Consumption	8300 W
Hovering Power Consumption	6200 W (Takeoff weight of 47.5 kg)
Hovering Time ^[4]	15 min (Takeoff weight of 27.5 kg with an 18000 mAh battery) 10 min (Takeoff weight of 47.5 kg with an 18000 mAh battery)
Max Tilt Angle	15°
Max Operating Speed	7 m/s

Max Flying Speed	10 m/s (With a strong GNSS signal)
Max Wind Resistance	8 m/s
Max Service Ceiling Above Sea Level	2000 m
Recommended Operating Temperature	0° to 40° C (32° to 104° F)
Remte Controller	
Model	RM500-AG
Screen	5.5-inch screen, 1920x1080, 1000 cd/m ² , Android system
RAM	4 GB LPDDR4
ROM	32 GB + scalable storage; microSD cards supported; Max Capacity: 128 GB. UHS-I Speed Grade 3 rating required
Built-in Battery	18650 Li-ion (5000 mAh @ 7.2 V)
GNSS	GPS+GLONASS
Power Consumption	18 W
Operating Temperature	-10° to 40° C (14° to 104° F)
Charging Temperature	5° to 40° C (40° to 104° F)
Storage Temperature	-30° to 25° C (-22° to 77° F)
OcuSync 2.0	
Operating Frequency ²⁾	CE / MIC / KCC / FCC / NCC / SRRC: 2.4000 - 2.4835 GHz FCC / NCC / SRRC: 5.725 - 5.850 GHz
Max Transmission Distance	FCC / NCC: 5 km, SRRC / MIC / KCC / CE: 3 km (Unobstructed, free of interference)
Transmitter Power (EIRP)	2.4 GHz SRRC / CE / MIC / KCC: 18.5 dBm, FCC / NCC: 25.5 dBm 5.8 GHz SRRC / FCC / NCC: 25.5 dBm
Wi-Fi	
Protocol	Wi-Fi Direct, Wi-Fi Display, 802.11a/g/n/ac Wi-Fi with 2x2 MIMO is supported
Operating Frequency ²⁾	2.4000 - 2.4835 GHz 5.150 - 5.250 GHz 5.725 - 5.850 GHz
Transmitter Power (EIRP)	2.4 GHz SRRC / CE: 18.5 dBm, FCC / NCC / MIC / KCC: 20.5 dBm 5.2 GHz SRRC / FCC / NCC / CE / MIC: 14 dBm, KCC: 10 dBm 5.8 GHz SRRC / FCC / NCC: 18 dBm, CE / KCC: 12 dBm
Bluetooth	
Protocol	Bluetooth 4.2
Operating Frequency	2.4000 - 2.4835 GHz
Transmitter Power (EIRP)	SRRC / FCC / NCC / CE / MIC / KCC: 6.5 dBm

Remote Controller Intelligent Battery

Model	WB37-4920mAh-7.6V
Battery Type	2S LiPo
Capacity	4920 mAh
Voltage	7.6 V
Energy	37.39 Wh
Charging Temperature	5° to 40° C (40° to 104° F)

Intelligent Battery Charging Hub















Model	WCH2
Input Voltage	17.3 - 26.2 V
Output Voltage and Current	8.7 V, 6 A
Operating Temperature	5° to 40° C (40° to 104° F)

AC Power Adapter

Model	A14-057N1A
Input Voltage	100 - 240 V, 50/60 Hz
Output Voltage	17.4 V
Rated Power	57 W

- [1] The effective radar range varies depending on the material, position, shape, and other properties of the obstacle.
- [2] Local regulations in some countries prohibit the use of the 5.8 GHz and 5.2 GHz frequencies. In some countries, the 5.2 GHz frequency band is only allowed for indoor use.
- [3] Support for Galileo will be available at a later date.
- [4] Hovering time acquired at sea level with wind speeds lower than 3 m/s.

Aircraft Status Indicators Description

Blinking Patterns	Description
 Blink red, green, and yellow	Self-checking
 ×4 Blink yellow four times	Warning up
 Blink yellow slowly	A-mode (no GNSS)
 Blink green slowly	P-mode (GNSS)
 Blink green rapidly	When an obstacle is detected, the aircraft breaks and hovers to enter obstacle avoidance mode.
 Blink yellow and green alternately	RTK dual antenna is not ready.
 Blink red and green alternately	RTK function is enabled, but RTK positioning is not ready.
 — Solid red	System error. Restart the aircraft, and if still not working, contact DJI Support or a DJI authorized dealer.
 Blink red and yellow alternately	Abnormal compass data. Compass calibration required.
 Blink red rapidly several times	Point A recorded.
 Blink green rapidly several times	Point B recorded.
 Blink yellow rapidly	Remote controller signal lost.
 Blink red slowly	Low battery level.
 Blink red rapidly	Critical low battery level or battery voltage.

Updating the Firmware

Users can update the firmware of both the aircraft and remote controller in DJI Agras.

1. Power on the remote controller and the aircraft. Make sure that the remote controller has access to the internet via Wi-Fi or a dongle. The firmware file is usually large. It is recommended to use Wi-Fi.
2. A prompt appears in the lower right corner of the screen in DJI Agras when a new firmware update is available. Tap the prompt to enter the firmware screen.
3. Select the desired firmware and tap Update to enter firmware update page.
4. For remote controller firmware, tap Go to Update to redirect to the system settings page, and follow the instructions for update.

For firmware of devices such as the aircraft or D-RTK 2 mobile station, the firmware will be transmitted from the remote controller to the corresponding device through OcuSync. Make sure the device and remote controller are properly connected. Tap Download XXX (XXX indicates the firmware version) to download the firmware package for all the devices.

5. When the download is complete, tap Update XXX under each device to enter the update page for the corresponding device. Tap Install and wait for the update to complete.
7. After successfully completing the update, restart the remote controller and the aircraft manually.

DJI Assistant 2 for MG can also be used to update the firmware. Refer to [DJI Assistant 2 for MG \(p. 51\)](#) for more information.

DJI Support

<http://www.dji.com/support>

This content is subject to change without prior notice.

Download the latest version from

<http://www.dji.com/t20>

If you have any questions about this document, contact DJI by sending a message to DocSupport@dji.com.

Copyright © 2020 DJI All Rights Reserved.