

AGRAS T30

User Manual

v1.4

2021.07

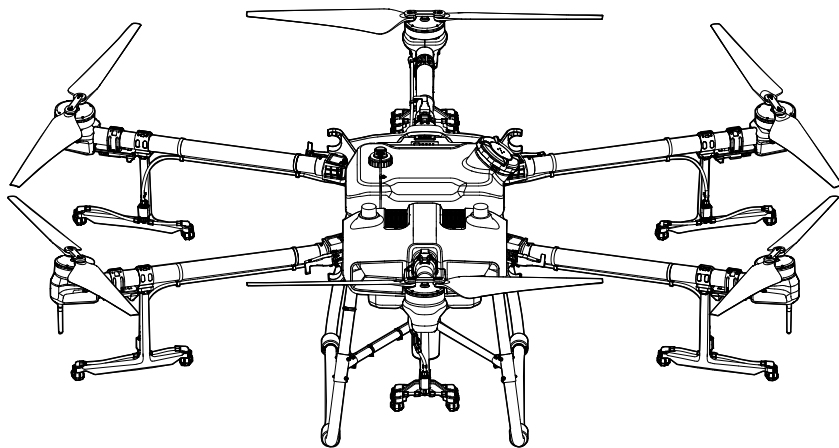

Searching for Keywords

Search for keywords such as “battery” and “install” to find a topic. If you are using Adobe Acrobat Reader to read this document, press Ctrl+F on Windows or Command+F on Mac to begin a search.

Navigating to a Topic

View a complete list of topics in the table of contents. Click on a topic to navigate to that section.

Printing this Document

This document supports high resolution printing.

Information

The AGRAS™ T30 may not come with a flight battery in certain regions. Only purchase official DJI™ flight batteries. Read the corresponding Intelligent Flight Battery user guide and take necessary precautions when handling the batteries to ensure your own safety. DJI assumes no liability for damage or injury incurred directly or indirectly from misusing batteries.

Using This Manual

Legend

 Important

 Hints and tips

 Reference

Before Flight

The following documents have been produced to help you safely operate and make full use of your aircraft:

1. In the Box
2. Disclaimer and Safety Guidelines
3. Quick Start Guide
4. User Manual

Refer to the Agras T30 In the Box to check the listed parts and read the disclaimer and safety guidelines before flight. Refer to the quick start guide for more information on assembly and basic operation. Refer to the user manual for more comprehensive information.

Downloading DJI Assistant 2 for MG

Download DJI ASSISTANT™ 2 for MG from:
<https://www.dji.com/t30/downloads>

 The operating temperature of this product is 0° to 45° C (32° to 113° F). It does not meet the standard operating temperature for military grade application (-55° to 125° C (-67° to 257° F)), which is required to endure greater environmental variability. Operate the product appropriately and only for applications that it meets the operating temperature range requirements of that grade.

Safety at a Glance

1. Pesticide Usage

- **Avoid** the use of **powder pesticides** as much as possible as they may reduce the service life of the spraying system.
- **Pesticides are poisonous and pose serious risks to safety. Only use them in strict accordance with their specifications.**
- Residue on the equipment caused by splashes or spills **when pouring and mixing the pesticide can irritate your skin.** Make sure to clean the equipment after mixing.
- Use **clean water** to mix the pesticide and filter the mixed liquid before pouring into the spray tank to **avoid blocking** the strainer. **Clear any blockage** before using the equipment.
- Make sure to **stay in an upwind area** when spraying pesticide to avoid bodily harm.
- **Wear protective clothing** to prevent direct body contact with the pesticide. **Rinse your hands and skin** after handling pesticides. **Clean the aircraft and remote controller** after applying the pesticide.
- Effective use of pesticides depends on **pesticide density, spray rate, spray distance, aircraft speed, wind speed, wind direction, temperature, and humidity.** Consider all factors when using pesticides, but DO NOT compromise the safety of people, animals, or the environment in doing so.
- **DO NOT contaminate** rivers and sources of drinking water.
- Disposal of surplus spray: Planning the spray operation helps to ensure only enough pesticide for the area to be treated is purchased and the amount of surplus spray solution is kept to a minimum. It is recommended that any surplus spray or washing liquid in the tank be applied to the crops. Users may also consider installing a pipeline to handle the disposal of the washing liquid in the tank.
- DO NOT use strong acids, strong bases, high-temperature liquids, or pesticides that are explicitly prohibited.



The Agras T30 aircraft is not a toy and is not suitable for children under the age of 18.

Note that the Safety at a Glance section only provides a quick overview of the safety tips. Make sure you read and understand the Agras T30/T10 Disclaimer and Safety Guidelines and this user manual.

2. Environmental Considerations

- Fly at locations that are **clear of buildings and other obstacles. DO NOT fly above or near large crowds.**
- DO NOT fly over **4.5 km (14,763 ft) above sea level.**
- Only fly in moderate weather conditions with temperatures **between 0° and 45° C (32° and 113° F).**
- Make sure that your operations do not violate any applicable laws or regulations, and that you have obtained all appropriate prior authorizations. Consult the relevant government agency or authority, or your lawyer before flight to ensure you comply with all relevant laws and regulations.
- **DO NOT operate any part of the aircraft indoors.**

3. Pre-Flight Checklist

Make sure to check all of the following:

- Remote controller and aircraft batteries are **fully charged.**
- All parts are **in good condition.** Replace aged or broken parts before flight.
- **Landing gear and spray tank** are firmly in place.
- **Propellers and frame arms are unfolded and arm locks are firmly tightened.** Propellers are in **good condition and firmly tightened.** There is **nothing obstructing the motors and propellers.**
- There is nothing obstructing the position on the aircraft shell where the upward radar is located underneath.
- **Spraying system is not blocked** and works properly.
- **Compass is calibrated** after being prompted to do so in the app.

4. Ingress Protection Rating Description

When functioning normally, the aircraft is waterproof, dustproof, and corrosion resistant. Under stable laboratory conditions, the aircraft (Intelligent Flight Battery excluded) has a protection rating of IP67 (IEC 60529) and can be cleaned using a small amount of water. However, this protection rating is not permanent and may reduce over time after long-term use due to aging and wear. The product warranty does not cover water damage.

The protection ratings of the aircraft mentioned above may decrease in the following scenarios:

- There is a collision and the seal structure is deformed.
- The seal structure of the shell is cracked or damaged.
- The waterproof covers are not properly secured.

5. Operation

- **Stay away** from the **rotating** propellers and motors.
- Make sure to fly **within the specified max takeoff weight** to avoid potential safety risks.
- The DJI Agras app will intelligently recommend the payload weight limit for the tank according to the current status and surroundings of the aircraft. **Do not exceed the recommended payload weight limit** when adding material to the tank. Otherwise, the flight safety may be affected.
- Maintain a visual line of sight (VLOS) of your aircraft at all times.
- DO NOT use the Combination Stick Command (CSC) or other methods to **stop the motors** when the aircraft is airborne unless in an emergency situation.
- DO NOT answer incoming calls during flight. DO NOT fly under the influence of **alcohol or drugs**.
- If there is a **low battery warning**, **land the aircraft at a safe location**.
- **If the radar module is unable to work properly in the operating environment**, the aircraft will be **unable to avoid obstacles during Return to Home (RTH)**. All that can be adjusted is the **flight speed and altitude**, as long as the remote controller is still connected.
- After landing, stop the motors, **power off the aircraft, and turn off the remote controller**. Otherwise, the aircraft may enter Failsafe RTH automatically due to remote controller signal loss.
- **Maintain full control of the aircraft at all times and do not rely on the DJI Agras app**. The obstacle avoidance function is disabled in certain situations. Keep the aircraft within VLOS and pay close attention to its flight. Use your discretion to operate the aircraft and manually avoid obstacles in a timely manner. It is important to set an appropriate Failsafe and RTH altitude before each flight.

6. Maintenance and Upkeep

- DO NOT use aged, chipped, or broken propellers.
- To avoid damaging the landing gear, **remove or empty the spray tank** during transportation or when not in use.
- Recommended storage temperature (when the spray tank, flow meter, pumps, and hoses are empty): **between -20° and 40° C (-4° and 104° F)**.
- Clean the aircraft immediately after spraying. Inspect the aircraft regularly. Refer to Product Care in the disclaimer and safety guidelines for more information about maintenance guidelines.

7. Observe Local Laws and Regulations

- You can find a list of DJI™ GEO zones at <http://www.dji.com/flysafe>. Note that the DJI GEO zones are not a replacement for local government regulations or good judgment.
- **Avoid flying at altitudes above 100 m (328 ft).***

* The flying altitude limit varies in different countries or regions. Make sure to fly at the altitudes outlined by local laws and regulations.



Fly in Open Areas

+

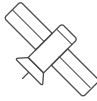

Strong GNSS Signal

+



VLOS

+

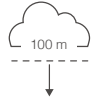

Fly Below 100 m (328 ft)

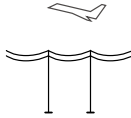

Avoid flying over or near crowds, high voltage power lines, or bodies of water. Strong electromagnetic sources such as **power lines, base stations, and tall buildings** may affect the onboard compass.



DO NOT use the aircraft in adverse weather conditions such as winds exceeding 28 kph (17 mph), heavy rain (precipitation rate exceeding 25 mm (0.98 in) in 12 hours), fog, snow, lightning, tornadoes, or hurricanes.

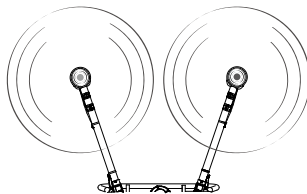
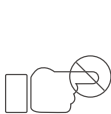

Stay away from rotating propellers and motors.



GEO Zones

Learn more at:
<http://www.dji.com/flysafe>

Contents

Information	1
Using This Manual	1
Legend	1
Before Flight	1
Downloading DJI Assistant 2 for MG	1
Safety at a Glance	2
Contents	5
Product Profile	7
Introduction	7
Feature Highlights	7
Preparing the Aircraft	8
Preparing the Remote Controller	9
Aircraft Overview	11
Remote Controller Overview	12
Aircraft	14
Aircraft Profile	14
Flight Modes	14
Operation Modes	14
Operation Resumption	22
System Data Protection	24
Spherical Radar System	24
Empty Tank Warning and Smart Supply Reminder	27
Orchard Configuration	27
Return to Home (RTH)	28
Low Battery and Low Voltage Warnings	30
RTK Functions	30
Aircraft LEDs	31

Remote Controller	32
Profile	32
Using the Remote Controller	32
Remote Controller LEDs	39
Remote Controller Warning Sounds	40
Linking the Remote Controller	40
Multi-Aircraft Control Mode	41
DJI Agras App	43
Home Screen	43
Operation View	44
Flight	48
Operation Environment	48
Flight Limits and GEO Zones	48
Pre-Flight Checklist	50
Discharging Trapped Air in the Hoses	50
Calibrating the Flow Meter	51
Calibrating the Compass	51
Starting and Stopping the Motors	52
Flight Test	53
DJI Assistant 2 for MG	55
Installation and Launching	55
Using DJI Assistant 2 for MG	55
Appendix	56
Specifications	56
Aircraft Status Indicators Description	60
Updating the Firmware	60

Product Profile

Introduction

The Agras T30 is DJI's next-generation aircraft, boasting a revolutionary transforming structure and a max payload of up to 40 kg. Using DJI's digital agriculture solutions, the performance and efficiency of crop protection operations can be greatly enhanced and improved. The updated Route Operation mode includes Connection Routing, which enables the aircraft to automatically fly to a task route and avoid obstacles that have been marked in field planning. The new Smart Supply Reminder calculates the remaining liquid amount to help users manage spraying operations.

The aircraft comes equipped with the Spherical Radar System, a pioneering new system for the agriculture industry. Consisting of the Omnidirectional Digital Radar and Upward Radar, the system provides functions such as terrain following, obstacle sensing, and obstacle circumventing. With the forward and backward FPV cameras and bright spotlights, the system comprehensively ensures operational safety day and night in different weather.

Thanks to the innovative new plunger pumps and the 16 sprinklers, the spraying system offers improved spray width, rate, distribution, and efficiency. The 2-channel electromagnetic flow meter and continuous liquid level gauge make measurements more accurate than ever. To spray orchards, users can purchase the optional orchard spray package to transform the aircraft into Orchard Configuration. When spraying orchards, branch-targeting technology can be used for precise spraying with the help of the all-new Spherical Radar System and DJI Agras Cloud.

The aircraft has a protection rating of IP67 (IEC 60529) and the core components boast three layers of protection, making the T30 corrosion-resistant, dustproof, and waterproof so that it can be washed directly with water.

The Smart Controller Enterprise uses DJI OCUSYNC™ Enterprise transmission technology, has a max transmission distance of up to 7 km^[1], and supports Wi-Fi and Bluetooth. The remote controller has a 5.5-inch bright, dedicated screen and comes with the updated DJI Agras app built-in, delivering a smooth and easy-to-use experience. Operations can be planned to centimeter-level precision when the RTK dongle is connected to the remote controller. The Multi-Aircraft Control mode^[2] of the remote controller can be used to coordinate the operation of multiple aircraft at the same time, enabling pilots to work efficiently. Both the built-in battery and external battery can be used to supply power to the remote controller. The remote controller has a working time of up to 4 hours, making it ideal for long and high-intensity operations.

Feature Highlights

The T30 features a brand-new quadrilateral folding structure design for quick folding and easy storage. Folding detection sensors built into the frame arms enable the aircraft to perform a folding mechanism self-check ensuring the arms are properly unfolded. The aircraft supports centimeter-level positioning^[3] when used with the onboard D-RTK™ while the dual-antenna technology provides strong resistance against magnetic interference. Users have clear views of the front and rear of the aircraft thanks to the dual FPV cameras.

[1] The remote controller is able to reach its maximum transmission distance (FCC/NCC: 7 km (4.35 mi); SRRC: 5 km (3.11 mi); CE/KCC/MIC: 4 km (2.49 mi)) in an open area with no electromagnetic interference, and at an altitude of approximately 2.5 m (8.2 ft).

[2] Make sure to comply with local laws and regulations when using Multi-Aircraft Control mode.

[3] Must be used with a DJI D-RTK 2 High Precision GNSS Mobile Station (sold separately) or a DJI-approved Network RTK service.

The updated Route operation mode includes Connection Routing. In Connection Routing, the aircraft will automatically return to a task route. Users can mark obstacles outside the task area during field planning for the aircraft to avoid and also add connection points for the aircraft to travel through along the connection route back to the task route. Operations are further automated by the Smart Supply Reminder, which calculates the remaining liquid amount in real time and displays the refill point on the map.

The crosshair can be used to add boundary and obstacle points in field planning, making operations easier than ever for users. The aircraft can perform variable rate fertilization by importing prescription maps to the remote controller and applying them to fields.

The Spherical Radar System consists of the Omnidirectional Digital Radar and Upward Radar, providing altitude detection and stabilization in forward, backward, and downward directions as well as obstacle sensing in all horizontal directions and upward direction when in Route, A-B Route, and Manual Plus operation modes. The radar can detect the angle of a slope and automatically adjust to maintain the same distance with the surface even in mountainous terrain. In Route and A-B Route operation modes, the radar can effectively sense obstacles and plan a route to actively circumvent obstacles. Obstacle circumvention is disabled by default and must be enabled in the app.

The spraying system is equipped with plunger pumps and a continuous liquid level gauge to offer even and accurate spraying. DJI provides an optional T30 Orchard Spray Package, which enables users to change the T30 to the Orchard configuration. When using the package and DJI's unique branch-targeting technology, the T30 can penetrate thick canopies for more precise and efficient spraying operations.

Multi-Aircraft Control mode enables users to coordinate the operation of multiple aircraft simultaneously with one remote controller. Users can switch between different aircraft in the app.

Preparing the Aircraft

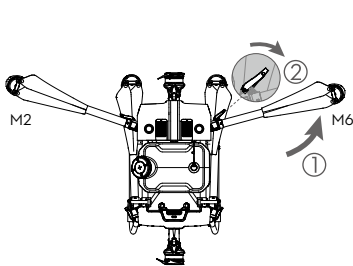

Unfold the M2 and M6 arms, and fasten the two arm locks. Avoid pinching fingers.

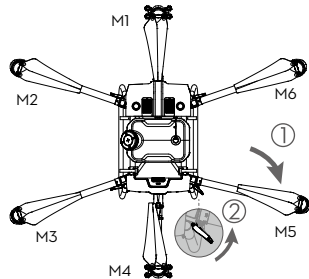

Unfold the M3 and M5 arms followed by M1 and M4 and fasten the four arm locks. Avoid pinching fingers.

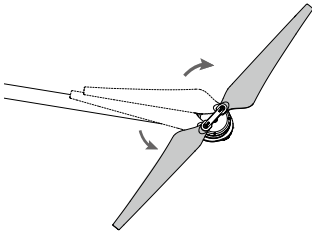

Unfold the propeller blades.

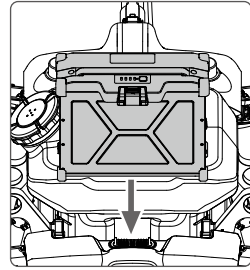

Insert the Intelligent Flight Battery into the aircraft until you hear a click.

-
- ⚠ • Make sure that the battery is firmly inserted into the aircraft. Only insert or remove the battery when the aircraft is powered off.
 - To remove the battery, press and hold the clamp and lift the battery up.
 - Fold the M3 and M5 arms followed by the M2 and M6 arms and make sure that the arms are inserted into the storage clamps on both sides of the aircraft. Otherwise, the arms may be damaged. Lift and lower the M1 and M4 arms gently to reduce wear and tear.
-

Preparing the Remote Controller

Mounting the External Battery

- ① Press the battery cover release button on the back of the remote controller down to open the cover.
- ② Insert the Intelligent Battery into the compartment and push it to the top.
- ③ Close the cover.

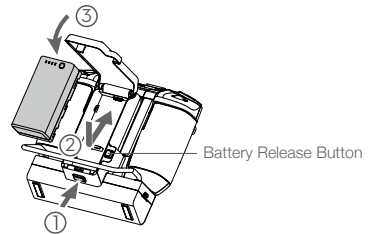

-
- ☀ To remove the Intelligent Battery, press and hold the battery release button and push the battery downward.
-

Mounting the 4G Dongle and SIM Card

- ⚠️ Only use a DJI-approved dongle. The dongle supports various network standards. Use a SIM card that is compatible with the chosen mobile network provider and select a mobile data plan according to the planned level of usage.
- The dongle and SIM card enable the remote controller to access specific networks and platforms such as the DJI Agram Management Platform. Make sure to insert them correctly. Otherwise, network access will not be available.

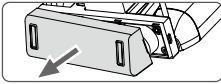

Remove the dongle compartment cover.

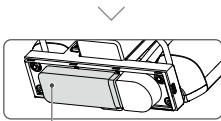

Make sure the SIM card is inserted into the dongle. Insert the dongle into the USB port and test the dongle.*

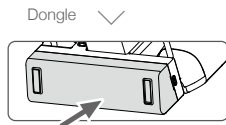

Reattach the cover firmly.

* Test procedure: press the remote controller power button and press again and hold to power on the remote controller. In DJI Agram, tap , and select Network Diagnostics. The dongle and SIM card are functioning properly if the status of all the devices in the network chain are shown in green.

Mounting the RTK Dongle

When using the RTK planning method to plan the task area, attach the RTK dongle to the USB-A port on the remote controller.

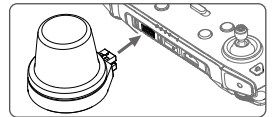

Adjusting the Antennas

Lift and adjust the antennas. The strength of the remote controller signal is affected by the position of the antennas. For an optimal connection between the remote controller and aircraft, make sure the angle between the antennas and the back of the remote controller is 80° or 180°.

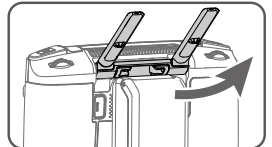

Aircraft Overview

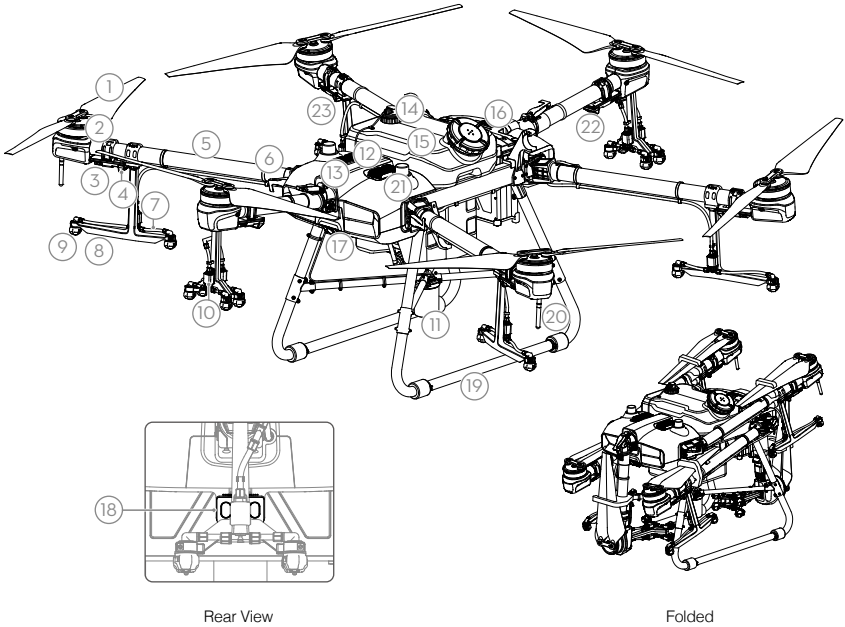

Rear View

Folded

- | | |
|---|---|
| 1. Propellers | 13. Heat Sinks |
| 2. Motors | 14. Liquid Level Gauge |
| 3. ESCs | 15. Spray Tank |
| 4. Aircraft Front Indicators
(on the M2 and M6 arms) | 16. Battery Compartment |
| 5. Frame Arms | 17. Forward FPV Camera |
| 6. Folding Detection Sensors (built-in) | 18. Backward FPV Camera |
| 7. Hoses | 19. Landing Gear |
| 8. Sprinklers | 20. OcuSync Antennas |
| 9. Nozzles | 21. Onboard D-RTK Antennas |
| 10. Electromagnetic Exhaust Valves | 22. Aircraft Status Indicators
(on the M1 and M4 arms) |
| 11. Omnidirectional Digital Radar | 23. Aircraft Rear Indicators
(on the M3 and M5 arms) |
| 12. Upward Radar (built-in) | |

Remote Controller Overview

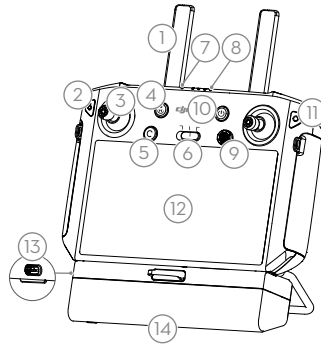

1. Antennas

Relays aircraft control and image transmission signal.

2. Back Button / Function Button

Press once to return to the previous page. Hold to view a guide to using button combinations. Refer to [Button Combinations \(p. 38\)](#) for more information.

3. Control Sticks

Controls aircraft movement. Control mode can be set in the app.

4. RTH Button

Press and hold this button to initiate RTH.

5. Button C3 (customizable)

6. Flight Mode Switch

The three positions are P-mode (Positioning), A-mode (Attitude), and P-mode (Positioning).

7. Status LED

Indicates whether the remote controller is linked to the aircraft.

8. Battery Level LEDs

Displays current battery level of the internal battery.

9. 5D Button (customizable)

10. Power Button

Used to power the remote controller on and off. When the remote controller is powered on, press the button to enter sleep mode or to wake up the controller.

11. Confirm Button

Press to confirm a selection.

12. Touch Screen

Tap to select. Android-based device to run DJI AGRAS.

13. USB-C Charging Port

Use to charge the remote controller.

14. Dongle Compartment Cover

Open the cover to mount or remove the 4G dongle.

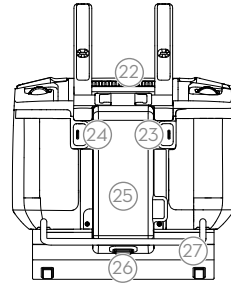
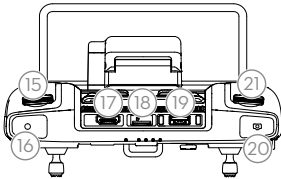

- 15. **Spray Rate Dial**
Turn to adjust the spray rate in Manual operation mode.
- 16. **Spray Button**
Press to start or stop spraying in Manual operation mode.
- 17. **HDMI Port**
For video output.
- 18. **microSD Card Slot**
Used to insert a microSD card.
- 19. **USB-A Port**
Used to connect devices such as an RTK Dongle, or to connect to a computer to update firmware and export logs via the DJI Assistant 2 software.
- 20. **FPV / Map Switch Button**
In Operation View in DJI Agras, press to switch between FPV and the Map View.
- 21. **Reserved Dial**
- 22. **Air Outlet**
Used for heat dissipation. DO NOT cover the air vent during use.
- 23. **Button C1 (customizable)**
When planning a field, press the button to switch between Obstacle mode and Waypoints mode. The function of the button cannot be customized while planning a field. When not planning a field, use the app to customize the button.
- 24. **Button C2 (customizable)**
When planning a field, press the button to add a waypoint or an obstacle point. The function of the button cannot be customized when planning a field. When not planning a field, use the app to customize the button.
- 25. **Battery Cover**
Open the cover to mount or remove the Intelligent Battery from the remote controller.
- 26. **Battery Compartment Cover Lock**
Press the lock to open the cover.
- 27. **Handle**

Aircraft

Aircraft Profile

The aircraft uses a dedicated DJI industrial flight controller to provide multiple operation modes for various applications. The Spherical Radar System provides terrain following and obstacle circumvention in all horizontal directions as well as obstacle sensing in all horizontal directions and upward direction. The aircraft comes equipped with other functions such as operation resumption, system data protection, empty tank warning, smart supply reminder, low battery level warning, and RTH.

Flight Modes

The aircraft will fly in P-mode by default. Users can switch between flight modes by toggling the Flight Mode switch on the remote controller when A-mode is enabled in the app.

P-mode (Positioning): The aircraft utilizes GNSS or the RTK module for positioning. When the GNSS signal is strong, the aircraft uses GNSS for positioning. When the RTK module is enabled and the differential data transmission is strong, it provides centimeter-level positioning. It will revert to A-mode when the GNSS signal is weak or when the compass experiences interference.

A-mode (Attitude): GNSS is not used for positioning and the aircraft can only maintain altitude using the barometer. The flight speed in A-mode depends on its surroundings such as the wind speed.

Attitude Mode Warning

In A-mode, the aircraft cannot position itself and is easily affected by its surroundings, which may result in horizontal shifting. Use the remote controller to position the aircraft.

Maneuvering the aircraft in A-mode can be difficult. Avoid flying in confined spaces or in areas where the GNSS signal is weak. Otherwise, the aircraft will enter A-mode, leading to potential flight risks. Land the aircraft in a safe place as soon as possible.

Operation Modes

The T30 provides Route, A-B Route, Manual, and Manual Plus operation modes. Users can use DJI Agras to switch between A-B Route, Manual, and Manual Plus.

Route Operation Mode

After the task area and obstacles have been measured and settings have been configured, the DJI Agras app uses the built-in intelligent operation planning system to produce a task route based on the input of the user. Users can invoke an operation after planning a field. The aircraft will begin the operation automatically and follow the planned task route. Once prescription maps are added during field planning or editing, the aircraft performs variable rate fertilization according to the information included in the maps. Connection routing, smart supply reminder, operation resumption, altitude stabilization, obstacle avoidance, and obstacle circumvention are available in Route Operation mode. Use the app to adjust the spray amount and flight speed. Route operation mode is recommended for large spray areas.

Importing Prescription Maps

Import prescription maps to the remote controller first in order to perform variable rate fertilization.

1. Store the prescription tasks planned in DJI Terra to a microSD card.
2. Insert the microSD card to the remote controller, go to the home screen in DJI Agras. Select the files in the prompted window and import.
3. Imported prescription maps will be displayed on the Prescription Map tag in the  task management screen.

Field Planning

DJI Agras supports multiple planning methods for various applications.

Walk with RTK

Walking with an RTK dongle uses the RTK dongle connected to the remote controller to record measurements. Make sure that the aircraft is powered off when planning your flight route.



1. Make sure that the RTK dongle is mounted to the remote controller.
2. Power on the remote controller, swipe from the top of the screen, and make sure that USB is disabled.
3. Go to the home screen in the app, tap Plan Field, and select Walk with RTK.
4. Go to , tap RTK to select the RTK source, and complete configuration. Wait until the system status bar in the upper left corner of the screen turns green, indicating that RTK positioning is in use.



Plan a field by following the instructions for walking with the remote controller below. Users can also enter the Field Editing screen and use the crosshair to add boundary points and obstacles. Refer to the Field Editing section for more information.

5. Walk with the remote controller alongside the boundary of the task area and tap Add Waypoint C2 or press the C2 button on the remote controller at turning points.
6. Mark any obstacles:

Use one of the two methods below to mark any obstacles in or out of a target field. Obstacles that are marked outside of the task area during field planning will be avoided when planning a connection route for Connection Routing. Refer to Connection Routing for more information.

- ① Tap Obstacle Mode C1 onscreen or press the C1 button on the back of the remote controller. Next, walk with the remote controller around the obstacle and tap Add Obstacle C2 onscreen or press the C2 button to add points for the obstacle. Finally, tap Waypoints Mode C1 or press the C1 button when finished.
- ② Tap Obstacle Mode C1 onscreen or press the C1 button on the back of the remote controller. Next, walk with the remote controller to the obstacle, and then tap Round. A red circle will appear on the map. Tap the center of the circle to select the obstacle and drag to adjust the position. Select the red point on the circumference of the obstacle and drag to adjust the radius. Finally, tap Waypoints Mode C1 or press the C1 button when finished.
7. Continue measuring the field by walking with the remote controller alongside the boundary and adding waypoints at each corner of the field. Tap Done when the field has been measured and all obstacles have been marked. The app produces a flight route according to the perimeter and obstacles of the field.
8. Add prescription map: tap  on the screen and select a prescription map from the list for a preview. Each area of the field on the map will be displayed in a color corresponding to the amount of material. Tap Yes to apply the selected prescription map to the field included in the map. Users can also add a prescription map while editing a field or before performing an operation.
9. Calibration points can be added when Rectify Offset is enabled in  under .

Add calibration point: Walk with the remote controller to the location of each calibration point. Tap Calibration Point onscreen.

The calibration points are used to offset the bias of the flight route caused by the positioning difference. Choose at least one existing landmark as the fixed reference point for calibration when executing the same operation. If none are available, use an easily identifiable object such as a metal stake.

Walk with RC

Users should walk along the boundary of the field or the obstacles with the remote controller for measurements. Make sure that the aircraft is powered off when planning your flight route.

1. Power on the remote controller and enter DJI Agras. Tap Plan Field and select Walk with RC.
2. Wait until the GNSS signal is strong. Positioning accuracy may vary by +/-2 meters. Complete the remaining steps by walking with the remote controller following the same instructions as the Walk with RTK section.

Fly the Aircraft

Users can fly the aircraft to desired positions and use the app or the remote controller to add waypoints for outlining areas and measuring obstacles.

1. Power on the remote controller, enter DJI Agras, and then power on the aircraft.
2. Tap Plan Field and select Fly the Aircraft. Complete the remaining steps by flying the aircraft following the same instructions as the Walk with RTK section.

DJI Terra

1. Make sure to read the DJI Terra User Manual for field planning before sharing the planned data to DJI AG platform or storing the data to the microSD card in the remote controller.
2. Using the planning data
 - a. Download from the DJI AG platform:

To view the data on the platform, go to the home screen of DJI Agras and tap  to synchronize data. Select the desired data for field editing.
 - b. Import from the microSD card:

Insert the microSD card with the planning data from DJI Terra into the microSD card slot on the remote controller. Next, go to the home screen of DJI Agras. Select the data in the prompted window and import it. To view the data, go to  task management on the home screen. Select the desired data for field editing.

Field Editing

Tap Field Editing on the onscreen map to enter Edit Status.

1. Edit Waypoints

Move: tap the waypoint once and then drag to move.

Fine Tuning: tap the waypoint. In the Waypoints tag in Field Editing, and tap Fine Tuning buttons. Tap Previous or Next to switch between different waypoints.

Delete: tap the  icon in the Waypoints tag or tap the waypoint twice to delete a selected waypoint.

2. Adjust Route

The following parameters can be adjusted on the map.

Route Direction: tap and drag the  icon near the route to adjust the flight direction of the planned route. tap the icon to show the Fine Tuning menu and adjust.

The following parameters can be adjusted under the Route tag in Field Editing settings.

Widen Overall Margin: adjust the safety margin between the route and the edge of the field.

Widen One Side: tap any edge of the field, then enable this option and adjust the single safety margin for the corresponding edge. Tap Previous or Next to switch between different edges.

Route Spacing: adjust the route spacing between two neighboring lines. If Auto Route Spacing Adjustment is enabled in Advanced Settings under Aircraft Settings, fine tuning is applied automatically after users adjust the value of the spacing. This will make the route more suitable for the task area. The spacing value displayed may vary slightly from the user input.

Obstacle Edge Safety Distance: adjust the safety margin between the route and the edge of the obstacle.

Auto Boundary Route: once enabled, the aircraft will fly and spray around the boundary of the field after the original task route is completed. Afterward, the aircraft will perform the preset action for when the task route is completed. The boundary route can be set to clockwise or counterclockwise.

Low Speed Ascent: when enabled, the aircraft will ascend by the preset height amount if flying at a low speed to maintain a safe distance from the ground and avoid damaging vegetation. The aircraft normally flies at a low speed when turning on a task route. The aircraft will automatically descend once the flight speed returns to normal.

3. Edit Obstacles

For polygonal obstacles, follow the Edit Waypoints instructions to edit the added points around the obstacle. For circular obstacles, tap the center of the circle to select the obstacle and drag to adjust the position. Select the red point on the circumference of the obstacle and drag to adjust the radius.

4. Add More Boundary Points or Obstacles

On the Field Editing screen, use the crosshair, remote controller, or aircraft to add more boundary points or obstacles. The instructions below use the crosshair as an example.



A more accurate map is required to add points using the crosshair. It is recommended to select a map source in HD Second-layer Map in **...** under to improve the accuracy of the added points.

- a. Select Crosshair in the Add Point list on the right of the screen. A crosshair will be displayed in the center of the map.
- b. Select Boundary Point, Obstacle, or Round from the Type of Point list. Drag the map to align the crosshair and tap Add to add the corresponding type of point.
- c. Follow the Edit Waypoints and Edit Obstacles instructions to edit the added points accordingly.

5. Add Prescription Maps

Tap on the screen. Select a prescription map from the list to preview. Each area of the field on the map will be displayed in a color corresponding to the amount of material. Tap Yes to apply the selected prescription map to the field.



6. Tap Back, then Done, name the operation, choose crop, and configure other parameters.

Performing an Operation

1. Power on the remote controller and aircraft.
2. Go to the home screen in DJI Agras and tap Execute Operation to enter the Operation View.
3. Tap to select a field in Fields tag.
4. Tap on the center of the field to add a prescription map.
5. Tap Edit to edit the waypoints and route again and add more boundary points or obstacles.
6. Tap Invoke.
7. Tap Move Flight Route to adjust the position of the route using the fine-tuning buttons if Rectify Offset is disabled under **...** Settings. If Rectify Offset is enabled under **...** Settings, place the aircraft at one of the previously set calibration points, tap Rectify Offset then Rectify Aircraft Position, and tap OK.
8. Connection Routing enables the aircraft to rejoin a task route automatically and safely. It is recommended to mark all obstacles outside the task area during field planning. Users can add connection points where necessary to change the connection route to circumvent obstacles that were not marked during field planning. Refer to the descriptions below for more information.

9. Set operation parameters, tap OK, and tap Start.
10. Set an appropriate auto-takeoff height and speed by setting the Connection Routing and RTH Altitude and Connection Routing and RTH Speed, move the slider to take off, and start spraying.

 The Connection Routing and RTH altitude and speed can be adjusted under Pre-Task Auto Check and Aircraft Settings. If it is adjusted in one location, it will automatically be updated in the other location too.

-  • Only take off in open areas and set an appropriate auto-takeoff height according to the operating environment.
- The operation is automatically cancelled if the motors are started before beginning the operation. You will need to recall the operation in the task list.
 - Once started, the aircraft flies to the starting point of the route and locks its heading in the direction of the first turning point for the duration of the flight route. During operation, users cannot control the aircraft heading via the control stick.
 - The aircraft does not spray while flying along route spacing, but automatically sprays while flying along the rest of the route. Users can adjust the spray amount, flying speed, and the height above vegetation in the app.
 - An operation can be paused by moving the control stick slightly. The aircraft will hover and record the breakpoint, and then the aircraft can be controlled manually. To continue the operation, select it again from the Executing tag in , and the aircraft will return to the breakpoint automatically and resume the operation. Pay attention to aircraft safety when returning to a breakpoint.
 - Users can set the action the aircraft will perform after the operation is completed in the app.
-

Connection Routing

 **Connection Routing:** refers to the procedure where the aircraft flies from the current position to the task route. Only available in Route operation mode.

Connection Routing returns the aircraft from its current position to the task route and automatically avoids any obstacles that were marked outside of the task area during field planning. Users can add connection points, which the aircraft must fly through on the connection route to circumvent the obstacles that were not marked during field planning. Connection Routing is only available in Route operation mode.

1. It is recommended to mark all obstacles inside or outside of the task area during field planning. After entering or resuming a Route operation, the connection route calculated by Connection Routing will be displayed on the map automatically.
2. Similar with the operation of crosshair for field editing, drag the map to align the crosshair to the desired position and tap Add Connection Point. Tap a connection point twice to delete. Multiple connection points can be added. The aircraft will fly through all the connection points in the order that they were added.
3. Tap OK and then Start, set the Connection Routing and RTH Altitude and Connection Routing and RTH Speed in Pre-Task Auto Check, and move the slider to start the operation. Connection Routing and RTH Altitude and Connection Routing and RTH Speed can also be set in Aircraft settings.
4. The aircraft flies along the connection route including through any connection points that have been marked along the way.

A-B Route Operation Mode

In A-B Route operation mode, the aircraft travels along a pre-planned route. Operation resumption, data protection, altitude stabilization, obstacle avoidance, and auto obstacle circumvention functions of the radar module are available in this mode. Use the app to adjust the flying speed and spray amount. A-B Route operation mode is recommended for large, triangular, or rectangular spray areas.

Operation Route

The aircraft travels along a planned square zig-zag route after recording turning points A and B. Under optimal working conditions, the obstacle avoidance and auto obstacle circumvention functions are available and the aircraft maintains the same distance from the vegetation. The length of the dotted lines, called route spacing, can be adjusted in the app. If users adjust the heading for points A and B after the points are recorded, the turning angles for the turning points of the operation route will change according to the preset heading for points A and B. The shape of the operation route will also change, for example, as Route L' and Route R' in the figure below.

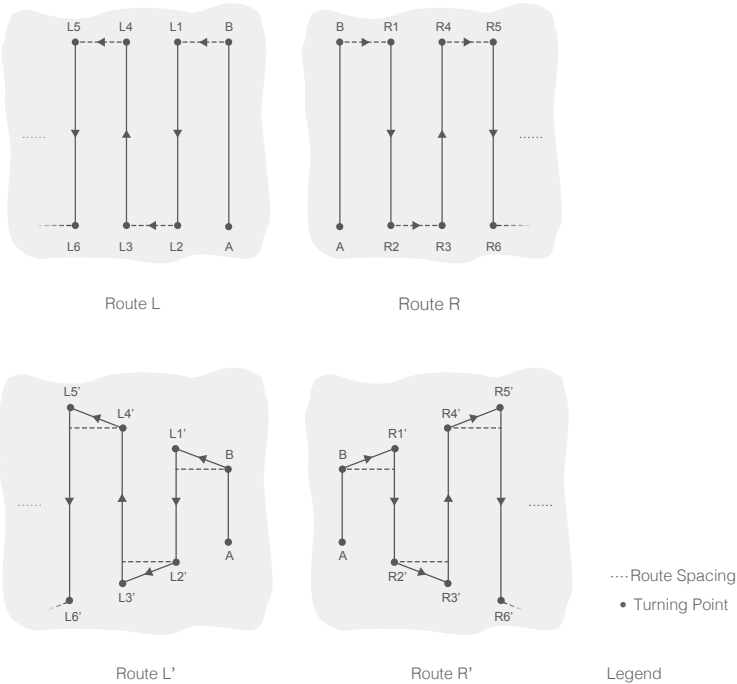

Operation Procedure

-  • Maintain VLOS of the aircraft at all times.
 - Make sure that the GNSS signal is strong. Otherwise, A-B Route operation mode may be unreliable.
-

-  Make sure to inspect operating environments before flying.
-

Set the operation mode switch button to M (Manual operation mode) when a strong GNSS signal is present and the onscreen display is Manual Route (GNSS) or Manual Route (RTK). Fly the aircraft to a safe height.

1. Enter A-B operation mode

Go to Operation View in the app, tap the operation mode switch button in the upper left corner, and select A-B operation mode.

2. Record Points A and B in order

Fly the aircraft to the starting point, depicted as Point A or B, hover, and tap Point A or B onscreen or press the preset customizable button on the remote controller. Point A or B appears on the map after recording the starting points. If the heading for Point A or B is required to be adjusted, the heading for Point A should be adjusted after Point A is recorded and then users can record Point B and adjust the heading for Point B.

-  • Points A and B cannot be recorded if the spray tank is empty or the flying speed of the aircraft is higher than 0.4 m/s.
 - Make sure to record Point A before Point B, and that the distance between Point A and B is more than 1 m.
 - Update Point B by flying the aircraft to a new position to record. Note that if Point A is updated, Point B must be too.
 - For optimal performance, it is recommended to keep the direction of Point A to B parallel to one side of the polygonal spray area.
-

3. Adjust heading for Point A and B

After Point A or B is recorded, tap Adjust A or B Heading onscreen, and move the yaw stick on the remote controller. The heading of the aircraft refers to the heading for Point A or B that is indicated by a dotted line on the screen. Tap Adjust A or B Heading again to set the current heading for Point A or B. After adjusting the heading for Point A, Point B cannot be recorded inside of a range of 30° on the left or right of the dotted line indicating the heading for Point A. When adjusting the heading for Point B, the dotted line indicating the heading for Point B cannot be inside of a range of 30° on the left or right of the line from A to B. Take note of the prompts in the app when operating.

-  The heading for Point A or B cannot be set when the rotating speed of the aircraft's heading is higher than 15°/s.
-

4. Select the route

After Point A and B are recorded, the app produces Route R or Route R' by default. Tap Change Direction on the lower right corner of the screen to switch to Route L or Route L'.

5. Set the operation parameters

Tap Parameter Configuration on the left of the screen to set the spray amount, flight speed, route spacing, and height above the vegetation. Under optimal working conditions, the radar module starts working automatically and maintains the spraying distance between aircraft and vegetation after performing the operation.



The route spacing cannot be adjusted during operation. Switch to Manual operation mode to adjust the value, then return to A-B Route operation mode.

6. Performing an operation

Tap Start on the lower right corner of the screen and move the slider to start the operation.



- If, after recording Points A and B, you fly the aircraft more than five meters away from Point B, Resume appears at the lower right corner of the screen. Tap Resume, and the aircraft automatically flies to Point B to perform the operation.
- If the GNSS signal is weak during the operation, the aircraft enters Attitude mode and exits from A-B Route operation mode. Operate the aircraft with caution. The operation can be resumed after the GNSS signal is recovered.
- If you press the A or B button during operation while the flying speed of the aircraft is lower than 0.3 m/s, the data for Points A and B of the current route is erased and the aircraft hovers in place.



- Users cannot control the aircraft heading via the control stick during the operation.
- When using the control sticks to control the aircraft in A-B Route operation mode, the aircraft automatically switches to Manual operation mode, completes the corresponding flight behavior, and then hovers. To resume the operation, tap Resume onscreen. The aircraft resumes flying along the operation route. Refer to [Operation Resumption \(p. 22\)](#) for more information.
- Even though the heading of the aircraft cannot be adjusted, use the control sticks to avoid obstacles if the obstacle avoidance function of the radar module is disabled. Refer to [Manual Obstacle Avoidance \(p. 23\)](#) for more information.
- During the operation, the aircraft does not spray liquid while flying along the route parallel to the line from A to B, but automatically sprays liquid while flying along the other parts of the route.

Manual Operation Mode

Tap the operation mode switch button in the app and select M to enter Manual operation mode. In this mode, you can control all the movements of the aircraft, spray liquid via the spray button of the remote controller, and adjust the spray rate via the dial. Refer to [Controlling the Spraying System \(p. 36\)](#) for more information. Manual operation mode is ideal when the operating area is small.

Manual Plus Operation Mode

Tap the operation mode switch button in the app and select M+ to enter Manual Plus operation mode. In this mode, the maximum flying speed of the aircraft is 7 m/s (customizable in the app), the heading is locked, and all other movement can be manually controlled. Users can disable the M+ heading lock in Parameters Configuration. Under optimal working conditions, the radar module maintains the spraying distance between aircraft and vegetation if the altitude stabilization function is enabled. Press

the corresponding buttons onscreen or customizable buttons on the remote controller (if customized) to steer the aircraft left or right. The aircraft automatically sprays when accelerating forward, backward or diagonally, but does not spray when flying sideward. Manual Plus operation is ideal for irregularly-shaped operating areas.



- The route spacing cannot be adjusted during operation. Switch to Manual operation mode to adjust the value, then return to Manual Plus operation mode.
 - The spray rate will be adjusted automatically according to the flying speed.
 - In the app, users can adjust the spray amount, flying speed and height above the vegetation.
-

Operation Resumption

When exiting a Route or an A-B Route operation, the aircraft records a breakpoint. The Operation Resumption function allows you to pause an operation temporarily to refill the spray tank, change the battery, or avoid obstacles manually. Afterwards, resume operation from the breakpoint.

Recording a Breakpoint

Users can record the location of an aircraft as a breakpoint. If the GNSS signal is strong, a breakpoint is recorded in the following scenarios during Route or A-B Route operations.

1. Tap the Pause or End button at the lower right corner of the screen. Note: tapping the End button during an A-B Route operation does not make the aircraft record a breakpoint. The operation ends immediately and cannot be resumed.
 2. Initialize RTH.
 3. Toggle the pause switch.
 4. Push the pitch or roll stick in any direction on the remote controller.
 5. Obstacle detected. The aircraft brakes and enters obstacle avoidance mode.
 6. Radar module error detected when the obstacle avoidance function is enabled.
 7. The aircraft reaches its distance or altitude limit.
 8. Empty tank.
 9. If the GNSS signal is weak, the aircraft enters Attitude mode and exits the Route or A-B Route operation. The last position where there was a strong GNSS signal is recorded as a breakpoint.
-



- Make sure that the GNSS signal is strong when using the Operation Resumption function. Otherwise, the aircraft cannot record and return to the breakpoint.
 - The breakpoint is updated as long as it meets one of the above conditions.
 - If the operation is paused for longer than 20 minutes during an A-B Route operation, the system automatically switches to Manual operation mode and erases the breakpoint.
-

Resuming Operation

1. Exit a Route or A-B Route operation through one of the above methods. The aircraft records the current location as the breakpoint.
2. Fly the aircraft to a safe location after operating the aircraft or removing the conditions for recording a breakpoint.

3. Return Route

The default return route is to fly back to the breakpoint. Users can also select a return point from the list of return points on the screen, which means returning to the task route following a perpendicular line. To resume operations when the end button has been tapped to exit a Route operation, select the Executing tag in the operation list to use the operation again and select the return route.

- 4. Tap Resume in the lower right corner of the screen and the aircraft will fly to the task route by following the selected return route and continue spraying. Connection Routing can be used to return to the task route in Route operation mode.
- 5. If obstacle avoidance is required when returning to the route, users can enable the aircraft to move forward, backward, and sideward. Refer to Manual Obstacle Avoidance for more information.

Typical Applications

In Route or A-B Route operation mode, users can control the aircraft forward, backward, and sideward, avoiding obstacles along the operation route, or in an emergency such as when the aircraft is experiencing abnormal behavior. The following instructions describe how to avoid obstacles manually:

Manual Obstacle Avoidance

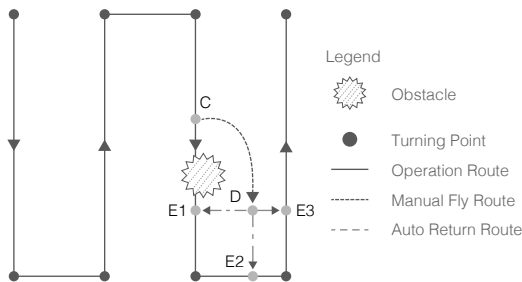

1. Exiting a Route or A-B Route operation

In both modes, when using the control sticks to control the aircraft forward, backward, or sideward, the aircraft automatically switches the current mode to Manual operation mode, pauses the operation, records the current position as a breakpoint (Point C), completes the corresponding flight behavior, and hovers.

⚠ When pushing the control sticks to exit the operation, the aircraft requires a braking distance. Make sure that there is a safe distance between the aircraft and any obstacles.

2. Avoiding an Obstacle

After switching to Manual operation mode, users can control the aircraft to avoid the obstacle from Point C to D.

3. Resuming Operation

Select one of the three return points marked as E1, E2, or E3. Tap resume and the aircraft flies from the point marked D to the selected return point following a perpendicular line.

- ⚠ • The amount of selectable return points is related to the position of the aircraft. Select according to the app display.
 - Make sure that the aircraft has completely avoided the obstacle before resuming operation.
 - In the event of an emergency, make sure that the aircraft is operating normally and fly the aircraft manually to a safe area to resume operation.
-
- ☀ • Repeat the instructions above to exit and resume operation in the event of an emergency when returning to the route, such as whenever obstacle avoidance is required.
-

System Data Protection

In Route or A-B Route operation mode, the System Data Protection feature enables the aircraft to retain vital system data such as operation progress and breakpoints after the aircraft is powered off to replace a battery or refill the spray tank. Follow the instructions in Operation Resumption to resume the operation after restarting the aircraft.

During Route operations, in situations such as when the app crashes or the remote controller disconnects from the aircraft, the breakpoint will be recorded by the flight controller and recovered automatically in the app once the aircraft is reconnected. If recovery is not performed automatically, users can perform the operation manually. Go to Operation View, select ⚙, ⚙, then Advanced Settings, and tap Continue Unfinished Task. Recall the operation in the Executing tag in the operation list.

Spherical Radar System

Profile

The Spherical Perception Radar System, consisting of the Omnidirectional Digital Radar and Upward Radar, works during day and night and is unaffected by light or dust. In an optimal operating environment, the omnidirectional digital radar can predict the distance between the aircraft and the vegetation or other surfaces in forward, backward, and downward directions to fly at a constant distance to ensure even spraying and terrain following capability. The radar system can detect obstacles in all horizontal directions from 30 m away and from 15 m above in the upward direction. It effectively senses the environment and helps to circumvent obstacles in both Route and A-B Route operation modes. In addition, the radar module limits the descent speed of the aircraft according to the distance between the aircraft and ground in order to provide a smooth landing.

The altitude stabilization and obstacle avoidance functions of the radar module are enabled by default and can be disabled in the app. When enabled, the aircraft flies above the vegetation at a constant spraying distance in Route, A-B Route, and Manual Plus operation modes. In Manual operation mode, the radar module can measure the spraying distance above the vegetation or other surfaces, but the aircraft is not able to fly at a constant spraying distance. Obstacle avoidance can be used in any mode. Auto Obstacle Avoidance is disabled by default. Users can enable it in the app.

Detection Range

The obstacle detection distance of the omnidirectional digital radar is 1.5-30 m while the upward radar has a detection distance of 1.5-15 m. The FOV of the system is shown in the figure below. The aircraft cannot sense obstacles that are not within the detection range. For the four gray areas in the figure, the detection performance of the radar module may be reduced due to the obstruction of the frame arms and landing gear. Fly with caution.

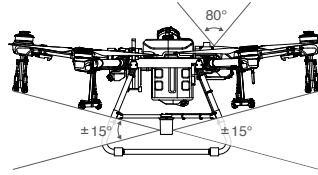
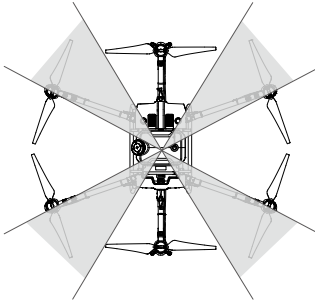

⚠ The effective detection distance varies depending on the size and material of the obstacle. When sensing objects such as buildings that have a radar cross section (RCS) of more than -5 dBsm, the effective detection distance is 20 to 30 m. When sensing objects such as power lines that have a RCS of -10 dBsm, the effective detection distance is approximately 15 m. When sensing objects such as dry tree branches that have a RCS of -15 dBsm, the effective detection distance is approximately 10 m. Obstacle sensing may be affected or unavailable in areas outside of the effective detection distance.

Omnidirectional Digital Radar Usage

Obstacle Avoidance Function Usage

Make sure the horizontal obstacle avoidance function of the radar module is enabled in the app. Obstacle avoidance is used in the following two scenarios:

1. The aircraft begins to decelerate when it detects an obstacle is 15 m away and brakes. While braking, users can not accelerate in the direction of the obstacle but can fly in a direction away from the obstacle. The aircraft will hover in place if the user does not perform any action. Fly in a direction away from the obstacle to regain full control of the aircraft.
2. The aircraft immediately brakes and hovers if it detects an obstacle nearby. Users cannot control the aircraft while it is braking. Users can fly in a direction away from the obstacle to regain full control of the aircraft.

Altitude Stabilization Function Usage

1. Make sure that you have enabled the altitude stabilization function of the radar module in the app.
2. Enter the desired operation mode, and configure the desired spraying distance.
3. If the operating environment is ideal, the aircraft flies above the vegetation at the preset height.

Obstacle Circumvention Function Usage

1. Make sure that you have enabled the horizontal obstacle avoidance function of the radar module in the app, and enable Auto Obstacle Avoidance. Note that Auto Obstacle Avoidance is disabled if Horizontal Obstacle Avoidance is disabled.
2. Perform a Route or A-B Route operation. During auto flight, when obstacles are detected, the aircraft plans a flight route to circumvent the obstacles.

3. The aircraft flies along the planned flight route to circumvent the obstacles. Once the obstacles are circumvented, the aircraft returns to the operation route.
4. The aircraft hovers in place if a prompt is received in the app indicating that the aircraft failed to circumvent the obstacle. Users can manually control the aircraft to avoid the obstacles. Refer to [Manual Obstacle Avoidance \(p. 23\)](#) for more information.

Upward Radar Usage

Make sure the upward obstacle avoidance function of the radar module is enabled in the app. Obstacle avoidance is used in the following two scenarios:

1. The aircraft begins to decelerate when it detects an obstacle is 3 m away and brakes and hovers in place.
2. The aircraft immediately brakes if it detects an obstacle nearby.

Users cannot accelerate in the direction of the obstacle, but can fly in a direction away from the obstacle when the aircraft is braking or hovering.

Radar Usage Notice



- DO NOT touch or let your hands or body come in contact with the metal parts of the radar module when powering on or immediately after flight as they may be hot.
- In Manual operation mode, users have complete control of the aircraft. Pay attention to the flying speed and direction when operating. Be aware of the surrounding environment and avoid the blind spots of the radar module.
- Obstacle Avoidance is disabled in Attitude mode.
- Obstacle Avoidance is adversely affected due to the obstruction of the aircraft body when aircraft pitch exceeds 15°. Slow down and fly with caution.
- When sensing objects that have a vertical inclination of more than 5° such as an inclined line or inclined utility pole, the sensitivity of the radar module may be reduced. Fly with caution.
- The radar module enables the aircraft to maintain a fixed distance from vegetation only within its working range. Observe the aircraft's distance from vegetation at all times.
- Operate with extra caution when flying over inclined surfaces. Recommended maximum inclination at different aircraft speeds: 10° at 1 m/s, 6° at 3 m/s, and 3° at 5 m/s.
- Maintain full control of the aircraft at all times and do not rely on the radar module and DJI Agras app. Keep the aircraft within VLOS at all times. Use your discretion to operate the aircraft manually to avoid obstacles.
- Comply with local radio transmission laws and regulations.
- The sensitivity of the radar module may be reduced when operating several aircraft within a short distance. Operate with caution.
- Before use, make sure that the radar module is clean and the outer protective cover is not cracked, chipped, sunken, or misshapen.
- DO NOT attempt to disassemble any part of the radar module that has already been mounted prior to shipping.
- The radar module is a precision instrument. DO NOT squeeze, tap, or hit the radar module.
- Land the aircraft on flat ground to avoid damage to the radar module from raised objects.
- DO NOT block the position on the aircraft shell where the upward radar is located underneath. Otherwise, upward obstacle avoidance may be affected.

-
- ⚠ • Make sure the position on the aircraft shell where the upward radar is located underneath is not cracked, chipped, or misshapen. Otherwise, upward obstacle avoidance may be affected.
-
- ☀ • If the radar module frequently detects obstacles incorrectly, check to make sure the mounting bracket and the aircraft landing gear are properly secured. If the radar module still does not work, contact DJI Support or a DJI authorized dealer.
 - Keep the protective cover of the radar module clean. Clean the surface with a soft damp cloth and air dry before using again.
-

Empty Tank Warning and Smart Supply Reminder

Profile

The T30 features empty tank warnings and smart supply reminder functions. The aircraft calculates the empty tank and refill points according to the preset remaining liquid level threshold, current remaining liquid level, aircraft status, and operation parameters and displays the points on the map. In Route operations, users can set the action the aircraft will perform for empty tank and refill points. For A-B Route, Manual, and Manual Plus operations, users can only set the empty tank warning and the action the aircraft will perform at the empty tank point.

-
- ☀ • The empty tank point will not be displayed on the map if the tank is not calculated to run out before the end of the task route.
 - For Route operations, when adding liquid to the spray tank or adjusting the operation parameters, the empty tank point will update dynamically on the operating route according to the amount of added liquid and the adjusted settings.
-

Usage



1. In Aircraft settings, set the empty tank action and also enable this action to be performed when reaching a refill point. In Spraying System settings, enable the display of empty tank and refill points.
2. When an empty tank warning appears in the app, the sprinklers automatically turn off and the aircraft performs the preset empty tank action.
2. Make sure that the aircraft is in Manual operation mode. Land the aircraft and stop the motors. Refill the spray tank and tightly secure the cover.
3. Take off in Manual operation mode and fly the aircraft to a safe position. Select an operation mode.

Orchard Configuration

The T30 supports the DJI's orchard configuration and branch-targeting technology designed for orchard spraying. Users can purchase the optional T30 Orchard Spray Package. Mount it to the aircraft to transform the aircraft into the Orchard Configuration. Refer to the T30 Orchard Spray Package Product Information for more information about installation. After transforming the aircraft to the Orchard Configuration, the settings must also be changed in advanced settings under Aircraft Settings in the app to Orchard.

Using the Phantom 4 RTK and DJI Terra, users can generate a task route for an orchard area in the Fruit Tree page in Agriculture Application. This task route can be used in DJI Agras for more precise and efficient orchard spraying.

Return to Home (RTH)

 **Home Point:** The default home point is the first location where your aircraft received strong GNSS signals . Note that the white GNSS icon requires at least four bars before the signal is strong.

RTH: RTH brings the aircraft back to the last recorded home point.

There are three types of RTH: Smart RTH, Low Battery RTH, and Failsafe RTH.

Smart RTH

Press and hold the RTH button on the remote controller when GNSS is available to enable Smart RTH. Both Smart and Failsafe RTH use the same procedure. With Smart RTH, you may control the altitude of the aircraft to avoid collisions when returning to the home point. Press the RTH button once or push the pitch stick to exit Smart RTH and regain control of the aircraft.

Low Battery RTH

Low Battery RTH is only available in Route and A-B Route operations. If the Low Battery Action is set to RTH in the Aircraft Battery settings in the app, the aircraft will pause the operation and enter RTH automatically when the aircraft battery level reaches the low battery threshold. During RTH, users can control the altitude of the aircraft to avoid collisions when returning to the home point. Press the RTH button once or push the pitch stick to exit RTH and regain control of the aircraft.

The aircraft will not enter RTH if the Low Battery Action is set to Warning in the Aircraft Battery settings in the app.

Failsafe RTH

 The aircraft will RTH or hover if the remote controller signal is lost. The action can be set in the app. Failsafe RTH will only be available if RTH is set.

Failsafe RTH is automatically activated if the remote controller signal is lost for more than three seconds, provided that the home point has been successfully recorded, the GNSS signal is strong , and the RTK module is able to measure the heading of the aircraft. The RTH continues if the remote controller signal is recovered, and users can control the aircraft using the remote controller. Press the RTH button once to cancel RTH and regain control of the aircraft.

RTH Illustration

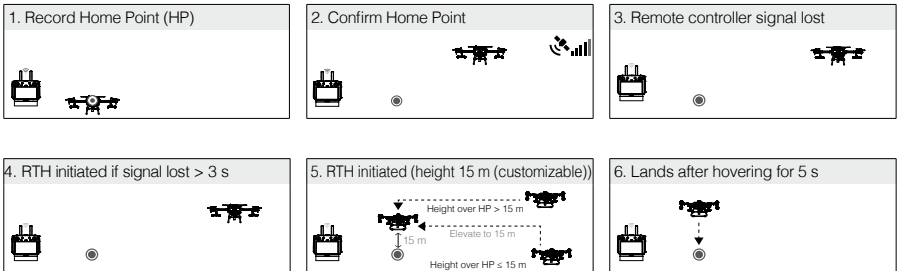

-  If RTH is triggered during Route operations, the aircraft can plan a flight path for RTH to circumvent the obstacles added when planning a field.







Updating the Home Point

You can update the home point in DJI Agras during flight. There are two ways to set a home point:

1. Set the current coordinates of the aircraft as the home point.
2. Set the current coordinates of the remote controller as the home point.

-  Make sure the space above the remote controller's GNSS module (located inside the place above the flight switch mode) is not obstructed and that there are no tall buildings around when updating the home point.

Follow the instructions below to update the home point:

1. Go to DJI Agras and enter Operation View.
2. Tap , then , and select  in Home Point Location settings to set the current coordinates of the aircraft as the home point.
3. Tap , then , and select  in Home Point Location settings to set the current coordinates of the remote controller as the home point.
4. The aircraft status indicators blink green to indicate that the new home point has been set successfully.

RTH Safety Notices



The aircraft will not enter RTH if RTH is triggered when the aircraft is within a 2 m radius of the Home Point, but the remote controller will still sound an alert. Exit RTH to cancel the alert.



The aircraft cannot return to the home point when the GNSS signal is weak (the GNSS icon displays red) or is unavailable.

Obstacle Avoidance During RTH

In an optimal operating environment, obstacle avoidance during RTH is available. If there is an obstacle within 20 m of the aircraft, the aircraft decelerates and then stops and hovers. The aircraft will exit the RTH procedure and wait for further commands.

Landing Protection Function

Landing Protection activates during auto landing. The procedure is as follows:

1. After arriving at the home point, the aircraft descends to a position 3 m above the ground and hovers.
2. Control the pitch and roll sticks to adjust the aircraft position and make sure the ground is suitable for landing.
3. Pull down the throttle stick or follow the onscreen instructions in the app to land the aircraft.

-  When using fixed RTK positioning, the aircraft will land directly instead of entering Landing Protection. Landing Protection is still available if the aircraft is performing a fruit tree route operation planned using DJI Terra.

Low Battery and Low Voltage Warnings

The aircraft features a low battery warning, critical low battery warning, and critical low voltage warning.

1. When the low battery warning prompt appears in the app, fly the aircraft to a safe area and land as soon as possible. Stop the motors and replace the battery. The aircraft will enter RTH automatically after the low battery warning prompt appears in the app if the Low Battery Action is set to RTH in the Aircraft Battery settings.
2. The aircraft will automatically descend and land when the critical low battery warning or critical voltage warning (battery voltage lower than 47.6 V) prompt appears in the app. Landing cannot be cancelled.



Users can set the threshold of low battery warnings in the app.

RTK Functions

The T30 has an onboard D-RTK. The heading reference of the aircraft from the dual antennas of the onboard D-RTK is more accurate than a standard compass sensor and can withstand magnetic interference from metal structures and high-voltage power lines. When there is a strong GNSS signal, the dual antennas activates automatically to measure the heading of the aircraft.

The T30 supports centimeter-level positioning to improve agricultural operation when used with the DJI D-RTK 2 Mobile Station. Follow the instructions below to use the RTK functions.

Enable/Disable RTK

Before each use, make sure that the aircraft RTK positioning function is enabled and the RTK signal source is correctly set to either D-RTK 2 Mobile Station or Network RTK. Otherwise, RTK cannot be used for positioning. Go to Operation View in the app, tap , and select RTK to view and set.



Make sure to disable the aircraft RTK positioning function if not in use. Otherwise, the aircraft is not able to take off when there is no differential data.

Using with the DJI D-RTK 2 Mobile Station

1. Refer to the D-RTK 2 Mobile Station User Guide for more information about completing the linking between the aircraft and the mobile station and setting up the mobile station.
2. Power on the mobile station and wait for the system to start searching for satellites. The RTK status icon on top of the Operation View in the app shows  to indicate that the aircraft has obtained and used the differential data from the mobile station.

Using with the Network RTK Service

The Network RTK service uses the remote controller instead of the base station to connect to an approved Network RTK server for differential data. Keep the remote controller on and connected to the internet when using this function.

1. Make sure that the remote controller is connected to the aircraft and has access to the internet.
2. Go to Operation View in the app, tap , and then RTK. Set the RTK signal source to Custom Network RTK, and input the network information.
3. Wait for the remote controller to be connected with the Network RTK server. The RTK status icon on top of the Operation View in the app shows  to indicate that the aircraft has obtained and used the RTK data from the server.

Aircraft LEDs

There are LEDs on the frame arms marked M1 to M6. The LEDs on M2 and M6 are front LEDs and glow red during flight to indicate the front of the aircraft. The LEDs on M3 and M5 are rear LEDs and glow green during flight to indicate the rear of the aircraft. The LEDs on M1 and M4 are aircraft status LEDs. They are turned off when the aircraft is in flight and indicate the aircraft status when the aircraft is grounded. Refer to the Appendix for more information on the aircraft status.

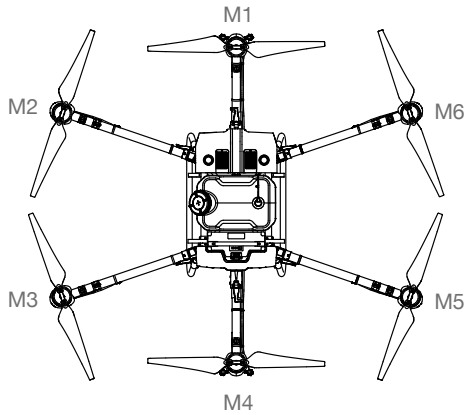

Remote Controller

Profile

The remote controller uses the DJI OcuSync Enterprise image transmission system, which has a maximum control distance of up to 7 km (4.35 mi). It includes a dedicated, Android-based display that runs DJI Agras independently for operation planning and aircraft status display. Its Multi-Aircraft Control mode (supported later) can be used to coordinate the operation of up to five aircraft at the same time to improve operation efficiency.

Using the Remote Controller

Powering the Remote Controller On and Off

Both the internal battery and external battery can be used to supply power to the remote controller. The battery level is indicated via the battery level LEDs on the remote controller or on the external battery.

Follow the steps below to power on the remote controller:

1. When the remote controller is powered off, press the power button once to check the current battery level of the internal battery. Press the battery level button on the external battery to check the current battery level of the external battery. If the battery level is too low, recharge before use.
2. Press the power button once, then press and hold to power on the remote controller.
3. The remote controller beeps when powered on. The status LED glows solid green when linking is complete.
4. Repeat Step 2 to power off the remote controller.

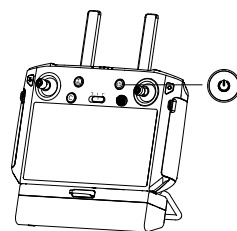



 When using an external Intelligent Battery, it is still necessary to make sure that the internal battery has some power. Otherwise, the remote controller cannot be powered on.

Charging the Batteries

Internal Battery

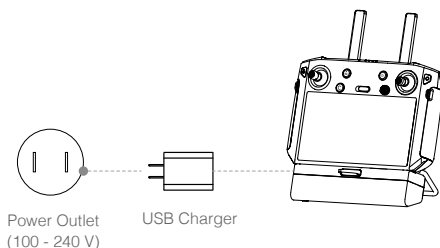
Charge the internal battery of the remote controller using the USB charger and USB-C cable.



-  Use an official DJI USB charger to charge the remote controller. If not, a USB charger certified FCC/CE rated 12 V/2 A is recommended.
- The battery will deplete when stored for an extended period of time. Recharge the battery at least once every three months to prevent over discharging.

The battery level LEDs on the remote controller indicates the status while charging. See the table below for details.

LEDs	Description
Blink successively quickly	The battery is being charged using a Quick Charge charger.
Blink successively slowly	The battery is being charged using a normal charger.
Solid	The battery is fully charged.

External Battery

Charge the external Intelligent Battery using the included AC power adapter and charging hub.

1. Place the battery into the charging hub, connect the AC power adapter to the charging hub, and connect the charger to a power outlet (100-240 V, 50/60 Hz).
2. The charging hub automatically charges batteries in order according to the battery power levels from high to low.
3. The Status LED blinks green when charging and turns solid green when fully charged. The charging hub beeps when charging is complete. To stop the beeping, remove the battery or turn off the button on the charging hub.

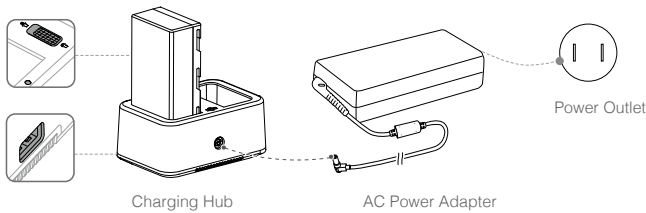

 Fully charge and discharge the battery at least once every three month.

 USB power supply port can be used to charge the mobile device of 5V/2A.

Status LED	Description
Blinks Green	Charging
Solid Green	Fully charged
Blinks Red	Battery charger error. Retry with an official battery charger
Solid Red	Battery error
Blinks Yellow	Battery temperature too high/low. Temperature must be within operating range (5°to 40°C (41°to 104° F))
Solid Yellow	Ready to charge
Blinks Green Alternately	Intelligent Battery not detected

Operating the Aircraft

This section explains how to control the orientation of the aircraft through the remote controller. Control can be set to Mode 1, Mode 2, or Mode 3.

Mode 1

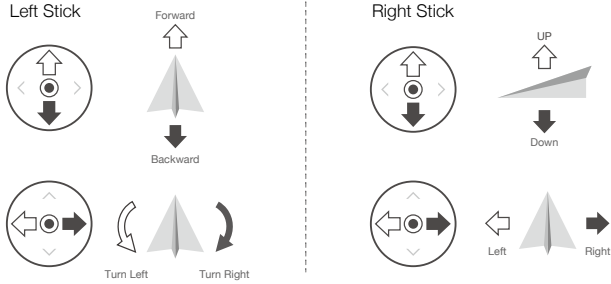

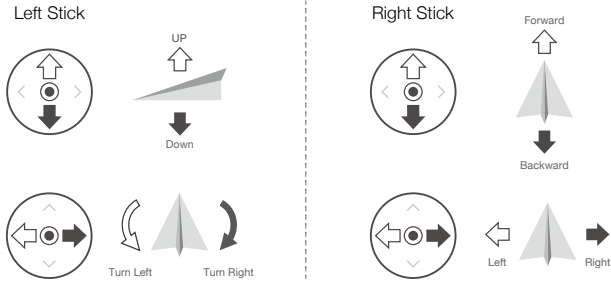

Mode 2

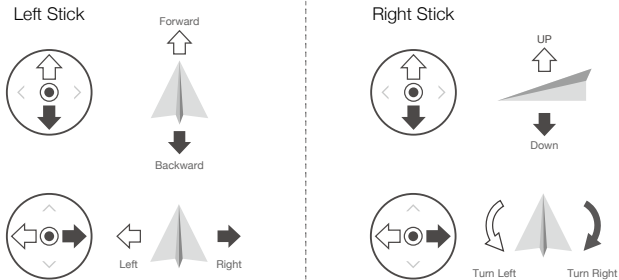

Mode 3

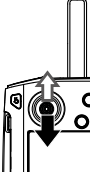
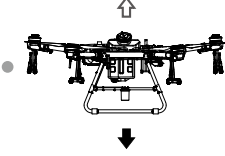
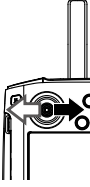
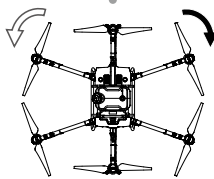
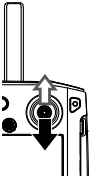

For example, the following description uses Mode 2:

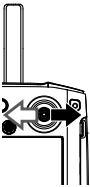
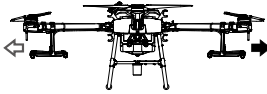
Remote Controller (Mode 2)	Aircraft (● Indicates nose direction)	Remarks
		<p>Throttle Stick: Move the left stick vertically to control the elevation of the aircraft.</p> <p>Push up to ascend and push down to descend. Use the left stick to take off when the motors are spinning at an idle speed. The aircraft hovers in place if the stick is in the center position. The further the stick is pushed away from the center position, the faster the aircraft changes elevation.</p>
		<p>Yaw Stick: Move the left stick horizontally to control the heading of the aircraft.</p> <p>Push left to rotate the aircraft counterclockwise and push right to rotate clockwise. The aircraft hovers in place if the stick is in the center position. The further the stick is pushed away from the center position, the faster the aircraft rotates.</p>
		<p>Pitch Stick: Move the right stick vertically to control the pitch of the aircraft.</p> <p>Push up to fly forwards and press down to fly backwards. The aircraft hovers in place if the stick is in the center position. Push the stick further for a larger pitch angle and faster flight.</p>
		<p>Roll Stick: Move the right control stick horizontally to control the roll of the aircraft.</p> <p>Push the stick left to fly left and right to fly right. The aircraft hovers in place if the stick is in the central position. Push the stick further for a larger roll angle and faster flight.</p>

Controlling the Spraying System

Complete an operation remotely via the spray rate dial or the spray and C1 or C2 buttons.

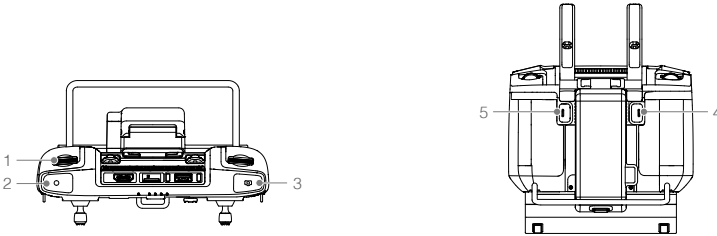

1. Spray Rate Dial

In Manual operation mode, turn left to reduce and right to increase the spray rate.* The app indicates the current spray rate.

2. Spray Button

In Manual operation mode, press to start or stop spraying.

3. FPV / Map Switch Button

In Operation View in DJI Agras, press to switch between FPV and the Map View.

4. Button C1

When planning a field, press the button to switch between Obstacle mode and Waypoints mode. The function of the button cannot be customized while planning a field.

When not planning a field, use the app to customize the button. For example, if the button is customized to record Point A, in A-B Route operations, press the button to record Point A of the operation route.

5. Button C2

When planning a field, press the button to add a waypoint or an obstacle point. The function of the button cannot be customized when planning a field.

When not planning a field, use the app to customize the button. For example, if the button is customized to record Point B, in A-B Route operations, press the button to record Point B of the operation route.

* Spray rate may vary according to the nozzle model and viscosity of the liquid.



The table below is a summary for how to control the spraying system in different modes using the remote controller.

Modes	Spray Rate Dial	Spray Button	FPV / Map Switch Button	Button C1	Button C2
Route operation mode	/	/	Switch the display	Customizable	Customizable
A-B Route operation mode	/	/	Switch the display	Customizable	Customizable
Manual operation mode	Adjust spray rate	Start or stop spraying	Switch the display	Customizable	Customizable
Manual Plus operation mode	Adjust spray rate	/	Switch the display	Customizable	Customizable
Field Planning	/	/	/	Obstacle mode/ Waypoint mode	Add waypoint/ obstacle point

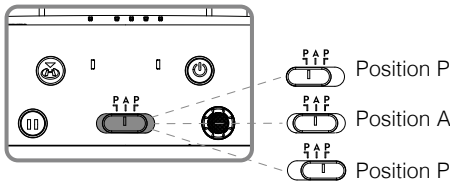
Flight Mode Switch



Position	Flight Mode
P	P-mode (Positioning)
A	A-mode (Attitude)
P	P-mode (Positioning)

Regardless of the position the switch is in on the remote controller, the aircraft begins in P-mode by default. To switch flight modes, first go to Operation View in DJI Agras, tap , then , and enable "Enable Attitude Mode" in Advanced Settings. After enabling attitude mode, toggle the switch to P and then to A to switch the flight mode to Attitude mode.

The aircraft still begins in P-mode by default after powering on, even though A-mode was enabled in the app beforehand. When A-mode is required, toggle the Flight Mode switch as mentioned above after powering on the remote controller and aircraft.

RTH Button

Press and hold the RTH button to bring the aircraft back to the last recorded home point. The LED around the RTH Button blinks white during RTH. Users can control aircraft altitude while it flies to the home point. Press this button again to cancel RTH and regain control of the aircraft.

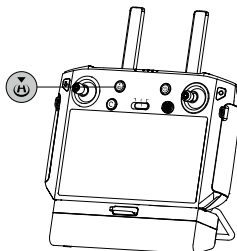

Optimal Transmission Zone

When the angle between the antennas and the back of the remote controller is 80° or 180°, the connection between the remote controller and aircraft can reach its optimal performance.

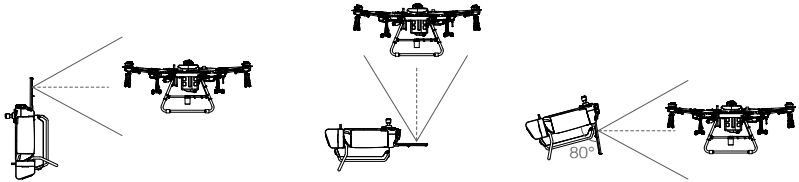

Try to keep the aircraft inside the optimal transmission zone. If the signal is weak, adjust the antennas or fly the aircraft closer.

Button Combinations

Some frequently-used features can be activated by using button combinations. To use button combinations, hold the back button and then press the other button.

Checking the Available Button Combinations

Hold the Back button until the controller vibrates to check button combinations:

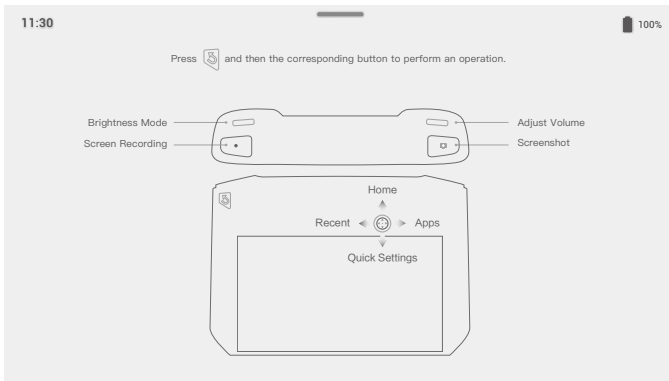

Button Combinations

Using Button Combinations

The functions of the button combinations cannot be changed. The following table displays the function of each button combination.

Button Combinations	Description
Function Button + Reserved Dial (Right Dial)	Adjust the system volume
Function Button + Spray Rate Dial (Left Dial)	Adjust the screen brightness
Function Button + Spray Button	Record the screen
Function Button + FPV / Map Switch Button	Screenshot the screen
Function Button + 5D Button (up)	Return to Homepage
Function Button + 5D Button (down)	Open Quick Settings
Function Button + 5D Button (left)	Check recently opened apps
Function Button + 5D Button (right)	Open App Center

Calibrating the Compass

After the remote controller is used in places with electro-magnetic interference, the compass may need to be calibrated. A warning prompt will appear if the remote controller's compass requires calibration. Tap the warning prompt to start calibrating. In other cases, follow the steps below to calibrate your remote controller.

1. Power on the remote controller.
2. Swipe down from the top of the screen, tap , and scroll down and tap Compass.
3. Follow the diagram on the screen to calibrate your remote controller.
4. The user will receive a prompt when the calibration is successful.

Blocking Third-Party Notifications

To ensure safe flight, it is recommended to disable third-party notifications before each flight. Follow the steps below to disable third-party notifications.





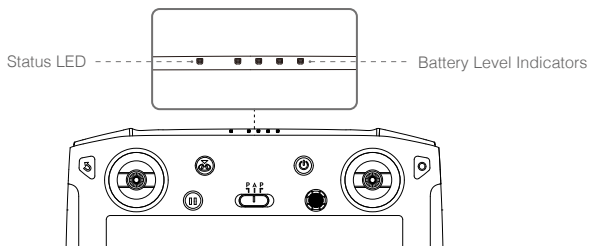











Power on the remote controller. Swipe down from the top of the screen, tap , then Notifications, and enable Do Not Disturb. After this, all the third-party notifications will be displayed in the notification bar only when the DJI Agras app is in use.

Remote Controller LEDs



The battery level indicators display the battery level of the controller. The status LED displays the linking status and warnings for control stick, low battery level, and high temperature.

Status LED	Description
Solid Red	The remote controller is not linked to an aircraft.
Solid Green	The remote controller is linked to an aircraft.
Blinks Blue	The remote controller is linking to an aircraft.
Blinks Red	The temperature of the remote controller is too high or the battery level of the aircraft is low.
Blinks Yellow	The battery level of the remote controller is low.
Blinks Cyan	The control sticks are not centered.

Battery Level Indicators				Battery Level
				75%~100%
				50%~75%
				25%~50%
				0%~25%



Remote Controller Warning Sounds

In scenarios where there is a warning, the remote controller will do so by vibrating and/or beeping. When the controller beeps and the status LED is solid green, this error may be related to the aircraft or flight status, and a warning will appear in DJI Agras. If this error is related to the remote controller, a warning will appear on the screen of the remote controller.

To disable the beeping, power on the remote controller, swipe from the top of the screen, tap , then Sound, and adjust the notification volume.

Linking the Remote Controller

The remote controller is linked to the aircraft by default. Linking is only required when using a new remote controller for the first time. When using the Multi-Aircraft Control function, it is required to link all aircraft to the same remote controller.

1. Power on the remote controller and open DJI Agras. Power on the aircraft.
2. Tap Execute Operation to enter Operation View and tap , then . Tap Single Linking or Multi Linking (if Multi-Aircraft Control is in use), and then tap Starting Linking. The status LED blinks blue and the remote controller beeps twice repeatedly, indicating that the remote controller is ready for linking.
3. Press and hold the power button on the Intelligent Flight Battery for five seconds. The Intelligent Flight Battery LEDs blink in sequence, indicating that the linking is in progress.
4. The Status LED on the remote controller glows solid green if linking is successful. If linking fails, enter linking status again and retry.
5. Repeat Step 3 and 4 to complete linking between all the devices and the remote controller, if Multi Linking is selected. When finished, tap End Linking.

Multi-Aircraft Control Mode

The remote controller features a Multi-Aircraft Control mode, which can be used to coordinate the operation of up to three aircraft simultaneously for greater efficiency. It is recommended for large spray areas. Users can switch control between different aircraft in the app to control individual aircraft.



- Multi-Aircraft Control mode can only be used in Route operation mode. Make sure to complete field planning and related configurations before entering Multi-Aircraft Control mode, since fields cannot be edited in Multi-Aircraft Control mode.
- To avoid interference between operations, do not operate more than three groups within a 50m radius when using Multi-Aircraft Control mode.

Entering Multi-Aircraft Control Mode

1. Link up to three aircraft to the same remote controller according to the steps in Linking the Remote Controller.
2. Close the settings after linking. The linked aircraft are listed on the left of the screen and sorted by number.

Switch Control

Tap the status box of the corresponding number in the app. The upper right corner of its box turns red to indicate the corresponding aircraft is selected. Aircraft that are not selected will have a blue triangle in the upper right corner of its box.

Multi-Aircraft Operations

1. Tap select multiple fields in the Fields tag, and drag the icon for each aircraft with a number to a field to bind the field and aircraft. Set parameter configurations, add connection points if necessary, and start operations.
2. Tap Start after invoking operations for all aircraft. To launch the aircraft individually, move the sliders for each aircraft in the prompt. Move the slider at the bottom of the screen to make all aircraft take off simultaneously.
3. Users can also select each aircraft successively to select a field and operation.
4. If there is any emergency during operation, tap Pause to pause all the Route operations. All aircraft will hover in place and can be controlled manually. Tap Resume to continue operations. Users can push the pitch or roll stick to pause the operation of the selected aircraft without affecting the operations of the other aircraft.
5. If any of the aircraft complete its operation before the others, users can tap "+" in the aircraft status box to add a new operation for the aircraft. Repeat Step 1 to start a new operation if all aircraft have completed their operations.

Multi-Aircraft Usage Notice



- Make sure that obstacle avoidance is enabled to assist the aircraft to avoid each other during operations.
- When using Connection Routing, the planned connection route of each aircraft will only circumvent the obstacles that are included in the field of that aircraft.
- Orchard Configuration operations, prescription maps, and spreading operations are not supported in Multi-Aircraft Control mode.



- In Multi Linking mode, firmware updates and logs are unavailable for aircraft and other devices except for the remote controller.
 - There is a short delay when switching between Single and Multi Linking. Device information in the Linked Aircraft list will be cleared automatically after the switch.
-

Exiting Multi-Aircraft Control Mode

Users can exit from the mode using one of the following three methods.

Method 1: Link the remote controller to a single aircraft. Refer to the Linking the Remote Controller section and follow the instructions for single linking.

Method 2: In the Linked Aircraft list, delete other aircraft and leave a single aircraft. The remote controller will only control this aircraft and can operate using the other operation modes.

Method 3: Power off the aircraft that are not required leaving a single aircraft powered on. The remote controller will only control this aircraft and can operate using the other operation modes. Notes: If the other aircraft are powered on again, the remote controller and the linked aircraft will enter Multi-Aircraft Control mode automatically. Use Method 1 or 2 to exit Multi-Aircraft Control mode completely.

DJI Agras App

DJI Agras is designed for agricultural applications. The app has a clear and concise interface and displays the status of the aircraft, spraying system, and other devices connected to the remote controller, and enables users to configure various settings. After planning a field via the intelligent operation planning system of the app, the aircraft can automatically follow the pre-planned flight route.

Home Screen

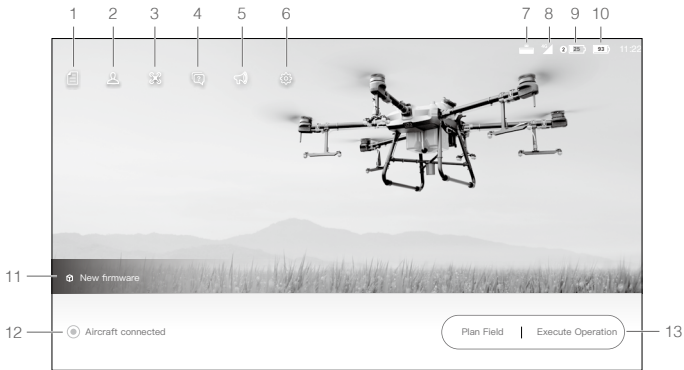

1. Task Management

 : view planned fields, operation progress, and resources such as prescription maps. You can synchronize the local data with the data on the DJI AG platform.

2. User Info

 : view account information.

3. Aircraft Info

 : view the information of the connected aircraft such as the firmware version.

4. Troubleshooting

 : view solutions for errors of each module and upload error logs.

5. Notification Center

 : check notifications about any changes to the aircraft, users, or operations.

6. General Settings

 : tap for settings such as units of measurement, network diagnosis, and Android system settings.

7. Expansion Module Connection Status

 : shows if the remote controller expansion module (used to mount the 4G dongle) is connected.

8. 4G Dongle Signal Strength

 : the icon is displayed if a 4G dongle is mounted. It shows the current signal strength of the 4G dongle.

9. External Battery Level

2 **25** : the icon is displayed if an external battery is mounted. It shows the current battery level of the external battery.

10. Internal Battery Level

93 : shows the current battery level of the internal battery.

11. Firmware Notifications

 : shows the firmware update notifications. Tap to enter the firmware page.

12. Aircraft Connection Status

 : shows if the aircraft is connected to the remote controller.

13. Plan Field | Execute Operation

Plan Field: tap the button and select the planning method to plan a field.

Execute Operation: tap to enter Operation View to view the aircraft status, configure settings, and switch between different operation modes.

Operation View

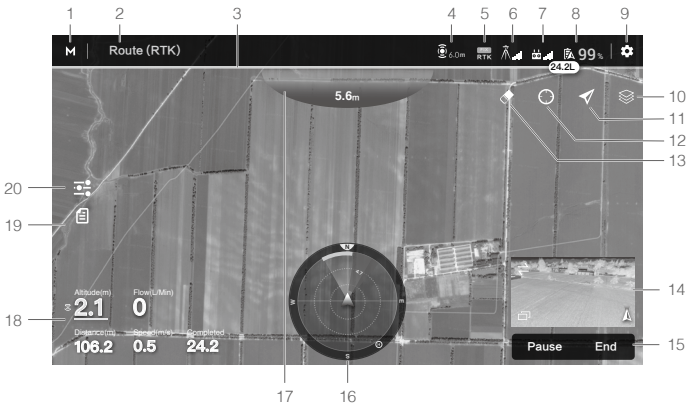

1. Operation Mode Switch Button

M / **M⁺** / **AB**: tap to switch between Manual (M), Manual Plus (M+), and A-B Route (AB) operation modes.

2. System Status

Route (GNSS) : indicates current flight modes, operation modes, and warning messages. Tap to enter Aircraft Health System to view and diagnose each module and upload status logs.

3. Liquid Level Notification

Displays the amount of liquid remaining in the spray tank. It shows a full green progress bar when the remaining liquid amount in the spray tank is sufficient. The green part of the progress bar will reduce gradually as the aircraft sprays. It will turn red when the remaining liquid level nears the threshold of the empty tank warning.

4. Omnidirectional Digital Radar Status

 : shows the status of omnidirectional digital radar and the side obstacle detection distance. Tap to enable or disable the radar and set the side obstacle detection distance in the pop-up menu. When the radar is disabled, only the horizontal obstacle avoidance is disabled. Altitude stabilization is not disabled.

5. RTK/GNSS Signal Strength

 : this icon is displayed when RTK is enabled and works normally. On the upper right corner is the number of satellites connected. One of the following three statuses is displayed above the RTK icon: FIX indicates that the differential data calculation is completed and the aircraft can use RTK for positioning. The aircraft can only take off in this status. FLOAT indicates that the system is calculating the differential data. Wait for FIX to be displayed. SINGLE indicates that the differential data is not obtained. Wait for FIX to be displayed.

 : this icon is displayed when RTK is not in use. It shows the current GNSS signal strength and the number of satellites connected.

6. RTK Connection Status

Icons displayed when using RTK data. The display varies when using the D-RTK 2 or Network RTK Service.

 : displays RTK signal strength when using the D-RTK 2.

 : indicates that the connection with the D-RTK 2 is abnormal. Refer to the prompts in the app.

 : displays RTK signal strength when using the Network RTK Service.

 : indicates that the connection with the Network RTK server is abnormal. Refer to the prompts in the app.

7. Control Signal Strength

 : shows the signal strength of the connection between the aircraft and the remote controller.

8. Battery Settings

 99% : shows the current battery level.

9. More Settings

Tap  to enter the extended menu to view and adjust the parameters of all other settings.

 Aircraft Settings: includes setting the maximum altitude, maximum flight distance, connection routing and RTH speed and altitude, action when tank is empty and operations complete, whether to execute the action when tank is empty at refill point, the aircraft behavior and whether to abort operation when the remote controller signal is lost, home point position, lamp brightness, and also advanced settings.

 Spraying System Settings: includes the spraying system switch as well as setting the spray tank level and empty tank warning threshold, calibrating the pump flow, flow meter, liquid level gauge, and nozzle model, restoring the flow meter to factory settings, and whether to display spraying system data, empty tank and refill points, and flow meter error alerts.

 RC Settings: includes linking and calibrating remote controllers, setting the control stick mode and customizable buttons, and checking information of linked aircraft.

 Radar Settings: includes setting altitude stabilization, horizontal obstacle avoidance, upward obstacle avoidance, auto obstacle avoidance, side obstacle detection distance, obstacle distance display, warning distance, attitude indicator transparency, attitude indicator size, task terrain, and calibrating the detection angle.

RTK RTK Settings: includes aircraft RTK positioning, RTK signal source and the corresponding settings.

HD Image Transfer Settings: includes channel mode and sweep frequency chart selection.

⚡ Aircraft Battery: includes low battery warning threshold, low battery action, and battery information.

••• General Settings: includes map settings, flight route display, and FPV settings.

10. Map Mode

 : tap to switch between Standard, Satellite, or Night modes.

11. Location Follow

Tap to choose if the map display follows the aircraft location.

 : to keep the aircraft centered in the map.

 : to keep the map display fixed regardless of the aircraft location.

12. Location

 : tap to center the map around the location of the aircraft or the latest recorded home point.

13. Clear Screen

 : tap to clear the flight route currently shown on the map.

14. FPV Camera View

Displays the live view from the FPV camera. Tap to switch between the Map View and Camera View. The front FPV camera view is displayed by default. Users can change the display using the icons below.



15. Operation Control Buttons

Used to control the aircraft during different operation types, including measuring an task area and invoking, starting, pausing, or ending an operation.

16. Radar Indicator

Displays information such as the orientation of the aircraft and the Home Point. Shows information on the detected obstacles when the horizontal obstacle avoidance function is enabled. Red, yellow, and green zones indicate the relative distance of the obstacles ranging from near to far. The value indicates the distance in meters or feet depending on the settings.

17. Upward Obstacle Indicator

If upward obstacle avoidance is enabled, a red zone will appear on the top of the screen when an obstacle is detected including the distance from the obstacle.

18. Flight Telemetry and Operation Status

Height: when the altitude stabilization function of the radar module is enabled, it shows the height between the aircraft and the nearest object or ground underneath the aircraft. Tap the value to adjust. If the altitude stabilization function is disabled, it displays the altitude between the aircraft and the takeoff point.

Flow: displays the liquid flow rate.

Distance: displays the horizontal distance from the aircraft to the Home Point.

Speed: displays the flight speed of the aircraft.

Area: displays the area values related to the task area including the following values.

- a. Field Area: displays the value of the total planning area when planning fields for Route operations.
- b. Task Area: displays the value of the actual area of the planned task route after planning the field. The area is planned using the following formula: Task Area = Field Area - Obstacle Area - Safety Margin Zone Area
- c. Obstacle Area: displays the value of the area of obstacles measured when planning fields for Route operations.
- d. Safety Margin Zone Area: displays the value of the area of the safety margin zone if the safety margin is configured when planning fields for Route operations.
- e. Sprayed Area: displays the value of the area already sprayed.

19. Operation List

 : Displayed in M operation mode. Tap to view the planned fields and operations in progress and invoke operations.

20. Parameters Configuration

Tap to adjust operation parameters after entering any operation mode. The adjustable parameters include spray amount, flight speed, route spacing, and the height of the aircraft above the vegetation. The actual parameters that can be adjusted vary depending on the operation mode.

Flight

Operation Environment

1. DO NOT use the aircraft to spray in winds exceeding 18 kph (11 mph).
2. DO NOT use the aircraft in adverse weather conditions such as snow, fog, winds exceeding 28 kph (17 mph), and heavy rain (precipitation rate exceeding 25 mm (0.98 in) in 12 hours).
3. Only fly in open areas. Tall buildings and steel structures may affect the accuracy of the compass and the GNSS signal.
4. Pay attention to utility poles, power lines, and other obstacles. DO NOT fly near or above water, people, or animals.
5. Maintain VLOS of the aircraft at all times, and avoid flying near obstacles, crowds, animals, and bodies of water.
6. Avoid flying in areas with high levels of electromagnetism, including mobile phone base stations and radio transmission towers.
7. DO NOT fly more than 4.5 km (14,763 ft) above sea level.
8. The DJI Agras app will intelligently recommend the payload weight limit for the tank according to the current status and surroundings of the aircraft. Do not exceed the recommended payload weight limit when adding material to the tank. Otherwise, the flight safety may be affected.
9. Make sure that there is a strong GNSS signal and the D-RTK antennas are unobstructed during operation.
10. DO NOT operate the aircraft indoors.

Flight Limits and GEO Zones

Unmanned aerial vehicle (UAV) operators should abide by the regulations from self-regulatory organizations such as the International Civil Aviation Organization, the Federal Aviation Administration, and their local aviation authorities. For safety reasons, flight limits are enabled by default to help users operate this aircraft safely and legally. Users can set flight limits on height and distance.

When operating with a strong GNSS signal, the height and distance limits and GEO zones work together to monitor flight. With a weak GNSS signal, only the height limit prevents the aircraft from going above 100 meters.

Maximum Height and Radius Limits

Users can change the maximum height and radius limits in the app. Once completed, the aircraft flight is restricted to a cylindrical area that is determined by these settings. The tables below show the details of these limits.

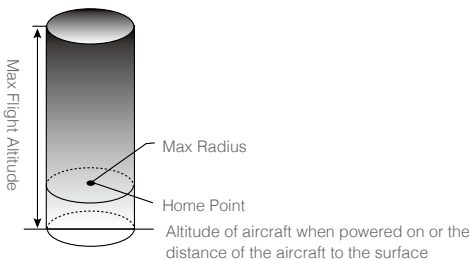

With a strong GNSS signal

Flight Limits

Max Height	Flight altitude must be below the preset height.
Max Radius	Flight distance must be within the max radius.

With a weak GNSS signal

Flight Limits

Max Height	Flight altitude must be below the preset height.
Max Radius	No limit.



- If the aircraft flies into a Restricted Zone, it can still be controlled, but the aircraft can only fly in a backward direction.
- If the aircraft loses GNSS signal and flies out of the max radius but regains GNSS signal later, it will fly back within range automatically.



GEO Zones

GEO zones are divided into different categories. All GEO zones are listed on the DJI official website at <http://www.dji.com/flysafe>.

GEO zones are explained below (GNSS required):

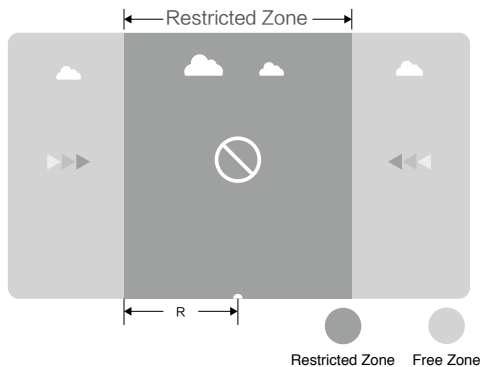
Depending on the local regulation, a certain radius around a marker forms a Restricted Zone, inside of which takeoff and flight are prohibited.



With a strong GNSS signal	
Area	Restriction
Restricted Zone 	Motors will not start. If the aircraft loses GNSS signal and enters a Restricted Zone but regains GNSS signal later, the aircraft will enter semi-automatic descent after a countdown and land.
No Flight Restrictions 	Users can fly their aircraft freely.

 Semi-Automatic Descent: All stick commands except the throttle stick command are available during descent and landing. Motors automatically stop after landing.

 DO NOT fly near airports, highways, railway stations, railway lines, city centers, or other busy areas. Make sure the aircraft is visible at all times.

Pre-Flight Checklist

1. Make sure the remote controller and aircraft battery are fully charged. The pesticides required are adequate.
2. Make sure the spray tank and Intelligent Flight Battery are firmly in place.
3. Make sure all parts are mounted securely.
4. Make sure all cables are connected properly and firmly.
5. Make sure propellers are securely mounted, that there are no foreign objects in or on the motors and propellers, that the propeller blades and arms are unfolded, and the arm locks are firmly tightened.
6. Make sure the spraying system is not blocked in any way.
7. Make sure the sprinkler hoses are clear from bubbles. Discharge any bubbles as they may affect the performance of the sprinkler. Press and hold the spray button for two seconds to start the automatic bubbles discharge function to spray the bubbles.

Discharging Trapped Air in the Hoses

The T30 features an automatic trapped air discharge function. When it is necessary to discharge trapped air, start the function through one of the two methods below. The aircraft will discharge automatically until the trapped air is fully discharged.

1. Press and hold the spray button for two seconds.
2. Enter Operation View, tap , then , and tap Start on the right of the Clear Trapped Air section.



Calibrating the Flow Meter

Make sure to calibrate the flow meter before using for the first time. Otherwise, the spraying performance may be adversely affected.



1. Preparation

- ① Fill the spray tank with approximately 2 L of water.
- ② Use the automatic trapped air discharge function to discharge the trapped air. Users can also manually discharge the trapped air. Press the spray button to spray the trapped air and press the button again once all trapped air is discharged.



2. Calibration

- ① In the app, tap Execute Task to enter Operation View. Tap , then , swipe up, and tap Calibration on the right of the flow meter calibration section.
- ② Tap Start Calibration to begin. Calibration will be complete after 25 seconds and the results are displayed in the app.
 - Users can proceed once calibration is completed successfully.
 - If calibration fails, tap “?” to view and resolve the problem. Recalibrate once the problem is resolved.



During calibration, tap , then  to cancel. If the calibration is cancelled, the accuracy of the flow meter is based on the data before the calibration was started.

When to Recalibrate



1. Installing a different nozzle model. Note: Choose the corresponding model in the app after replacing nozzles. Go to Operation View, tap , then  for configuration.
2. Using a liquid of a different viscosity.
3. The error between the actual value and the theoretical value of the completed area is more than 15%.

Calibrating the Compass



- It is important to calibrate the compass. The calibration result affects the flight safety. The aircraft may malfunction if the compass is not calibrated.
- DO NOT calibrate the compass where there is a chance of strong magnetic interference. This includes areas where there are utility poles or walls with steel reinforcements.
- DO NOT carry ferromagnetic materials with you during calibration such as keys or mobile phones.
- If the aircraft status indicators show a blinking red light, compass calibration has failed. Please recalibrate.
- After calibrating successfully, the compass may be abnormal when you place the aircraft on the ground. This may be because of underground magnetic interference underground. Move the aircraft to another location and try again.

Calibrate the compass when prompted by the app. It is recommended to calibrate the compass with an empty tank

1. Tap , then , move the slider to the bottom, and select Advanced Settings, then IMU and Compass Calibration. Tap Calibration in the compass calibration section.

2. Hold the aircraft horizontally and rotate it 360° around a vertical axis with the aircraft approximately 1.2 m above the ground. Calibration is completed when the app displays that calibration was successful.
3. If the app displays a tilted aircraft, it indicates that the horizontal calibration failed. Users should tilt the aircraft and rotate it horizontally. Calibration is completed when the app displays that calibration was successful. To reduce the number of rotations required, the aircraft should be tilted at least 45°.

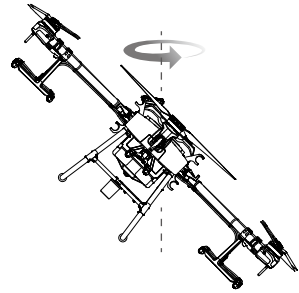
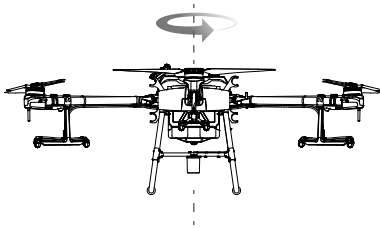

4. If calibration continues to fail, recalibrate the compass from Step 1.

Starting and Stopping the Motors

Starting the Motors

The Combination Stick Command (CSC) listed below is used to start and stop the motors. Make sure you perform the CSC in one continuous motion. The motors begin to accelerate at an idle speed. Release both sticks simultaneously. Take off immediately once the motors are spinning, or else the aircraft may lose balance, drift, or even takeoff by itself and risk causing damage or injury.



Stopping the Motors

There are two methods to stop the motors.

1. When the aircraft has landed, push and hold the throttle stick down. The motors will stop after three seconds.



Throttle Stick (left stick in Mode 2)

- When the aircraft has landed, push the throttle stick down, and perform the same CSC that was used to start the motors. Release both sticks once the motors have stopped. Release both sticks once the motors have stopped.

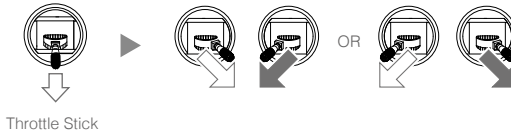

- ⚠
- Spinning propellers can be dangerous. Stay away from spinning propellers and motors. DO NOT start the motors in confined spaces or when there are people nearby.
 - Keep your hands on the remote controller when the motors are spinning.
 - DO NOT stop the motors mid-flight unless in an emergency situation where doing so will reduce the risk of damage or injury.
 - Method 1 is the recommended method for stopping the motors. When using Method 2 to stop the motors, the aircraft may roll over if it is not completely grounded. Use Method 2 with caution.
 - After landing, power off the aircraft before powering off the remote controller.

Flight Test

- Place the aircraft on open, flat ground with the aircraft status indicators facing toward you.
- Pour liquid into the spray tank, and tighten the cover. Make sure that the four lines on the cover are aligned to the horizontal or vertical direction.

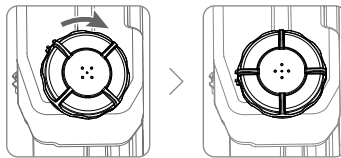

- Power on the remote controller, make sure that DJI Agras is open, and then power on the aircraft.
- Make sure that the aircraft is connected to the remote controller.
- If using RTK for positioning, make sure that the aircraft RTK positioning function is enabled and RTK signal source is correctly set (D-RTK 2 Mobile Station or Network RTK service). Go to Operation View in the app, tap and select RTK to view and set.

Make sure to disable the aircraft RTK positioning function if it is not in use. Otherwise, the aircraft is not be able to take off when there is no differential data.

- Wait for satellites to be searched, make sure that there is a strong GNSS signal, and make sure the aircraft heading measurement using the dual antennas is ready. Perform the CSC to start the motors. (If the dual antennas are not ready after waiting for an extended period, move the aircraft to an open area with a strong GNSS signal.)
- Push the throttle stick up to take off.

8. Select the desired operation or flight mode and start operation.
9. Exit the operation to manually control the aircraft for landing. Hover over a level surface and gently pull down on the throttle stick to slowly descend.
10. After landing, push the throttle down and hold. The motors stop after three seconds.
11. Power off the aircraft, and then power off the remote controller.

 When the low battery warning prompt appears in the app, fly the aircraft to a safe area and land as soon as possible. Stop the motors and replace the battery. The aircraft will automatically descend and land when the critical low battery warning prompt appears in the app.

DJI Assistant 2 for MG

Configure settings of the basic parameters, copy flight records, and update aircraft and remote controller firmware in DJI Assistant 2 for MG.

Installation and Launching

1. Download the DJI Assistant 2 for MG installation file from the T30 download page:
<https://www.dji.com/t30/downloads>
2. Install the software.
3. Launch DJI Assistant 2 for MG.

Using DJI Assistant 2 for MG

Connecting the Aircraft

Connect the USB-C port on the bottom of the aircraft to a computer with a USB-C cable, and then power on the aircraft.

 Make sure to remove the propellers before using DJI Assistant 2 for MG.

 Remove the waterproof cover on the USB-C port before use. Attach the waterproof cover to the port after use. Otherwise, water may enter the port, causing it to short circuit.

Firmware Update

A DJI account is required for firmware updates. Login or register an account.

Exporting Log

View all the logs of the aircraft and select logs to export.

Simulator

Click Open to enter the flight simulation view. Input location and environment parameters and click Configure to save. Click Start Simulation to enter flight simulation practice.

Basic Settings

Configure the idle speed of and test the motor.

Connecting the Remote Controller

1. Connect the USB-C port of the remote controller to a computer with a USB A to A cable, and then power on the remote controller.
2. Swipe from the top of the screen, and make sure that the USB option is enabled.

Firmware Update

A DJI account is required for firmware updates. Login or register an account.

Exporting Log

View all the logs of the remote controller and select the logs to export.

-
-  • DO NOT power off the remote controller during the update.
- DO NOT perform the firmware update while the aircraft is in the air. Only carry out the firmware update when the aircraft is on the ground.
- The remote controller may become unlinked from the aircraft after the firmware update. Relink the remote controller and aircraft if necessary.
-

Appendix

Specifications

Product Model	3WWDZ-30A
Airframe	
Max Diagonal Wheelbase	2145 mm
Dimensions	2858×2685×790 mm (arms and propellers unfolded) 2030×1866×790 mm (arms unfolded and propellers folded) 1170×670×857 mm (arms and propellers folded)
Propulsion System	
Motors	
Max Power	3600 W/rotor
ESCs	
Max Working Current (Continuous)	60 A
Foldable Propellers (R3820)	
Diameter × Pitch	38×20 in
Spraying System	
Spray Tank	
Volume	Fully loaded: 30 L
Operating Payload	Fully loaded: 30 kg
Nozzles	
Model	XR11001VS (standard), XR110015VS (optional, purchase separately), TX-VK4/ZX-VK4 (optional for Orchard Configuration, purchase separately)
Quantity	16
Max Spray Rate	XR11001VS: 7.2 L/min, XR110015VS: 8 L/min
Spray Width	4-9 m (12 nozzles, at a height of 1.5-3 m above crops)
Droplet Size	XR11001VS: 130-250 µm, XR110015VS: 170-265 µm (subject to operating environment and spray rate)
Flow Meter	
Measurement Range	0.25-20 L/min
Error	<±2%
Measurable Liquid	Conductivity >50 µS/cm (liquids such as tap water or pesticides that contain water)
Omnidirectional Digital Radar	
Model	RD2424R
Operating Frequency	SRRC/NCC/FCC/MIC/KCC/CE: 24.05-24.25 GHz
Power Consumption	12 W
Transmission Power (EIRP)	SRRC: ≤13 dBm, NCC/MIC/KCC/CE/FCC: ≤20 dBm
Altitude Detection & Terrain Follow ¹⁾	Altitude detection range: 1-30 m Stabilization working range: 1.5-15 m Max slope in Mountain mode: 35°

Obstacle Avoidance ¹¹	<p>Obstacle sensing range: 1.5-30 m</p> <p>FOV: Horizontal: 360°, Vertical: ±15°</p> <p>Working conditions: flying higher than 1.5 m over the obstacle at a speed lower than 7 m/s</p> <p>Safety limit distance: 2.5 m (distance between the front of propellers and the obstacle after braking)</p> <p>Obstacle avoidance direction: omnidirectional obstacle avoidance in the horizontal direction</p>
----------------------------------	--

IP Rating	IP67
-----------	------

Upward Radar

Model	RD2414U
Operating Frequency	SRRC/NCC/FCC/MIC/KCC/CE: 24.05-24.25 GHz
Power Consumption	4 W
Transmission Power (EIRP)	SRRC: ≤13 dBm, NCC/MIC/KCC/CE/FCC: ≤20 dBm
Obstacle Avoidance ¹¹	<p>Obstacle sensing range: 1.5-15 m</p> <p>FOV: 80°</p> <p>Working conditions: available during takeoff, landing, and ascending when an obstacle is more than 1.5 m above the aircraft.</p> <p>Safety limit distance: 2 m (distance between the highest point of the aircraft and the lowest point of the obstacle after braking)</p> <p>Obstacle avoidance direction: upward</p>
IP Rating	IP67

FPV Cameras

FOV	Horizontal: 129°, Vertical: 82°
Resolution	1280×720 15-30fps
FPV Spotlights	FOV: 120°, Max brightness: 13.2 lux at 5 m of direct light

Flight Parameters

Operating Frequency	SRRC/NCC/FCC/CE/MIC/KCC: 2.4000-2.4835 GHz SRRC/NCC/FCC/CE: 5.725-5.850 GHz ²¹
Transmission Power (EIRP)	2.4 GHz SRRC/CE/MIC/KCC: ≤20 dBm, FCC/NCC: ≤31.5 dBm 5.8 GHz FCC/SRRC/NCC: ≤29.5 dBm, CE: ≤14 dBm
Total Weight (exc. battery)	26.3 kg
Max Takeoff Weight	Max takeoff weight for spraying: 66.5 kg (at sea level) Max takeoff weight for spreading: 78 kg (at sea level)
Hovering Accuracy Range (with strong GNSS signal)	D-RTK enabled: Horizontal: ±10 cm, Vertical: ±10 cm D-RTK disabled: Horizontal: ±0.6 m, Vertical: ±0.3 m (Radar module enabled: ±0.1 m)
RTK/GNSS Operating Frequency	RTK: GPS L1/L2, GLONASS F1/F2, BeiDou B1/B2, Galileo E1/E5 GNSS: GPS L1, GLONASS F1, Galileo E1
Battery	DJI-approved flight battery (BAX501-29000mAh-51.8V)
Max Power Consumption	13000 W
Hovering Time ²³	20.5 min (takeoff weight of 36.5 kg with an 29000 mAh battery) 7.8 min (takeoff weight of 66.5 kg with an 29000 mAh battery)
Max Tilt Angle	15°

Max Operating Speed	7 m/s
Max Flying Speed	10 m/s (with strong GNSS signal)
Max Wind Resistance	8 m/s
Max Service Ceiling Above Sea Level	4500 m
Recommended Operating Humidity	<93%
Recommended Operating Temperature	0° to 45° C (32° to 113° F)

Remote Controller

Model	RM500-ENT
Screen	5.5-in screen, 1920x1080, 1000 cd/m ² , Android system
RAM	4GB
Built-in Battery	18650 Li-ion (5000 mAh @ 7.2 V)
GNSS	GPS+GLONASS
Power Consumption	18 W
Operating Temperature	0° to 45° C (32° to 113° F)
Charging Environment Temperature	5° to 40° C (41° to 104° F)
Storage Temperature	< 1 month: -30° to 60° C (-22° to 140° F) 1 - 3 months: -30° to 45° C (-22° to 113° F) 3 - 6 months: -30° to 35° C (-22° to 95° F) > 6 months: -30° to 25° C (-22° to 77° F) (Built in battery power 40% - 60%)

OcuSync Enterprise

Operating Frequency	SRRC/NCC/FCC/CE/MIC/KCC: 2.4000-2.4835 GHz SRRC/NCC/FCC/CE: 5.725-5.850 GHz ^[2]
Max Transmission Distance (Unobstructed, free of interference)	FCC/NCC: 7 km, SRRC: 5 km, MIC/KCC/CE: 4 km
Transmission Power (EIRP)	2.4 GHz SRRC/CE/MIC/KCC: ≤20 dBm, FCC/NCC: ≤30.5 dBm 5.8 GHz SRRC: ≤21.5 dBm, FCC/NCC: ≤29.5 dBm, CE: ≤14 dBm

Wi-Fi

Protocol	Wi-Fi Direct, Wi-Fi Display, 802.11a/g/n/ac Wi-Fi with 2x2 MIMO
Operating Frequency	2.4000-2.4835 GHz 5.150-5.250 GHz ^[2] 5.725-5.850 GHz ^[2]
Transmission Power (EIRP)	2.4 GHz SRRC/CE: 18.5 dBm, NCC/FCC /MIC/KCC: 20.5 dBm 5.2 GHz SRRC/NCC/FCC/CE/MIC: 14 dBm, KCC: 10 dBm 5.8 GHz SRRC/NCC/FCC: 18 dBm, CE/KCC: 12 dBm

Bluetooth

Protocol	Bluetooth 4.2
Operating Frequency	2.4000-2.4835 GHz
Transmission Power (EIRP)	SRRC/NCC/FCC/CE/MIC/KCC: 6.5 dBm

Remote Controller Intelligent Battery

Model	WB37-4920mAh-7.6V
Battery Type	2S LiPo
Capacity	4920 mAh
Voltage	7.6 V
Energy	37.39 Wh
Charging Environment Temperature	5° to 40° C (41° to 104° F)

Intelligent Battery Charging Hub











Model	WCH2
Input Voltage	17.3-26.2 V
Output Voltage and Current	8.7 V, 6 A
Operating Temperature	5° to 40° C (41° to 104° F)

AC Power Adapter

Model	A14-057N1A
Input Voltage	100-240 V, 50/60 Hz
Output Voltage	17.4 V
Rated Power	57 W

- [1] The effective radar range varies depending on the material, position, shape, and other properties of the obstacle.
- [2] Local regulations in some countries prohibit the use of the 5.8 and 5.2 GHz frequencies. In some countries, the 5.2 GHz frequency band is only allowed for indoor use.
- [3] Hovering time acquired at sea level with wind speeds lower than 3 m/s.

Aircraft Status Indicators Description

Blinking Patterns	Description
 Blink red, green, and yellow	Self-checking
 ×4 Blink yellow four times	Warning up
 Blink yellow slowly	A-mode (no GNSS)
 Blink green slowly	P-mode (GNSS)
 Blink green rapidly	When an obstacle is detected, the aircraft breaks and hovers to enter obstacle avoidance mode.
 Blink yellow and green alternately	RTK dual antenna is not ready.
 Blink red and green alternately	RTK function is enabled, but RTK positioning is not ready.
 — Solid red	System error. Restart the aircraft, and if still not working, contact DJI Support or a DJI authorized dealer.
 Blink red and yellow alternately	Abnormal compass data. Compass calibration required.
 Blink yellow rapidly	Remote controller signal lost.

Updating the Firmware

The firmware of the remote controller, aircraft, and other devices such as the battery station can be updated together in DJI Agras. Follow the steps below.

1. Power on the remote controller and the aircraft. Make sure that the remote controller has access to the internet via Wi-Fi or a dongle. The firmware file is usually large. It is recommended to use Wi-Fi.
2. A prompt appears at the bottom of the home screen in DJI Agras when a new firmware update is available. Tap the prompt to enter the firmware screen.
3. Connect the device to the USB-A port on the remote controller to update the firmware of the battery station. Tap the dropdown menu for each device and select the firmware. There will be a check mark on the device displayed in the app when a firmware is selected for the corresponding device. Uncheck the mark to cancel the update.
4. Tap Update All to redirect to the update screen. The app will download the firmware for all selected devices and update automatically.
5. Make sure all the devices are connected to the remote controller and wait for the update to complete.
6. After successfully completing the update, restart the remote controller and the aircraft manually.

DJI Assistant 2 for MG can also be used to update the firmware. Refer to [DJI Assistant 2 for MG \(p. 55\)](#) for more information.

DJI Support

<http://www.dji.com/support>

This content is subject to change without prior notice.

Download the latest version from

<http://www.dji.com/t30>

If you have any questions about this document, contact DJI by sending a message to DocSupport@dji.com.

Copyright © 2021 DJI All Rights Reserved.