

# AGRAS T40 (Type: DJI-3WWDZ-40A)

# AGRAS T20 P (Type: DJI-3WWDZ-20A)

## Unmanned Aircraft Flight Manual

v1.4 2023.07

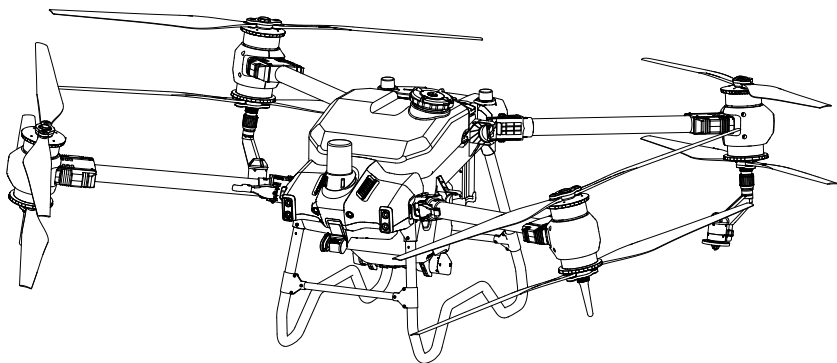
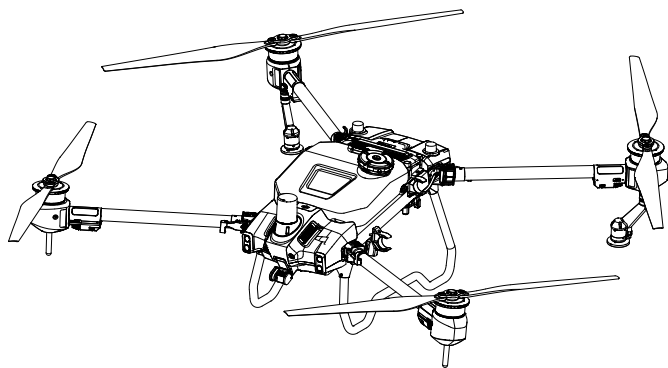



This document is copyrighted by DJI with all rights reserved. Unless otherwise authorized by DJI, you are not eligible to use or allow others to use the document or any part of the document by reproducing, transferring or selling the document. Users should only refer to this document and the content thereof as instructions to operate DJI UAV. The document should not be used for other purposes.

### **Searching for Keywords**

Search for keywords such as “battery” and “install” to find a topic. If you are using Adobe Acrobat Reader to read this document, press Ctrl+F on Windows or Command+F on Mac to begin a search.

### **Navigating to a Topic**

View a complete list of topics in the table of contents. Click on a topic to navigate to that section.

### **Printing this Document**

This document supports high resolution printing.

## **Record of Manual Revisions**

Version	Date	Revisions
v1.0	2022.08	Initial release
v1.2	2022.12	Added FAR Remote ID Compliance Information.
v1.4	2023.07	Updated droplet size.

---

 The T40 aircraft and T20P aircraft have similar functions and operations. Unless otherwise specified, descriptions in this document use the T40 aircraft as an example and apply to both aircraft models.

---

## Information

The aircraft may not come with a flight battery in certain regions. Only purchase official DJI™ flight batteries. Read the corresponding Intelligent Flight Battery user guide and take necessary precautions when handling the batteries to ensure your own safety. DJI assumes no liability for damage or injury incurred directly or indirectly from misusing batteries.

## Using This Manual

### Legend

 Important

 Hints and tips

 Reference

### Before Flight

The following documents have been produced to help you safely operate and make full use of your aircraft:

1. In the Box
2. Disclaimer and Safety Guidelines
3. Quick Start Guide
4. User Manual (Unmanned Aircraft Flight Manual)

Refer to the corresponding in the box to check the listed parts and read the disclaimer and safety guidelines before flight. Refer to the quick start guide for more information on assembly and basic operation. Refer to the user manual for more comprehensive information.

### Downloading DJI Assistant 2 for MG

Download DJI ASSISTANT™ 2 for MG from:

<https://www.dji.com/t40/downloads> or <https://www.dji.com/t20p/downloads>

---

 The operating temperature of this product is 0° to 45° C (32° to 113° F). It does not meet the standard operating temperature for military grade application (-55° to 125° C (-67° to 257° F)), which is required to endure greater environmental variability. Operate the product appropriately and only for applications that it meets the operating temperature range requirements of that grade.

---

# Table of Contents

<b>General Information and System Description</b>	4
Introduction	4
Aircraft	5
Control Station	12
Command and Control Link	26
Ground Operational Area Setup	26
<b>Performance and Limitations</b>	27
Performance	27
Prohibited Maneuvers	28
Center of Gravity Limitations	28
Applicable Environmental Limitations	31
<b>Normal Procedures</b>	32
Airspace Environment	32
Radio Frequency Environment	35
Use of Launch and Recovery Equipment	35
Distance to Control Station	35
System Assembly	36
Pre-Flight Checklist	38
<b>System Starting</b>	39
<b>Calibrating the Flow Meter</b>	39
Calibrating the Compass	40
Takeoff/Landing	40
Cruise / Maneuvering Flight	42
System Shutdown	51
Post-Flight Inspection	51
<b>Emergency Procedures</b>	52
General Information	52
Engine Failure	52
Fire	52
Loss of C2 Link	52
Loss of Navigation Systems	54
Control Station Failures	54
Flyaway	54
Reporting Requirements	54

<b>Weight and Balance and Equipment List</b>	55
<b>Handling, Servicing and Instructions for Maintenance and Continued</b>	
<b>Airworthiness</b>	55
Ground Handling	55
Disassembly, Storage, and Reassembly	55
Charging / Conditioning / Replacing Batteries	59
Maintenance Program	60
<b>Supplements</b>	62
<b>Specifications</b>	62
Operation Resumption	70
System Data Protection	72
Empty Tank Warning	72
Return to Home (RTH)	73
Low Battery and Low Voltage Warnings	74
RTK Functions	74
Aircraft LEDs	75
Updating the Firmware	75
DJI Assistant 2 for MG	76
Intelligent Flight Battery	77
Payload - Spraying System	83
Optional Payload - T40/T20P Spreading System	83
T40/T20P Drone Recommended Maintenance Cycle	86
FAR Remote ID Compliance Information	89

# General Information and System Description

## Introduction

The Agras T40 and Agras T20P have a truss-style design with arms that can be folded to reduce the body size, making the aircraft easier to transport. The all-new integrated spraying system can quickly be swapped with a spreading system. The spreading payload of the T40 has increased to 50 kg for more efficient spreading.

The spatial intelligent sensing system includes active phased array radars and binocular vision to ensure flight safety. Boasting a 12MP UHD FPV camera with a tiltable gimbal, the aircraft can automatically collect HD field images for local offline reconstruction to assist in precise field planning. Using the P4 Multispectral and DJI Agras Intelligent Cloud, prescription maps can be generated in order to perform variable rate fertilization.

The spraying system is equipped with the brand new magnetic drive impeller pumps, dual atomized sprinklers, and anti-drip centrifugal valves. When used with the weight sensors, the spraying system provides real-time liquid level detection and improves spraying efficiency while saving liquid pesticide.

Core modules adopt potting technology and the aircraft has a protection rating of IPX6K (ISO 20653:2013) so that the aircraft body can be washed directly with water.

The next generation DJI RC Plus remote controller features DJI O3 Agras, the latest version of the signature OCUSYNC™ image transmission technology, and has a max transmission distance of up to 7 km (at an altitude of 2.5 m).<sup>[1]</sup> The remote controller has a high-performance 8-core CPU and a built-in 7-in high brightness touchscreen powered by the Android operating system. Users can connect to the internet via Wi-Fi or the DJI Cellular Dongle. Operations are more convenient and accurate than ever before thanks to the revamped DJI Agras app design and a wide range of buttons on the remote controller. With Mapping mode added to the app, users can complete offline reconstructions and perform precise field planning without the need of extra devices. The remote controller has a maximum operating time of 3 hours and 18 min with the high-capacity internal battery. Users can also purchase an external battery separately to be used to supply power to the remote controller and fully meet the requirements for long and high-intensity operations.

[1] The remote controller is able to reach its maximum transmission distance (FCC/NCC: 7 km (4.35 mi); SRRC: 5 km (3.11 mi); CE/KCC/MIC: 4 km (2.49 mi)) in an open area with no electromagnetic interference, and at an altitude of approximately 2.5 m (8.2f t).

## Aircraft

### Feature Highlights

The aircraft has a truss-style body with arms that can be quickly folded, making it easy for transportation. Folding detection sensors built into the frame arms enable the aircraft to perform a folding mechanism self-check, ensuring the arms are properly unfolded. The aircraft supports centimeter-level positioning <sup>[1]</sup> when used with the onboard D-RTK™.

Thanks to the spatial intelligent sensing system with the binocular vision system, active phased array omnidirectional radar, and active phased array backward and downward radar, the aircraft can achieve comprehensive obstacle sensing and terrain following to ensure flight safety as well as improve operation efficiency.

In the new Mapping operation mode, images in the task area can be captured using the UHD FPV camera, and local maps can be generated using the remote controller without internet connection to assist in precise planning.

In the new Fruit Tree operation mode, operations imported in multiple methods can be displayed together for users to start operations more efficiently.

The dual atomized spraying system is equipped with the brand new magnetic drive impeller pump, making the system more corrosion-resistant and durable. The dual atomized sprinkler and proprietary centrifugal valve prevent leakage and reduce pesticide use while protecting the environment.

The T40 aircraft is equipped with a coaxial twin-rotor structure to produce strong winds so that pesticides can penetrate thick canopies for thorough spraying.

Aircraft and operation control is more convenient than ever, thanks to a wide range of buttons and dials on the DJI RC Plus remote controller. With the built-in revamped DJI Agras app, the payload for each flight is maximized through intelligent route planning for greater efficiency.

[1] Must be used with a DJI D-RTK 2 High Precision GNSS Mobile Station (sold separately) or a DJI-approved Network RTK service.

### Aircraft Overview

T40

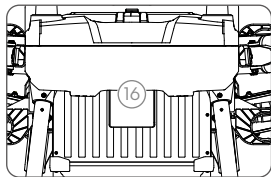
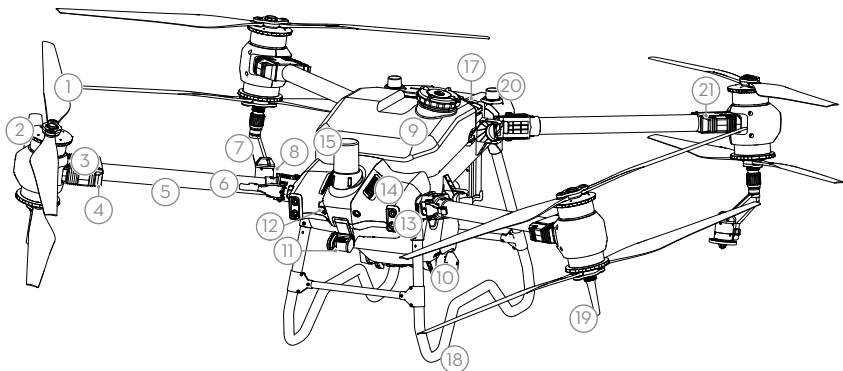

Rear View

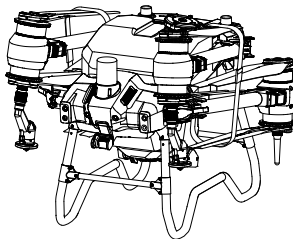

Folded

- |   |   |  |
|---|---|--|
| 1. Propellers                                       | 10. Delivery Pumps  | 18. Landing Gear                                   |
| 2. Motors   | 11. FPV Camera  | 19. OcuSync Image<br>Transmission Antennas         |
| 3. ESCs   | 12. Binocular Vision System                               | 20. Onboard D-RTK<br>Antennas                      |
| 4. Aircraft Front Indicators<br>(on two front arms) | 13. Spotlights  | 21. Aircraft Rear Indicators<br>(on two rear arms) |
| 5. Frame Arms                                       | 14. Heat Sinks  |  |
| 6. Folding Detection Sensors<br>(built-in)          | 15. Active Phased Array<br>Omnidirectional Radar          |  |
| 7. Spray Lance                                      | 16. Active Phased Array<br>Backward and<br>Downward Radar |  |
| 8. Sprinklers                                       | 17. Intelligent Flight Battery                            |  |
| 9. Spray Tank                                       |   |  |



T20P

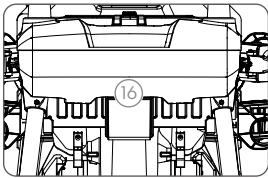
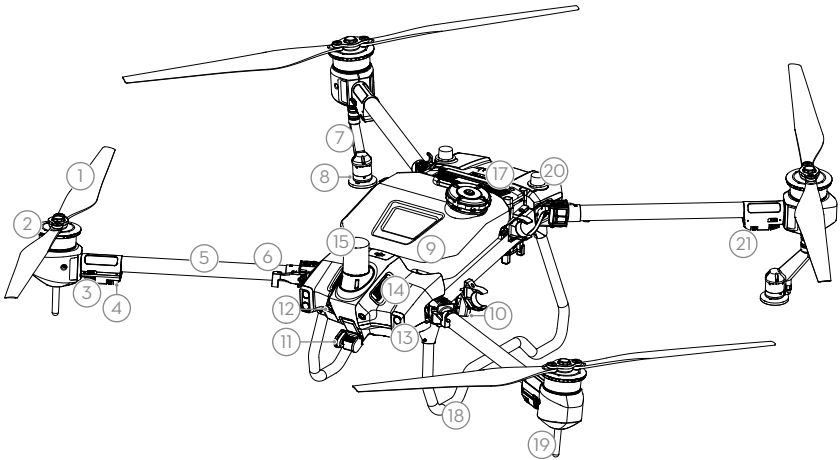

Rear View

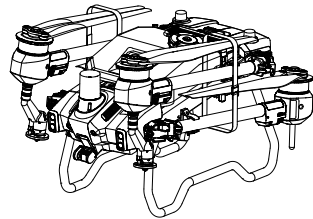

Folded

- |   |   |  |
|---|---|--|
| 1. Propellers                                       | 10. Delivery Pumps  | 18. Landing Gear                                   |
| 2. Motors   | 11. FPV Camera  | 19. OcuSync Image<br>Transmission Antennas         |
| 3. ESCs   | 12. Binocular Vision System                               | 20. Onboard D-RTK<br>Antennas                      |
| 4. Aircraft Front Indicators<br>(on two front arms) | 13. Spotlights  | 21. Aircraft Rear Indicators<br>(on two rear arms) |
| 5. Frame Arms                                       | 14. Heat Sinks  |  |
| 6. Folding Detection<br>Sensors (built-in)          | 15. Active Phased Array<br>Omnidirectional Radar          |  |
| 7. Spray Lance                                      | 16. Active Phased Array<br>Backward and Downward<br>Radar |  |
| 8. Sprinklers                                       | 17. Intelligent Flight Battery                            |  |
| 9. Spray Tank                                       |   |  |

## Flight Control Surfaces

Not applicable for multicopters.

## Propulsion System

The propulsion system consists of motors, ESCs, and folding propellers, to provide stable and powerful thrust.

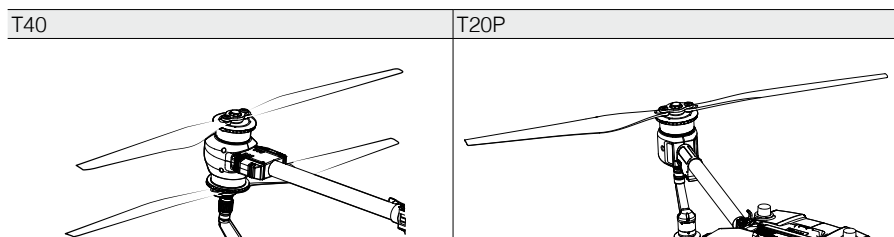

## Avionics

The avionics includes an aerial-electronics system, image transmission system, binocular vision and radar system, spraying control board, and FPV module.

### Flight Control and Navigation System

The flight control and navigation system built into the aircraft is integrated with modules such as the flight controller, IMU, barometer, GNSS receiver, RTK module, and compass, providing stable and reliable navigation and control. The dedicated industrial flight controller provides multiple flight modes and operation modes for various applications. The GNSS+RTK dual-redundancy system is compatible with GPS, GLONASS, BeiDou, and Galileo. The aircraft also supports centimeter-level positioning when used with the built-in onboard D-RTK antennas. Dual-antenna technology provides strong resistance against magnetic interference.

### Communications Equipment

The aircraft boasts two OcuSync image transmission antennas and DJI O3 Agras image transmission system, offering a maximum transmission range of 7 km for communication with the remote controller.

### FPV Module

Equipped with the UHD FPV camera with a tiltable gimbal, the aircraft can automatically collect HD field images for local offline reconstruction to assist in precise field planning. Furthermore, the bright spotlights double the night vision capabilities of the aircraft, creating more nighttime operation possibilities.

### Binocular Vision and Phased Array Radar (Detection and Obstacle Avoidance System)

#### Profile

The aircraft spatial intelligent sensing system consists of the binocular vision system, active phased array omnidirectional radar, and active phased array backward and downward radar. In an optimal operating environment, the radar module can predict the distance between the aircraft and the vegetation or other surfaces in forward, backward, and downward directions to fly at a constant distance and ensure even spraying and terrain following. The system can detect obstacles in all horizontal directions as well as upward and backward to ensure flight safety. In addition, the flight control system limits the descent speed of the aircraft according to the distance between the aircraft and ground detected by the radar modules to achieve a smooth landing.

The binocular vision system is enabled automatically when the aircraft is in use. Terrain follow and bypassing functions need to be enabled in the app before use. In Route and A-B Route operation modes, users can enable the terrain follow and bypassing functions for different terrain types. The aircraft will fly above the vegetation at a constant spraying distance and bypass detected obstacles. When task terrain is set to Mapping/Field on Flatland, bypassing can be enabled or disabled independently. In Manual Plus and Mapping operation modes, select Mapping/Field on Flatland as the task terrain and enable Auto Terrain Follow. The aircraft will achieve terrain follow. In Manual and Fruit Tree operation modes, the radar can measure the spraying distance above the vegetation or other surfaces, but the aircraft will not use the data for altitude stabilization. Obstacle avoidance can be used in any mode.

### Detection Range

Binocular vision system: 90° (horizontal), 106° (vertical), 0.4-25 m.

Active phased array omnidirectional radar: 360° (horizontal), ±45° (vertical), 1.5-50 m.

Active phased array backward and downward radar: ±60° (horizontal), ±25° (vertical), 1.5-30 m (backward), 1-45 m (downward).

Note that the aircraft cannot sense obstacles that are not within its detection range. Fly with caution.

### Detection Range of Binocular Vision System and Radars (Vertical)

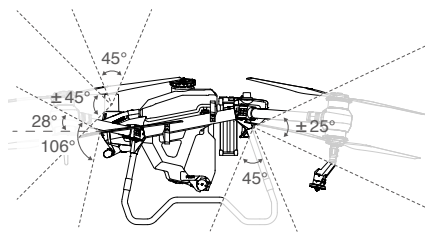

- ⚠ • The effective detection range varies depending on the size and material of the obstacle. When sensing objects such as buildings that have a radar cross section (RCS) of more than -5 dBsm, the effective detection range is 50 m. When sensing objects such as power lines that have a RCS of -10 dBsm, the effective detection range is approximately 30 m. When sensing objects such as dry tree branches that have a RCS of -15 dBsm, the effective detection range is approximately 20 m. Obstacle sensing may be affected or unavailable in areas outside of the effective detection distance.
- Fly with caution when the aircraft is near an obstacle that is at a similar altitude with the bottom of the aircraft. The aircraft cannot detect the obstacle as most or even the whole obstacle is out of the detection range.

### Horizontal Obstacle Avoidance Usage

Make sure horizontal and backward obstacle avoidance are enabled in the app. Obstacle avoidance is used in the following two scenarios:

1. The aircraft begins to decelerate when it detects an obstacle 15 m in front of the aircraft (when the aircraft is flying forward) or 15 m behind the aircraft (when the aircraft is flying backward), then brakes and hovers. While braking, the aircraft cannot accelerate toward the obstacle but can fly away from it.

2. The aircraft immediately brakes and hovers if it detects an obstacle nearby. Users cannot control the aircraft while it is braking.

Users can fly in a direction away from the obstacle to regain full control of the aircraft.



- Backward obstacle avoidance will be disabled when the aircraft flies backward at a speed of more than 7 m/s. Fly with caution.
- Obstacle avoidance is disabled during auto landing. Make sure to operate the aircraft with caution when controlling the aircraft manually during auto landing.



If backward obstacle avoidance is disabled in the app, the aircraft cannot detect obstacles behind the aircraft while flying backward.

---

### Upward Radar Usage

Make sure the upward obstacle avoidance function of the radar module is enabled in the app. Obstacle avoidance is used in the following two scenarios:

1. The aircraft begins to decelerate when it detects an obstacle is 3 m away and brakes and hovers in place.
2. The aircraft immediately brakes if it detects an obstacle nearby.

Users cannot accelerate in the direction of the obstacle, but can fly in a direction away from the obstacle when the aircraft is braking or hovering.

### Terrain Follow and Bypassing Functions Usage

In Sensor Settings in the app, select the task terrain according to the environment and enable Auto Terrain Follow and Obstacle Bypassing. Each type of task terrain is suitable for the corresponding operation modes. Refer to the descriptions below.



- Bypassing is disabled during night or in dark environments. Fly with caution.
- In some scenarios such as with power lines, the bypassing function may not be able to bypass the obstacle successfully. Users can bypass the obstacle by manually controlling the aircraft.
- Terrain follow will be affected when the aircraft is flying over water. Fly with caution.



The max flight speed of the aircraft will be limited to 7 m/s and the height above the vegetation will be limited from 2.5 to 8 m when obstacle bypassing is enabled.

---

### Mapping/Field on Flatland

This task terrain is suitable for Mapping operations or Route, A-B Route, and Manual operations in areas without obvious surface elevation changes.

1. Select Mapping/Field on Flatland as the task terrain.
2. Enable Auto Terrain Follow only. Enter the desired operation mode and set the height above the vegetation. After the operation is started, the aircraft will fly above the vegetation at the pre-set height.
3. Enable both Auto Terrain Follow and Obstacle Bypassing (supporting Route and A-B Route operations only). After a Route or A-B Route operation is started, the aircraft will bypass detected obstacles automatically. Moving the control stick can pause auto bypassing. The aircraft will hover in place if bypassing fails. Users can bypass the obstacle by manually controlling the aircraft.

## Fruit Orchard on Flatland and Mountain Land

Both Fruit Orchard on Flatland and Mountain Land are suitable for Route and A-B Route operations. Fruit Orchard on Flatland is suitable for terrain without obvious surface elevation changes. Mountain Land is suitable for undulating terrain covered with mountain crops and fruit trees. Flying vertically to bypass obstacles takes priority in Mountain Land mode. Both modes have the same operation instructions.

1. Select the corresponding task terrain.
2. Enable Terrain Follow and Obstacle Bypassing. After a Route or A-B Route operation is started, the aircraft will fly above the vegetation at the pre-set height and bypass detected obstacles automatically. Moving the control stick can pause auto bypassing. The aircraft will hover in place if bypassing fails. Users can bypass the obstacle by manually controlling the aircraft.

## RadAR Usage Notice



- DO NOT touch or let your hands or body come in contact with the metal parts of the radar module when powering on or immediately after flight as they may be hot.
- Maintain full control of the aircraft at all times and do not rely completely on the radar module and DJI Agras app. Keep the aircraft within VLOS at all times. Use your discretion to operate the aircraft manually to avoid obstacles.
- In Manual operation mode, users have complete control of the aircraft. Pay attention to the flying speed and direction when operating. Be aware of the surrounding environment and avoid the blind spots of the radar module.
- The obstacle avoidance functions are disabled in Attitude mode.
- When sensing objects such as an inclined line, inclined utility pole, or power line at an inclined angle against the flying direction of the aircraft, the radar detection performance will be affected since most of the radar electromagnetic waves are reflected to other directions. Fly with caution.
- The radar module enables the aircraft to maintain a fixed distance from vegetation only within its working range. Observe the aircraft's distance from vegetation at all times.
- Operate with extra caution when flying over inclined surfaces. The recommended maximum inclination at different aircraft speeds are 10° at 1 m/s, 6° at 3 m/s, and 3° at 5 m/s.
- Comply with local radio transmission laws and regulations.
- The sensitivity of the radar module may be reduced when operating several aircraft within a short distance. Operate with caution.
- The radar module is a precision instrument. DO NOT squeeze, tap, or hit the radar module.
- Before use, make sure that the radar module is clean and the outer protective cover is not cracked, chipped, sunken, or misshapen.



Keep the protective cover of the radar module clean. Clean the surface with a soft damp cloth and air dry before using again.

## Binocular Vision System Usage Notice

---



- The performance of the binocular vision system is affected by light intensity and the patterns or texture of the surface being flown over. Operate the aircraft with great caution in the following situations:
  - a. Flying over monochrome surfaces (e.g., pure black, pure white, pure green).
  - b. Flying over highly reflective surfaces.
  - c. Flying over water or transparent surfaces.
  - d. Flying in an area where the lighting changes frequently or drastically.
  - e. Flying over extremely dark (< 10 lux) or bright (> 10,000 lux) surfaces.
  - f. Flying over surfaces with repeating identical patterns or textures or with particularly sparse patterns or textures.
- Keep the cameras of the binocular vision system clean at all times.
- Make sure that there are clear patterns and adequate lighting in the surroundings since the binocular vision system relies on images of the surrounding environment to obtain displacement data.
- The obstacle sensing function of the binocular vision system may not work properly when the aircraft is operated in a dim environment or over water or surfaces without a clear pattern.



- Keep the cameras of the binocular vision system clean. Make sure that the aircraft is powered off. First remove any larger pieces of grit or sand then wipe the lens with a clean, soft cloth to remove dust or other dirt.
- 

## Control Station

### Profile

The DJI RC Plus remote controller is used as a control station. The remote controller features DJI O3 Agras, the latest version of the signature OcuSync image transmission technology, with a maximum transmission distance of 7 km (at an altitude of 2.5 m).<sup>[1]</sup> The remote controller has a built-in 7.02-in high brightness touchscreen powered by the Android operating system. Users can connect to the internet via Wi-Fi or the DJI Cellular Dongle. Operations are more convenient and accurate than ever before thanks to the revamped DJI Agras app design and a wide range of buttons on the remote controller. The remote controller has a maximum operating time of 3 hours 18 minutes with the internal battery and 6 hours when mounted with an external WB37 Intelligent Battery, to cater for long and high-intensity operations.

[1] The remote controller is able to reach its maximum transmission distance (FCC/NCC: 7 km (4.35 mi); SRRC: 5 km (3.11 mi); CE/MIC: 4 km (2.49 mi)) in an open area with no electromagnetic interference and at an altitude of approximately 2.5 m (8.2 ft).

## Remote Controller Overview

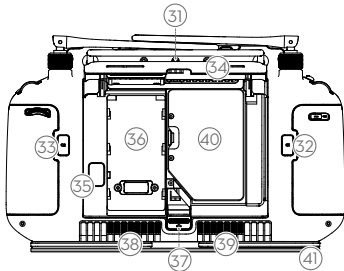
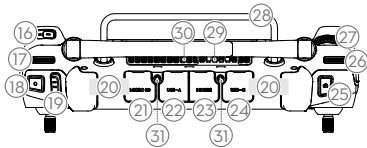
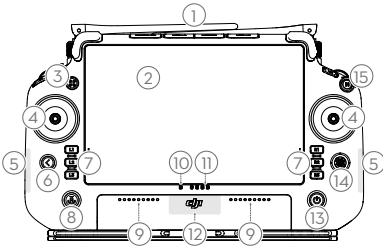

1. **External RC Antennas**  
Relays the aircraft control and image transmission signal.
2. **Touchscreen**  
Displays system and app views and supports up to 10 touch points. Android-based device for running the DJI Agras app.
3. **Indicator Button (reserved)**
4. **Control Sticks**  
Controls aircraft movement. Control mode can be set in DJI Agras.
5. **Internal Wi-Fi Antennas**  
Do not block the internal Wi-Fi antennas during use, otherwise the signals may be affected.
6. **Back Button**  
Press once to return to the previous screen. Press twice to return to the home screen. Hold the back button and press another button to activate button combinations. Refer to the Button Combinations section for more information.
7. **L1/L2/L3/R1/R2/R3 Buttons**  
When buttons are displayed in the app near these physical buttons or the prompts in the app include L1/L2/L3/R1/R2/R3, press the corresponding button on the remote controller to operate instead of tapping the touchscreen.
8. **Return to Home (RTH) Button**  
Press and hold to initiate RTH. Press again to cancel RTH.
9. **Microphones**
10. **Status LEDs**  
Indicates the status of the remote controller. Refer to Guide on the home screen for more information.
11. **Battery Level LEDs**  
Displays the current battery level of the internal battery.
12. **Internal GNSS Antennas**  
Do not block the internal GNSS antennas during use. Otherwise the positioning accuracy may be affected.
13. **Power Button**  
Press once to check the current battery level. Press, and then press and hold to power the remote controller on or off. When the remote controller is powered on, press once to turn the touchscreen on or off.
14. **5D Button**
15. **Flight Pause Button (reserved)**
16. **Button C3**  
Press to enable or disable horizontal obstacle avoidance after DJI Agras is launched.
17. **Left Dial**  
Turn to adjust the spray rate in Manual operation mode.

- 18. Spray/Spread Button**  
Press to start or stop spraying/spreading in Manual operation mode.
- 19. Flight Mode Switch**  
The three positions of the switch correspond to: N-mode (Normal), S-mode (Attitude), and F-mode (Normal).
- 20. Internal RC Antennas**  
Relays aircraft control and image transmission signals. Do not block the internal RC antennas during use. Otherwise the signals may be affected.
- 21. microSD Card Slot**  
Slot to insert a microSD card.
- 22. USB-A Port**  
For connecting devices such as the RTK Dongle. When it is connected to the intelligent charger or multifunctional inverter generator, users can view the device status information in DJI Agras.
- 23. HDMI Port**  
The output of the HDMI signal to an external monitor.
- 24. USB-C Port**  
For charging the remote controller or connect to a computer to update firmware and export logs via the DJI Assistant 2 software.
- 25. FPV/Map Switch Button**  
In Operation View in DJI Agras, press to switch between FPV and Map View.
- 26. Right Dial**  
Turn to adjust the tilt of the FPV camera.
- 27. Scroll Wheel (reserved)**
- 28. Handle**
- 29. Speaker**
- 30. Air Vent**  
For heat dissipation. Do not block the air vent during use.
- 31. Reserved Mounting Holes**
- 32. Button C1**  
In A-B Route operation mode, press to add Point A.
- 33. Button C2**  
In A-B Route operation mode, press to add Point B.
- 34. Rear Cover**
- 35. Battery Release Button**
- 36. Battery Compartment**  
For installing the WB37 Intelligent Battery.
- 37. Rear Cover Release Button**
- 38. Alarm**
- 39. Air Intake**  
For heat dissipation. Do not block the air intake during use.
- 40. Dongle Compartment**  
The USB-C connector in the compartment is used to connect the DJI Cellular Dongle.
- 41. Strap Bracket**



## Using the Remote Controller

### Powering the Remote Controller On and Off

Both the internal battery and external battery can be used to supply power to the remote controller. The battery level is indicated via the battery level LEDs on the remote controller or on the external battery. Follow the steps below to power on the remote controller:

1. When the remote controller is powered off, press the power button once to check the current battery level of the internal battery. Press the battery level button on the external battery to check the current battery level of the external battery. If the battery level is too low, recharge before use.
2. Press the power button once, then press and hold to power on the remote controller.
3. The remote controller beeps when powered on. The status LED glows solid green when linking is complete.
4. Repeat Step 2 to power off the remote controller.

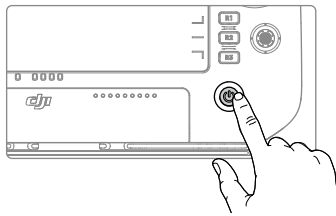

### Charging the Batteries

1. Use the DJI 65W Portable Charger to charge both the internal and external batteries simultaneously.

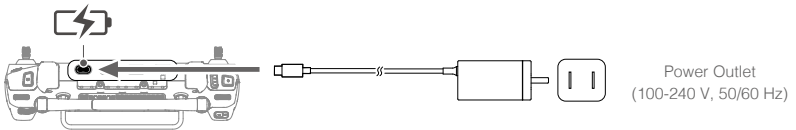

- 
- ⚠ • Use the provided charger to charge the remote controller. Otherwise, use a locally certified USB-C charger with a maximum rated power and voltage of 65 W and 20 V.
  - Fully charge and discharge the internal and external batteries of the remote controller at least once every three months. The battery will deplete when it is stored for an extended period.
- 

2. Use the WB37 Battery Charging Hub (USB-C) and 65W Portable Charger to charge the external battery. Refer to the WB37 Battery Charging Hub (USB-C) User Guide for more information.

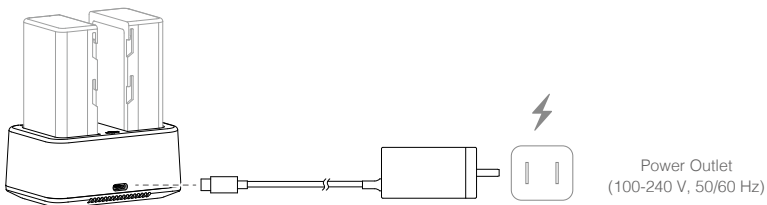

## Operating the Aircraft

This section explains how to control the orientation of the aircraft through the remote controller. Control can be set to Mode 1, Mode 2, or Mode 3.

### Mode 1

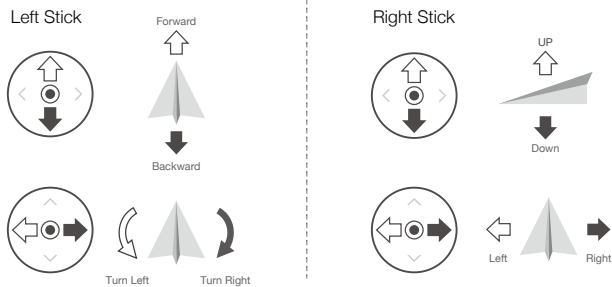



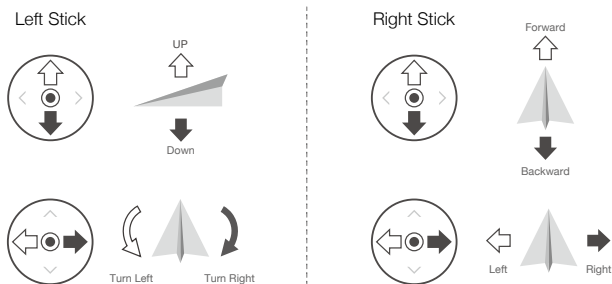

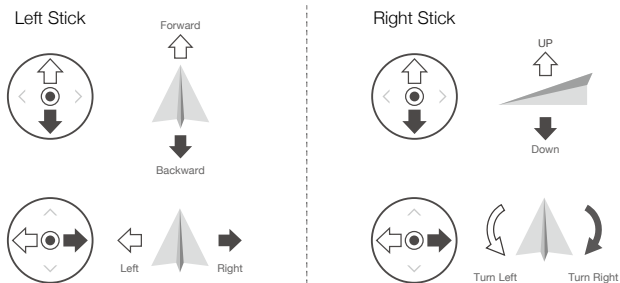

### Mode 2

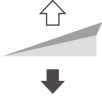

### Mode 3



For example, the following description uses Mode 2:

Remote Controller (Mode 2)	Aircraft (● Indicates nose direction)	Remarks
<p>Left Stick</p> 		<p><b>Throttle Stick:</b> Move the left stick vertically to control the elevation of the aircraft.</p> <p>Push up to ascend and push down to descend. Use the left stick to take off when the motors are spinning at an idle speed. The aircraft hovers in place if the stick is in the center position. The further the stick is pushed away from the center position, the faster the aircraft changes elevation.</p>
<p>Left Stick</p> 		<p><b>Yaw Stick:</b> Move the left stick horizontally to control the heading of the aircraft.</p> <p>Push left to rotate the aircraft counterclockwise and push right to rotate clockwise. The aircraft hovers in place if the stick is in the center position. The further the stick is pushed away from the center position, the faster the aircraft rotates.</p>
<p>Right Stick</p> 		<p><b>Pitch Stick:</b> Move the right stick vertically to control the pitch of the aircraft.</p> <p>Push up to fly forwards and press down to fly backwards. The aircraft hovers in place if the stick is in the center position. Push the stick further for a larger pitch angle and faster flight.</p>
<p>Right Stick</p> 		<p><b>Roll Stick:</b> Move the right control stick horizontally to control the roll of the aircraft.</p> <p>Push the stick left to fly left and right to fly right. The aircraft hovers in place if the stick is in the central position. Push the stick further for a larger roll angle and faster flight.</p>

## Controlling the Spraying System

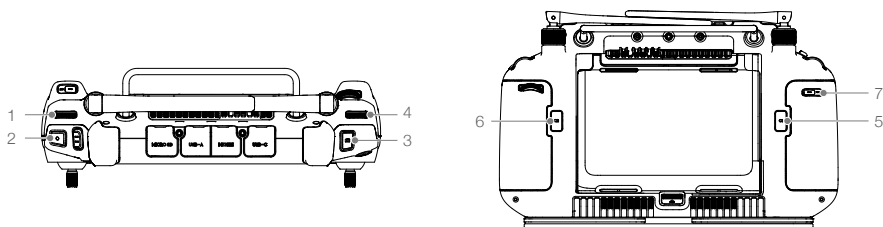

### 1. Left Dial

In Manual operation mode, turn left to reduce and right to increase the spray rate.\* The app indicates the current spray rate.

\* Spray rate may vary according to the sprinkler model and viscosity of the liquid.

### 2. Spray/Spread Button

In Manual operation mode, press to start or stop spraying.

### 3. FPV/Map Switch Button

In Operation View in DJI Agras, press to switch between FPV and Map View.

### 4. Right Dial

When the aircraft is not performing a Mapping operation, turn the dial to adjust the tilt of the FPV camera. The tilt cannot be adjusted during Mapping operations.

### 5. Button C1

Records Point A of the route in an A-B Route operation.

### 6. Button C2

Records Point B of the route in an A-B Route operation.

### 7. Button C3



Press to enable or disable horizontal obstacle avoidance after DJI Agras is launched.

## Flight Mode Switch

Toggle the switch to switch between flight modes.

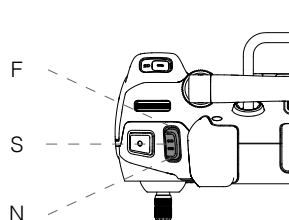
Position	Flight Mode
N	N-mode (Normal)
S	S-mode (mapped to A-mode, Attitude)
F	F-mode (Normal)



Regardless of the position the switch is in on the remote controller, the aircraft begins in N-mode by default. To switch flight modes, first go to Operation View in DJI Agras, tap , then , and enable “Enable Attitude Mode” in Advanced Settings. After enabling Attitude mode, toggle the switch to N or F and then to S to switch the flight mode to Attitude mode.

The aircraft still begins in N-mode by default after powering on, even though A-mode was enabled in the app beforehand. When A-mode is required, toggle the Flight Mode switch as mentioned above after powering on the remote controller and aircraft.

### RTH Button

Press and hold the RTH button to bring the aircraft back to the last recorded home point. The LED around the RTH Button blinks white during RTH. Users can control aircraft altitude while it flies to the home point. Press this button again to cancel RTH and regain control of the aircraft.

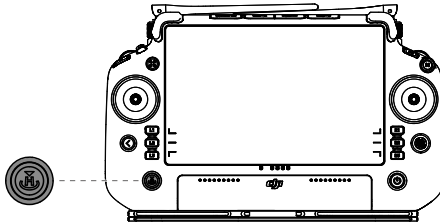

### Optimal Transmission Zone

Lift and adjust the antennas. The strength of the remote controller signal is affected by the position of the antennas. Adjust the direction of the external RC antennas of the remote controller so that the controller and aircraft are within the optimal transmission zone.

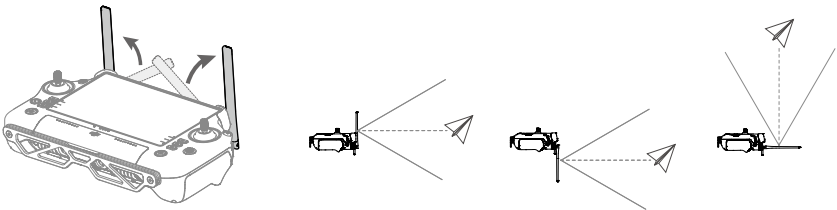

### Button Combinations

Some frequently-used features can be activated by using button combinations. Use the back button and the other button at the same time to execute a specific function.

Button Combinations	Description
Back Button + Left Dial	Adjust the screen brightness
Back Button + Right Dial	Adjust the system volume
Back Button + Spray Button	Record the screen
Back Button + FPV/Map Switch Button	Screenshot the screen
Back Button + 5D Button	Toggle up - Home; toggle down - Quick Settings; toggle left - Recently opened apps

## Remote Controller LEDs

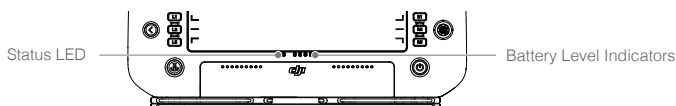

The battery level indicators display the battery level of the controller. The status LED displays the linking status and warnings for control stick, low battery level, and high temperature.

Blinking Patterns	Descriptions
Solid red	Disconnected with aircraft
Blinking red	Low aircraft battery level
Solid green	Connected with aircraft
Blinking blue	The remote controller is linking to an aircraft
Solid yellow	Firmware update failed
Blinking yellow	Low remote controller battery level
Blinking cyan	Control sticks not centered

Battery Level Indicators				Battery Level
				75%~100%
				50%~75%
				25%~50%
				0%~25%

## Remote Controller Alert

The remote controller vibrates or beeps to issue an error alert or warning. For detailed information, see the real-time prompts on the touchscreen or in the DJI Agras app. To disable some alerts, slide down from the top and select Do Not Disturb in Quick Settings.

Any voice prompts and alerts will be disabled in Silent mode, including alerts during RTH and low battery alerts for the remote controller or aircraft. Fly with caution.

## Linking the Remote Controller

The remote controller is linked to the aircraft by default. Linking is only required when using a new remote controller for the first time. When using the Multi-Aircraft Control function, it is required to link all aircraft to the same remote controller.

1. Power on the remote controller and open DJI Agras. Power on the aircraft.
2. Tap Execute Operation to enter Operation View and tap then . Tap Single Linking and then Starting Linking. The status LED blinks blue and the remote controller beeps twice repeatedly, indicating that the remote controller is ready for linking.

3. Press and hold the power button on the Intelligent Flight Battery for five seconds. The Intelligent Flight Battery LEDs blink in sequence, indicating that the linking is in progress.
4. The Status LED on the remote controller glows solid green if linking is successful. If linking fails, enter linking status again and retry.

## Operating the Touchscreen

### Home Screen

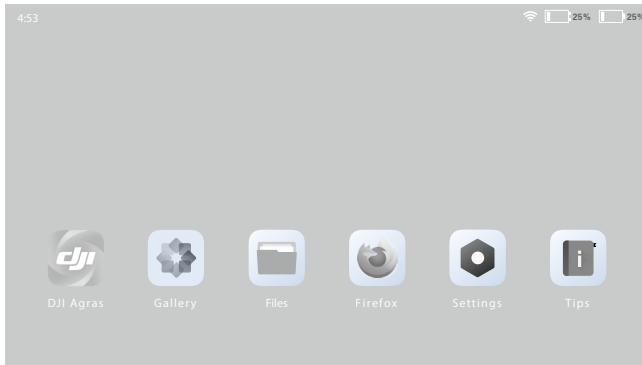

The top bar displays the time, network status, as well as battery levels of the internal and external batteries of the remote controller.

### Operations

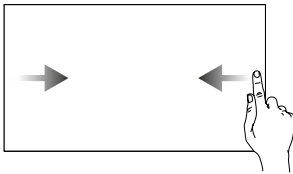

Slide from the left or right to the center of the screen to return to the previous screen.

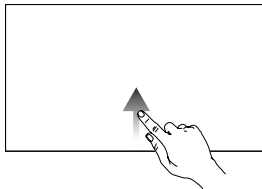

Slide up from the bottom of the screen to return to the home screen.

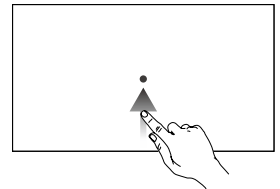

Slide up from the bottom of the screen and hold to access recently opened apps.

### Quick Settings

Slide down from the top to enter Quick Settings.

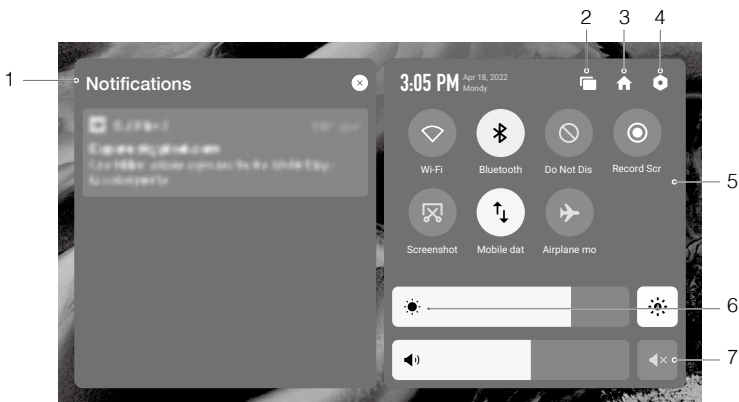

#### 1. Notifications

Tap to view system or app notifications.

#### 2. Recent

Tap to view and switch to recently opened apps.

#### 3. Home

Tap to return to the home screen.

#### 4. System Settings

Tap to access system settings.

#### 5. Shortcuts

: Tap to enable or disable Wi-Fi. Hold to enter settings and connect to or add a Wi-Fi network.

: Tap to enable or disable Bluetooth. Tap and hold to open settings and connect with nearby Bluetooth devices.

: Tap to enable DO NOT Disturb mode. In this mode, system prompts will be disabled.

: Tap to start screen recording.

: Tap to screenshot the screen.

: Mobile data. Tap to turn mobile data on or off; long press to set mobile data and diagnose network connection status.

: Tap to enable Airplane mode. Wi-Fi, Bluetooth, and mobile data will be disabled.

#### 6. Adjust Brightness

Slide the bar to adjust the brightness. Tap the icon to auto-brightness mode. Tap the icon or slide the bar to switch to manual brightness mode.

#### 7. Adjust Volume

Slide the bar to adjust the volume and tap to mute. Note that after muting, all sounds of the remote controller will be completely disabled, including related alarm sounds. Please turn on the mute with caution.



## Advanced Features

### Calibrating the Compass

After the remote controller is used in places with electro-magnetic interference, the compass may need to be calibrated. A warning prompt will appear if the remote controller's compass requires calibration. Tap the warning prompt to start calibrating. In other cases, follow the steps below to calibrate your remote controller.

1. Power on the remote controller and go to the home screen.
2. Tap Settings, scroll down and tap Compass.
3. Follow the diagram on the screen to calibrate your remote controller.
4. The user will receive a prompt when the calibration is successful.

### HDMI Settings

The touchscreen can be shared to a display after connecting the HDMI port of the remote controller. The resolution can be set by entering Settings, Display, and then Advanced HDMI.

### DJI Agras App (Information Display and User Interface)

DJI Agras is designed for agricultural applications. The app has a clear and concise interface and displays the status of the aircraft, spraying system, and other devices connected to the remote controller, and enables users to configure various settings. After planning a field via the intelligent operation planning system of the app, the aircraft can automatically follow the pre-planned flight route.



### Home Screen

#### 1. Document Management

 : view planned fields, operation progress, and resources such as prescription maps and reconstruction output. You can synchronize the local data with the data on the DJI AG platform.

#### 2. User Info

 : view account information.

#### 3. Aircraft Info

 : view the information of the connected aircraft such as the firmware version.

4. Troubleshooting

: view solutions for errors of each module and upload error logs.

5. Notification Center

: check notifications about any changes to the aircraft, users, or operations.

6. General Settings

: tap for settings such as units of measurement, network diagnosis, and Android system settings.

7. Firmware Notifications

: shows the firmware update notifications. Tap to enter the firmware page.

8. Aircraft Connection Status

: shows if the aircraft is connected to the remote controller.

9. Begin

Tap to enter Operation View.

Operation View

View the aircraft status, set parameters, switch between operation modes, plan a field, and perform operations in Operation View.

Slide from the left or right to the center of the screen to return to the home screen. Tap and hold the icons or buttons in Operation View to check function descriptions. The following section describes the other displayed information and the setting menu in Operation View.

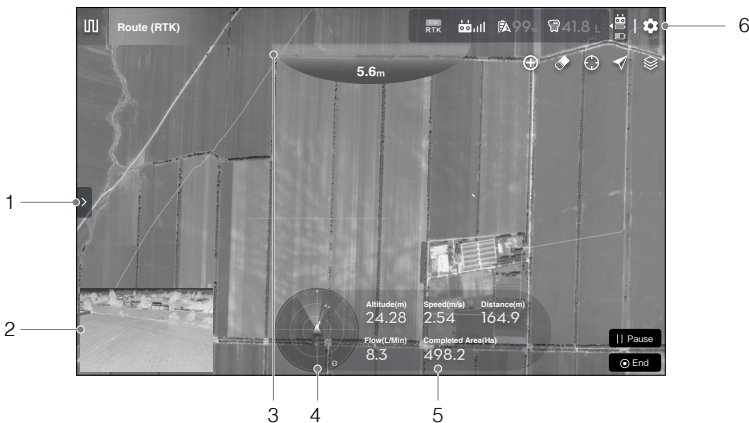

1. Field List/Task Settings

Tap > to expand the list.

When the aircraft is not performing any operations, the field list will be displayed, users can view the planned fields and the operations being executed.

When an operation has been applied or started, the task settings will be displayed where users can set operation parameters. The adjustable parameters vary between different operation modes.

2. **FPV Camera View**

Displays the live view from the FPV camera. Tap to switch between the Map View and Camera View.

3. **Upward Obstacle Indicator**

If upward obstacle avoidance is enabled, a red zone will appear on the top of the screen when an obstacle is detected including the distance from the obstacle.

4. **Radar Indicator**

Displays information such as the orientation of the aircraft and the Home Point. Shows information on the detected obstacles when the horizontal obstacle avoidance function is enabled. Red, yellow, and green zones indicate the relative distance of the obstacles ranging from near to far. The value indicates the distance in meters or feet depending on the settings. Tap the radar indicator to enable or disable horizontal obstacle avoidance and set the side obstacle detection distance in the pop-up menu. There will be a red circle around the radar indicator when horizontal obstacle avoidance is disabled.

5. **Flight Telemetry and Operation Status**

**Altitude:** when the terrain follow function is enabled, it shows the height between the aircraft and the nearest object or ground underneath the aircraft. If the terrain follow function is disabled, it displays the altitude between the aircraft and the takeoff point.

**Distance:** displays the horizontal distance from the aircraft to the Home Point.

**Speed:** displays the flight speed of the aircraft.

**Flow:** displays the liquid flow rate.

**Area:** displays the area values related to the task area.

6. **Settings**

Tap  to enter the extended menu to view and adjust the parameters of all other settings.

 **Aircraft Settings:** include setting the connection routing and RTH speed and altitude, maximum altitude, maximum flight distance, whether to display the empty tank point, the action to perform when the tank is empty and when an operation is completed, the action to perform and whether to abort operation when the remote controller signals are lost, home point position, spotlight switch, and advanced settings.

 **Spraying System Settings:** include setting the spraying system switch, spraying system real-time data switch, empty tank warning, spray droplet size, flow meter calibration, restoring the flow meter to factory settings, and setting the weight sensors.

 **RC Settings:** includes linking and calibrating remote controllers, setting the control stick mode and customizable buttons, and checking information of linked aircraft.

● **Sensor Settings:** include setting, horizontal obstacle avoidance, backward obstacle avoidance, obstacle avoidance audio alert, upward obstacle avoidance, radar sensitivity, side obstacle detection distance, warning distance, obstacle distance display, task terrain, terrain follow and bypassing, and advanced settings.

**RTK RTK Settings:** includes RTK signal source and the corresponding settings.

**HD Image Transfer Settings:** includes channel mode and sweep frequency chart selection.

 **Aircraft Battery:** includes low battery warning threshold, low battery action, and battery information.

••• **General Settings:** includes map settings, flight route display, and FPV settings.

## Command and Control Link

The command and control (C2) link between the aircraft and remote controller is established using DJI O3 Agrab transmission technology with the two OcuSync antennas on the aircraft and DJI O3 Agrab image transmission system, offering a maximum transmission range of 7 km. Its performance is listed below.

Operating Frequency*	2.4000-2.4835 GHz, 5.725-5.850 GHz
Transmitter Power (EIRP)	2.4 GHz: <33 dBm (FCC), <20 dBm (CE/SRRC/MIC) 5.8 GHz: <33 dBm (FCC), <14 dBm (CE), <23 dBm (SRRC)

\* 5.8 GHz frequency is prohibited in some countries.

## Ground Operational Area Setup

It is recommended to take off the aircraft in an open area. When taking off, the operator should be more than 10 m away from the aircraft.

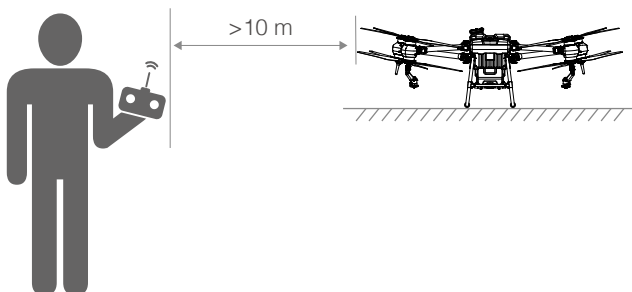

# Performance and Limitations

## Performance

### T40

Basic Empty Weight	50 kg
Max Takeoff Weight	Max takeoff weight for spraying: 90 kg (at sea level) Max takeoff weight for spreading: 101 kg (at sea level)
Top Speed/Never Exceed Speed	10 m/s (at sea level)
Endurance*	18 min (takeoff weight of 50 kg with a 30Ah battery) 7 min (takeoff weight of 90 kg with a 30Ah battery) 6 min (takeoff weight of 101 kg with a 30Ah battery)
Flight Battery	Type: Li-ion Capacity: 30 Ah Energy: 1567 Wh
Max Wind Resistance	6 m/s
Max Service Ceiling Above Sea Level	4500 m
Max Flight Range	2000 m

\* The endurance is tested in laboratory environment and is for reference only. The endurance under actual operating conditions will be reduced.

### T20P

Basic Empty Weight	32 kg
Max Takeoff Weight	Max takeoff weight for spraying: 52 kg (at sea level) Max takeoff weight for spreading: 58 kg (at sea level)
Top Speed/Never Exceed Speed	10 m/s (at sea level)
Endurance*	14.5 min (takeoff weight of 32 kg with a 13Ah battery) 7 min (takeoff weight of 52 kg with a 13Ah battery) 6 min (takeoff weight of 58 kg with a 13Ah battery)
Flight Battery	Type: Li-ion Capacity: 13 Ah Energy: 679 Wh
Max Wind Resistance	6 m/s
Max Service Ceiling Above Sea Level	4500 m
Max Flight Range	2000 m

\* The endurance is tested in laboratory environment and is for reference only. The endurance under actual operating conditions will be reduced.

## Prohibited Maneuvers

The following actions are prohibited.

1. Be under the influence of alcohol, drugs, or anesthesia, or suffering from dizziness, fatigue, nausea, or any other conditions, whether physical or mental, that could impair your ability to operate the aircraft safely.
2. Stop the motors mid-flight. NOTE: this is not prohibited in an emergency situation where doing so will reduce the risk of damage or injury.
3. Upon landing, power off the remote controller before powering off the aircraft.
4. Drop, launch, fire, or otherwise project any dangerous payloads on or at any buildings, persons, or animals, or which could cause personal injury or property damage.
5. Fly the aircraft recklessly without any plan.
6. Use this product for any illegal or inappropriate purpose such as spying, military operations, or unauthorized investigations.
7. Use this product to defame, abuse, harass, stalk, threaten, or otherwise violate the legal rights of others, such as the right of privacy and publicity.
8. Trespass onto private property of others.

## Center of Gravity Limitations

1. Using the M1 motor shaft as a reference, the center of gravity of the aircraft in the front-to-back direction ranges from 768.1 to 828.6 mm (for T40) and 755.8 to 806 mm (for T20P), as shown in the diagram below.
2. Using the lowest point of the aircraft as a reference, the center of gravity in the vertical direction of the aircraft ranges from 529.0 to 536.1 mm (for T40) and 401.5 to 416.4 mm (for T20P), as shown in the diagram below.
3. The center of gravity of the aircraft in the left-to-right direction should be the symmetrical center of the aircraft.

T40

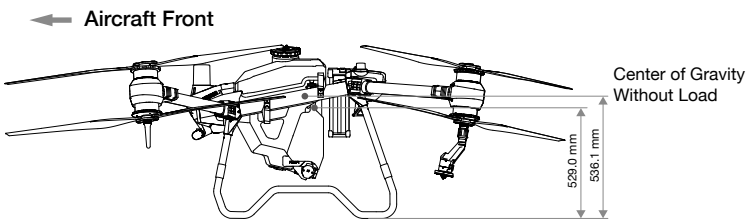
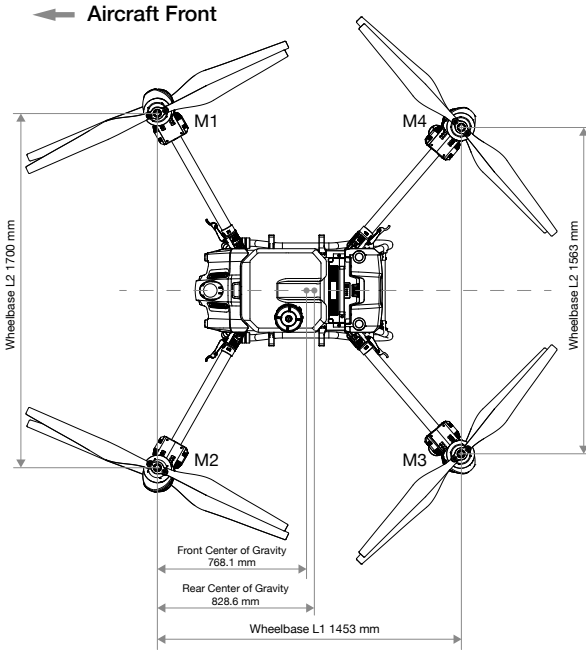

T20P

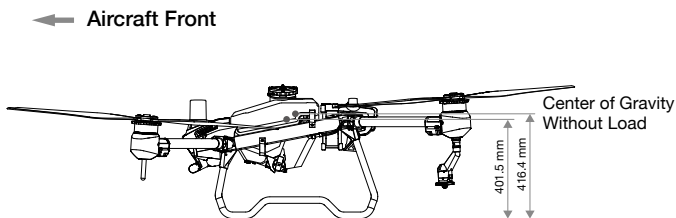
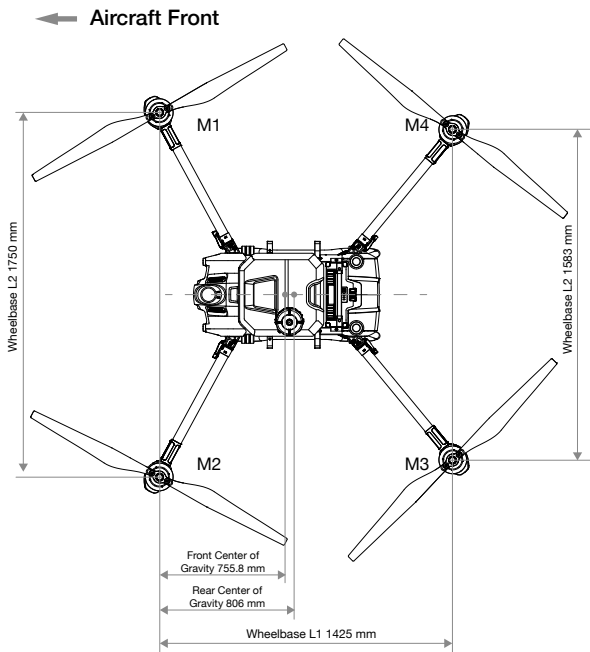



## Applicable Environmental Limitations

1. DO NOT use the aircraft in adverse weather conditions such as winds exceeding 6 m/s, rain, snow, or fog.
2. Aircraft and battery performance is subject to environmental factors such as air density and temperature. Be careful when flying 2 km (6,560 ft) or more above sea level as battery and aircraft performance may be reduced.
3. DO NOT use the aircraft near accidents, fire, explosions, floods, tsunamis, avalanches, landslides, earthquakes, dust, or sandstorms.
4. In low temperature environments (between 0° and 10° C (32° and 50° F)), make sure that the flight battery is fully charged and be sure to reduce the payload of the aircraft. Otherwise, it will affect the flight safety or a takeoff limit will occur.

# Normal Procedures

## Airspace Environment

The DJI Agras T40/T20P is a multi-copter crop protection RPAS mainly operated in farming, forestry, animal husbandry and fishery scenarios. Once pre-flight preparation is complete, it is recommended to hone your flight skills and practice flying safely. Make sure that all flights are carried out in an open area.

## Operation Environment

1. To avoid injury and damage and make sure spraying is effective, spray in winds lower than 6 m/s. It is recommended to spray in winds lower than 3 m/s for herbicides, fungicides, and insecticides that may drift and cause phytotoxicity and can be poisoning.
2. DO NOT use the aircraft in adverse weather conditions such as winds exceeding 6 m/s, rain, snow, or fog.
3. Only fly in open areas. Tall buildings and steel structures may affect the accuracy of the compass and the GNSS signal.
4. Pay attention to utility poles, power lines, and other obstacles. DO NOT fly near or above water, people, or animals.
5. Maintain VLOS of the aircraft at all times, and avoid flying near obstacles, crowds, animals, and bodies of water.
6. Avoid flying in areas with high levels of electromagnetism, including mobile phone base stations and radio transmission towers.
7. DO NOT fly more than 4500 m above sea level.
8. The DJI Agras app will intelligently recommend the payload weight limit for the tank according to the current status and surroundings of the aircraft. Do not exceed the recommended payload weight limit when adding material to the tank. Otherwise, the flight safety may be affected.
9. Make sure that there is a strong GNSS signal and the D-RTK antennas are unobstructed during operation.
10. DO NOT operate the aircraft indoors.

## GEO (Geospatial Environment Online) System

### GEO Zones

DJI's GEO System designates safe flight locations, provides risk levels and safety concerns for individual flights, and offers restricted airspace information. The locations designated by GEO are called GEO Zones. GEO Zones are specific flight areas that are categorized by flight regulations and restrictions. GEO Zones that prohibit flight are implemented around locations such as airports, power plants, and prisons. They can also be temporarily implemented around major stadium events, forest fires, or other emergency situations. Certain GEO Zones do not prohibit flight but do trigger warnings informing users of potential risks. All restricted flight areas are referred to as GEO Zones, and are further divided into Warning Zones, Enhanced Warning Zones, Authorization Zones, Altitude Zones, and Restricted Zones. By default, GEO limits flights into or taking off within zones that may result in safety or security concerns. There is a GEO Zone Map, which contains comprehensive global GEO Zone information on the official DJI website: <https://www.dji.com/flysafe>.

The GEO System is for advisory purposes only. Individual users are responsible for checking official sources and determining which laws or regulations may apply to their flight. In some instances, DJI has selected widely-recommended general parameters (such as a 1.5-mile radius at airports) without making any determination as to whether these guidelines match regulations that apply to specific users.

## GEO Zone Definitions

**Warning Zones:** Users receive a warning message with information relevant to their flight.

**Enhanced Warning Zones:** Users receive a prompt from the GEO System at the time of flight. They are required to confirm their flight path.

**Authorization Zones:** Users receive a warning message and the flight is prohibited by default. Authorization Zones can be unlocked by authorized users with a DJI-verified account. Self-Unlocking privileges must be applied for online. <https://www.dji.com/flysafe>

**Altitude Zones:** Flights are limited to a specific altitude.

**Restricted Zones:** Flights are completely prohibited. UAVs cannot fly in these zones. If you have obtained permission to fly in a Restricted Zone, please go to <https://www.dji.com/flysafe> or contact [flysafe@dji.com](mailto:flysafe@dji.com) to unlock the zone.

DJI GEO Zones aim to ensure the user's flight safety, but it cannot be guaranteed to be in full compliance with local laws and regulations. Users should check local laws, regulations, and regulatory requirements before each flight and are responsible for the flight safety.

All intelligent flight features will be affected when DJI aircraft fly nearby or into GEO Zones. Such interference includes, but is not limited to, decreased speed, takeoff failure, and flight termination.

## Flight Limits

Unmanned aerial vehicle (UAV) operators should abide by the regulations from self-regulatory organizations such as the International Civil Aviation Organization, the Federal Aviation Administration, and their local aviation authorities. For safety reasons, flight limits are enabled by default to help users operate this aircraft safely and legally. Users can set flight limits on height and distance.

When operating with a strong GNSS signal, the height and distance limits and GEO zones work together to monitor flight. With a weak GNSS signal, only the firmware height limit prevents the aircraft from going above 100 meters.

### Maximum Height and Radius Limits

Users can change the maximum height and radius limits in the app. Once completed, the aircraft flight is restricted to a cylindrical area that is determined by these settings. The tables below show the details of these limits.

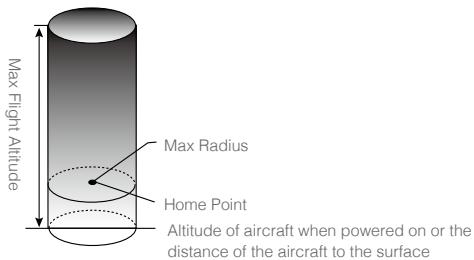

With a strong GNSS signal	
Flight Limits	
Max Height	Flight altitude must be below the preset height.
Max Radius	Flight distance must be within the max radius.

With a weak GNSS signal	
Flight Limits	
Max Height	Flight altitude must be below the preset height.
Max Radius	No limit.

-  • If the aircraft flies into a Restricted Zone, it can still be controlled, but the aircraft can only fly in a backward direction.
- If the aircraft loses GNSS signal and flies out of the max radius but regains GNSS signal later, it will fly back within range automatically.
- DO NOT fly near airports, highways, railway stations, railway lines, city centers, or other busy areas. Make sure the aircraft is visible at all times.

### GEO Zone Flight Restrictions

GEO Zone	Description
Restricted Zone	Takeoff: The aircraft's motors cannot be started.
	In-flight: When GNSS signal changes from weak to strong, the app starts a 100-second countdown. Once the countdown is over, the aircraft immediately lands in semi-automatic descent mode and turns off its motors after landing.
	In-flight: When the aircraft approaches the boundary of the Restricted Zone, it automatically decelerates and hovers.
Authorization Zone	Takeoff: The aircraft's motors cannot be started.
	In-flight: When GNSS signal changes from weak to strong, the app starts a 100-second countdown. Once the countdown is over, the aircraft immediately lands in semi-automatic descent mode and turns off its motors after landing.
Enhanced Warning Zone	The aircraft flies normally but the user is required to confirm the flight path.
Warning Zone	The aircraft flies normally but the user receives warning messages.
Altitude Zone	When GNSS signal is strong, the aircraft cannot exceed the specified altitude.
	In-flight: When GNSS signal changes from weak to strong, the aircraft will descend and hover below the altitude limit.

Altitude Zone	When the GNSS signal is strong, the aircraft approaches the boundary of the Altitude Zone. If it is higher than the altitude limit, the aircraft decelerates and hovers in place.
	When the GNSS signal changes from weak to strong, the app starts a 100-second countdown. Once the countdown is over, the aircraft will descend and hover below the altitude limit.
Free Zone	The aircraft flies normally with no restrictions.

 Semi-Automatic Descent: All stick commands except the throttle stick command and the RTH button are available during descent and landing. The aircraft motors will turn off automatically after landing. It is recommended to fly the aircraft to a safe location before the semi-automatic descent.

## Radio Frequency Environment

1. Avoid using wireless devices that use the same frequency bands as the remote controller.
2. When using with multiple aircraft, including T40, T20P, and other aircraft, make sure that the distance between each aircraft is more than 10 m to avoid interference.
3. The sensitivity of the radar module may be reduced when operating several aircraft within a short distance. Operate with caution.
4. Be alert when flying near areas with magnetic or radio interference. These include, but are not limited to, high voltage lines, large scale power transmission stations or mobile base stations, and broadcasting towers. Failing to do so may compromise the transmission quality of this product or cause transmission errors which may affect flight orientation and location accuracy. The aircraft may behave abnormally or go out of control in areas with too much interference.
5. If the RTK dongle is used for field planning, the module should be disconnected from the remote controller after planning is completed. Otherwise, it will affect the communication performance of the remote controller.

## Use of Launch and Recovery Equipment

Not applicable.

## Distance to Control Station

When taking off or landing, the aircraft should be more than 10 m away from the remote controller and operator to ensure safety. Maintain visual line of sight with the aircraft at all times.

## System Assembly

### Preparing the Aircraft

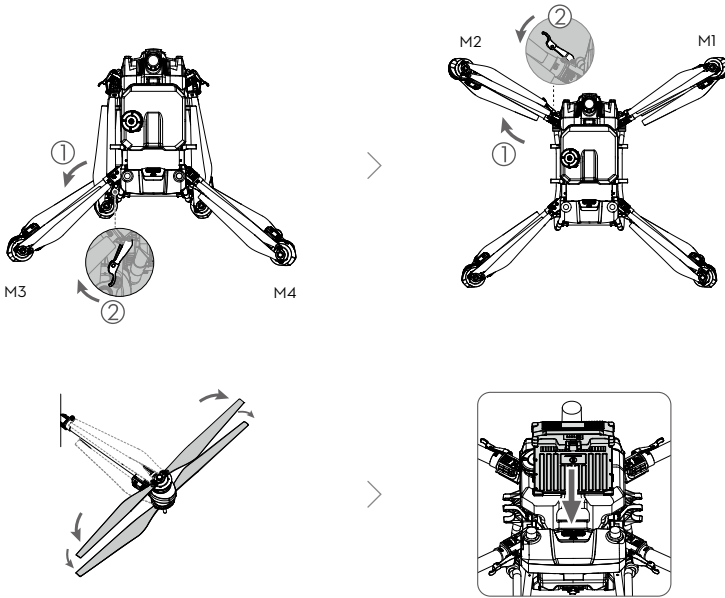

1. Unfold the M3 and M4 arms, and fasten the two arm locks. Avoid pinching fingers.
2. Unfold the M1 and M2 arms, and fasten the two arm locks. Avoid pinching fingers.
3. Unfold the propeller blades.
4. Insert the Intelligent Flight Battery into the aircraft until you hear a click.

The T40 uses the T40 Intelligent Flight Battery (model: BAX601-30000mAh-52.22V), while the T20P uses the T20P Intelligent Flight Battery (model: BAX601-13000mAh-52.22V). Check and charge the battery based on the requirements in the respective battery manual.

- ⚠ • Make sure that the battery is firmly inserted into the aircraft. Only insert or remove the battery when the aircraft is powered off.
- To remove the battery, press and hold the clamp and lift the battery up.
- When folding the arms, make sure to fold the M1 and M2 arms followed by the M3 and M4 arms and make sure that the arms are inserted into the storage clamps on both sides of the aircraft. Otherwise, the arms may be damaged.

### Preparing the Remote Controller

#### Mounting the WB37 Intelligent Battery

Follow the instructions below to mount the battery if using the WB37 Intelligent Battery for the remote controller power supply.

1. Push the rear cover release button to the end to open the rear cover.
2. Insert the WB37 battery into the battery compartment and push it to the top. There will be a clicking sound to indicate the battery is installed firmly.
3. Close the rear cover.

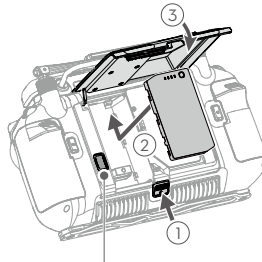

Battery Release Button

 To remove the WB37 battery, press and hold the battery release button and push the battery downward.

### Mounting the Dongle and SIM Card

-  Dongle related functions are not supported in some countries or regions. Comply with the local laws and regulations.
- Only use a DJI-approved dongle (name: DJI Cellular Dongle (LTE USB Modem), model: IG830/IG830E).
- The dongle and nano-SIM card enable the remote controller to access specific networks and platforms such as DJI Agras Intelligent Cloud. Make sure to insert them correctly. Otherwise, network access will not be available.

1. Press the rear cover release button to open the rear cover (1). Remove the screws (2) and open the dongle compartment cover (3).
2. Insert the nano-SIM card into the dongle (4). Insert the dongle into the USB-C connector in the dongle compartment (5). Close the dongle compartment cover (6).
3. Remount the screws (7). Close the rear cover (8).

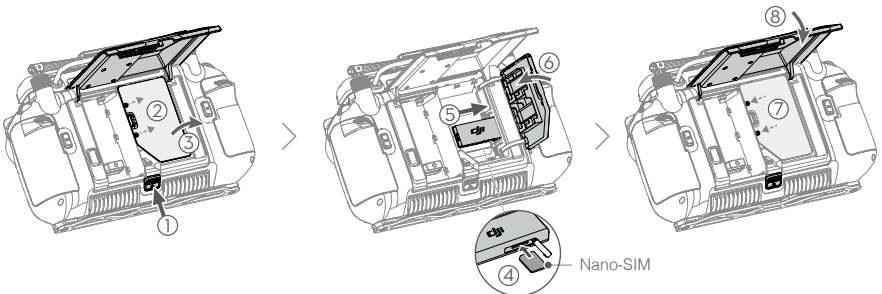

## Mounting the RTK Dongle

When adding points with the remote controller to plan the operation area, attach the RTK dongle connector (for DJI RC Plus) and RTK dongle to the remote controller for more precise positioning.

1. Mount the RTK dongle connector to the USB-A port on remote controller and tighten the two screws.
2. Mount the RTK dongle to the RTK dongle connector.

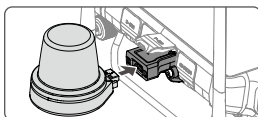

## Adjusting the Antennas

Lift and adjust the antennas. The signal strength of the remote controller is affected by the position of the antennas.

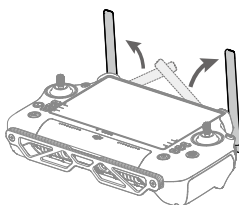

## Activating the Internal Battery

The internal battery must be charged before using for the first time. Connect the 65W portable charger to the USB-C port on the remote controller and connect the charger to a power outlet. The battery level LEDs will start to flash to indicate that the internal battery is activated.

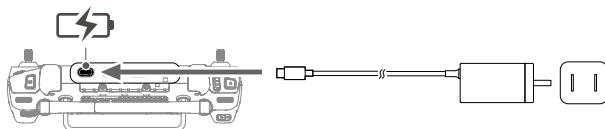

## Pre-Flight Checklist

1. Make sure the remote controller and aircraft battery are fully charged. The pesticides required are adequate.
2. Make sure the spray tank and Intelligent Flight Battery are firmly in place.
3. Make sure all parts are mounted securely.
4. Make sure all cables are connected properly and firmly.





5. Make sure propellers are securely mounted, that there are no foreign objects in or on the motors and propellers, that the propeller blades and arms are unfolded, and the arm locks are firmly tightened.
6. The FPV camera and binocular vision system are clean and in good condition.
7. Make sure the spraying system is not blocked in any way.
8. Make sure the sprinkler hoses are clear from bubbles. Discharge any bubbles as they may affect the performance of the sprinkler.

## System Starting



1. Press the power button on the remote controller and then press and hold to power on the remote controller. Make sure that DJI Agras is open.
2. Press the power button on the Intelligent Flight Battery and then press and hold to power on the aircraft.
3. Check the home screen in DJI Agras to make sure that the aircraft is connected to the remote controller.
4. If using RTK for positioning, make sure that the RTK signal source is correctly set (D-RTK 2 Mobile Station or Network RTK service). Go to Operation View in the app, tap  and select RTK to view and set.  
Set the RTK signal source to None if RTK positioning is not in use. Otherwise, the aircraft is not able to take off when there is no differential data.
5. Wait for satellites to be searched, make sure that there is a strong GNSS signal, and make sure the aircraft heading measurement using the dual antennas is ready. (If the dual antennas are not ready after waiting for an extended period, move the aircraft to an open area with a strong GNSS signal.)

## Calibrating the Flow Meter

Make sure to calibrate the flow meter before using for the first time. Otherwise, the spraying performance may be adversely affected.

1. Fill the spray tank with approximately 2 L of water.
2. In the app, go to Operation View, tap , then , and tap Calibration on the right side of the flow meter calibration section.
3. Tap Start Calibration and calibration will start automatically. The result of the calibration will be displayed in the app when completed.
  - After calibrating successfully, users can proceed with the operation.
  - If calibration fails, tap “?” to view and resolve the problem. Recalibrate once the problem is resolved.

---

 During calibration, tap , then  to cancel. If the calibration is cancelled, the accuracy of the flow meter is based on the data before the calibration was started.

---



## When to Recalibrate

1. Using a liquid of a different viscosity.
2. The error between the actual value and the theoretical value of the completed area is more than 15%.

## Calibrating the Compass

- ⚠ • It is important to calibrate the compass. The calibration result affects the flight safety. The aircraft may malfunction if the compass is not calibrated.
- DO NOT calibrate the compass where there is a chance of strong magnetic interference. This includes areas where there are utility poles or walls with steel reinforcements.
- DO NOT carry ferromagnetic materials with you during calibration such as keys or mobile phones.
- After calibrating successfully, the compass may be abnormal when you place the aircraft on the ground. This may be because of underground magnetic interference underground. Move the aircraft to another location and try again.

Calibrate the compass when prompted by the app. It is recommended to calibrate the compass with an empty tank.

1. Tap , then , move the slider to the bottom, and select Advanced Settings, then IMU and Compass Calibration. Tap Calibration in the compass calibration section.
2. Hold the aircraft horizontally and rotate it 360° around a vertical axis with the aircraft approximately 1.2 m above the ground. Calibration is completed when the app displays that calibration was successful.
3. If the app displays a tilted aircraft, it indicates that the horizontal calibration failed. Users should tilt the aircraft and rotate it horizontally. Calibration is completed when the app displays that calibration was successful. To reduce the number of rotations required, the aircraft should be tilted at least 45°.

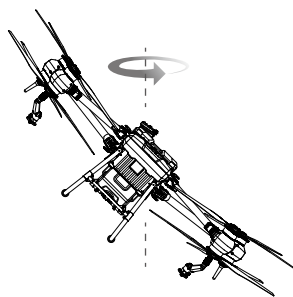
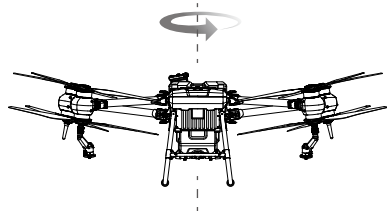

## Takeoff/Landing

The Combination Stick Command (CSC) listed below is used to start and stop the motors. Make sure you perform the CSC in one continuous motion. The motors begin to accelerate at an idle speed. Release both sticks simultaneously. Take off immediately once the motors are spinning, or else the aircraft may lose balance, drift, or even takeoff by itself and risk causing damage or injury.

## Takeoff

Perform a Combination Stick Command (CSC) and push the throttle stick up to take off.

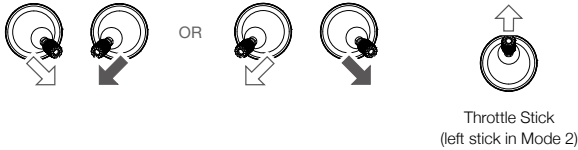

## Landing

To land, pull down on the throttle stick to descend until the aircraft touches the ground. There are two methods to stop the motors.

Method 1: when the aircraft has landed, push and hold the throttle stick down. The motors will stop after three seconds.

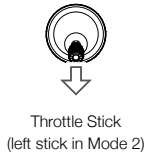

Method 2: when the aircraft has landed, push the throttle stick down, and perform the same CSC that was used to start the motors. Release both sticks once the motors have stopped.











- Spinning propellers can be dangerous. Stay away from spinning propellers and motors. DO NOT start the motors in confined spaces or where there are people nearby.
- Maintain control of the remote controller as long as the motors are running.
- DO NOT stop the motors mid-flight unless in an emergency situation where doing so will reduce the risk of damage or injury.
- It is recommended to use Method 1 to stop the motors. When using Method 2 to stop the motors, the aircraft may roll over if it is not completely grounded. Use Method 2 with caution.
- After landing, power off the aircraft before turning off the remote controller.

## Cruise / Maneuvering Flight

### Operating the Aircraft

This section explains how to control the orientation of the aircraft through the remote controller. Control can be set to Mode 1, Mode 2, or Mode 3. For example, the following description uses Mode 2:

Remote Controller (Mode 2)	Aircraft (● Indicates nose direction)	Remarks
<p>Left Stick</p> 		<p><b>Throttle Stick:</b> Move the left stick vertically to control the elevation of the aircraft.</p> <p>Push up to ascend and push down to descend. Use the left stick to take off when the motors are spinning at an idle speed. The aircraft hovers in place if the stick is in the center position. The further the stick is pushed away from the center position, the faster the aircraft changes elevation.</p>
<p>Left Stick</p> 		<p><b>Yaw Stick:</b> Move the left stick horizontally to control the heading of the aircraft.</p> <p>Push left to rotate the aircraft counterclockwise and push right to rotate clockwise. The aircraft hovers in place if the stick is in the center position. The further the stick is pushed away from the center position, the faster the aircraft rotates.</p>
<p>Right Stick</p> 		<p><b>Pitch Stick:</b> Move the right stick vertically to control the pitch of the aircraft.</p> <p>Push up to fly forwards and press down to fly backwards. The aircraft hovers in place if the stick is in the center position. Push the stick further for a larger pitch angle and faster flight.</p>
<p>Right Stick</p> 		<p><b>Roll Stick:</b> Move the right control stick horizontally to control the roll of the aircraft.</p> <p>Push the stick left to fly left and right to fly right. The aircraft hovers in place if the stick is in the central position. Push the stick further for a larger roll angle and faster flight.</p>

## Flight Modes

The aircraft will fly in N-mode (Normal) by default. Users can switch between flight modes by toggling the Flight Mode switch on the remote controller when A-mode is enabled in the app.

**N-mode/F-mode (Normal):** The aircraft utilizes GNSS or the RTK module for positioning. When the GNSS signal is strong, the aircraft uses GNSS for positioning. When the RTK module is enabled and the differential data transmission is strong, it provides centimeter-level positioning. It will revert to A-mode when the GNSS signal is weak or when the compass experiences interference.

**S-mode (mapped to A-mode, Attitude):** GNSS is not used for positioning and the aircraft can only maintain altitude using the barometer. The flight speed in A-mode depends on its surroundings such as the wind speed.

### Attitude Mode Warning



In A-mode, the aircraft cannot position itself and is easily affected by its surroundings, which may result in horizontal shifting. Use the remote controller to position the aircraft.

Maneuvering the aircraft in A-mode can be difficult. Avoid flying in confined spaces or in areas where the GNSS signal is weak. Otherwise, the aircraft will enter A-mode, leading to potential flight risks. Land the aircraft in a safe place as soon as possible.

## Mapping Operation Modes



After the boundary points of the task area have been added, the app will automatically produce a task route. The aircraft will perform the mapping operation along the route and take photos for the mapping task area. The app will reconstruct an HD map using the photos after the flight so that users can plan a field on the HD map.

### Operation Procedure

1. Go to Operation View in the app, tap the mode switch button on the upper left, and select Route Mapping on the Mapping panel.
2. Tap  at the bottom right of the screen and select Area Route or Boundary Route. In Area Route, mapping and reconstruction will be performed for the whole task area to help users check the current status of the area. In Boundary Route, mapping and reconstruction will be performed for the boundary of the task area only, which takes a shorter time.
3. Tap  in middle of the right screen to select the mode for adding points. Crosshair is set by default.
4. Drag the map and tap Add to add a point at the crosshairs.



If Add Point with RC or Add Point with Aircraft is selected, walk with the remote controller to the desired position or fly the aircraft to the desired position and tap Add.

5. Edit boundary points: Tap the added boundary point to select it and then drag to move the point. Tap twice to delete.
6. Adjust the route direction:
  - a. Drag the  icon near the route to adjust the flight direction of the planned route. Tap the icon to show the Fine Tuning menu and adjust.
  - b. Tap one of the boundaries to select it and then tap it twice to align the route direction with the selected boundary.
7. Tap  to save.

8. Tap  and move the slider to launch the aircraft. The aircraft will fly automatically along the route to perform the mapping task. Check the progress on the upper right of the screen in the app.
9. The aircraft completes the flight and lands. Wait for the reconstruction to complete. The reconstructed map will be displayed on the original map.



- If the mapping operation is paused or stopped during flight and a new mapping field is added, users can only view the paused or stopped operation in the operation list, and the operation cannot be resumed.
  - If the user exits a mapping operation during reconstruction, select the operation in the operation list and tap  to restart reconstruction.
- 

## Reconstruction Result Application

### Field Planning

After reconstruction, tap Plan Field to plan a field on the HD map. The steps are the same as planning a field in Route operation mode. Users can also tap  to cancel the current selection and start a new mapping operation.

### Field Identifying

1. After reconstruction is completed, tap Identify Field. The app will identify and mark the boundary of fields as well as obstacles.
2. When adjustment for the boundary of a field is required, tap to select the field and tap Boundary Tuning to edit the boundary points, such as adjusting point position and adding points. The operations are the same as editing a field in Route operation mode. Tap Confirm after edit.
3. Adjust boundary for other fields if necessary.
4. If the identification results meet the corresponding operation scenarios, select one or multiple fields and tap Save to save the fields to the field list in Route operations. Users can easily use the fields in the Route operation mode.

## Spraying Operation Modes



Spraying operation modes include Route, A-B Route, Manual, Manual Plus, and Fruit Tree operation modes. Use the mode switch button in the app to switch between modes. Select the desired mode for spray according to the operation scenarios.

### Route Operation Mode



In Route operation mode, after planning a field, adding obstacles, and setting parameters, the app will intelligently produce a task route based on the input of the user. Apply and start an operation and the aircraft will fly along the task route automatically. Once prescription maps are added after an operation is applied, the aircraft will perform variable rate fertilization according to the information included in the maps. The aircraft supports connection routing and operation resumption, as well as the altitude stabilization and obstacle avoidance functions of the binocular vision system and active phase array radars. Use the app to adjust the spray amount and flight speed. Route operation mode is recommended for large spray areas.

### Field Planning

1. Go to Operation View in the app, tap the mode switch button on the upper left, and select Route in the Agriculture panel.

2. Tap  on the bottom right and tap  in the middle of the right screen to select the mode for adding points and the type of point. The following description uses Crosshair as an example.
3. Add boundary points: Select Boundary Point as the type of point, drag the map, and tap Add to add a point at the crosshairs.



- A more accurate map is required to add points using the crosshairs. It is recommended to use the HD map reconstructed in a Mapping operation or select a map source in HD Second-layer Map in  under  to improve the accuracy of the added points.
- If Add Point with RC is selected, walk with the remote controller to the desired position and tap Add. If the RTK dongle is mounted to the remote controller for adding points, make sure that RTK positioning is enabled. Go to , tap RTK to select the RTK signal source, and complete configuration. Wait until the system status bar on the upper left of the screen turns green, indicating that RTK positioning is in use.
- If Add Point with Aircraft is selected, fly the aircraft to the desired position and tap Add.

4. Mark any obstacles:

Use one of the two methods below to mark any obstacles in or outside a target field. Obstacles that are marked outside of the task area during field planning will be avoided when planning a connection route for Connection Routing. Refer to Connection Routing for more information.

- ① Select Obstacle as the type of point, drag the map, and tap Add to add a point at the crosshairs.
- ② Select Round as the type of point. A red circle will appear on the map. Tap the center of the circle to select the obstacle and drag to adjust the position. Select the red point on the circumference of the obstacle and drag to adjust the radius.

5. Tap , name the field, choose the crop, and save. The newly added field will be displayed in the field list.

**Field Editing**

Select a field in the field list and tap  to enter Edit mode.

1. Edit boundary points

Move: Tap and drag to move the point.

Delete: Tap twice to delete a point.

2. Edit Obstacles

Tap the obstacle to select and edit it.



For polygonal obstacles, follow the Edit Boundary Points instructions to edit the added points around the obstacle. For circular obstacles, tap the center of the circle to select the obstacle and drag to adjust the position. Select the red point on the circumference of the obstacle and drag to adjust the radius.

3. Users can add more boundary points or obstacles. The steps are the same as for field planning.

4. Tap  to save.

**Performing an Operation**

1. Place the aircraft on open, flat ground with the rear of the aircraft facing you. Power on the remote controller and then the aircraft.

2. Tap Start on the home screen of the app to enter Operation View. Tap the mode switch button on the upper left and select Route in the Agriculture panel.
3. Tap > on the left and select a field in the field list.
4. Tap  to edit the field again.
5. Tap  to apply the field.
6. Operation Settings

Set parameters in the Task tab in the menu on the left of the screen. Users can select a spraying template or set the spray amount, flight speed, line spacing (the distance between two neighboring lines), and height above the vegetation accordingly.

If Auto Route Spacing Adjustment is enabled in Advanced Settings under Aircraft Settings, fine tuning will be applied automatically after the user has adjusted the value of the line spacing. This will adapt the route to be more aligned with the task area. The spacing value displayed may vary slightly from the user input.

## 7. Route Settings

The app produces a task route automatically after the field is applied. The green point on the route indicates the start point while the yellow point indicates the end point. The route settings are as follows.

Route Direction:

- a. Drag the  icon near the route to adjust the flight direction of the planned route. Tap the icon to show the Fine Tuning menu and adjust.
- b. Tap one of the boundaries to select it and then tap it twice to align the route direction with the selected boundary.

Start Point: Tap Start Point on the right, select a boundary point and confirm. The start point of the route will change to a location close to the selected boundary point.

Connection Point: Drag the map and tap Connection Point on the right to add a connection point at the crosshairs. Connection points and Connection Routing can be used to adjust the connection route to circumvent obstacles that were not marked during field planning. Refer to the descriptions below for more information on Connection Routing.

Rectify Offset: Tap Rectify Offset and adjust the route position using the Fine Tuning buttons.

## 8. Add Prescription Maps

Tap  on the field and select a prescription map from the list for a preview. Each area of the field on the map will be displayed in a color corresponding to the quantity of material to be sprayed or spread. Tap OK to apply the selected prescription map to the field.

9. Tap , check the aircraft status and task settings, set an appropriate Connection Routing/RTH Altitude, and move the slider to launch the aircraft. The aircraft will perform the operation automatically.



- The Connection Routing and RTH altitude and speed can be adjusted under Pre-Task Auto Check and Aircraft Settings. If it is adjusted in one location, it will automatically be updated in the other location too.
  - Users can enable or disable Connection Route Altitude in Pre-Task Auto Check or Aircraft Settings. When enabled, the aircraft will fly to the first waypoint at the pre-set Connection Route altitude and return to the flight route with this altitude after the operation is paused and resumed. When disabled, the aircraft will arrive at the first waypoint with the pre-set height above the vegetation.
-



- 
- ⚠ • Only take off in open areas and set an appropriate auto-takeoff height according to the operating environment.
  - The operation is automatically cancelled if the motors are started before beginning the operation. You will need to recall the operation in the task list.
  - Once started, the aircraft flies to the starting point of the route and locks its heading in the direction of the first turning point for the duration of the flight route. During operation, users cannot control the aircraft heading via the control stick.
  - The aircraft does not spray while flying along route spacing, but automatically sprays while flying along the rest of the route. Users can adjust the spray amount, flying speed, and the height above vegetation in the app.
  - An operation can be paused by moving the control stick slightly. The aircraft will hover and record the breakpoint, and then the aircraft can be controlled manually. To continue the operation, select it again from the Executing tag in the field list, and the aircraft will return to the breakpoint automatically and resume the operation. Pay attention to aircraft safety when returning to a breakpoint.
  - Users can set the action the aircraft will perform after the operation is completed in the app.
- 

## Connection Routing

---

- 📄 **Connection Routing:** refers to the procedure where the aircraft flies from the current position to the task route. Only available in Route and Fruit Tree operation modes.
- 

Connection Routing returns the aircraft from its current position to the task route and automatically avoids any obstacles that were marked outside of the task area during field planning. Users can add connection points, which the aircraft must fly through on the connection route to circumvent the obstacles that were not marked during field planning.

1. It is recommended to mark all obstacles inside or outside of the task area during field planning. After entering or resuming an operation, the connection route calculated by Connection Routing will be displayed on the map automatically.
2. Drag the map to align the crosshair to the desired position and tap Connection Point to add a connection point in the crosshair position.
3. Perform an operation, and the aircraft flies along the connection route including through any connection points that have been marked along the way.

## A-B Route Operation Mode

In A-B Route operation mode, the aircraft travels along a pre-planned route. Operation resumption and data protection are available, as well as the altitude stabilization and obstacle avoidance functions of the binocular vision system and active phase array radars. Use the app to adjust the flying speed and spray amount. A-B Route operation mode is recommended for large, triangular, or rectangular spray areas.

### Operation Route

The aircraft travels along a planned square zig-zag route after recording turning points A and B. Under optimal working conditions, obstacle avoidance is available and the aircraft maintains the same distance from the vegetation. The length of the dotted lines, called route spacing, can be adjusted in the app. If users adjust the heading for points A and B after the points are recorded, the turning angles for the turning points of the operation route will change according to the preset heading for points A and B. The shape of the operation route will also change, for example, as Route L' and Route R' in the figure below.

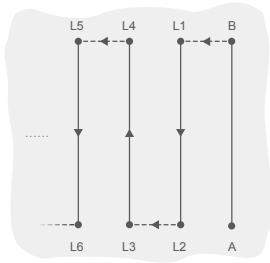

Route L

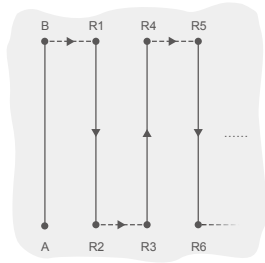

Route R

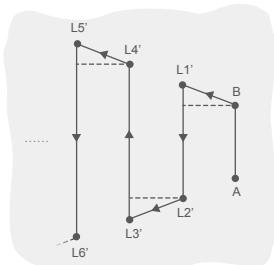

Route L'

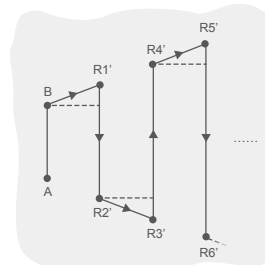

Route R'

····· Route Spacing  
• Turning Point

Legend

**Operation Procedure**

- ⚠ • Maintain VLOS of the aircraft at all times.
- Make sure that the GNSS signal is strong. Otherwise, A-B Route operation mode may be unreliable.

- ☀ • Make sure to inspect operating environments before flying.

Make sure that the GNSS signals are strong and the screen shows Ready to GO (GNSS) or Ready to GO (RTK).

1. Enter A-B Route Operation Mode  
Go to Operation View in the app, tap the mode switch button on the upper left, and select A-B Route.
2. Set the Operation Parameters  
In the parameter settings on the left of the screen, users can select a spraying template or set the spray amount, flight speed, line spacing, and height above the vegetation accordingly.
3. Record Points A and B in Order  
Fly the aircraft to the starting point, depicted as Point A or B, hover, and tap Point A or B onscreen or press the preset customizable button on the remote controller. Point A or B will appear on the map after it is recorded. If the heading for Point A or B is required to be adjusted, the heading for Point A should be adjusted after Point A is recorded and then users can record Point B and adjust the heading for Point B.

- 
- ⚠ • The aircraft sprays automatically when flying from Point A to Point B.
  - Points A and B cannot be recorded if the spray tank is empty or the flying speed of the aircraft is higher than 0.4 m/s.
  - Make sure to record Point A before Point B, and that the distance between Point A and B is more than 1 m.
  - Users cannot adjust the position of Point A or B after they have been recorded. Start a new A-B Route operation if adjustment of Point A or B is required.
  - For optimal performance, it is recommended to keep the direction of Point A to B parallel to one side of the polygonal spray area.
- 

#### 4. Adjust angle for Point A and B

After Point A or B is recorded, tap Adjust A or B Heading onscreen, and move the yaw stick on the remote controller. The heading of the aircraft corresponds to the heading for Point A or B that is indicated by a dotted line on the screen. Tap Adjust A or B Heading again to set the current heading for Point A or B. There are angle limits for adjusting the heading for Point A or B. Take note of any prompts in the app when operating.

- 
- ⚠ The heading for Point A or B cannot be set when the rotating speed of the aircraft's heading is higher than 15°/s.
- 

#### 5. Select the Route

After Point A and B are recorded, the app produces Route R or Route R' by default. Tap  to switch to Route L or Route L'.

#### 6. Performing an Operation

Tap  and move the slider to start the operation.

- 
- ☀ • Users can adjust the spray amount, flight speed and height above the vegetation during operation while the line spacing cannot be adjusted.
  - Users cannot control the aircraft heading via the control stick during the operation.
  - When using the control sticks to control the aircraft in A-B Route operation mode, the aircraft automatically switches to Manual operation mode, completes the corresponding flight behavior, and then hovers. To resume the operation, tap Resume onscreen. The aircraft resumes flying along the operation route. Refer to Operation Resumption for more information.
  - Even though the heading of the aircraft cannot be adjusted, use the control sticks to avoid obstacles if the obstacle avoidance function of the radar module is disabled. Refer to Manual Obstacle Avoidance for more information.
  - During the operation, the aircraft does not spray liquid while flying along the route parallel to the line from A to B, but automatically sprays liquid while flying along the other parts of the route.
- 

## Manual Operation Mode

Tap the mode switch button on the upper left in the app and select M to enter Manual operation mode. In this mode, you can control all the movements of the aircraft, spray liquid via the spray button of the remote controller, and adjust the spray rate via the dial. Refer to Controlling the Spraying System for more information. Manual operation mode is ideal when the operating area is small.

## Manual Plus Operation Mode

Tap the mode switch button on the upper left and select M+ to enter Manual Plus operation mode. In this mode, the heading is locked and all other movements can be manually controlled. Users can disable the M+ heading lock in the parameter settings. Use the buttons in the app to steer the aircraft left or right. Under optimal working conditions, the radar module maintains the spraying distance between the aircraft and vegetation if altitude stabilization function is enabled. Manual Plus operation is ideal for irregularly-shaped operating areas.

1. In the parameter settings on the left, users can select a spraying template, set the spray amount, flight speed, line spacing and height above the vegetation, and lock the heading.
2. Tap  and move the slider to launch the aircraft.
3. Tap the corresponding buttons in the app and the aircraft will fly to the left or right at the preset distance for line spacing. The aircraft automatically sprays when accelerating forward, backward or diagonally, but does not spray when flying sideward.

---



 During an operation, users can adjust the spray amount, flight speed, and height above the vegetation but not the line spacing.

---

## Fruit Tree Operation Mode

Users can obtain information on Fruit Tree operations by either downloading it from DJI Agras Intelligent Cloud or importing it from a microSD card and use the operation in Fruit Tree operation mode.

### Download/Import Fruit Tree Operations Information

1. Download from DJI Agras Intelligent Cloud: Go to the home screen in the DJI Agras app and tap  to enter the task management screen. Tap  and select desired Fruit Tree operations in the pop-up window and download.
2. Import from the microSD card: Insert the microSD card with the planning data from DJI Terra into the microSD card slot on the remote controller. Next, go to the home screen of DJI Agras. Select the data in the pop-up window and import it. To view the data, go to  task management on the home screen.
3. The downloaded or imported operations will be displayed in the operation list in Fruit Tree operation mode.

### Performing an Operation

1. Place the aircraft on open, flat ground with the rear of the aircraft facing you. Power on the remote controller and then the aircraft.
2. Tap Start in the home screen of the app to enter Operation View. Tap the mode switch button on the upper left of the screen and select Fruit Tree in the Agriculture panel.
3. Tap > on the left and select the operation in the operation list.
4. Tap  to apply the operation.
5. Operation Settings

In the parameter settings on the left, set the spray amount or flow rate, flight speed, and height above the vegetation.

Rotary Spraying can be enabled or disabled for operations involving tree crown center points. Once enabled, the aircraft will rotate automatically and spray the pesticide when arriving at a tree crown center.

For operations with no tree crown center points, users can select the method for calculating the task area.

6. Connection Point: Drag the map and tap Connection Point on the right to add a connection point at the crosshairs. Connection points and Connection Routing can be used to adjust the connection route to circumvent obstacles that were not marked during field planning. Connection Routing works the same as in Route operation mode.
7. Rectify Offset: Tap Rectify Offset and adjust the route position using the Fine Tuning buttons. If calibration points are included in the route, place the aircraft at one of the calibration points and tap Rectify Aircraft Position.
8. Tap , check the aircraft status and task settings, set an appropriate Connection Routing/RTH Altitude, and move the slider to launch the aircraft. The aircraft will perform the operation automatically.

 The Connection Routing and RTH altitude and speed can be adjusted under Pre-Task Auto Check and Aircraft Settings. If it is adjusted in one location, it will automatically be updated in the other location too.

- 
- Only take off in open areas and set an appropriate auto-takeoff height according to the operating environment.
  - The operation is automatically cancelled if the motors are started before beginning the operation. You will need to recall the operation in the task list.
  - Once started, the aircraft flies to the starting point of the route and locks its heading in the direction of the first turning point for the duration of the flight route. During operation, users cannot control the aircraft heading via the control stick.
  - The aircraft does not spray while flying along route spacing, but automatically sprays while flying along the rest of the route. Users can adjust the spray amount, flying speed, and the height above vegetation in the app.
  - An operation can be paused by moving the control stick slightly. The aircraft will hover and record the breakpoint, and then the aircraft can be controlled manually. To continue the operation, select it again from the Executing tag in the field list, and the aircraft will return to the breakpoint automatically and resume the operation. Pay attention to aircraft safety when returning to a breakpoint.
  - Users can set the action the aircraft will perform after the operation is completed in the app.

## System Shutdown

After landing, push the throttle stick down and hold to stop the motors. Press the power button and then press and hold to power off the aircraft and remote controller.

## Post-Flight Inspection

1. Make sure that the aircraft is powered off. Remove the battery from the aircraft and store it properly.
2. Check the aircraft structure, clean the dirt and dust, and replace any loose or damaged parts.
3. Make sure that there is no residue in the spray/spread tank and the whole spraying/spreading system.
4. Make sure that the aircraft is folded correctly for transportation.
5. Make sure that the battery connector on the aircraft is clean and dry.

# Emergency Procedures

## General Information

This chapter introduces how to handle the aircraft or remote controller if one of the following emergencies occurs.

## Engine Failure

If one or more motors fail during flight, the aircraft will calculate the remaining propulsion according to factors such as the status of the propulsion system, aircraft weight, and flight environment. Two possible scenarios may occur:

1. Remaining propulsion is sufficient: the aircraft will continue to fly in a stable condition with remaining propulsion.
2. Remaining propulsion is insufficient: the aircraft will spin and perform a controlled descent.

Afterward, it is recommended that users land the aircraft manually and check and repair the aircraft immediately.

## Fire

A prompt will appear in the app and the flight controller will reduce the power of the aircraft when the flight battery temperature is too high. The battery will be locked for future use if it exceeds the temperature threshold during flight and cannot be used again after landing.

Follow the instructions below if the flight battery catches fire.

1. If the battery catches fire when the battery is being charged using a battery station or generator, make sure personal safety is guaranteed, power off the battery station or generator immediately, and disconnect the battery from the charging device. If the battery catches fire when the battery is in the aircraft, make sure personal safety is guaranteed and disconnect the battery from the aircraft immediately.
2. Transfer the flammable materials surrounding the battery to a safe distance of more than 5 m away.
3. If the fire is small, use materials such as large amount of sand to cover the location of the fire and pour cold water to cool the battery until there is no longer any smoke being produced. With the help of fire-resistant gloves or other protective tools that allow users to avoid direct contact with the battery, move the battery to a container with enough water to fully immerse the battery and add an appropriate amount of salt to help fully discharge the battery. Leave the container in a cool place for more than 72 hours and take out the battery and discard it.
4. If the fire is large, double check that there are no flammable materials surrounding the fire, extend the safety distance to more than 10 m, and evacuate any people in the surrounding environment. Wait until the battery burns out and the fire is extinguished in order to avoid any further accidents.

## Loss of C2 Link

The aircraft supports Failsafe RTH function.



**Home Point:** The default home point is the first location where your aircraft received strong GNSS signals . Note that the white GNSS icon requires at least four bars before the signal is strong.

**RTH:** RTH brings the aircraft back to the last recorded home point.

## Failsafe RTH

-  The aircraft will RTH or hover if the remote controller signal is lost. The action can be set in the app. Failsafe RTH will only be available if RTH is set.

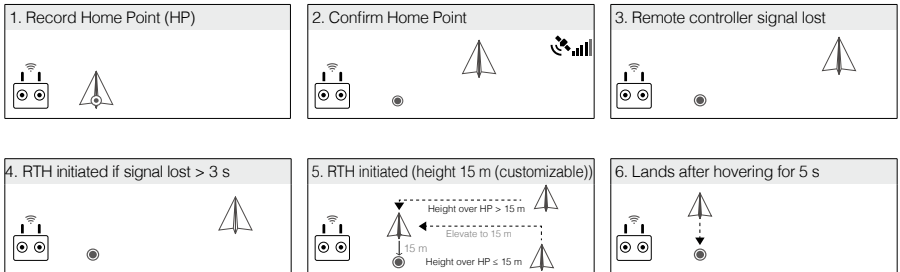

Failsafe RTH is automatically activated if the remote controller signal is lost for more than three seconds, provided that the home point has been successfully recorded, the GNSS signal is strong  and the RTK module is able to measure the heading of the aircraft. The RTH continues if the remote controller signal is recovered, and users can control the aircraft using the remote controller. Press the RTH button once to cancel RTH and regain control of the aircraft.

### RTH Illustration



-  If RTH is triggered during Route operations, the aircraft can plan a flight path for RTH to circumvent the obstacles added when planning a field.

### RTH Safety Notices

	<p>The aircraft will not enter RTH if RTH is triggered when the aircraft is within a 3m radius of the Home Point, but the remote controller will still sound an alert. Exit RTH to cancel the alert.</p>
	<p>The aircraft cannot return to the home point when the GNSS signal is weak (the GNSS icon displays red) or is unavailable.</p>

### Obstacle Avoidance During RTH

In an optimal operating environment, obstacle avoidance during RTH is available. If there is an obstacle within 20 m of the aircraft, the aircraft decelerates and then stops and hovers. The aircraft will exit the RTH procedure and wait for further commands.

### Landing Protection Function

Landing Protection activates during auto landing. The procedure is as follows:

- After arriving at the home point, the aircraft descends to a position 3 m above the ground and hovers.
- Control the pitch and roll sticks to adjust the aircraft position and make sure the ground is suitable for landing.

3. Pull down the throttle stick or follow the onscreen instructions in the app to land the aircraft.

-  When using fixed RTK positioning, the aircraft will land directly instead of entering Landing Protection. Landing Protection is still available if the aircraft is performing a fruit tree route operation planned using DJI Terra.
- 

## Loss of Navigation Systems

When using fixed RTK positioning, the aircraft will switch to GNSS if RTK is unavailable during flight. If GNSS is also unavailable, the aircraft will switch to Attitude (ATTI) mode automatically to stabilize its attitude and a prompt will appear in the app to remind users to fly with caution and land as soon as possible.

## Control Station Failures

Control station failures include the following scenarios.

1. Control signal is lost: the aircraft will enter Failsafe RTH if Failsafe RTH is enabled in the app. Refer to Loss of C2 Link for more information about Failsafe RTH. The aircraft action can also be set to hovering in place until the aircraft lands with critically low battery level or landing directly.
2. The app crashes during automatic operations while the control signal is normal: in this case, the C2 link between the aircraft and the remote controller is in good condition, so the aircraft will continue performing the current operation until landing is triggered by critically low battery level. Users can exit from Route operations by moving the control stick slightly and control the aircraft manually.

## Flyaway

The flight telemetry of the aircraft will be displayed on the screen of the remote controller during flight. If the aircraft flies away during operation, users can search for the aircraft according to the location of the aircraft and remote controller displayed on the map in the app. If the GNSS signal of the aircraft is lost after the aircraft flies away then the aircraft will not be displayed on the map in the app. Users can estimate the location of the aircraft to its last location, flight speed, and heading before the loss of the GNSS signal.

## Reporting Requirements

Users are responsible to inform DJI of any event of an uncontrolled crash or flyaway within 2 business days through DJI Support, a DJI authorized dealer, or other means and shall upload the flight data related to the event. See the instructions of flight data upload from <https://youtu.be/X8sVce69z5g>



# Weight and Balance and Equipment List

Users can remove the spray tank and install the spreading system for spreading operations. The center of gravity is within the ranges listed in the Center of Gravity Limitations section whether a spray tank or spreading system is used.

## Handling, Servicing and Instructions for Maintenance and Continued Airworthiness

### Ground Handling

1. Make sure that the aircraft is powered off. Remove the battery from the aircraft and store it properly.
2. Check the aircraft structure, clean the dirt and dust, and replace any loose or damaged parts.
3. Clean the residue in the spray/spread tank and the spraying/spreading system and keep the system dry.
4. Make sure that the aircraft is folded correctly for transportation or storage.
5. Make sure that the battery connector on the aircraft is clean and dry.

### Disassembly, Storage, and Reassembly

The tank, propellers, and sprinklers on the aircraft can be disassembled. Follow the instructions below to disassemble, reassemble, and store them. Make sure to remove the Intelligent Flight Battery from the aircraft before disassembly and reassembly.

#### Tank

##### Disassembly

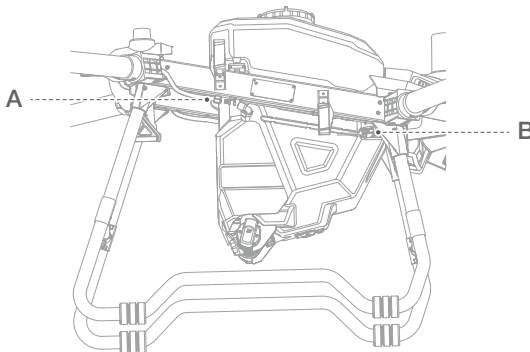

**A.**

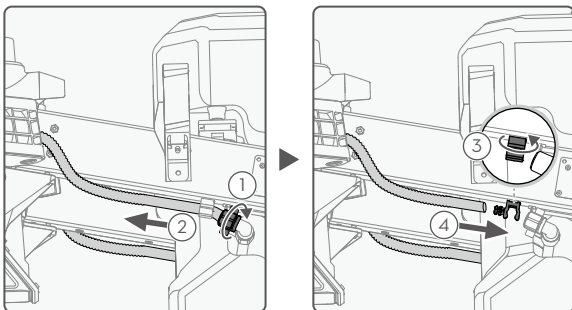

**B.**

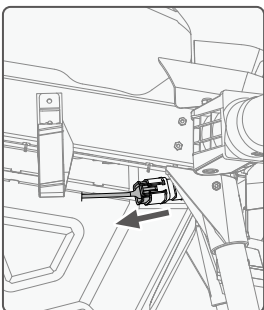

**C.**

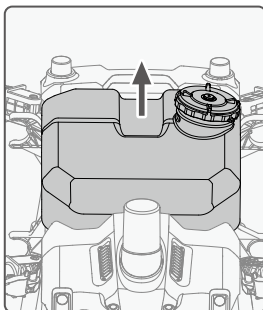

1. On the aircraft, locate the hoses on either side of the spray tank. Loosen the nut on the hose ①, take the hose out of the hose clamp ②, rotate the clamp ③, and connect the hose to the protrusion on the clamp ④. (Figure A)

Note: After the hose is removed, make sure to tighten the hose nut on the spray tank hose connector to avoid losing the nut.

2. Locate the spraying system cable in front of the right landing gear on the aircraft. Unplug the cable from the connector. Operate with caution to avoid damaging the cable. (Figure B)
3. Lift and remove the spray tank on the aircraft. (Figure C)

**Reassembly**

Follow the steps of disassembly in reverse order for reassembly.

## Propellers

### Disassembly

1. Remove the two M5×15 propeller blade screws using a proper hex key.
2. Remove the propeller adapter, the four Teflon gaskets, and two rubber washers above and under each propeller blade.

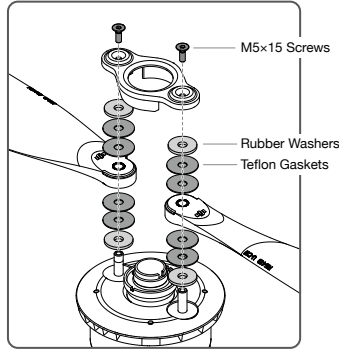

### Reassembly

Identify the CW or CCW marks on the propeller blades and motors. Make sure to assemble the parts with the same mark. T40 users can identify the upper (U) and lower (L) propeller blades with the corresponding letter at the end of the model number on each propeller.

1. Place the one rubber washer and then two Teflon gaskets onto one of the mounting hole on the motor. Place the propeller blade and then two Teflon gaskets and one rubber washer.
2. Follow the same steps for the other mounting hole on the motor.
3. Place the propeller adapter on the top.
4. Insert the two M5×15 screws to the mounting holes and tighten to secure the propeller blades.

## Sprinklers

### Disassembly

1. Rotate and remove the screw and cover at the bottom of the sprinkler. Remove the centrifugal disk module.
2. Separate the upper and lower disks.
3. Remove the washer on the lower disk.

### Reassembly

Follow the steps of disassembly in reverse order for reassembly.

## Storage

### Aircraft Storage

1. Keep the aircraft and parts clean and dry and store them in a cool dry place. Recommended storage temperature (when the tank, flow meter, pumps, and hoses are empty): between -20° and 40° C (-4° and 104° F).
2. Make sure to keep the small parts properly to avoid loss. Small parts, such as cables and straps, are dangerous if swallowed. Keep all parts out of reach of children and animals.
3. Remove or empty the tank when not in use to avoid damaging the landing gear.
4. Remove the battery from the aircraft when stored.

### Battery Storage

Disconnect the battery from the aircraft and check if there is any buildup in the battery port.

---

- ⚠ Power off and disconnect the battery from the aircraft or other devices during transportation.
  - Keep batteries out of the reach of children and animals. Seek professional medical support immediately if children swallow parts of the battery.
  - If the battery level is critically low, charge the battery to a power level of 40% to 60%. DO NOT store a battery with a low power level for an extended period. Otherwise, the performance will be negatively affected.
  - DO NOT leave the battery near heat sources such as a furnace or heater. DO NOT leave the battery inside a vehicle on hot days.
  - The battery must be stored in a dry environment.
  - DO NOT place the battery near explosive or hazardous material or near metal objects such as eyeglasses, watches, jewelry, and hairpins.
  - DO NOT attempt to transport a battery that is damaged or has more than 30% power. Discharge the battery to 30% or lower before transportation.
  - Make sure the battery is placed on a flat surface to avoid damage to the battery from sharp objects.
- 
- ❗ If storing the battery for more than three months, it is recommended to store the battery in a battery safety bag in an environment at a temperature range from -20° to 40° C (-4° to 104° F).
  - DO NOT store the battery for an extended period after fully discharging. Doing so may over-discharge the battery and cause irreparable damage to the battery cell.
  - If a battery with a low power level has been stored for an extended period, the battery will be in deep hibernation mode. Charge to wake the battery.
  - Disconnect the battery from the aircraft if you intend to store the battery for an extended period.
-

## Charging / Conditioning / Replacing Batteries

### Charging Batteries

Use the T40/T20P Intelligent Charger to charge the batteries.

1. Connect the battery to the charger.

- If using Agras T40, connect the charging cable to the air-cooled heat sink before putting the battery into the heat sink. The charger starts to charge the battery. The four LEDs of the battery blink in sequence while charging. Remove the battery when the four LEDs turn solid or off and put another battery inside the heat sink to charge.

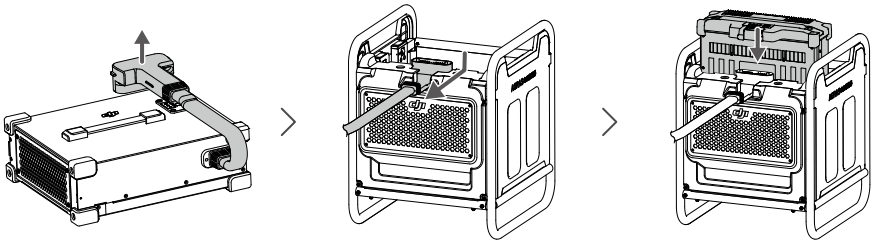

- If using Agras T20P, connect the charging cable to the battery directly. The charger starts to charge the battery. The four LEDs of the battery blink in sequence while charging. Remove the battery when the four LEDs turn solid or off and connect another battery to charge.

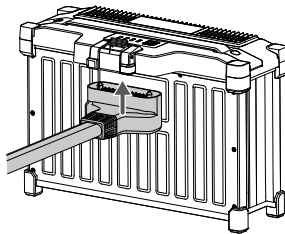

2. Connect the two single-phase AC power cables. Connect the single-phase AC power cable (charger) to the charger and then connect the single-phase AC power cable (power supply) to a power outlet.

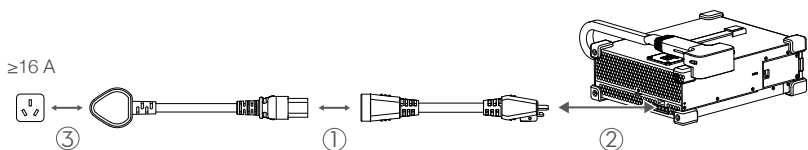

3. Once charging is complete, the charging channel status LED on the charger will be solid green. Disconnect the battery from the charger.

---

 Users can also use the D12000i Multifunctional Inverter Generator or D6000i Multifunctional Inverter Generator to charge the flight battery. Refer to the corresponding user guide for more information.

---

## Conditioning Batteries

---

-  • If the battery is not used for an extended period, the battery life may be reduced.
  - Fully charge and discharge the battery at least once every three months to ensure the performance of the battery.
  - If a battery has not been charged or discharged for five months or more, the battery will no longer be covered by the warranty.
- 

## Replacing Batteries

The battery should not be used again if any accident occurs. Users should replace the battery immediately. See details below.

1. DO NOT use swollen, leaking, or damaged batteries.
2. DO NOT use a battery that has been dropped.
3. If the battery falls into water while inserted in an aircraft during flight, take it out immediately, and put it in a safe and open area. DO NOT use the battery again.
4. If the battery cannot be discharged completely, replace the battery and contact a professional battery recycle company for assistance on disposal.

## Maintenance Program

### Operator Performing List

1. Clean all parts of the aircraft at the end of each day of spraying after the aircraft returns to a normal temperature. DO NOT clean the aircraft immediately after operations are completed.
  - a. Fill the spray tank with clean water or soapy water and spray the water through the sprinklers until the tank is empty. Repeat the step two more times.
  - b. Remove the spray tank strainer and sprinklers to clean them and clear any blockage. Afterwards, immerse them in clean water for 12 hours.
  - c. Make sure that the aircraft structure is completely connected so that it can be washed directly with water. It is recommended to use a spray washer filled with water to clean the aircraft body and wipe with a soft brush or wet cloth before removing water residue with a dry cloth.
  - d. If there is dust or pesticide liquid on the motors, propellers, or heat sinks, wipe them with a wet cloth before cleaning the remaining water residue with a dry cloth.
  - e. Store the cleaned aircraft in a dry environment.
2. Wipe the surface and screen of the remote controller with a clean wet cloth that has been wrung out with water daily after operations.

3. Inspect the aircraft every 100 flights or after flying for over 20 hours:
  - a. Check for and replace worn propellers.
  - b. Check for loose propellers. Replace propellers and propeller washers if needed.
  - c. Check for aging plastic or rubber parts.
  - d. Check for poor atomization of the sprinklers. Clean the centrifugal disks of the sprinklers thoroughly. Replace the centrifugal disks in the case of severely poor atomization.
  - e. Replace the spray tank strainer.
4. Keep the protective cover of the radar module clean. Clean the surface with a soft damp cloth and air dry before using again.
5. Regularly wipe off dirt on the gimbal of the FPV camera. Keep the FPV camera and the cameras of the binocular vision system clean. Make sure that the aircraft is powered off. First remove any larger pieces of grit or sand then wipe the lens with a clean, soft cloth to remove dust or other dirt.

### Notice

1. In the event of a crash or collision, make sure to thoroughly inspect every part of the aircraft and make any necessary repairs and replacements before your next flight. If you have any problems or questions, contact DJI Support or a DJI authorized dealer.
2. DO NOT attempt to repair the aircraft if any parts are damaged. Contact DJI Support or a DJI authorized dealer for professional maintenance services. The T40/T20P Drone Recommended Maintenance Cycle table in the Supplements section lists the recommended maintenance cycle and item maintenance performed by DJI authorized dealers only.
3. When a replacement part is required, make sure to purchase the new part from a DJI authorized dealer only.

Find the dealer information from <https://www.dji.com/where-to-buy/agriculture-dealers>

# Supplements

This chapter introduces the specifications of the whole system, additional functions of the aircraft, the operation of optional equipment, and other relevant information.

## Specifications

### T40

Aircraft	
Model	3WWDZ-40A
Weight	38 kg (excl. battery) 50 kg (inc. battery)
Max Takeoff Weight <sup>†1</sup>	Max takeoff weight for spraying: 90 kg (at sea level) Max takeoff weight for spreading: 101 kg (at sea level)
Max Diagonal Wheelbase	2,184 mm
Dimensions	2,800×3,150×780 mm (arms and propellers unfolded) 1,590×1,930×780 mm (arms unfolded and propellers folded) 1,125×750×850 mm (arms and propellers folded)
Hovering Accuracy Range (with strong GNSS signal)	D-RTK enabled: Horizontal: ±10 cm, Vertical: ±10 cm D-RTK disabled: Horizontal: ±60 cm, Vertical: ±30 cm (radar module enabled: ±10 cm)
Operating Frequency <sup>†2</sup>	2.4000-2.4835 GHz, 5.725-5.850 GHz
Transmitter Power (EIRP)	2.4 GHz: <20 dBm (SRRC/CE/MIC), <33 dBm (FCC) 5.8 GHz: <33 dBm (SRRC/FCC), <14 dBm (CE)
RTK/GNSS Operating Frequency	GPS L1/L2, GLONASS F1/F2, BeiDou B1/B2, Galileo E1/E5 GNSS: GPS L1, GLONASS F1, Galileo E1, BeiDou B1
Hovering Time <sup>†3</sup>	No payload: 18 min (takeoff weight of 50 kg with a 30Ah battery) Fully loaded for spraying: 7 min (takeoff weight of 90 kg with a 30Ah battery) Fully loaded for spreading: 6 min (takeoff weight of 101 kg with a 30Ah battery)
Max Configurable Flight Radius	2,000 m
Max Wind Resistance	6 m/s
Operating Temperature	0° to 45° C (32° to 113° F)
Propulsion System	
Motors	
Stator Size	100×33 mm
KV	48 rpm/V
Power	4000 W/rotor
Propellers	
Diameter	54 in (1371.6 mm)
Rotors Quantity	8



**Dual Atomized Spraying System**

**Spray Tank**

Volume Full: 40 L

Operating Payload<sup>(1)</sup> Full: 40 kg

**Sprinklers**

Model LX8060SZ

Quantity 2

Droplet Size 50-500 μm

Max Effective Spray Width<sup>(4)</sup> 11 m (at a height of 2.5 m above the crops with a flight speed of 7 m/s)

**Delivery Pumps**

Type Magnetic drive impeller pump

Max Flow Rate 6 L/min × 2

**Active Phased Array Omnidirectional Radar**

Model RD2484R

Terrain Follow Max slope in Mountain mode: 30°

Obstacle sensing range (horizontal): 1.5-50 m

FOV: Horizontal 360°, Vertical ±45°

Working conditions: flying higher than 1.5 m over the obstacle at a speed no more than 7 m/s

Safety limit distance: 2.5 m (distance between the front of propellers and the obstacle after braking)

Obstacle avoidance direction: omnidirectional obstacle avoidance in the horizontal direction.

Obstacle Avoidance<sup>(5)</sup>

Obstacle sensing range (upward): 1.5-30 m

FOV: 45°

Working conditions: available during takeoff, landing, and ascent when an obstacle is more than 1.5 m above the aircraft.

Safety limit distance: 3 m (distance between the top of aircraft and the obstacle after braking)

Obstacle avoidance direction: upward

Operating Frequency 24.05-24.25 GHz (NCC/FCC/MIC/KCC/CE)

Power Consumption 15 W

Transmitter Power (EIRP) <20 dBm (NCC/FCC/MIC/KCC/CE)

Operating Voltage DC 15V

Operating Temperature 0° to 45° C (32° to 113° F)

**Active Phased Array Backward and Downward Radar**

Model RD2484B

Altitude Detection<sup>(5)</sup> Altitude detection range: 1-45 m  
Stabilization working range: 1.5-30 m

Obstacle Avoidance <sup>[5]</sup>	<p>Obstacle sensing range (backward): 1.5-30 m                      FOV: Horizontal <math>\pm 60^\circ</math>, Vertical <math>\pm 25^\circ</math>                      Working conditions: available during takeoff, landing, and ascent when the distance between the rear of aircraft and the obstacle is more than 1.5 m and the aircraft speed is no more than 7 m/s.                      Safety limit distance: 2.5 m (distance between the front of propellers and the obstacle after braking)                      Obstacle avoidance direction: backward</p>
Operating Frequency	24.05-24.25 GHz (NCC/FCC/MIC/KCC/CE)
Power Consumption	4 W
Transmitter Power (EIRP)	<20 dBm (NCC/FCC/MIC/KCC/CE)
Operating Voltage	DC 15V
Operating Temperature	0° to 45° C (32° to 113° F)
<b>Binocular Vision System</b>	
Measurement Range	0.4-25 m
Effective Sensing Speed	$\leq 10$ m/s
FOV	Horizontal: 90°, Vertical: 106°
Operating Environment	Adequate light and discernible surroundings
<b>Remote Controller</b>	
Model	RM700B
GNSS	GPS + Galileo + BeiDou
Screen	7.02-in LCD touchscreen, with a resolution of 1920×1200 pixels, and high brightness of 1200 cd/m <sup>2</sup>
Operating Temperature	-20° to 50° C (-4° to 122° F)
Storage Temperature Range	Less than one month: -30° to 45° C (-22° to 113° F)
	One to three months: -30° to 35° C (-22° to 95° F)
	Three months to one year: -30° to 30° C (-22° to 86° F)
Charging Temperature	5° to 40° C (41° to 104° F)
Internal Battery Chemical System	LiNiCoAlO <sub>2</sub>
Internal Battery Runtime	3 hours 18 minutes
External Battery Runtime	2 hours 42 minutes
Charging Type	It is recommended to use a locally certified USB-C charger at a maximum rated power of 65 W and maximum voltage of 20 V such as the DJI 65W Portable Charger.
Charging Time	2 hours for internal battery or internal and external battery (when remote controller is powered off and using a standard DJI charger)
<b>O3 Agras</b>	
Operating Frequency <sup>[2]</sup>	2.4000-2.4835 GHz, 5.725-5.850 GHz
Transmitter Power (EIRP)	2.4 GHz: <33 dBm (FCC), <20 dBm (CE/SRRC/MIC) 5.8 GHz: <33 dBm (FCC), <14 dBm (CE), <23 dBm (SRRC)

Max Transmission Distance	7 km (FCC), 5 km (SRRC), 4 km (MIC/CE) (unobstructed, free of interference, and at an altitude of 2.5 m)
<b>Wi-Fi</b>	
Protocol	Wi-Fi 6
Operating Frequency <sup>[2]</sup>	2.4000-2.4835 GHz, 5.150-5.250 GHz, 5.725-5.850 GHz
Transmitter Power (EIRP)	2.4 GHz: <26 dBm (FCC), <20 dBm (CE/SRRC/MIC) 5.1 GHz: <26 dBm (FCC), <23 dBm (CE/SRRC/MIC) 5.8 GHz: <26 dBm (FCC/SRRC), <14 dBm (CE)
<b>Bluetooth</b>	
Protocol	Bluetooth 5.1
Operating Frequency	2.4000-2.4835 GHz
Transmitter Power (EIRP)	<10 dBm

- [1] The DJI Agras app will intelligently recommend the payload weight limit for the tank according to the current status and surroundings of the aircraft. Do not exceed the recommended payload weight limit when adding material to the tank. Otherwise, the flight safety may be affected.
- [2] 5.8 and 5.1 GHz frequencies are prohibited in some countries. In some countries, the 5.1 GHz frequency is only allowed for use indoors.
- [3] Hovering time acquired at sea level with wind speed lower than 3 m/s and a temperature of 25° C (77° F). For reference only. The data may vary depending on the environment. Actual results shall be as tested.
- [4] The spray width depends on the actual operation scenarios.
- [5] The effective sensing range varies depending on the material, position, shape, and other properties of the obstacle.

## T20P

Aircraft	
Model	3WWDZ-20A
Weight	26 kg (excl. battery) 32 kg (inc. battery)
Max Takeoff Weight <sup>(1)</sup>	Max takeoff weight for spraying: 52 kg (at sea level) Max takeoff weight for spreading: 58 kg (at sea level)
Max Diagonal Wheelbase	2,190 mm
Dimensions	2,800×3,125×640 mm (arms and propellers unfolded) 1,565×1,915×640 mm (arms unfolded and propellers folded) 1,077×620×670 mm (arms and propellers folded)
Hovering Accuracy Range (with strong GNSS signal)	D-RTK enabled: Horizontal: ±10 cm, Vertical: ±10 cm D-RTK disabled: Horizontal: ±60 cm, Vertical: ±30 cm (radar module enabled: ±10 cm)
Operating Frequency <sup>(2)</sup>	2.4000-2.4835 GHz, 5.725-5.850 GHz
Transmitter Power (EIRP)	2.4 GHz: <20 dBm (SRRC/CE/MIC), <33 dBm (FCC) 5.8 GHz: <33 dBm (SRRC/FCC), <14 dBm (CE)
RTK/GNSS Operating Frequency	GPS L1/L2, GLONASS F1/F2, BeiDou B1/B2, Galileo E1/E5 GNSS: GPS L1, GLONASS F1, Galileo E1, BeiDou B1
Hovering Time <sup>(3)</sup>	No payload: 14.5 min (takeoff weight of 32 kg with a 13Ah battery) Fully loaded for spraying: 7 min (takeoff weight of 52 kg with a 13Ah battery) Fully loaded for spreading: 6 min (takeoff weight of 58 kg with a 13Ah battery)
Max Configurable Flight Radius	2,000 m
Max Wind Resistance	6 m/s
Operating Temperature	0° to 45° C (32° to 113° F)
Propulsion System	
Motors	
Stator Size	100×33 mm
KV	48 rpm/V
Power	4000 W/rotor
Propellers	
Diameter	54 in (1371.6 mm)
Rotors Quantity	4
Dual Atomized Spraying System	
Spray Tank	
Volume	Full: 20 L
Operating Payload <sup>(1)</sup>	Full: 20 kg

<b>Sprinklers</b>		
Model	LX8060SZ	
Quantity	2	
Droplet Size	50-500 µm	
Max Effective Spray Width <sup>69</sup>	7 m (at a height of 2.5 m above the crops with a flight speed of 7 m/s)	
<b>Delivery Pumps</b>		
Type	Magnetic drive impeller pump	
Max Flow Rate	6 L/min × 2	
<b>Active Phased Array Omnidirectional Radar</b>		
Model	RD2484R	
Terrain Follow	Max slope in Mountain mode: 30°	
Obstacle Avoidance <sup>69</sup>	Obstacle sensing range (horizontal): 1.5-50 m FOV: Horizontal 360°, Vertical ±45° Working conditions: flying higher than 1.5 m over the obstacle at a speed no more than 7 m/s Safety limit distance: 2.5 m (distance between the front of propellers and the obstacle after braking) Obstacle avoidance direction: omnidirectional obstacle avoidance in the horizontal direction.	
	Obstacle sensing range (upward): 1.5-30 m FOV: 45° Working conditions: available during takeoff, landing, and ascent when an obstacle is more than 1.5 m above the aircraft. Safety limit distance: 3 m (distance between the top of aircraft and the obstacle after braking) Obstacle avoidance direction: upward	
	Operating Frequency	24.05-24.25 GHz (NCC/FCC/MIC/KCC/CE)
	Power Consumption	4 W
	Transmitter Power (EIRP)	<20 dBm (NCC/FCC/MIC/KCC/CE)
Operating Voltage	DC 15V	
Operating Temperature	0° to 45° C (32° to 113° F)	
<b>Active Phased Array Backward and Downward Radar</b>		
Model	RD2484B	
Altitude Detection <sup>69</sup>	Altitude detection range: 1-45 m Stabilization working range: 1.5-30 m	
Obstacle Avoidance <sup>69</sup>	Obstacle sensing range (backward): 1.5-30 m FOV: Horizontal ±60°, Vertical ±25° Working conditions: available during takeoff, landing, and ascent when the distance between the rear of aircraft and the obstacle is more than 1.5 m and the aircraft speed is no more than 7 m/s. Safety limit distance: 2.5 m (distance between the front of propellers and the obstacle after braking) Obstacle avoidance direction: backward	

Operating Frequency	24.05-24.25 GHz (NCC/FCC/MIC/KCC/CE)
Power Consumption	15 W
Transmitter Power (EIRP)	<20 dBm (NCC/FCC/MIC/KCC/CE)
Operating Voltage	DC 15V
Operating Temperature	0° to 45° C (32° to 113° F)
<b>Binocular Vision System</b>	
Measurement Range	0.4-25 m
Effective Sensing Speed	≤10 m/s
FOV	Horizontal: 90°, Vertical: 106°
Operating Environment	Adequate light and discernible surroundings
<b>Remote Controller</b>	
Model	RM700B
GNSS	GPS + Galileo + BeiDou
Screen	7.02-in LCD touchscreen, with a resolution of 1920×1200 pixels, and high brightness of 1200 cd/m <sup>2</sup>
Operating Temperature	-20° to 50° C (-4° to 122° F)
Storage Temperature Range	Less than one month: -30° to 45° C (-22° to 113° F) One to three months: -30° to 35° C (-22° to 95° F) Three months to one year: -30° to 30° C (-22° to 86° F)
Charging Temperature	5° to 40° C (41° to 104° F)
Internal Battery Chemical System	LiNiCoAlO <sub>2</sub>
Internal Battery Runtime	3 hours 18 minutes
External Battery Runtime	2 hours 42 minutes
Charging Type	It is recommended to use a locally certified USB-C charger at a maximum rated power of 65 W and maximum voltage of 20 V such as the DJI 65W Portable Charger.
Charging Time	2 hours for internal battery or internal and external battery (when remote controller is powered off and using a standard DJI charger)
<b>O3 Agras</b>	
Operating Frequency <sup>2)</sup>	2.4000-2.4835 GHz, 5.725-5.850 GHz
Transmitter Power (EIRP)	2.4 GHz: <33 dBm (FCC), <20 dBm (CE/SRRC/MIC) 5.8 GHz: <33 dBm (FCC), <14 dBm (CE), <23 dBm (SRRC)
Max Transmission Distance	7 km (FCC), 5 km (SRRC), 4 km (MIC/CE) (unobstructed, free of interference, and at an altitude of 2.5 m)
<b>Wi-Fi</b>	
Protocol	Wi-Fi 6
Operating Frequency <sup>2)</sup>	2.4000-2.4835 GHz, 5.150-5.250 GHz, 5.725-5.850 GHz
Transmitter Power (EIRP)	2.4 GHz: <26 dBm (FCC), <20 dBm (CE/SRRC/MIC) 5.1 GHz: <26 dBm (FCC), <23 dBm (CE/SRRC/MIC) 5.8 GHz: <26 dBm (FCC/SRRC), <14 dBm (CE)

**Bluetooth**

Protocol	Bluetooth 5.1
Operating Frequency	2.4000-2.4835 GHz
Transmitter Power (EIRP)	<10 dBm

- [1] The DJI Agras app will intelligently recommend the payload weight limit for the tank according to the current status and surroundings of the aircraft. Do not exceed the recommended payload weight limit when adding material to the tank. Otherwise, the flight safety may be affected.
- [2] 5.8 and 5.1 GHz frequencies are prohibited in some countries. In some countries, the 5.1 GHz frequency is only allowed for use indoors.
- [3] Hovering time acquired at sea level with wind speed lower than 3 m/s and a temperature of 25° C (77° F). For reference only. The data may vary depending on the environment. Actual results shall be as tested.
- [4] The spray width depends on the actual operation scenarios.
- [5] The effective sensing range varies depending on the material, position, shape, and other properties of the obstacle.

## Operation Resumption

When exiting a Route, A-B Route, or Fruit Tree operation, the aircraft will record a breakpoint. The Operation Resumption function allows the user to pause an operation temporarily to refill the spray tank, change the battery, or avoid obstacles manually. Afterwards, resume operation from the breakpoint.

### Recording a Breakpoint

If GNSS signals are strong, a breakpoint will be recorded in the following scenarios during an operation. If GNSS signals are weak, the aircraft will enter Attitude mode and exit the current operation. The last position where GNSS signals were strong will be recorded as a breakpoint.

1. Tap the Pause or End button on the lower right corner of the screen. Note: tapping the End button during an A-B Route operation does not cause the aircraft to record a breakpoint. The operation ends immediately and cannot be resumed.
2. Initialize RTH.
3. Push the pitch or roll stick in any direction on the remote controller.
4. Obstacle detected. The aircraft brakes and enters obstacle avoidance mode.
5. Radar module error detected when its obstacle avoidance function is enabled.
6. The aircraft reaches its distance limit, or the aircraft is close to a GEO zone.
7. Empty tank.
8. The aircraft enters low-battery landing mode.
9. If the option "Continue operation if remote control signal is lost" is disabled in Aircraft Settings, and the aircraft disconnects from the remote controller, the aircraft will record a breakpoint after it performs the action preset for when signals are lost.



- Make sure that the GNSS signal is strong when using the Operation Resumption function.
- Otherwise, the aircraft cannot record and return to the breakpoint.
- The breakpoint is updated as long as it meets one of the above conditions.
- If RTK positioning is not in use and the operation is paused for longer than 25 minutes during an A-B Route operation, the system will automatically switch to Manual operation mode and erase the breakpoint.

### Resuming Operation

1. Exit an operation through one of the above methods. The aircraft will record the current location as the breakpoint.
2. Fly the aircraft to a safe location after operating the aircraft or removing the conditions for recording a breakpoint.
3. Return Route

For Route operations, Flight-Efficient Operation Resumption becomes available if any of the following conditions are met. The app will calculate the optimal return point according to the breakpoint and the aircraft location to reduce the flying distance when carrying more payload. Make sure that Flight-Efficient Operation Resumption is enabled in Advanced Settings under Aircraft Settings before using the function.

- The aircraft will land on the ground after the operation is paused.
- Exit an operation by tapping the end button and then start this operation again in the Executing tag in the operation list.



For Route operations that do not meet the conditions mentioned above, as well as operations in other modes, the return route is as follows.

The default return route is to fly back to the breakpoint. Users can also select a return point from the list of return points and breakpoint on the screen, which means the aircraft will return to the task route following a perpendicular line. After exiting an operation by tapping the end button, resume the operation by selecting the Executing tag in the operation list to apply the operation again and select the return route.

4. Tap Resume in the lower right corner of the screen and the aircraft will fly to the task route by following the selected return route and continue spraying. For Route and Fruit Tree operations, Connection Routing is supported for return flights.
5. If obstacle avoidance is required when returning to the route, users can control the aircraft forward, backward, and sideward. Refer to the Manual Obstacle Avoidance section for more information.

### Typical Applications

In Route, A-B Route, or Fruit Tree operation mode, users can control the aircraft forward, backward, and sideward, avoiding obstacles along the operation route, or in an emergency such as when the aircraft is experiencing abnormal behavior. The following instructions describe how to avoid obstacles manually:

### Manual Obstacle Avoidance

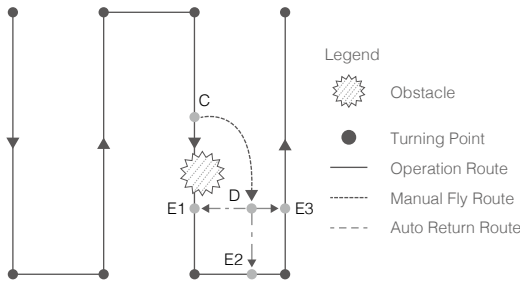

#### 1. Exiting a Route, A-B Route, or Fruit Tree operation

In these modes, when using the control sticks to control the aircraft forward, backward, or sideward, the aircraft automatically switches the current mode to Manual operation mode, pauses the operation, records the current position as a breakpoint (Point C), completes the corresponding flight behavior, and hovers.



**⚠** When pushing the control sticks to exit the operation, the aircraft requires a braking distance. Make sure that there is a safe distance between the aircraft and any obstacles.

#### 2. Avoiding an Obstacle

After switching to Manual operation mode, users can control the aircraft to avoid the obstacle from Point C to D.

#### 3. Resuming Operation

Select one of the three return points marked as E1, E2, or E3. Tap resume and the aircraft flies from the point marked D to the selected return point following a perpendicular line.

- 
-  • The amount of selectable return points is related to the position of the aircraft. Select according to the app display.
  - Make sure that the aircraft has completely avoided the obstacle before resuming operation.
  - In the event of an emergency, make sure that the aircraft is operating normally and fly the aircraft manually to a safe area to resume operation.
- 
-  Repeat the instructions above to exit and resume operation in the event of an emergency when returning to the route, such as whenever obstacle avoidance is required.
- 

## System Data Protection

In Route, A-B Route, or Fruit Tree operation mode, the System Data Protection feature enables the aircraft to retain vital system data such as operation progress and breakpoints after the aircraft is powered off to replace a battery or refill the spray tank. Follow the instructions in Operation Resumption to resume the operation after restarting the aircraft.

During Route operations, in situations such as when the app crashes or the remote controller disconnects from the aircraft, the breakpoint will be recorded by the flight controller and recovered automatically in the app once the aircraft is reconnected. If recovery is not performed automatically, users can perform the operation manually. Go to Advanced Settings under Aircraft Settings in the app and tap Continue Unfinished Task. Recall the operation in the Executing tag in the operation list.

## Empty Tank Warning

### Profile



The aircraft calculates the empty tank and refill points according to the preset remaining liquid level threshold, current remaining liquid level, aircraft status, and operation parameters and displays the empty tank point on the map. In Route, A-B Route, and Fruit Tree operations, users can set the action the aircraft will perform for empty tank point.

- 
-  • The empty tank point will not be displayed on the map if the tank is not calculated to run out before the end of the task route.
  - For Route operations, when adding liquid to the spray tank or adjusting the operation parameters, the empty tank point will update dynamically on the operating route according to the amount of added liquid and the adjusted settings.
- 

### Usage

1. In Aircraft settings, enable the display of empty tank point and set the empty tank action.
2. When an empty tank warning appears in the app, the sprinklers automatically turn off and the aircraft performs the preset empty tank action.
3. Land the aircraft and stop the motors. Refill the spray tank and tightly secure the cover.
4. Select an operation mode and continue the operation.

## Return to Home (RTH)

 **Home Point:** The default home point is the first location where your aircraft received strong GNSS signals . Note that the white GNSS icon requires at least four bars before the signal is strong.

**RTH:** RTH brings the aircraft back to the last recorded home point.

There are three types of RTH: Smart RTH, Low Battery RTH, and Failsafe RTH.

### Smart RTH

Press and hold the RTH button on the remote controller when GNSS is available to enable Smart RTH. Both Smart and Failsafe RTH use the same procedure. With Smart RTH, you may control the altitude of the aircraft to avoid collisions when returning to the home point. Press the RTH button once or push the pitch stick to exit Smart RTH and regain control of the aircraft.

### Low Battery RTH

Low Battery RTH is only available in Route and A-B Route operations. If the Low Battery Action is set to RTH in the Aircraft Battery settings in the app, the aircraft will pause the operation and enter RTH automatically when the aircraft battery level reaches the low battery threshold. During RTH, users can control the altitude of the aircraft to avoid collisions when returning to the home point. Press the RTH button once or push the pitch stick to exit RTH and regain control of the aircraft.

The aircraft will not enter RTH if the Low Battery Action is set to Warning in the Aircraft Battery settings in the app.

### Failsafe RTH

Refer to Emergency Procedures for more information about Failsafe RTH.







### Updating the Home Point

You can update the home point in DJI Agras during flight. There are two ways to set a home point:

1. Set the current coordinates of the aircraft as the home point.
2. Set the current coordinates of the remote controller as the home point.

 Make sure the space above the remote controller's GNSS module (located inside the place above the flight switch mode) is not obstructed and that there are no tall buildings around when updating the home point.

Follow the instructions below to update the home point:

1. Go to DJI Agras and enter Operation View.
2. Tap , then , and select  in Home Point Location settings to set the current coordinates of the aircraft as the home point.
3. Tap , then , and select  in Home Point Location settings to set the current coordinates of the remote controller as the home point.
4. The aircraft status indicators blink green to indicate that the new home point has been set successfully.

## Low Battery and Low Voltage Warnings

The aircraft features a low battery warning, critical low battery warning, and critical low voltage warning.

1. When the low battery warning prompt appears in the app, fly the aircraft to a safe area and land as soon as possible. Stop the motors and replace the battery. The aircraft will enter RTH automatically after the low battery warning prompt appears in the app if the Low Battery Action is set to RTH in the Aircraft Battery settings.
2. The aircraft will automatically descend and land when the critical low battery warning or critical voltage warning (battery voltage lower than 47.6 V) prompt appears in the app. Landing cannot be cancelled.



Users can set the threshold of low battery warnings in the app.

## RTK Functions

The aircraft has an onboard D-RTK. The heading reference of the aircraft from the dual antennas of the onboard D-RTK is more accurate than a standard compass sensor and can withstand magnetic interference from metal structures and high-voltage power lines. When there is a strong GNSS signal, the dual antennas activate automatically to measure the heading of the aircraft.

The aircraft supports centimeter-level positioning to improve agricultural operation when used with the DJI D-RTK 2 Mobile Station. Follow the instructions below to use the RTK functions.

### Enable/Disable RTK

Before each use, make sure that the RTK signal source is correctly set to either D-RTK 2 Mobile Station or Network RTK. Otherwise, RTK cannot be used for positioning. Go to Operation View in the app, tap , and select RTK to view and set.



Set the RTK signal source to None if RTK positioning is not in use. Otherwise, the aircraft is not able to take off when there is no differential data.

### Using with the DJI D-RTK 2 Mobile Station

1. Refer to the D-RTK 2 Mobile Station User Guide for more information about completing the linking between the aircraft and the mobile station and setting up the mobile station.
2. Power on the mobile station and wait for the system to start searching for satellites. The RTK status icon on top of the Operation View in the app shows  to indicate that the aircraft has obtained and used the differential data from the mobile station.

### Using with the Network RTK Service

The Network RTK service uses the remote controller instead of the base station to connect to an approved Network RTK server for differential data. Keep the remote controller on and connected to the internet when using this function.

1. Make sure that the remote controller is connected to the aircraft and has access to the internet.
2. Go to Operation View in the app, tap , and then RTK. Set the RTK signal source to Custom Network RTK, and input the network information.
3. Wait for the remote controller to be connected with the Network RTK server. The RTK status icon on top of the Operation View in the app shows  to indicate that the aircraft has obtained and used the RTK data from the server.

## Aircraft LEDs

There are LEDs on the frame arms marked M1 to M4. The LEDs on frame arms M1 and M2 are front LEDs that blink slowly in red to indicate the front of the aircraft. The LEDs on frame arms M3 and M4 are rear LEDs that blink slowly in green to indicate the rear of the aircraft. All the LEDs are turned off when the aircraft is grounded.

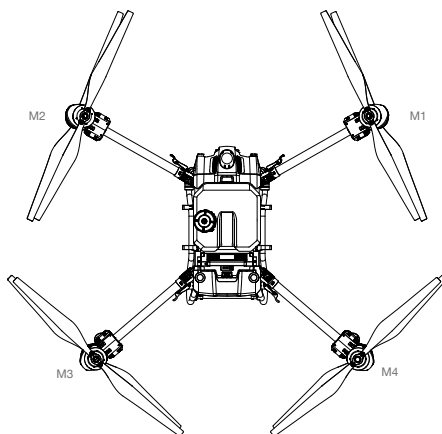

## Updating the Firmware

The firmware of the remote controller, aircraft, and other devices such as the intelligent charger and multifunctional inverter generator can be updated together in the DJI Agras app. Follow the steps below.

1. Power on the remote controller and the aircraft. Make sure that the remote controller has access to the internet via Wi-Fi or the cellular dongle. The firmware file may be large. It is recommended to use Wi-Fi.
2. A prompt appears at the bottom of the home screen in DJI Agras when a new firmware update is available. Tap the prompt to enter the firmware screen.
3. Connect the device to the USB-A port on the remote controller to update the firmware of the intelligent charger or multifunctional inverter generator. Tap the dropdown menu for each device and select the firmware. There will be a check mark on the device displayed in the app when a firmware is selected for the corresponding device. Uncheck the mark to cancel the update.
4. Tap Update All to redirect to the update screen. The app will download the firmware for all selected devices and update automatically.
5. Make sure all the devices are connected to the remote controller and wait for the update to complete. The aircraft front LEDs will blink yellow during an update.
6. The aircraft front indicators will glow solid green after an update is completed. Restart the remote controller and the aircraft manually. If the indicators glow solid red indicating that a firmware update has failed, try running the update again.

## DJI Assistant 2 for MG

Configure settings of the basic parameters, copy flight records, and update aircraft and remote controller firmware in DJI Assistant 2 for MG.

### Installation and Launching

1. Download the DJI Assistant 2 for MG installation file from the T40 or T20P download page:  
<https://www.dji.com/t40/downloads> or <https://www.dji.com/t20p/downloads>
2. Install the software.
3. Launch DJI Assistant 2 for MG.

### Using DJI Assistant 2 for MG

#### Connecting the Aircraft

Connect the USB-C port under the bottom cover on the front of the aircraft to a computer with a USB-C cable, and then power on the aircraft.

---

 Make sure to remove the propellers before using DJI Assistant 2 for MG.

 Remove the waterproof cover on the USB-C port before use. Attach the waterproof cover to the port after use. Otherwise, water may enter the port, causing it to short circuit.

---

#### Firmware Update

A DJI account is required for firmware updates. Login or register an account.

#### Exporting Log

View all the logs of the aircraft and select logs to export.

#### Simulator

Click Open to enter the flight simulation view. Input location and environment parameters and click Configure to save. Click Start Simulation to enter flight simulation practice.

#### Basic Settings

Configure the idle speed of and test the motor.

#### Connecting the Remote Controller

Connect the USB-C port of the remote controller to a computer with a USB-C cable and power on the remote controller.

#### Firmware Update

A DJI account is required for firmware updates. Login or register an account.

#### Exporting Log

View all the logs of the remote controller and select the logs to export.

- 
-  • DO NOT power off the remote controller during the update.
- DO NOT perform the firmware update while the aircraft is in the air. Only carry out the firmware update when the aircraft is on the ground.
- The remote controller may become unlinked from the aircraft after the firmware update. Relink the remote controller and aircraft if necessary.
-

## Intelligent Flight Battery

### Battery Functions

1. **Battery Level Display:** the status LEDs indicate the current battery level. Press the power button to check.
2. **Communication:** battery parameters including the voltage and power level are transmitted to the aircraft to enable the aircraft to take appropriate action when battery parameters change.
3. **Battery Error Self-Diagnosis:** the battery can detect errors such as abnormal voltage, current, and temperature, and issue an alert. The error information will be recorded in the battery.
4. **Short Circuit Detection:** after the battery is inserted into the aircraft and powered on, the battery will first detect if a short circuit exists on the aircraft. If detected, the battery will cut off the power supply to the aircraft to avoid fire.
5. **Charging Error Detection:** errors that occur during charging are indicated by the status LEDs. When an error occurs, wait for the battery to fix the error automatically. For more information, refer to the LED Patterns section.
6. **Auto Balancing:** in certain situations, the battery automatically balances the voltages of the cells.
7. **Auto Discharging:** if fully charged for more than one day, the battery automatically discharges to 97%. After 7 days, it automatically discharges to 60%.
8. **Auto Current Adjustment:** the battery intelligently adjusts the charging current based on the temperature of the battery cells. The battery also supports self-protection based on the environment temperature.
9. **Temperature Control:** the battery ensures the temperature difference between the battery cells are the same and stay within the allowable temperature range.

- 
-  • Refer to the safety requirements listed on the label of the battery before using for the first time. Users accept full responsibility for any violations of the safety requirements stated on the label.
- The product warranty is void if any battery errors occur due to misuse of the battery.
- 

### Using the Battery

Press and then press and hold the power button to power on the battery after it is connected to the aircraft. When the aircraft lands and the motors stop, press and then press and hold the power button to power off the battery, and then disconnect the battery from the aircraft.

- 
-  • DO NOT use the battery near heat sources such as a furnace or heater. DO NOT leave the battery inside a vehicle on hot days.
- DO NOT allow the battery to come into contact with any liquid. DO NOT leave the battery near a source of moisture and DO NOT use the battery in humid environments. Otherwise, the battery may corrode, potentially resulting in the battery catching fire or exploding.
  - DO NOT use swollen, leaking, or damaged batteries. If your battery is abnormal, contact an authorized DJI dealer for further assistance.
  - Make sure the battery is powered off before connecting to or disconnecting from the aircraft. DO NOT connect or disconnect the battery while it is powered on. Otherwise, the power ports may be damaged.
-

- ⚠ • The battery should be used in the temperature range of -5° to 45° C (23° to 113° F). Use of batteries in environments above 50° C (122° F) can lead to fire or an explosion. Use of the battery in temperatures below -5° C (23° F) can negatively affect the performance of the battery. The battery can be used again when it returns to a normal temperature.
  - DO NOT use the battery in strong electrostatic or electromagnetic environments or near high-voltage transmission lines. Otherwise, the battery circuit board may malfunction, which could cause a serious flight hazard.
  - DO NOT disassemble or pierce a battery in any way or it may leak, catch fire, or explode.
  - The electrolytes in the battery are highly corrosive. If any electrolytes make contact with your skin or eyes, immediately wash the affected area with water and see a doctor immediately.
  - DO NOT use a battery that has been dropped. Dispose of the battery as described in the Battery Disposal section.
  - If the battery falls into water while inserted in an aircraft during flight, take it out immediately, and put it in a safe and open area. DO NOT use the battery again and dispose of it properly as described in the Battery Disposal section.
  - DO NOT put the battery in a microwave oven or a pressurized container.
  - DO NOT place the battery on or near wires or other metal objects such as eyeglasses, watches, jewelry, and hairpins. Otherwise, the battery ports may be short-circuited.
  - DO NOT drop or strike batteries. DO NOT place heavy objects on the batteries or station. Avoid dropping batteries.
  - Always use a clean, dry cloth when cleaning the battery terminals.
  - DO NOT fly when the battery power level is below 15% to avoid damage to the battery and flight risks.
  - Make sure the battery is correctly connected. Otherwise, the battery may overheat or even explode due to abnormal charging. Only use approved batteries from authorized dealers. DJI assumes no responsibility for any damaged caused by using batteries that are unapproved.
  - Make sure to lift the battery by the handle.
  - Make sure the battery is placed on a flat surface to avoid damage to the battery from sharp objects.
  - DO NOT place anything on a battery. Otherwise, the battery may be damaged, which may lead to fire hazards.
  - The battery is heavy. Be careful when moving the battery to avoid dropping it. If the battery is dropped and damaged, immediately leave the battery in an open area away from people. Wait 30 minutes and soak the battery in water for 24 hours. After making sure the power has completely run out, dispose of the battery in accordance with local laws.
- 
- ① • Make sure the battery is fully charged before each flight.
  - Immediately land the aircraft if a critical battery level warning appears and replace with a fully charged battery.
  - Before operating in a low-temperature environment, make sure the battery is at least above 5° C (41° F). Ideally, above 20° C (68° F).
-



































## LED Patterns

 The Battery Level Indicators will show the current battery level and status during charging and discharging. The indicators are defined below:

-  LED is on
-  LED is off
-  LED is blinking





















### Checking Battery Level

If the battery is in power saving mode, press the power button once to check the current battery level.

LED1	LED2	LED3	LED4	Battery Level
				88-100%
				75-87%
				63-74%
				50-62%
				38-49%
				25-37%
				13-24%
				0-12%

### LED Patterns During Charging

During charging, the LEDs blink in sequence to indicate the current battery level. All the LEDs will be off after a full charge. **Disconnect the battery when charging is complete, and always use the officially recommended charging device to charge the battery.**

LED1	LED2	LED3	LED4	Battery Level
				0-49%
				50-74%
				75-89%
				90-99%
				100%

### Battery Error LED Patterns

The table below shows battery protection mechanisms and corresponding LED patterns.

LED1	LED2	LED3	LED4	Blinking Pattern	Battery Exception Item
				LED2 and LED4 blink three times per second	Aircraft short circuit
				LED2 blinks twice per second	Overcurrent detected
				LED2 blinks three times per second	The battery system is abnormal
				LED3 blinks twice per second	Overcharged detected
				LED3 blinks three times per second	Charging device over-voltage
				LED4 blinks twice per second	Charging temperature is too low
				LED4 blinks three times per second	Charging temperature is too high
				All 4 LEDs blink fast	The battery is abnormal and unavailable

If a short circuit occurs, unplug the battery, resolve the issue on the aircraft, and plug in the battery.

If the charging temperature is abnormal, wait for the charging temperature to return to normal. The battery will then automatically resume charging without the need to unplug and plug the charging device again.

For other situations, after resolving the issue (overcurrent, excess battery voltage due to overcharging, or excess charging device voltage), press the power button to cancel the LED indicator protection alert and unplug and plug in the charging device again to resume charging.



- DJI does not take any responsibility for damage caused by third-party charging devices.
- DO NOT charge the battery near flammable materials or on flammable surfaces such as carpet or wood. DO NOT leave the battery unattended during charging. There should be a distance of at least 30 cm between the battery station and any charging batteries. Otherwise, the battery station or charging batteries may be damaged by excessive heating and may even lead to a fire hazard.
- The battery temperature will be high after a flight. Place the battery into the DJI Air-Cooled Heat Sink or a third-party air-cooled heat dissipation device to charge it. Otherwise, charging may be disabled. Refer to the DJI Air-Cooled Heat Sink manual document for its usage instructions. Charge the battery at a temperature range of 0° to 60° C (32° to 140° F). The ideal charging temperature range is 22° to 28° C (72° to 82° F). Charging within the ideal temperature range can prolong battery life.
- DO NOT immerse the battery in water to cool it down or when it is charging. Otherwise, the battery cells will corrode causing serious damage to the battery. The user accepts full responsibility for any damage to the battery caused by immersing the battery in water.

- 
- ⚠ • DO NOT charge the battery near heat sources such as a furnace or heater.
  - Regularly check the terminals and battery ports. DO NOT clean the battery using alcohol or other inflammable liquid. DO NOT use a damaged charging device.
  - Keep the battery dry at all times.
- 

- ① • The battery stops charging when charging is complete. It is recommended to disconnect the battery once charging is complete.
  - Make sure the battery is powered off before charging. Otherwise, the battery ports may be damaged.
- 

## Battery Storage and Transportation

Disconnect the battery from the aircraft and check if there is any buildup in the battery port.

- 
- ⚠ • Power off and disconnect the battery from the aircraft or other devices during transportation.
  - Keep batteries out of the reach of children and animals. Seek professional medical support immediately if children swallow parts of the battery.
  - If the battery level is critically low, charge the battery to a power level of 40% to 60%. DO NOT store a battery with a low power level for an extended period. Otherwise, the performance will be negatively affected.
  - DO NOT leave the battery near heat sources such as a furnace or heater. DO NOT leave the battery inside a vehicle on hot days.
  - The battery must be stored in a dry environment.
  - DO NOT place the battery near explosive or hazardous material or near metal objects such as eyeglasses, watches, jewelry, and hairpins.
  - DO NOT attempt to transport a battery that is damaged or has more than 30% power. Discharge the battery to 30% or lower before transportation.
  - Make sure the battery is placed on a flat surface to avoid damage to the battery from sharp objects.
- 

- ① • If storing the battery for more than three months, it is recommended to store the battery in a battery safety bag in an environment at a temperature range from -20° to 40° C (-4° to 104° F).
  - DO NOT store the battery for an extended period after fully discharging. Doing so may over-discharge the battery and cause irreparable damage to the battery cell.
  - If a battery with a low power level has been stored for an extended period, the battery will be in deep hibernation mode. Charge to wake the battery.
  - Disconnect the battery from the aircraft if you intend to store the battery for an extended period.
- 

## Battery Disposal

- 
- ⚠ • Before disposing, make sure to soak the battery in water for 24 hours to completely discharge the battery. Dispose of the battery in specific recycling boxes. DO NOT place the battery in regular waste containers. Strictly follow your local regulations regarding the disposal and recycling of batteries.
- 
- ① • If the battery cannot be discharged completely, DO NOT dispose of the battery in a battery recycling box directly. Contact a professional battery recycle company for assistance.
-

## Battery Maintenance

- ① • DO NOT splash the battery with water. An excessive amount of water will damage the battery.
- DO NOT store the battery when the temperature is outside the range of -20° to 45° C (-4° to 113° F).
- Battery performance will be negatively affected if the battery is not used for an extended period.
- Fully charge and discharge the battery at least once every three months to ensure the performance of the battery.
- If a battery has not been charged or discharged for five months or more, the battery will no longer be covered by the warranty.

## Specifications

Specifications	T40 Intelligent Flight Battery (BAX601-30000mAh-52.22V)	T20P Intelligent Flight Battery (BAX601-13000mAh-52.22V)
Nominal Voltage	52.22 V	
Battery Type	Li-ion	
Battery Chemical System	LiNiMnCoO2	
Discharge Rate	11.5C	
Operating Temperature	-5° to 45° C (23° to 113° F)	
Charging Temperature	0° to 60° C (32° to 140° F)	
Warranty Details	1,500 cycles or 12 months (whichever occurs first)	
IP Rating	IP54 + Board-level potting protection	
Compatible Aircraft	DJI Agras T40, T20P, T30	DJI Agras T20P
Capacity	30 Ah	13 Ah
Energy	1567 Wh	679 Wh
Max Charging Power	9500 W	4200 W
Compatible Charging Device <sup>[1]</sup>	D12000iE Multifunctional Inverter Generator, T40 Intelligent Charger, T30 Intelligent Battery Station <sup>[2]</sup>	D6000i Multifunctional Inverter Generator, T20P Intelligent Charger, T30 Intelligent Battery Station <sup>[2]</sup>
Charging Time for Each Battery <sup>[3]</sup>	Using the D12000iE Multifunctional Inverter Generator: 9-12 min	Using the D6000i Multifunctional Inverter Generator: 9-12 min
Weight	Approx. 12 kg	Approx. 6 kg

[1] Charging devices available for purchase vary by country or region. Consult your local dealers for details.

[2] Firmware update is required to charge the T40/T20P Intelligent Flight Battery.

[3] Charging time was tested in a lab environment at a temperature of 25° C (77° F). For reference only.

## Payload - Spraying System

Equipped with the 2-channel electromagnetic flow meter and continuous liquid level gauge, the spraying system provides users with accurate control of the magnetic drive impeller pumps and dual atomized sprinklers.

## Optional Payload - T40/T20P Spreading System

### Introduction

The T40/T20P Spreading System is compatible with the Agras T40/T20P aircraft with a large spread tank of 70 L and 35 L, respectively, and offers efficient and reliable spreading.

The spreading system has a built-in stirring device to prevent material blockages and improve operating accuracy and reliability. The control module on the spreading system and the weight sensors on the aircraft monitor the weight of the remaining material in the spread tank in real-time to improve the accuracy of the spread rate control and empty tank warnings. The included fenders can block spreading material that flies upward and prevent it from damaging the propellers. The quick-release hopper gate allows for easy maintenance.

Users can configure spreading settings in the DJI Agras app and create specific templates for different materials in order to meet different requirements. The app also provides warning prompts for an empty tank as well as for abnormalities in rotational speed, temperature, and hopper outlet size.

### Installation

- 
- ⚠ • Make sure to remove the Intelligent Flight Battery from the aircraft before installation.
  - Operate with caution to avoid injury caused by sharp or moving mechanical parts.
  - Check the parts on the aircraft and spreading system after installation to make sure that the spinner disk will not damage the cables or any other part during operations.
- 

The T40 Spreading System and T20P Spreading System are similar in appearance, but the spread tanks are different sizes. Unless otherwise specified, the illustrations in this document use the T40 Spreading System as an example.

1. On the aircraft, locate the hoses on either side of the spray tank. Loosen the nut on the hose ①, take the hose out of the hose clamp ②, rotate the clamp ③, and connect the hose to the protrusion on the clamp ④. (Figure A)  
Note: After the hose is removed, make sure to tighten the hose nut on the spray tank hose connector to avoid losing the nut.
2. Locate the spraying system cable in front of the right landing gear on the aircraft. Unplug the cable from the connector. Operate with caution to avoid damaging the cable. (Figure B)
3. Lift and remove the spray tank on the aircraft. (Figure C)
4. Insert the spreading system into the aircraft. (Figure D)
5. Connect the spreading system cable to the connector in step 2 and ensure a firm and accurate connection. (Figure E)

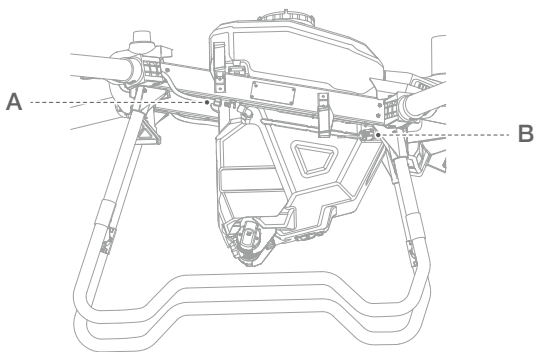

**A.**

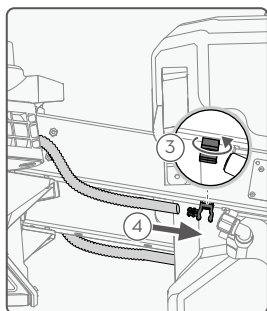
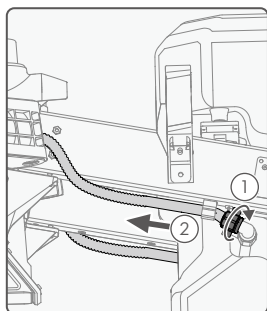

**B.**

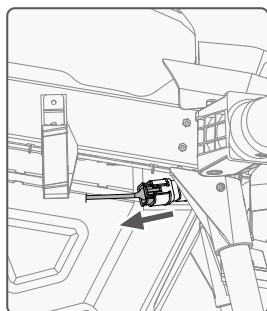

**C.**

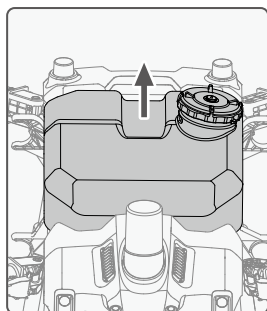

**D.**

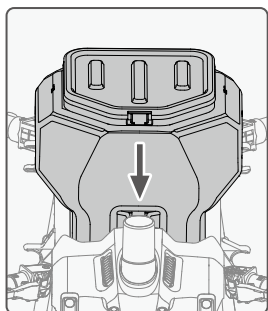

**E.**

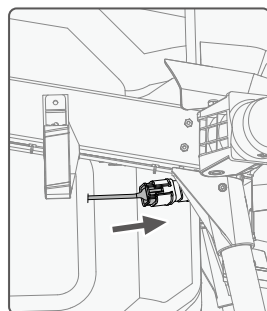

## Specifications

Items	T40 Spreading System	T20P Spreading System
Compatible Aircraft <sup>[1]</sup>	Agras T40	Agras T20P
Spreading System Weight (inc. spread tank and fender)	4.41 kg	3.57 kg
Spread Tank Volume	70 L	35 L
Spread Tank Internal Load <sup>[2]</sup>	50 kg	25 kg
Compatible Material Diameter	0.5-5 mm	
Spreading Range	Varies according to material diameter, spinner disk rotating speed, hopper outlet size, and flying altitude. For best operating performance, it is recommended to adjust the corresponding variables to achieve a spreading range of 5-7 meters.	

- [1] The aircraft firmware must support the spreading system. Check the release notes of the corresponding aircraft on the official DJI website.
- [2] The DJI Agras app will intelligently recommend the payload weight limit for the spread tank according to the current status and surroundings of the aircraft. Do not exceed the recommended payload weight limit when adding material to the spread tank. Otherwise, the flight safety may be affected.

### T40/T20P Drone Recommended Maintenance Cycle

Part for service	Module	Recommended service time	Recommended replacement cycle
Propulsion system - motor	Motor	<ol style="list-style-type: none"> <li>1. Carry out the first inspection for a new drone after 100 flights.</li> <li>2. Carry out an inspection every 100h after the first inspection.</li> <li>3. If an ESC is stalling, and temperature of the motor/ESC is abnormal, carry out this inspection.</li> <li>4. If the motor is damaged due to external force, carry out this inspection.</li> </ol>	Replacement after 1,000h of usage is recommended.
Propulsion system - motor internal resistance	Motor	<ol style="list-style-type: none"> <li>1. Carry out the first inspection for a new drone after 100 flights.</li> <li>2. Carry out an inspection every 100h or 1 month after the first inspection.</li> <li>3. If an ESC is stalling, and temperature of the motor/ESC is abnormal, carry out this inspection.</li> </ol>	Replacement after 1,000h of usage is recommended.
Propulsion system - ESC	ESC	Every 6 months	Replacement after 36 months of usage is recommended.
Propulsion system - motor base	Motor Base	<ol style="list-style-type: none"> <li>1. Carry out the first inspection for a new drone after 100 flights.</li> <li>2. Carry out an inspection every 100h or 1 month after the first inspection.</li> <li>3. If the motor base is damaged due to external force, carry out this inspection.</li> </ol>	Replacement after 500 hours of usage is recommended.
Propulsion system - propellers	Propellers	<ol style="list-style-type: none"> <li>1. Carry out the first inspection for a new drone after 100 flights.</li> <li>2. Carry out an inspection every 100h or 1 month after the first inspection.</li> <li>3. If an ESC is stalling, and temperature of the motor/ESC is abnormal, carry out this inspection.</li> </ol>	Replacement after 700 hours of usage is recommended.
Propulsion system - propeller adapter	Propeller Adapter	Before daily operation preparation	Replacement after 1,000h of usage is recommended.
Propulsion system - screw bolts of frame arm	Screw Bolts of Frame Arm	Every 1 month	Replacement after 1,000h of usage is recommended.
Aircraft components - frame arm connector	Frame Arm Connector	Every 1 month	Replacement after 1,000h of usage is recommended.
Aircraft components - screws	Securing screws of frame arm buckle	Every 1 month	Replacement after 1,000h of usage is recommended.



Aircraft components - connector	Aircraft Connector	Every 1 month	Replacement after 1,000h of usage is recommended.
Middle frame fixing piece - screws	Screw securing the middle frame	Every 1 month	Replacement after 1,000h of usage is recommended.
Landing gear components - screws	Screw Bolts Securing the Landing Gear	Every 1 month	Replacement after 1,000h of usage is recommended.
Landing gear components - fixing bracket	Radar Fixing Bracket	Every 1 month	Replacement after 1,000h of usage is recommended.
Spraying system - delivery pump	Delivery Pump	Every 100h or 1 month	Pump replacement after 500h of usage is recommended. Motor replacement after 1,000h of usage is recommended.
Spraying system - sprinkler	Sprinkler	Every 100h or 1 month	Replacement after 1,000h of usage is recommended.
Spraying system - hose connector	Hose Connector	Before daily operation preparation	Replacement after 1,000h of usage is recommended.
Spraying system - hose	Hose	Before daily operation preparation	Replacement after 1,000h of usage is recommended.
Spraying system - weight sensor	Weight Sensor	Every 100h or 1 month	Replacement after 1,000h of usage is recommended.
Spraying system - filter and liquid level gauge	Liquid Level Gauge	Before daily operation preparation	Replacement after 1,000h of usage is recommended.
Spraying system - spray tank	Spraying System	Every 6 months	Replacement after 1,000h of usage is recommended.
RF module	RF Module	Every 6 months	Replacement after 36 months of usage is recommended.
Aerial-electronics system module	Aerial-Electronics System Module	Every 6 months	Replacement after 36 months of usage is recommended.
Cable distribution board module	Cable Distribution Board Module	Every 6 months	Replacement after 36 months of usage is recommended.
Spraying module	Spraying Module	Every 6 months	Replacement after 36 months of usage is recommended.
Radar system - omnidirectional digital radar	Omnidirectional Digital Radar	Every 6 months	Replacement after 36 months of usage is recommended.

Radar system - backward and downward radar	Backward and Downward Radar	Every 6 months	Replacement after 36 months of usage is recommended.
Power distribution module	Power Distribution Module	Every 6 months	Replacement after 36 months of usage is recommended.
Aircraft components - front frame	Front Frame	Every 6 months	Replacement after 1,000h of usage is recommended.
Aircraft components - rear frame	Rear Frame	Every 6 months	Replacement after 1,000h of usage is recommended.
Aircraft components - middle frame	Middle Frame	Every 6 months	Replacement after 1,000h of usage is recommended.
Positioning system - SDR antenna	SDR Antenna	Every 6 months	Replacement after 36 months of usage is recommended.
Positioning system - RTK module	RTK Module	Every 6 months	Replacement after 36 months of usage is recommended.
Aircraft cables	Aircraft Cable	Every 1 month	Replacement after 36 months of usage is recommended.
Spraying system - flow meter	Flow Meter	Every 1 month	Replacement after 36 months or 3,000h of usage is recommended.
Aircraft components - battery slider	Battery Slider	Replacement after 2,000 times of plugging and unplugging is required or 1 month	Replacement after 1,000h of usage is recommended.
Remote controller	Remote controller	Every 1 month	Replacement after 36 months of usage is recommended.
Battery	Aircraft Standard Battery	After 100 cycles of charging or 1 month	Replacement after 1,000h of usage is recommended.
Intelligent Charger	Intelligent Charger	After 200 cycles of charging or 1 month	Replacement after 1,000h of usage is recommended.

## FAR Remote ID Compliance Information

The aircraft complies with the requirements of 14 CFR Part 89:

- The aircraft automatically initiates a pre-flight self-test (PFST) of the Remote ID system before takeoff and cannot take off if it does not pass the PFST<sup>[1]</sup>. The results of the PFST of the Remote ID system can be viewed in a DJI flight control app such as DJI Agras.
- The aircraft monitors the Remote ID system functionality from pre-flight to shut down. If the Remote ID system malfunctions or has a failure, an alarm will be displayed in a DJI flight control app such as DJI Agras.
- The user shall keep the DJI flight app running in the foreground and always allow it to obtain the location information of the remote controller.

### Footnotes

- [1] The pass criterion for PFST is that the hardware and software of the Remote ID required-data source and transmitter radio in the Remote ID system are functioning properly.

DJI Support

<http://www.dji.com/support>

This content is subject to change without prior notice.

DJI and AGRAS are trademarks of DJI.

Copyright © 2023 DJI All Rights Reserved.