

DJI AVATA 2

User Manual

v1.0 2024.04

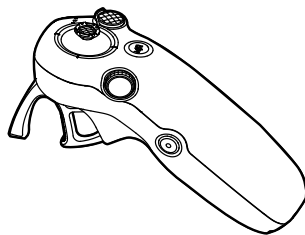

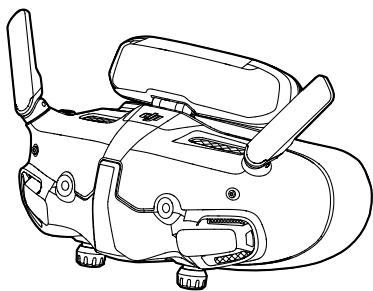
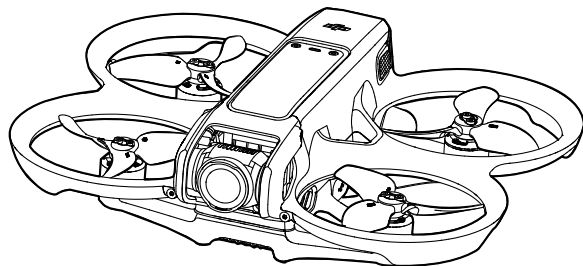

This document is copyrighted by DJI with all rights reserved. Unless otherwise authorized by DJI, you are not eligible to use or allow others to use the document or any part of the document by reproducing, transferring, or selling the document. Users should only refer to this document and the content thereof as instructions to operate DJI UAV. The document should not be used for other purposes.

Searching for Keywords

Search for keywords such as “battery” and “install” to find a topic. If you are using Adobe Acrobat Reader to read this document, press Ctrl+F on Windows or Command+F on Mac to begin a search.

Navigating to a Topic

View a complete list of topics in the table of contents. Click on a topic to navigate to that section.

Printing this Document

This document supports high resolution printing.

Using the Manual

Legend

 Important

 Hints and Tips

 Reference

Read Before the First Flight

Read the following documents before using DJI AVATA™ 2.

1. Safety Guidelines
2. Quick Start Guide
3. User Manual

It is recommended to watch all tutorial videos and read the safety guidelines before using for the first time. Prepare for your first flight by reviewing the quick start guide and refer to this user manual for more information.

Video Tutorials

Go to the address below or scan the QR code to watch the tutorial videos, which demonstrate how to use the product safely:



<https://www.dji.com/avata-2/video>

Download the DJI Fly App

Make sure to use DJI Fly during flight. Scan the QR code to download the latest version.



-  • The Android version of DJI Fly is compatible with Android v7.0 and later. The iOS version of DJI Fly is compatible with iOS v11.0 and later.
- The interface and functions of DJI Fly may vary as the software version is updated. Actual usage experience is based on the software version used.

* For increased safety, flight is restricted to a height of 98.4 ft (30 m) and a range of 164 ft (50 m) when not connected or logged into the app during flight. This applies to DJI Fly and all apps compatible with DJI aircraft.

Download DJI Assistant 2

Download DJI ASSISTANT™ 2 (Consumer Drones Series) at:

<https://www.dji.com/downloads/softwares/dji-assistant-2-consumer-drones-series>



- The operating temperature of this product is -10° to 40° C. It does not meet the standard operating temperature for military-grade application (-55° to 125° C), which is required to endure greater environmental variability. Operate the product appropriately and only for applications that meet the operating temperature range requirements of that grade.
-

Contents

Using the Manual	3
Legend	3
Read Before the First Flight	3
Video Tutorials	3
Download the DJI Fly App	3
Download DJI Assistant 2	4
Product Profile	10
Introduction	10
Using for the First Time	11
Preparing the Aircraft	11
Preparing DJI Goggles 3	13
Preparing DJI RC Motion 3	19
Linking	20
Activation	21
Updating Firmware	22
Overview	23
Aircraft	23
DJI Goggles 3	23
DJI RC Motion 3	24
Flight Safety	26
Flight Restrictions	26
GEO (Geospatial Environment Online) System	26
Flight Limits	26
Unlocking GEO Zones	28
Flight Environment Requirements	29
Operating the Aircraft Responsibly	30
Pre-Flight Checklist	30
Flight Operation	33
Basic Flight Operations	33
Taking Off, Braking and Landing	34
Flying Forward and Backward	35
Adjusting Aircraft Orientation	36
Making the Aircraft Ascend or Descend at an Angle	36
Controlling the Gimbal and Camera	37

Switching Flight Modes	37
Head Tracking	37
Easy ACRO	38
Slide	39
180° Drift	39
Flip	40
Video Recording Suggestions and Tips	40
Aircraft	42
Flight Modes	42
Aircraft Status Indicator	43
Return to Home	44
Warnings	44
Trigger Method	44
RTH Procedure	45
Landing Protection	45
Vision System and Infrared Sensing System	46
Detection Range	47
Propellers	48
Attaching and Detaching the Propellers	49
Intelligent Flight Battery	51
Warnings	51
Using the Battery	52
Inserting/Removing the Battery	52
Charging the Battery	54
Gimbal and Camera	58
Gimbal Profile	58
Warnings	59
Footage Storage and Export	59
Footage Storage	59
Footage Export	60
QuickTransfer	60
DJI Goggles 3	63
Operating the Goggles	63
Buttons	63
AR Cursor	64
Goggles Screen	67

FPV View	67
Shortcut Menu	68
Camera Settings	69
Goggles Menu	70
Goggles Footage Storage and Export	73
Footage Storage	73
Footage Export	73
Formatting the SD Card	73
Real View	74
Real View PiP	74
Liveview Sharing	74
Wired Connection with Mobile Device	75
Wireless Connection with Mobile Device	75
Broadcasting to Other Goggles	75
Panorama/3D Video Playback	76
DJI Motion Controller	78
Operation	78
Powering On/Off	78
Charging the Battery	78
Button Features	79
Optimal Transmission Zone	80
Motion Controller Alert	81
Motion Controller Calibration	81
DJI Fly App	83
Appendix	85
Specifications	85
DJI Avata 2	85
DJI Goggles 3	90
DJI RC Motion 3	93
Compatible Products	93
Updating Firmware	94
Using DJI Fly	94
Using DJI Assistant 2 (Consumer Drones Series)	94
Maintenance Instructions	95
Troubleshooting Procedures	96
Risk and Warnings	96

DJI Avata 2	96
DJI Goggles 3	96
Disposal	97
Battery Disposal	97
C1 Certification	98
MTOM Statement	98
Direct Remote ID	98
Low Blue Light Statement	98
List of Items, including qualified accessories	99
List of Spare and Replacement Parts	99
GEO Awareness	99
FAR Remote ID Compliance Information	103
Flight Data	104
Aftersales Information	104
Maintenance	105
Replacing the Foam Padding for Goggles	105
Cleaning and Maintenance of the Goggles	106

Product Profile

Product Profile

Introduction

DJI Avata 2 is a compact and portable FPV camera drone equipped with built-in propeller guards. The aircraft uses both GNSS and a Vision System, allowing for stable hovering and smooth aerobatic maneuvers while flying both indoors and out. With a gimbal and 1/1.3" sensor camera, the aircraft shoots stable 4K 60fps ultra-HD video and 4K photos. The maximum flight time of the aircraft is approximately 23 minutes^[1].

When the aircraft is used with the compatible goggles and remote control devices in an unobstructed, interference-free environment, the maximum video transmission range can reach 8 mi (13 km)^[2], with a bitrate up to 60 Mbps, providing an immersive flight experience.

DJI Goggles 3 (hereinafter referred to as goggles) are equipped with two high-performance screens, giving you a real-time FPV experience. To provide a more comfortable experience for users who wear glasses or have visual impairments, the goggles support diopter adjustment so that glasses are not required during use. There are two cameras on the front side of the goggles, so users can view the surrounding environment via Real View without having to take off the goggles. With DJI Goggles 3 and DJI RC Motion 3 (hereinafter referred to as motion controller), users can easily and intuitively control the aircraft, and enjoy a new and convenient flight control experience.



- [1] The maximum flight time of the aircraft is measured at a constant flying speed of 21.6 kph in a windless environment at sea level, with camera parameters set to 1080p/30fps, video mode off, and from 100% battery level until 0%. Data is for reference only. Always pay attention to reminders on the goggle screen during your flight.
- [2] The remote control devices reach their maximum transmission distance (FCC) in a wide open area with no electromagnetic interference at an altitude of about 120 m (400 ft). The maximum transmission distance refers to the maximum distance that the aircraft can still send and receive transmissions. It does not refer to the maximum distance the aircraft can fly in a single flight.

- ☀️ • Visit the official DJI website to check the goggles and remote control devices supported by the aircraft. This manual only takes DJI Goggles 3 and DJI RC Motion 3 as examples for introduction. Refer to the user manuals of other supported devices respectively for use.
- ⚠️ • Using the goggles does not satisfy the requirement of visual line of sight (VLOS). Some countries or regions require a visual observer to assist during flight. Make sure to comply with local regulations when using the goggles.
 - DJI Goggles 3, DJI RC Motion 3, DJI FPV Remote Controller 3, and all types of ND filters are fully compatible with DJI Avata 2.

Using for the First Time



Click the link below or scan the QR code to watch the tutorial video before first time use.



<https://www.dji.com/avata-2/video>

Preparing the Aircraft

All Intelligent Flight Batteries are in hibernation mode before shipment to ensure safety. Charge to activate the batteries before first use. Connect the USB charger to the USB-C port on the aircraft to charge. The battery is activated when it begins charging.

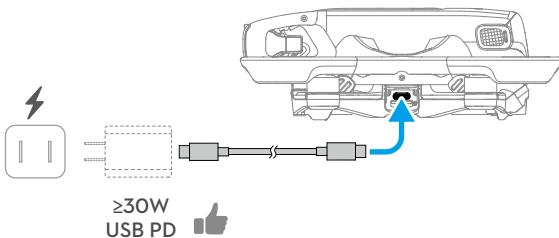

Remove the gimbal protector.

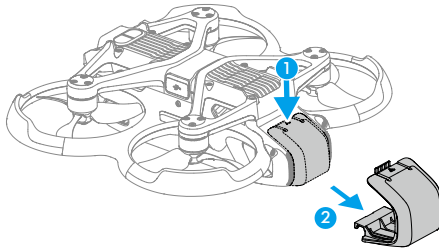

- It is recommended to use the DJI 65W USB-C Charger or other USB Power Delivery chargers with a charging power equal to or greater than 30W.
- It is recommended to attach the gimbal protector to protect the gimbal when the aircraft is not in use. Adjust the camera to keep it facing forward and horizontal, then install the gimbal protector and make sure it is secure.



- Peel off the protective stickers from the gimbal camera before first use.
 - Make sure to remove the gimbal protector before powering on the aircraft. Otherwise, it may affect the aircraft when performing self-diagnostics.
-

Preparing DJI Goggles 3

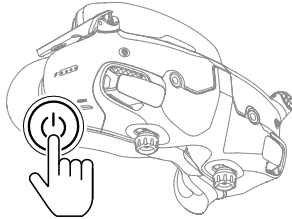

Powering on the Goggles



































Press the power button once to check the current battery level.

Press once, then press and hold for two seconds to power the goggles on or off.

The battery level LEDs display the power level during charging and when in use:

-  LED is on
-  LED is flashing
-  LED is off

LED1	LED2	LED3	LED4	Battery Level
				89%-100%
				76%-88%
				64%-75%
				51%-63%
				39%-50%
				26%-38%
				14%-25%
				1%-13%

If the battery level is low, it is recommended to use a USB charger to charge the device.

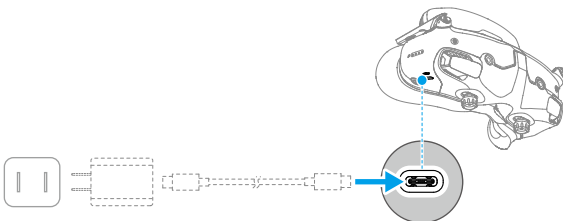

The table below shows the battery level during charging:

LED1	LED2	LED3	LED4	Battery Level
				1%-50%
				51%-75%
				76%-99%
				100%

• USB-C port spec: USB 2.0 (480 Mbps). The maximum input power is 9V/3A.

Wearing the Goggles

- The battery wires are embedded in the headband. DO NOT pull the headband with force to avoid damaging the wires.
- Fold the antennas to avoid damage when the goggles are not in use.
- DO NOT tear or scratch the foam padding, the additional forehead pad, and the soft side of the battery compartment with sharp objects.
- DO NOT bend the additional forehead pad with force.
- DO NOT rotate the headband adjustment knob or the diopter adjustment knob with force to avoid component damage.

1. Unfold the antennas.
2. Adjust the forehead pad downward to the lowest position.

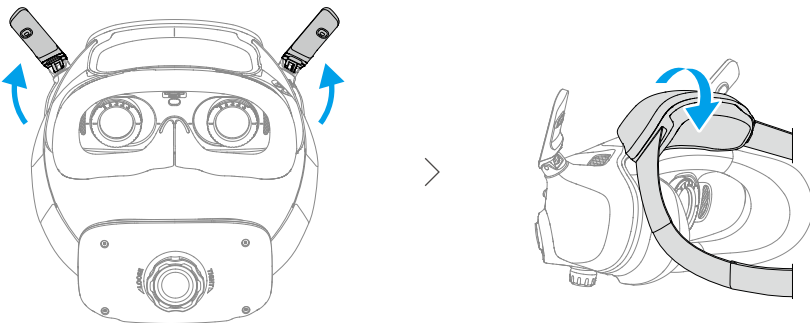

- Put on the goggles after the devices are powered on.
- Rotate the headband adjustment knob on the battery compartment to adjust the length of the headband. Rotate clockwise to tighten the headband and counterclockwise to loosen the headband. It is recommended to wear the goggles with the battery compartment placed on the upper back part of the head to avoid it sliding down.

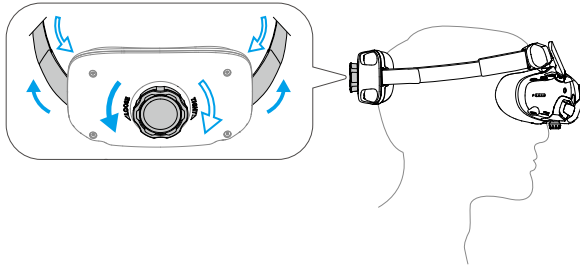

Getting Clear Vision

Rotate the knobs on the bottom of the goggles to adjust the diopters if your vision is in the range of $-6.0D$ to $+2.0D$. The screen in the goggles will display the diopter value when rotating.

- Rotate both the knobs in the direction as shown to unlock them. Once unlocked, the knobs will pop out.

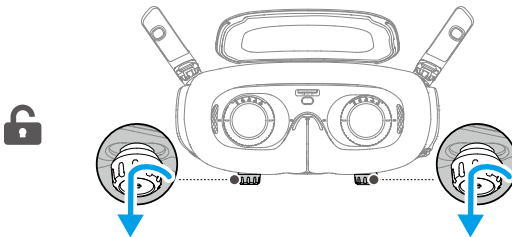

- Slide left and right to adjust the distance between the lenses until the image is properly aligned.

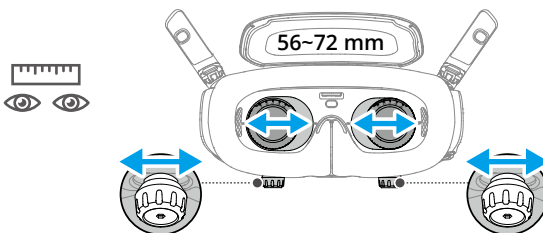

3. Slowly rotate the knobs to adjust the diopters. The supported adjustment range is from -6.0D to +2.0D.

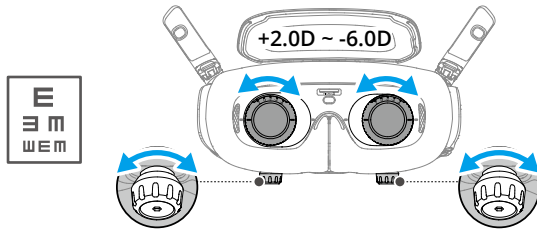

- The goggles do not support astigmatism correction. If you require astigmatism correction or if the diopters of the goggles are unsuitable, you can purchase additional lenses and use the corrective lenses frames provided to install them on the goggles. Refer to “Using the Corrective Lenses” for more information.
- When adjusting the diopters for the first time, you are advised to adjust to a degree that is slightly lower than the strength of your actual eyeglasses. Give your eyes enough time to adapt, then adjust the diopters again until you get a clear view. Do not use a diopter value higher than your actual eyeglass power to avoid eyestrain.

4. After you get a clear view, press the knobs in and rotate them in the direction as shown to lock in the lenses’ position of the lenses and the diopters.

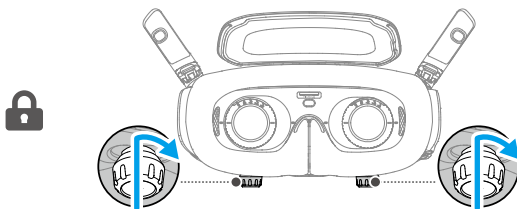

Using the Corrective Lenses

DJI Goggles 3 supports diopter adjustment from -6.0D to +2.0D.

If your vision is in the range of -6.0D to -8.0D, you can install the provided -2.0D Corrective Lenses.

1. Detach the original lens frames from the goggles by rotating counterclockwise as shown.

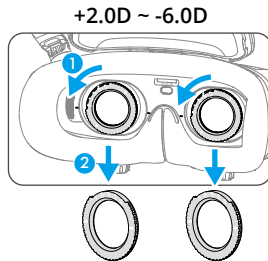

2. Take out the -2.0D Corrective Lenses and peel off the protective film. Distinguish the left and right lenses via the L and R marks on the bottom.
3. Align the positioning marks on the left and right sides of the corrective lens frame with the marks on the inner circle of the goggle lens frame. Mount the corrective lens by pressing it down, and then rotate it clockwise until the marks on the corrective lens frame are aligned with the marks on the goggle lens frame.

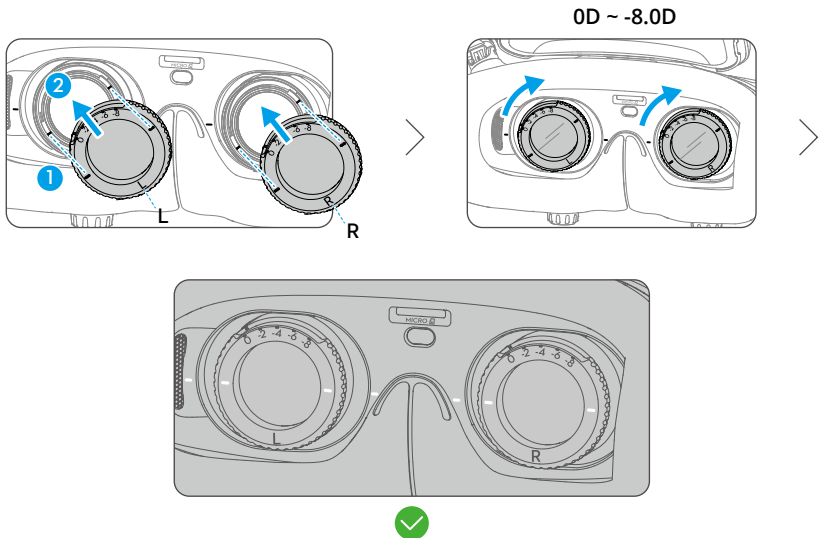

4. Adjust the diopters of the goggles according to your needs and lock the knobs.

⚠ • After installing the -2.0D Corrective Lenses, the diopter value displayed on the screen is not the actual diopter value. The actual diopter value is the sum of the on-screen value and -2.0D.

Purchasing and Installing Your Own Corrective Lenses

If you require astigmatism correction or the diopters of the goggles cannot meet your needs, you can purchase suitable lenses and use the corrective lens frames to install them.

- ⚠ • When purchasing lenses, bring the full set of -2.0D Corrective Lenses (a pair with the frames) to a professional optician to ensure that the shape, size, astigmatism axis, and edge thickness (< 1.8 mm) of the lenses meet the installation requirements of the corrective lens frames.

1. Push and remove the -2.0D lens from the frame. Turn the frame over.

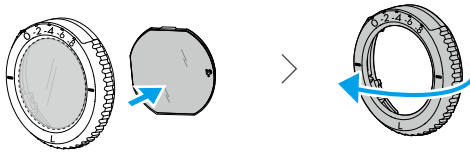

2. Identify the shortest cut edge (c) in the frame.

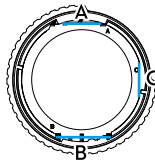

3. Take out the purchased lenses, also identify the shortest cut edge.
4. Distinguish the left and right lens and the corresponding frame. Align the shortest cut edge and install the lens into the frame with the concave side of the lens facing the eye.

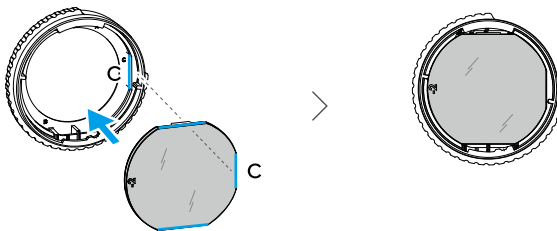

5. Make sure the lens is installed in the correct way and not tilted. Clean the lens with the lens cleaning cloth to wipe off fingerprints and dust.
6. Mount the corrective lenses to the goggles.

7. Adjust the diopters of the goggles according to your needs and lock the knobs.

- 💡 • If you usually wear -9.0D glasses, you can purchase a pair of -3.0D lenses, and adjust the diopters of the goggles to -6.0D. Then the overall diopter value will be -9.0D after the self-prepared lenses are installed.

Using the Additional Forehead Pad

After installing the corrective lenses, the distance between the lenses and your eyes is reduced and your eyelashes might sweep the lenses. If you feel any discomfort, install the additional forehead pad.



1. Peel off the original forehead pad.
2. Attach the additional forehead pad and then install the original forehead pad on top.

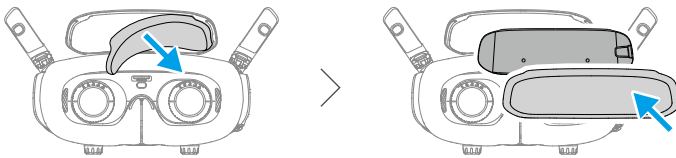

Preparing DJI RC Motion 3

Press the power button once to check the current battery level. Charge before using if the battery level is too low.

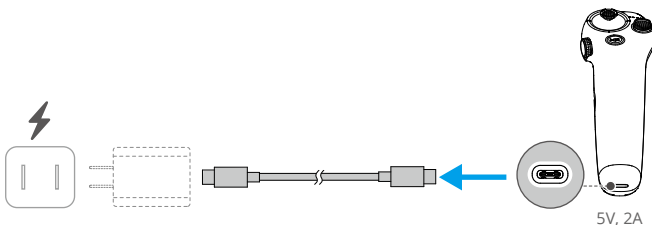

Linking

The aircraft, goggles, and motion controller are already linked when purchased together as a combo. Otherwise, follow the steps below to link the devices.

Make sure that the devices used with the aircraft have been updated to the latest firmware version via the DJI ASSISTANT™ 2 (Consumer Drone Series) software before linking and powered on.

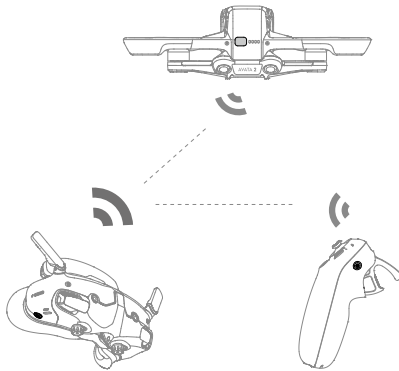

1. Linking the aircraft and the goggles:



- a. Press and hold the power button on the aircraft until it beeps once and the battery level LEDs start to blink in sequence.
- b. Press and hold the power button on the goggles until the goggles start to beep continuously and the battery level LEDs start to blink in sequence.
- c. Once linking is completed, the battery level LEDs of the aircraft turn solid and display the battery level, the goggles stop beeping, and image transmission can be displayed normally.

2. Linking the goggles and motion controller:



- Press and hold the power button on the goggles until the goggles start to beep continuously and the battery level LEDs start to blink in sequence.
- Press and hold the power button on the motion controller until it starts to beep continuously and the battery level LEDs start to blink in sequence.
- Once linking is successful, the goggles and the motion controller stop beeping and both the battery level LEDs turn solid and display the battery level.



- Make sure the devices are within 0.5 m of each other during linking.
- Restart the devices if the devices fail to link. Connect the goggles to a mobile device, run the DJI Fly app, select Connection Guide, and then follow the on-screen instructions to link.



- The aircraft can be controlled with only one remote control device during flight. If your aircraft has been linked with multiple remote control devices, turn off the other remote control devices before flight.

Activation

DJI Avata 2 must be activated before using for the first time. Make sure all devices are linked after powering on the aircraft, goggles, and remote control device. Connect the USB-C port of the goggles to the mobile device, run DJI Fly, and follow the prompts to activate. An internet connection is required for activation. If automatic binding fails, follow the on-screen prompts on DJI Fly to bind the aircraft and goggles. The aircraft and goggles must be bound to receive service under warranty.

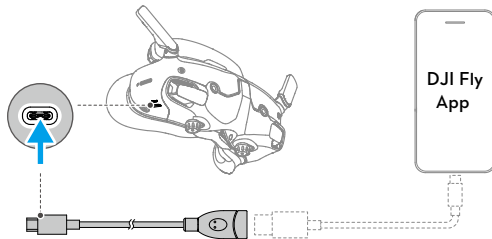

- The goggles only support standard USB-C protocols and MFi-certified Lightning cables. Non-standard cables are not supported. If the devices do not respond after connecting, use a different data cable and try again.

Updating Firmware

A prompt will appear in DJI Fly when new firmware is available. Update the firmware whenever prompted to ensure optimal user experience. Refer to “Updating Firmware” for more information.

Overview

Aircraft

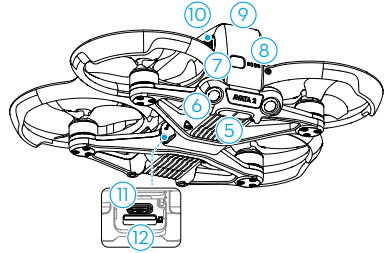
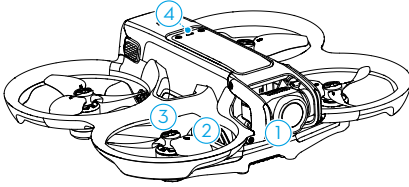

1. Gimbal and Camera
2. Propellers
3. Motors
4. Aircraft Status Indicator
5. Infrared Sensing System
6. Downward and Backward Vision System
7. Power Button
8. Battery Level LEDs
9. Intelligent Flight Battery
10. Battery Buckle
11. USB-C Port
12. microSD Card Slot

DJI Goggles 3

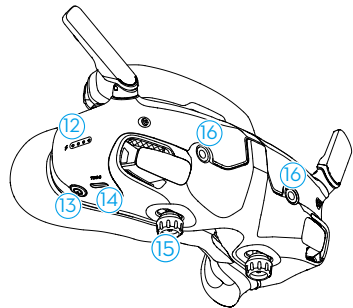
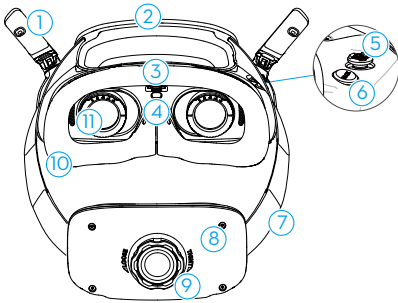

1. Antennas
2. Forehead Pad
3. microSD Card Slot
4. Proximity Sensor
Detects whether the user is wearing the goggles and automatically turns the screen on or off.
5. 5D Button
6. Back Button
7. Headband
8. Battery Compartment
9. Headband Adjustment Knob
10. Foam Padding
11. Lens
12. Battery Level LEDs
13. Power Button/Link Button
14. USB-C Ports
15. IPD (Interpupillary Distance) Slider / Diopter Adjustment Knob (hereinafter referred to as "knob")
16. Camera

DJI RC Motion 3

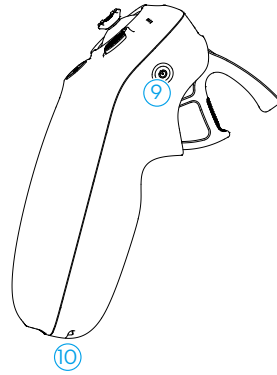
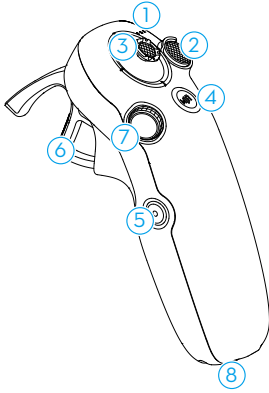

- | | |
|--------------------------|------------------|
| 1. Battery Level LEDs | 6. Accelerator |
| 2. Lock Button | 7. Dial |
| 3. Joystick | 8. USB-C Port |
| 4. Mode Button | 9. Power Button |
| 5. Shutter/Record Button | 10. Lanyard Hole |

Flight Safety

Flight Safety

After completing pre-flight preparations, it is recommended to train your flying skills and practice flying safely. Pick a suitable area to fly in according to the following flight requirements and restrictions. Strictly abide by local laws and regulations when flying. Read the Safety Guidelines before flight to ensure safe use of the product.

Flight Restrictions

GEO (Geospatial Environment Online) System

The DJI Geospatial Environment Online (GEO) System is a global information system that provides real-time information on flight safety and restriction updates and prevents UAVs from flying in restricted airspace. Under exceptional circumstances, restricted areas can be unlocked to allow flights in. Prior to that, the user must submit an unlocking request based on the current restriction level in the intended flight area. The GEO system may not fully comply with local laws and regulations. Users shall be responsible for their own flight safety and must consult with the local authorities on the relevant legal and regulatory requirements before requesting to unlock a flight in a restricted area. For more information about the GEO system, visit <https://fly-safe.dji.com>.

Flight Limits

For safety reasons, flight limits are enabled by default to help users operate this aircraft safely. Users can set flight limits on height and distance. Altitude limits, distance limits, and GEO zones function concurrently to manage flight safety when GNSS is available. Only altitude can be limited when GNSS is unavailable.

Flight Altitude and Distance Limits

Max altitude restricts the flight altitude of the aircraft, while max distance restricts the flight radius around the Home Point. These limits can be set using the goggles for improved flight safety.

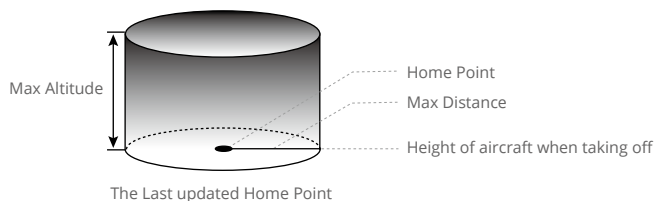

Strong GNSS Signal

	Flight Restrictions	Prompt in Goggles
Max Altitude	Flight altitude must be below the preset height.	Max flight altitude reached.
Max Distance	The straight-line distance from the aircraft to the Home Point cannot exceed the max flight distance set in the goggles.	Max flight distance reached.

Weak GNSS Signal

	Flight Restrictions	Prompt in Goggles
Max Altitude	<ul style="list-style-type: none"> Altitude is restricted to 50 m from the takeoff point if lighting is sufficient. Altitude is restricted to 3 m above the ground if lighting is not sufficient and the infrared sensing system is operating. The altitude is restricted to 50 m from the takeoff point if lighting is not sufficient and the infrared sensing system is not operating. 	Max flight altitude reached.
Max Distance	No limits	

-  Each time the aircraft is powered on, the altitude limit of 3 m or 50 m will be automatically removed as long as the GNSS signal ever becomes strong (GNSS signal display white or yellow) once, and the limit will not take effect even if the GNSS signal becomes weak afterwards.
- If the aircraft flies out of the set flight range due to inertia, users can still control the aircraft but cannot fly it any further. If the aircraft flies above the altitude limit, it will descend below the altitude limit at 5 m/s. If the aircraft flies into an Altitude Zone, landing will be triggered after a 100-second countdown.
 - For safety reasons, DO NOT fly the aircraft close to airports, highways, railway stations, railway lines, city centers, or other sensitive areas. Only fly the aircraft within a visual line of sight.

GEO Zones

The DJI GEO system designates safe flight locations, provides risk levels and safety notices for individual flights and offers information on restricted airspace. All restricted flight areas are referred to as GEO Zones, which are further divided into Restricted Zones, Authorization Zones, Warning Zones, Enhanced Warning Zones, and Altitude Zones. Users can view such information in real-time in DJI Fly. GEO Zones are specific flight areas, including but not limited to airports, large event venues, locations where public emergencies have occurred (such as forest fires), nuclear power plants, prisons, government properties, and military facilities. By default, the GEO system limits takeoffs and flights in zones that may cause safety or security concerns. A GEO Zone map that contains comprehensive information on GEO Zones around the globe is available on the official DJI website: <https://fly-safe.dji.com/nfz/nfz-query>.

Unlocking GEO Zones

To satisfy the needs of different users, DJI provides two unlocking modes: Self-Unlocking and Custom Unlocking. Users may make a request on the DJI Fly Safe website.

Self-Unlocking is intended for unlocking Authorization Zones. To complete Self-Unlocking, the user must submit an unlocking request via the DJI Fly Safe website at <https://fly-safe.dji.com>. Once the unlocking request is approved, the user may synchronize the unlocking license through the DJI Fly app. Alternatively, to unlock a zone, the user may launch or fly the aircraft directly into the approved Authorization Zone and follow the prompts in DJI Fly to unlock the zone.

Custom Unlocking is tailored for users with special requirements. It designates user-defined custom flight areas and provides flight permission documents specific to the needs of different users. This unlocking option is available in all countries and regions and can be requested via the DJI Fly Safe website at <https://www.dji.com/flysafe>.



- To ensure flight safety, the aircraft will not be able to fly out of the unlocked zone after entering it. If the Home Point is outside the unlocked zone, the aircraft will not be able to return home.
-

Flight Environment Requirements

1. DO NOT operate the aircraft in severe weather conditions including wind speeds exceeding 10.7 m/s, snow, thunder and lightning, rain, and fog.
2. Only fly in open areas. Tall buildings and large metal structures may affect the accuracy of the onboard compass and GNSS system. Therefore, DO NOT take off from a balcony or anywhere within 15 m of buildings. Keep a distance of at least 15 m from buildings during flight. After takeoff, make sure you are notified with the message prompt "Home Point has been updated" before continuing flight. If the aircraft has taken off near buildings, the accuracy of the Home Point cannot be guaranteed. In this case, pay close attention to the current position of the aircraft during auto RTH. When the aircraft is close to the Home Point, it is recommended to cancel auto RTH and manually control the aircraft to land at an appropriate location.
3. When the GNSS signal is weak, fly the aircraft in environments with good lighting and visibility. The vision system may not work properly in poor light conditions. Only fly the aircraft in the daytime.
4. Avoid obstacles, crowds, trees, and bodies of water (recommended height is at least 6 m above water).
5. Minimize interference by avoiding areas with high levels of electromagnetism, such as locations near power lines, base stations, electrical substations, and broadcasting towers.
6. Try to keep a distance of more than 200 m from strong electromagnetic wave interference sites, such as radar stations, microwave relay stations, mobile communication base stations, and drone jamming equipment.
7. The performance of the aircraft and its battery is limited when flying at altitudes above 5000 m (16,404 ft). Fly with caution.
8. The braking distance of the aircraft is affected by the flight altitude. The higher the altitude, the greater the braking distance. When flying at an altitude above 3000 m (9843 ft), the user should reserve at least 20 m for vertical braking distance and 25 m for horizontal braking distance to ensure flight safety.
9. GNSS cannot be used on the aircraft in polar regions. Use the vision system instead.
10. DO NOT take off from moving objects, such as cars and ships.
11. DO NOT take off from solid-colored surfaces or surfaces with strong reflections such as a car roof.
12. DO NOT operate the aircraft in an environment where there is risk of a fire or explosion.
13. Operate the aircraft, goggles, remote control device, battery, battery charger, and the battery charging hub in a dry environment.
14. DO NOT use the aircraft, goggles, remote control device, battery, battery charger, and the battery charging hub near accidents, fire, explosions, floods, tsunamis, avalanches, landslides, earthquakes, dust, sandstorms, salt spray, or fungus.
15. DO NOT operate the aircraft near bird flocks.
16. DO NOT use the battery charger in humid environments.

Operating the Aircraft Responsibly

To avoid serious injury and property damage, observe the following rules:

1. Make sure you are NOT under the influence of anesthesia, alcohol, or drugs or suffering from dizziness, fatigue, nausea, or other conditions that could impair the ability to operate the aircraft safely.
2. When landing, power off the aircraft first, then power off the remote control device.
3. DO NOT drop, launch, fire, or otherwise project any dangerous payloads on or at any buildings, persons, or animals, which could cause personal injury or property damage.
4. DO NOT use an aircraft that has been crashed or accidentally damaged or an aircraft that is not in good condition.
5. Make sure to train sufficiently and have contingency plans for emergencies or when an incident occurs.
6. Make sure to have a flight plan. DO NOT fly the aircraft recklessly.
7. Respect the privacy of others when using the camera. Make sure to comply with local privacy laws, regulations, and moral standards.
8. DO NOT use this product for any reason other than general personal use.
9. DO NOT use it for illegal or inappropriate purposes such as spying, military operations, or unauthorized investigations.
10. DO NOT use this product to defame, abuse, harass, stalk, threaten, or otherwise violate legal rights such as the right to privacy and publicity of others.
11. DO NOT trespass onto the private property of others.

Pre-Flight Checklist

1. Make sure the goggles, remote control devices, Intelligent Flight Battery, and mobile device are fully charged.
2. Make sure the propellers are mounted correctly and securely.
3. Make sure the Intelligent Flight Battery is properly connected and secure.
4. Make sure the dust-resistant covers of the USB-C port and the microSD card slot are firmly closed.
5. Make sure the gimbal protector has been removed. Make sure all camera lenses and sensors are clean.
6. Make sure the aircraft, the remote control device, the gimbal and the camera are functioning normally.
7. Make sure the goggles antennas are unfolded.
8. Make sure that the goggles are functioning normally and display the video transmission.
9. Make sure the max flight altitude, max flight distance and RTH altitude are all set properly in the goggles according to the local laws and regulations.
10. Only use genuine DJI parts or DJI-authorized parts. Unauthorized parts may cause system malfunctions and compromise flight safety.

11. Check if the Remote ID is up to date and working.
12. DO NOT fly over densely populated areas.

Flight Operation

Flight Operation

This section explains how to perform different actions with the aircraft. The steps below will help users operate the aircraft properly.

1. Place the aircraft in an open, flat area with the rear of the aircraft facing the user.
2. Power on the goggles, remote control device, and the aircraft.
3. Wait until the aircraft status indicator blinks green slowly and put on the goggles.
4. Start the motors.
5. Check the flight liveview in the goggles to make sure that there are no warning prompts and that the GNSS signal is strong.
6. Press the lock button twice to start the aircraft motors, then press and hold to make the aircraft take off. The aircraft will ascend to approximately 1.2 m and hover.
7. Press and hold the lock button while the aircraft is hovering to land it automatically and stop the motors.
8. Power off the aircraft, goggles, and remote control device.

Basic Flight Operations



- It is recommended to watch the tutorial guide in the goggles before the first flight. Go to Settings > Control > Motion Controller > Flight Control > Motion Controller Instructions.

Operate the aircraft by using the lock button, joystick, and accelerator of the DJI Motion Controller 3.

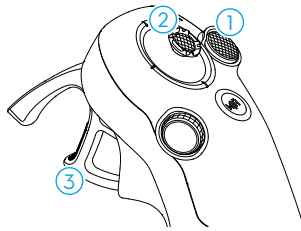

- ① Use the lock button to control the takeoff, landing, and braking of the aircraft.
- ② Move the joystick to make the aircraft ascend, descend, or move left or right horizontally*.
- ③ There are two levels of pressure when pressing the accelerator. When gently pressing to the position in the middle of the first and second stop, you can feel a noticeable pause. Press the accelerator to different stops to control different actions of the aircraft.

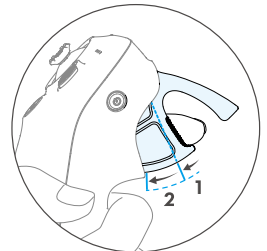

* When Easy ACRO is not enabled or the Easy ACRO action is selected as Slide.

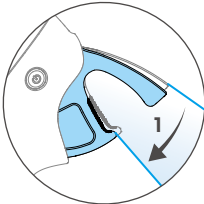
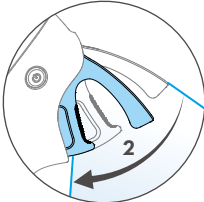
	<p>When the accelerator is not pressed, the aircraft will hover.</p>
	<p>When gently pressing the accelerator to the first stop, you can adjust the aircraft orientation by tilting the motion controller vertically to the left or right. Note that the aircraft will not fly forward at this time.</p>
	<p>Press the accelerator to the second stop to make the aircraft to fly in the direction of the circle in the goggles.</p>

Taking Off, Braking and Landing

Takeoff	Press the lock button twice to start the aircraft motors, then press and hold the button again to make the aircraft take off. The aircraft will ascend to approximately 1.2 m and hover.
Braking	Press the lock button during flight to make the aircraft brake and hover in place. Press again to resume flight control.
Landing	Press and hold the lock button while the aircraft is hovering to land it automatically and stop the motors.



- After the aircraft motors have been started by double-pressing the lock button, slowly push the joystick up to make the aircraft take off.
- When Easy ACRO is disabled, once the aircraft flies to the landing position, gently push the joystick downwards to land the aircraft. After landing, push the joystick down and hold in position until the motors stop.

- ⚠️ • If an emergency occurs (such as a collision or the aircraft is out of control) during flight, pressing the lock button four times will trigger Stop Motors Mid-flight, which will stop the aircraft motors immediately. **The Stop Motors Mid-flight function will cause the aircraft to crash. Operate with caution.**
- To ensure flight safety when using the motion controller, press the lock button once to brake and hover before operating the goggles. Failure to do so is a safety risk and may lead to the aircraft losing control or injury.

Flying Forward and Backward

Press or push the accelerator of the motion controller to fly forward or backward. Apply more pressure when pressing or pushing to accelerate. Release to stop and hover.

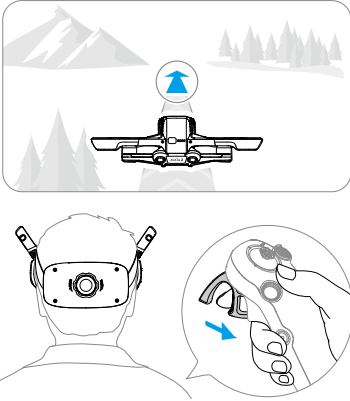
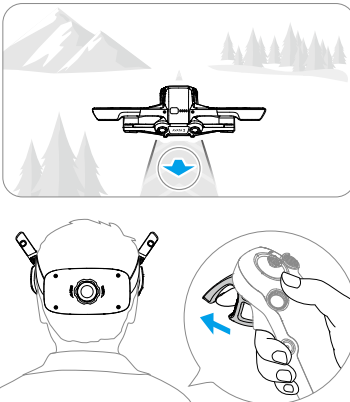
Flight Trajectory	Remarks
 <p>The diagram illustrates forward flight. The top part shows a top-down view of the aircraft with a blue arrow pointing upwards from a circle in the goggles, indicating the direction of flight. The bottom part shows a side view of a hand holding the motion controller with a blue arrow pointing forward from the accelerator, indicating the input required for forward flight.</p>	<p>Press the accelerator to the second stop to make the aircraft fly in the direction of the circle in the goggles.</p>
 <p>The diagram illustrates backward flight. The top part shows a top-down view of the aircraft with a blue arrow pointing downwards from a circle in the goggles, indicating the direction of flight. The bottom part shows a side view of a hand holding the motion controller with a blue arrow pointing backward from the accelerator, indicating the input required for backward flight.</p>	<p>Push the accelerator forward to fly the aircraft in reverse.</p>

Adjusting Aircraft Orientation

Gently press the accelerator to the first stop and simultaneously tilt the top of the motion controller in either direction to make the aircraft rotate. The greater the tilt angle of the motion controller, the faster the aircraft will rotate. The circle in the goggles will move left and right and the flight liveview will change accordingly.

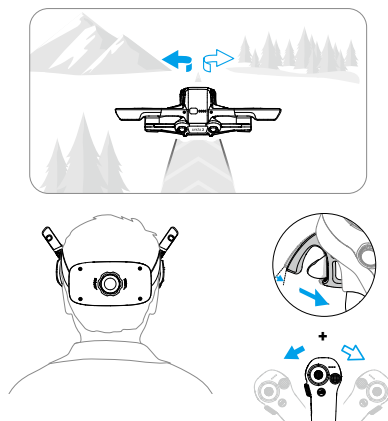

Making the Aircraft Ascend or Descend at an Angle

When the aircraft needs to fly at an upward angle, press the accelerator to the second stop while simultaneously tilting the motion controller up.

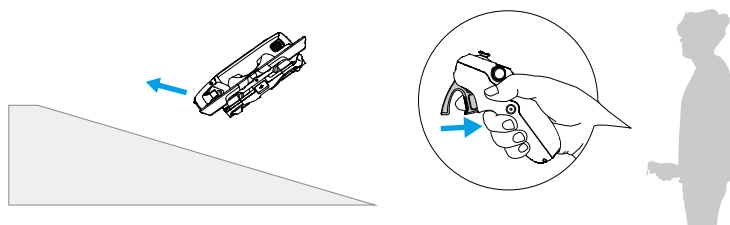

When the aircraft needs to fly at a downward angle, press the accelerator to the second stop while simultaneously tilting the motion controller down.

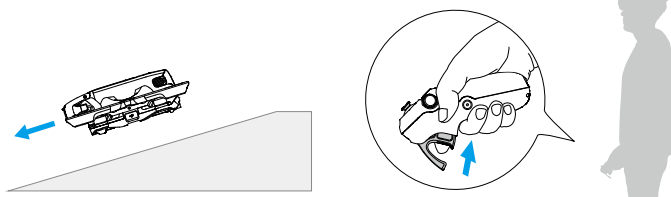

Controlling the Gimbal and Camera

Tilt the motion controller up and down to control the tilt of the gimbal. The tilt of the gimbal changes with the tilt of the motion controller accordingly and is always consistent with the orientation of the motion controller. The circle in the goggles will move up and down and the flight liveview will change accordingly.

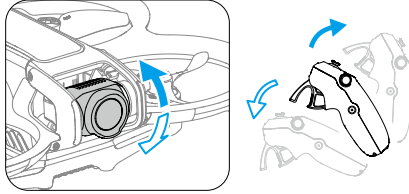

Switching Flight Modes

The motion controller has two modes: Normal mode and Sport mode. Normal mode is selected by default.

Press the mode button once to switch between Normal mode and Sport mode. While flying in Sport mode, the flight speed of the aircraft will be faster. The operation logic of the motion controller remains the same in Sport mode as it is in Normal mode.

Refer to the section "Flight Modes" to know more about the difference between each flight mode.



Head Tracking

When Head Tracking is enabled, the horizontal orientation of the aircraft and the gimbal tilt can be controlled through head movements. Open the shortcut menu from the flight liveview, access the quick control menu, and click  to enable Head Tracking.

Once in Head Tracking mode, the motion controller will not be able to control the gimbal tilt, and only control via the aircraft is available. Users can still control the aircraft's heading by tilting the motion controller without pressing the accelerator.

 • Head Tracking is not available after taking off the goggles.

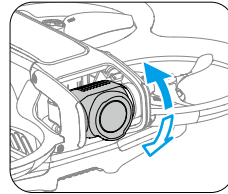
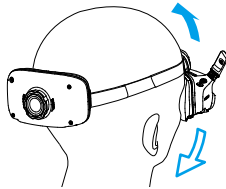
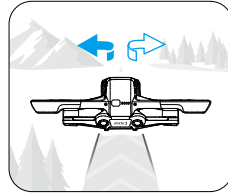
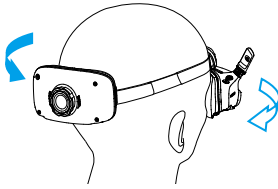

Easy ACRO

Use the motion controller to perform Easy ACRO actions including front flip, backflip, roll, and 180° drift.

 • For flight safety, perform Easy ACRO actions in an open environment.

1. Open the shortcut menu and select Easy ACRO. The aircraft will be in Easy ACRO mode. Easy ACRO includes three actions: Slide, 180° Drift, and Flip. View the selected action on the left side of liveview in the goggles.

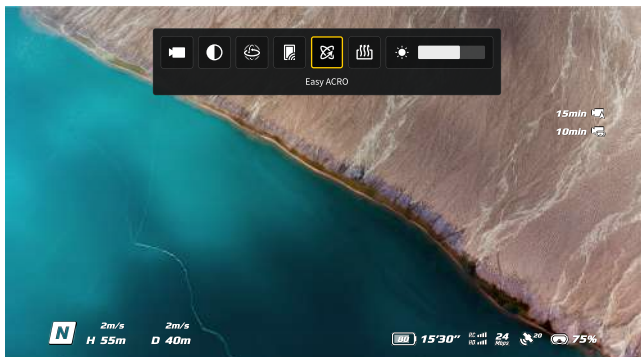

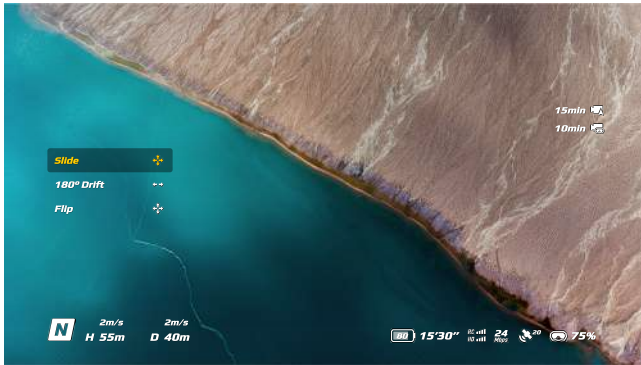

2. Use the dial on the motion controller to switch between Easy ACRO actions.
3. When Easy ACRO is enabled, move the joystick to perform different Easy ACRO actions as shown below.

Slide

Push the joystick up or down to make the aircraft ascend or descend.

Push the joystick left or right to make the aircraft move left or right horizontally.

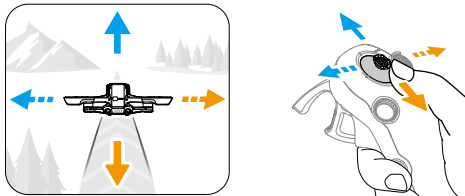

180° Drift

Push the joystick left or right to make the aircraft 180° drift left or right.

The aircraft will not respond when pushing the joystick up or down in this action mode.

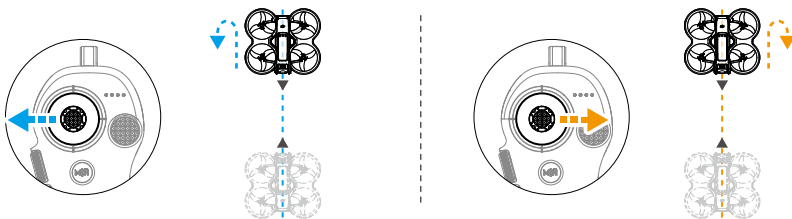

Flip

Push the joystick up or down to make the aircraft perform a front flip or backflip.

Push the joystick left or right to make the aircraft do one roll to the left or right.

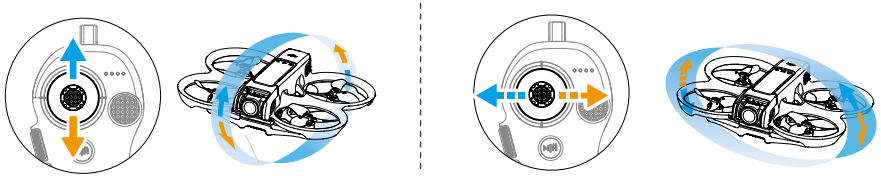

-
- ☀️ • Easy ACRO cannot be enabled in the following situations:
 - a. When recording video;
 - b. When Head Tracking is enabled;
 - c. When used with DJI FPV Remote Controller 3.

-
- ⚠️ • Pay attention to surroundings and make sure there are no obstacles nearby before performing Easy ACRO actions.
 - Easy ACRO is unavailable in the following situations:
 - a. The aircraft is taking off, hovering, landing, or returning to home;
 - b. The aircraft is in Sport mode;
 - c. The aircraft battery level is lower than 25%;
 - d. The altitude of the aircraft is less than 1.5m;
 - e. Flying in an environment with strong wind (wind speed exceeding 10 m/s);
 - f. The positioning performance is not good (the GNSS signal is weak);
 - g. The aircraft is in a buffer zone of a Restricted Zone or an Altitude Zone, or is approaching the Max Flight Distance.
 - As the attitude angle of the aircraft increases (such as when making high-speed turns or when accelerating or decelerating quickly), the aircraft altitude will also need to be increased, otherwise Easy ACRO cannot be used.
-

Video Recording Suggestions and Tips

1. The pre-flight checklist is designed to help the user fly and shoot videos safely. Go through the full pre-flight checklist before each flight.
2. It is recommended to use Normal mode to take photos or record videos.
3. DO NOT fly in bad weather such as on rainy or windy days.
4. Choose the camera settings that best suit your needs.
5. Perform flight tests to establish flight routes and preview scenes.
6. When flying, control the pressure applied on the accelerator to ensure smooth and stable movement of the aircraft.

Aircraft

Aircraft

Flight Modes

The aircraft supports the following flight modes. Flight modes can be switched between Normal mode and Sport mode using the Mode button on the motion controller.

Normal Mode: The aircraft can hover precisely and fly with stability in this mode, making it suitable for most flight scenarios.

Sport Mode: The maximum horizontal flight speed of the aircraft will increase in Sport mode.

Manual Mode: Classic FPV aircraft control mode with the highest maneuverability. In Manual mode, all flight assistance functions including precise hovering and auto-brake are disabled and proficient control skills are required.

In Normal or Sport mode, the aircraft will experience horizontal drift and RTH will be unavailable when the downward vision system is unavailable or disabled and when the GNSS signal is weak or the compass experiences interference. In this case, the aircraft cannot hover or brake automatically. Land the aircraft as soon as possible in order to avoid accidents. Avoid flying in confined spaces, or in areas where the GNSS signal is weak or the lighting is not sufficient.



- For safety reasons, the aircraft flies in Beginner mode by default for the first flight. In Beginner mode, the maximum flight speed of the aircraft is 1 m/s. To exit Beginner mode, open the menu on the goggles, go to Settings > Control > Beginner Mode.
- Manual mode is only supported when using the DJI FPV Remote Controller 3 to operate the aircraft. Throttle stick resistance can also be adjusted. DJI Motion Controller 3 does not support Manual mode. Refer to the DJI FPV Remote Controller 3 User Manual for more information on Manual mode.



- A minimum braking distance of 10 m is required in windless conditions while the aircraft is ascending and descending in Sport mode or Normal mode.
 - The maximum flight speed and braking distance of the aircraft significantly increases in Sport mode. A minimum braking distance of 30 m is required in windless conditions.
 - The responsiveness of the aircraft significantly increases in Sport mode, which means a small control stick movement on the remote control device translates into the aircraft moving a large distance. Make sure to maintain adequate maneuvering space during flight.
-

- When the flight altitude of the aircraft is less than 5 m or when there are obstacles within a radius of 5 m around the aircraft, use caution when enabling Manual mode. The attitude may become unstable when turning the aircraft in Manual mode in the situations mentioned below. Operate the aircraft with caution to ensure a stable flight.
 - a. When turning the aircraft at a high speed;
 - b. When the flight height is over 3000 meters above the sea level;
 - c. When the flight speed exceeds 13 m/s or the wind speed exceeds 7.9 m/s.



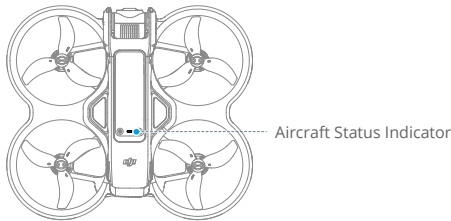

Aircraft Status Indicator

The aircraft has an aircraft status indicator on the top of the body.









Aircraft Status Indicator Descriptions

Normal States

	Blinks red, yellow, and green alternately	Powering on and performing self-diagnostic tests
	Blinks green slowly	GNSS or vision system enabled for positioning
	Blinks yellow slowly	GNSS and vision system disabled
	Blinks purple slowly	The aircraft is in Manual mode



Warning States

	Blinks yellow quickly	Remote control device signal lost
	Blinks red slowly	Takeoff is disabled, e.g. low battery ^[1]
	Blinks red quickly	Critically low battery
	Blinks red	IMU error
	Solid red	Critical error
	Blinks red and yellow alternately	Compass calibration required

[1] If the aircraft cannot takeoff while the status indicators are blinking red slowly, view the warning prompt in the goggles.

Return to Home

The Return to Home (RTH) function will automatically fly the aircraft back to the last recorded Home Point. RTH can be triggered in three ways: the user actively triggers RTH, the aircraft has low battery, or the remote control signal or video transmission signal has been lost (Failsafe RTH is triggered). If the aircraft records the Home Point successfully and the positioning system is functioning normally, when the RTH function is triggered, the aircraft will automatically fly back and land at the Home Point.

	GNSS	Description
Home Point	 10	<p>The first location where the aircraft receives a strong to moderately strong GNSS signal (indicated by a white icon) will be recorded as the default Home Point. The Home Point can be updated when taking off as long as the aircraft receives another strong to moderately strong GNSS signal. If the signal is weak, the Home Point will not be updated. The aircraft status indicator blinks green quickly and a prompt appears in the goggles to confirm the Home Point has been updated.</p> <p>During flight an H symbol is displayed in the goggles to indicate the location of the last recorded Home Point of the aircraft.</p>

Warnings

-  • During RTH, obstacles around and above the aircraft cannot be detected or avoided.
- The aircraft cannot return to the Home Point if the GNSS signal is weak or unavailable. If the GNSS signal becomes weak or unavailable after Failsafe RTH is triggered, the aircraft will automatically descend and land.
- Make sure set the RTH altitude before each flight. Go to Settings > Safety on the goggles and set a suitable RTH altitude.
- GEO Zones will affect RTH. The aircraft will hover if it flies into a GEO Zone during RTH.
- The aircraft may not be able to return to the Home Point when the wind speed is too high. Fly with caution.
- When the aircraft is flying in an environment surrounded by obstacles (such as near tall buildings), or when the GNSS signal is weak, the location of the Home Point may be inaccurate, leading to a large error in the horizontal distance between the aircraft and the Home Point displayed on the goggles. Fly with caution.

Trigger Method

The user actively triggers RTH

Press and hold the Mode button on the motion controller to initiate RTH. The aircraft will fly back to the last updated Home Point. When the aircraft is performing RTH, press the lock button

once to cancel RTH. After exiting RTH, users will regain control of the aircraft.

Aircraft low battery

When the battery level is low and only sufficient to fly to the Home Point, a warning prompt will appear in the goggles and RTH will be triggered following the prompt. RTH can be canceled using the remote control devices. If RTH is canceled following a low battery warning, the Intelligent Flight Battery may not have enough power for the aircraft to land safely, which may lead to the aircraft being crashed or lost.

The aircraft will land automatically if the current battery level can only support the aircraft long enough to descend from its current altitude. Auto landing cannot be canceled, but the remote control devices can be used to control the horizontal movement of the aircraft during landing.

Loss of remote control or video transmission signal

When the remote control signal or video transmission signal is lost, the aircraft will automatically initiate Failsafe RTH if the Signal Lost Action is set to RTH.

The aircraft will fly backwards 50 m along its original flight route and then perform the RTH procedure. The aircraft will directly perform the RTH procedure if the signal is restored when flying backward along the original flight route.



- The response of the aircraft when the wireless signal is lost can be modified in the goggles. The aircraft will not perform Failsafe RTH if land or hover has been selected in the settings.
-

RTH Procedure

1. The Home Point is recorded.
2. RTH is triggered.
3. When RTH begins, the RTH procedure varies according to different RTH distances (the horizontal distance between the aircraft and the Home Point):
 - a. The aircraft lands immediately if the RTH distance is less than 5 m.
 - b. If the RTH distance is farther than 5 m but less than 20 m, it flies to the Home Point in a straight line at the current altitude.
 - c. If RTH distance is farther than 20 m, it ascends to the RTH altitude and flies back to the Home Point. The aircraft flies to the Home Point at the current altitude if the RTH altitude is lower than the current altitude.
4. The aircraft begins to land when it reaches the spot above the Home Point.

Landing Protection

Landing Protection activates during RTH and auto landing.

1. During Landing Protection, the aircraft will automatically detect and carefully land on suitable ground.
2. If the ground is determined unsuitable for landing, the aircraft will hover and wait for pilot confirmation.

3. If Landing Protection is not operational, the goggles will display a landing prompt when the aircraft descends to 0.25 m. Press and hold the lock button on the motion controller and the aircraft will land.

- ⚠ • Landing Protection only assists in determining the landing environment. Pay attention to the surrounding environment during landing to ensure safety.
- In the following situations, Landing Protection may be unavailable and the aircraft may land directly on unsuitable ground:
 - a. Flying over monochrome, reflective, or low-light surfaces, a large area of surfaces without clear texture, or surfaces with dynamic texture, such as smooth ceramic tiles, garage ground with insufficient light, and grass blowing in the wind;
 - b. Flying over obstacles without clear texture, such as large rocks, or reflective or monochrome surfaces, such as raised tiles;
 - c. Flying over small or fine obstacles, such as power lines and tree branches;
 - d. Flying over surfaces that are similar to flat ground, such as trimmed and flat shrubs, flat tree tops, and hemispherical ground.
- In the following situations, Landing Protection may be triggered by mistake and a prompt will appear in the goggles that the aircraft is unable to land:
 - a. Flying over surfaces that the vision system may confuse for water, such as wet ground and areas with puddles;
 - b. Flying over flat surfaces, but there are surfaces with clear texture (oblique surfaces or stairs) nearby, such as monochrome car tops and monochrome tables.

Vision System and Infrared Sensing System

The aircraft is equipped with both a Downward and Backward Vision System and Infrared Sensing System.

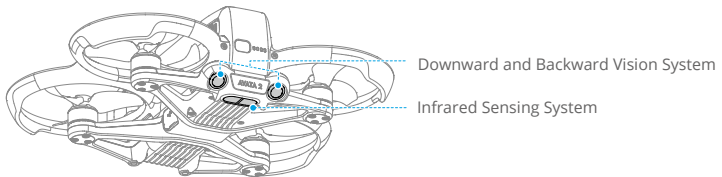

The positioning function of the downward vision system is applicable when GNSS signals are unavailable or weak. It is automatically enabled in Normal or Sport mode.

Detection Range

Backward	FOV: 78° (horizontal), 78° (vertical)
Downward	FOV: 78° (horizontal), 78° (vertical) Precision Measurement Range: 0.3-20 m; Precision Hovering Range: 0.3-10 m.

-  • Pay attention to the flight environment. The vision system and infrared sensing system only work in certain scenarios and cannot replace human control and judgment. During flight, pay attention to the surrounding environment and to the warnings on the goggles. Be responsible for and maintain control of the aircraft at all times.
- The aircraft has a maximum hovering altitude of 20 m when using the vision system in an open and flat environment with clear texture. The vision system works best when the aircraft is at an altitude from 0.5-10 m. Extra caution is required if the altitude of the aircraft is above 10 m as vision positioning performance may be affected.
 - The vision system may not work properly when the aircraft is flying near water. Therefore, the aircraft may not be able to actively avoid water below it when landing. It is recommended to maintain flight control at all times, make reasonable judgments based on the surrounding environment, and avoid over-relying on the downward vision system.
 - The vision system and infrared sensing system may not function properly when the aircraft is flying too fast.
 - The vision system cannot work properly near surfaces without clear pattern variations or where the light is too weak or too strong. The vision system cannot work properly in the following situations:
 - a. Flying near monochrome surfaces (e.g., pure black, pure white, pure green);
 - b. Flying near highly reflective surfaces;
 - c. Flying near water or transparent surfaces;
 - d. Flying near moving surfaces or objects;
 - e. Flying in an area where the lighting changes frequently or drastically;
 - f. Flying near extremely dark (< 10 lux) or bright (> 40,000 lux) surfaces;
 - g. Flying near surfaces that strongly reflect or absorb infrared waves (e.g., mirrors);
 - h. Flying near surfaces without clear patterns or texture (e.g., power poles);
 - i. Flying near surfaces with repeating identical patterns or textures (e.g., tiles with the same design);
 - j. Flying near obstacles with small surface areas (e.g., tree branches and power lines).
 - Keep the sensors clean at all times. DO NOT tamper with the sensors. DO NOT use the aircraft in environments with significant dust or humidity. DO NOT obstruct the infrared sensing system.
 - If the aircraft is involved in a collision, it may be necessary to calibrate the vision system.
 - DO NOT fly when it is rainy, smoggy, or the visibility is lower than 100 m.

- Check the following every time before takeoff:
 - a. Make sure there are no stickers or any other obstructions over the glass of the infrared sensing system and vision system;
 - b. Use a soft cloth if there is any dirt, dust, or water on the glass of the vision systems and infrared sensing systems. DO NOT use any cleaning product that contains alcohol;
 - c. Contact DJI Support if there is any damage to the glass of infrared sensing system and vision system.

Propellers

There are two types of propellers, which are designed to spin in different directions. Make sure to match the propellers and motors by following the instructions.

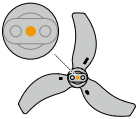
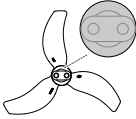
Propellers	With Orange Marks	Without Orange Marks
Illustration		
Mounting Position	Attach to the motors of the marked arm.	Attach to the motors of the unmarked arm.

Attaching and Detaching the Propellers

Attach the marked propellers to the motors of the marked arm, and the unmarked propellers to the motors of the unmarked arm. Use the 1.5mm screwdriver from the aircraft package to mount the propellers. Make sure the propellers are secure.

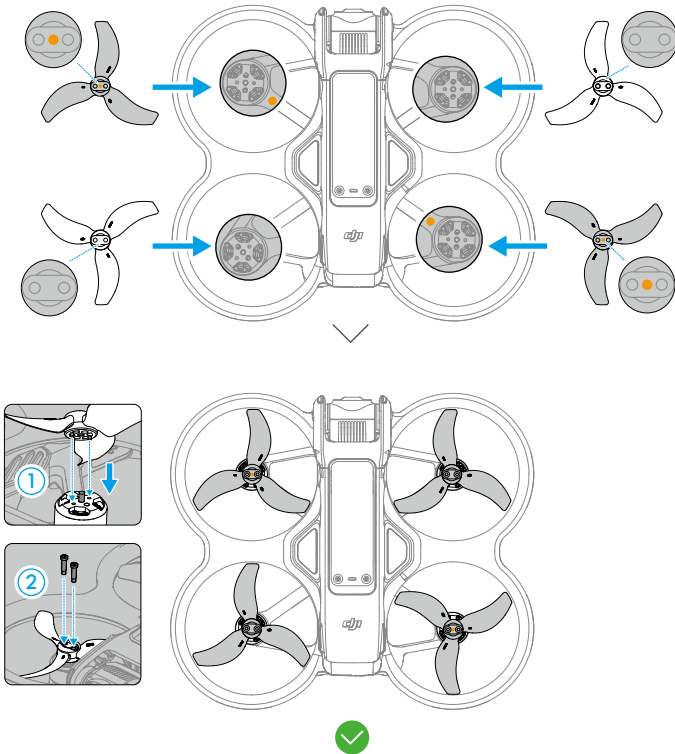

Use the screwdriver from the aircraft package to loosen the screws and detach the propellers from the motors.

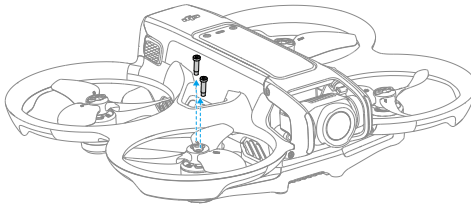

-
- ⚠ • Propeller blades are sharp. Handle with care.
 - Only use official DJI propellers. DO NOT mix propeller types.
 - Propellers are consumable components. Purchase additional propellers if necessary.
 - Make sure to only use the screwdriver from the aircraft package for mounting propellers. Using other screwdrivers may damage the screws.
 - If a propeller is broken, remove the propeller and screws on the corresponding motor and discard them.
 - Make sure that the propellers and motors are installed securely before each flight. Check to make sure the screws on the propellers are tightened after every 30 hours of flying time (approx. 60 flights).
 - Make sure that all propellers are in good condition and clean (without any foreign matter in or on them) before each flight. DO NOT use aged, chipped, or broken propellers. Clean the propellers with a soft, dry cloth if there is any foreign matter attached.
 - To avoid injury, stay away from rotating propellers or motors.
 - To avoid damaging the propellers, pack the aircraft correctly for transportation or storage. DO NOT squeeze or bend the propellers. If the propellers are damaged, the flight performance may be affected.
 - Make sure the motors are mounted securely and rotating smoothly. Land the aircraft immediately if a motor is stuck and unable to rotate freely.
 - DO NOT attempt to modify the structure of the motors.
 - DO NOT touch or let hands or body parts come in contact with the motors after flight, as they may be hot.
 - DO NOT block any of the ventilation holes on the motors or the body of the aircraft.
 - Make sure the aircraft beeps when powered on.
-

Intelligent Flight Battery

The aircraft can be used with DJI Avata 2 Intelligent Flight Battery (BW520-2150-17.76). This battery is a 14.76V, 2150mAh battery that adopts high-energy battery cells and uses an advanced battery management system.

Warnings



• Refer to the Safety Guidelines and the stickers on the battery before use. Users shall take full responsibility for all operation and usage.

1. DO NOT charge an Intelligent Flight Battery immediately after flight as it may be too hot. Wait for the battery to cool down to the charging temperature before charging again.
2. To prevent damage, the battery only charges when the temperature is between 5° and 40° C (41° and 104° F). The ideal charging temperature is from 22° to 28° C (71.6° to 82.4° F). Charging stops automatically if the temperature of the battery cells exceed 55° C (131° F) during charging.
3. Low Temperature Notice:
 - a. Batteries cannot be used in extremely low-temperature environments of lower than -10° C (14° F).
 - b. Battery capacity is significantly reduced when flying at low temperatures from -10° to 5° C (14° to 41° F). Make sure to fully charge the battery before takeoff. It is recommended to hover the aircraft in place for a while to heat the battery.
 - c. When in low-temperature environments, end the flight as soon as the goggles display the low battery voltage warning.
 - d. To ensure optimal performance, keep the battery temperature above 20° C (68° F).
 - e. The reduced battery capacity in low-temperature environments reduces the wind speed resistance performance of the aircraft. Fly with caution.
 - f. Take extra caution when flying at a high elevation with a low temperature.
4. To prevent swelling, the battery automatically discharges to 96% of the battery level when it is idle for three days, and automatically discharges to 60% of the battery level when it is idle for nine days. Note that it is normal for the battery to emit heat during the discharging process.
5. Over-discharging will lead to serious damage of the battery. If the battery level is too low, the battery will enter Hibernation mode to prevent over-discharge.

- Over-discharge protection is enabled and discharging stops automatically to prevent over-discharge when the battery is not in use. Charge the battery to wake it from over-discharge protection before using again. Over-discharge protection is not enabled when the battery is in use.
- Fully charge the battery at least once every three months to maintain battery health. If the battery is not used for an extended period, battery performance may be affected or may even cause permanent battery damage.
- For safety purposes, keep the batteries at a low power level in transit. Before transportation, it is recommended to discharge the batteries to 30% or lower.

Inserting/Removing the Battery

Insert the Intelligent Flight Battery into the battery compartment of the aircraft. Make sure the battery is fully inserted with a clicking sound, which indicates the battery buckles are securely fastened.

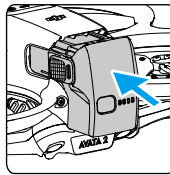

Press the textured part of the battery buckles on the sides of the battery to remove it from the compartment.

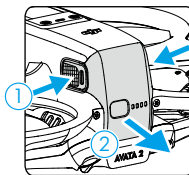

-
- ⚠**
- DO NOT insert or remove the battery while the aircraft is powered on.
 - Make sure the battery is inserted with a clicking sound. DO NOT take off when the battery is not securely mounted, as this may cause poor contact between the battery and the aircraft and present hazards. Make sure the battery is mounted securely.
-

Using the Battery

Checking the Battery Level

Press the power button once to check the current battery level.

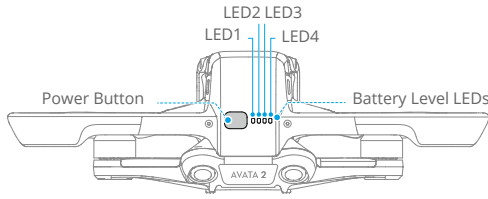

The battery level LEDs display the power level of the battery during charging and discharging. The statuses of the LEDs are defined below:

- LED is on.
- LED is flashing.
- LED is off.

LED1	LED2	LED3	LED4	Battery Level
				88%-100%
				76%-87%
				63%-75%
				51%-62%
				38%-50%
				26%-37%
				13%-25%
				0%-12%

Powering On/Off

Press the power button once and then press and hold for two seconds to power the aircraft on or off. The battery level LEDs display the battery level when the aircraft is powered on. The battery level LEDs turn off when the aircraft is powered off.

Updating Firmware

If an additional battery needs to be updated, insert it into the aircraft and power it on. A prompt will appear in the goggles to update the battery. Make sure to update the battery before takeoff.

The table below shows battery information during the update process and corresponding LED blinking patterns.

Blinking Pattern				Information
LED1	LED2	LED3	LED4	
				Updating battery firmware
				Firmware update failed

- If the update fails, reinsert the battery into the aircraft and power on, and retry the firmware update using DJI Assistant 2 (Consumer Drones Series). Refer to the Firmware Update section for more information.

Charging the Battery

Fully charge the battery before each use. It is recommended to use the charging devices provided by DJI, such as the DJI Avata 2 Two-Way Charging Hub, DJI 65W Portable Charger or other USB Power Delivery chargers. The DJI Avata 2 Two-Way Charging Hub and the DJI 65W Portable Charger are both optional accessories. Visit the official DJI online store for more information.

-
-  • When charging a battery mounted in the aircraft, the maximum charging power supported is 30 W.
-

Using a Charger

1. Make sure the battery has been correctly installed in the aircraft.
2. Connect a charger to an AC power supply (100-240 V, 50/60 Hz; use a power adapter if necessary).
3. Connect the charger to the charging port on the aircraft.
4. The battery level LEDs display the current battery level during charging.
5. The battery is fully charged when all the battery level LEDs are off. Detach the charger when the battery is fully charged.

-
-  • The battery cannot be charged if the aircraft is powered on.
-

Using the Charging Hub



Visit the link below to watch the tutorial videos for DJI Avata 2 Two-Way Charging Hub.



<https://s.dji.com/guide77>

When used with a compatible charger, the DJI Avata 2 Two-Way Charging Hub can charge up to three DJI Avata 2 Intelligent Flight Batteries in sequence from high to low power level. After the Intelligent Flight Batteries are inserted, the charging hub can supply power to external devices via the USB-C port, such as a remote controller or a mobile phone. The charging hub can also use the power accumulation function to transfer the remaining power of multiple low-power batteries into the battery with the highest remaining power.

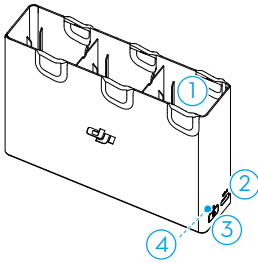

1. Battery Port
2. USB-C Port
3. Function Button
4. Status LED

- ⚠ • When using the charging hub to charge the Intelligent Flight Batteries, it is recommended to use the DJI 65W Portable Charger or a USB Power Delivery charger. When used with the DJI 65W Portable Charger, the charging hub can fully charge one Intelligent Flight Battery in approximately 45 minutes.
- The charging hub is only compatible with the BWX520-2150-14.76 Intelligent Flight Battery. DO NOT use the charging hub with other battery models.
 - Place the charging hub on a flat, stable surface with good ventilation when charging an external device or accumulating power. Make sure the device is properly insulated to prevent fire hazards.
 - DO NOT touch the metal terminals on the battery ports. Clean the metal terminals with a clean, dry cloth if there is any noticeable buildup.
 - Make sure to charge batteries with low battery power in time. It is recommended to store the batteries in the charging hub.

Charging Intelligent Flight Batteries

1. Insert the batteries into the charging hub until it clicks into place.
2. Connect the charging hub to a power outlet using a USB-C charger. The Intelligent Flight Battery with the highest power level will be charged first, and then the rest will be charged in sequence according to their power levels. The status LED indicates the battery level during charging. Refer to the Status LED Indicator Descriptions for more information about the blinking patterns of the status LED indicator. Press the function button to check the battery level of the inserted batteries.
3. The battery can be stored in the charging hub after charging. Remove the battery from the charging hub for use.

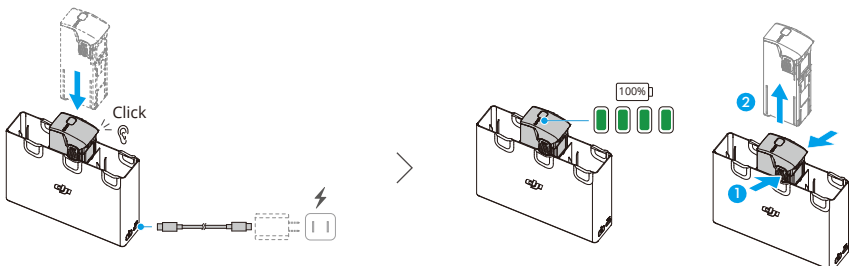

Using the Charging Hub as a Power Bank

1. Insert an Intelligent Flight Battery into the charging hub. Connect an external device via the USB-C port, such as a mobile phone or remote controller.
2. The battery with the lowest power level will be discharged first, followed by the remaining batteries which will be discharged sequentially. To stop charging the external device, disconnect the external device from the charging hub.

-
- ⚠️ • If the remaining charge of a battery is lower than 7%, the battery cannot charge the external device.
- Press the function button to activate charging if charging does not start automatically.
-

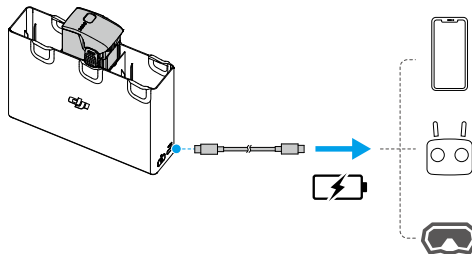

Power Accumulation

1. Insert more than one battery into the charging hub, and press and hold the function button until the status LED turns green. When the status LED of the charging hub pulses green, the charge is transferred from the battery with the lowest power level to the battery with the highest power level.
2. To stop accumulating power, press and hold the function button until the status LED turns yellow. After stopping power accumulation, press the function button to check the power level of the batteries.

-
- ⚠️ • Power accumulation stops automatically in the following situations:
- a. The receiving battery is fully charged, or the power of the output battery is lower than 5%.
 - b. A charger or external device is connected to the charging hub or any battery is inserted or withdrawn from the charging hub during power accumulation.
 - c. Power accumulation is interrupted for more than 15 minutes due to abnormal battery temperature.
- After power accumulation, charge the battery with the lowest power level as soon as possible to avoid over-discharge.
-

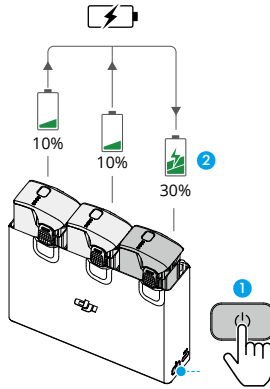

Status LED Indicator Descriptions

Blinking Pattern	Description
—	Solid yellow The charging hub is idle
—	Pulses green Charging the battery or accumulating power
—	Solid green All batteries fully charged or are supplying power to external devices
.....	Blinks yellow Temperature of batteries is too low or too high (no further operation needed)
—	Solid red Power supply or battery error (remove and reinsert the batteries or unplug and plug in the charger)

Battery Protection Mechanisms

The battery level LEDs can display battery protection notifications triggered by abnormal charging conditions.

Battery Protection Mechanisms					
LED1	LED2	LED3	LED4	Blinking Pattern	Status
				LED2 blinks twice per second	Overcurrent detected
				LED2 blinks three times per second	Short circuit detected
				LED3 blinks twice per second	Overcharge detected
				LED3 blinks three times per second	Over-voltage charger detected
				LED4 blinks twice per second	Charging temperature is too low
				LED4 blinks three times per second	Charging temperature is too high

If any of the battery protection mechanisms are activated, unplug the charger, and plug it in again to resume charging. If the charging temperature is abnormal, wait for it to return to normal. The battery will automatically resume charging without the need to unplug and plug the charger again.

Gimbal and Camera

Gimbal Profile

The gimbal of the aircraft stabilizes the camera, allowing users to capture clear and steady images and videos at a high flight speed.

Gimbal Angle

The gimbal has a control tilt range of -85° to 80° . Use the remote control devices to control the tilt of the camera.

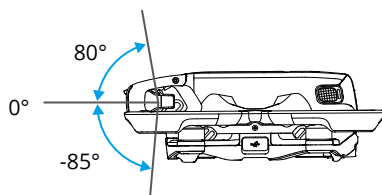

Gimbal Mode

The gimbal mode will automatically switch according to the flight mode.

Normal/Sport mode: The gimbal is in attitude stabilization mode. The tilt angle of the gimbal remains stable relative to the horizontal plane, which is suitable for shooting stable images.

Manual mode: The gimbal is in lock mode. The tilt angle of the gimbal remains stable relative to the aircraft body.



- Make sure there are no stickers or objects on the gimbal before taking off. DO NOT tap or knock the gimbal after the aircraft is powered on. Take off the aircraft from open and flat ground to protect the gimbal.
 - Precision elements in the gimbal may be damaged by a collision or impact, which may cause the gimbal to function abnormally. Make sure to protect the gimbal from damage.
 - Avoid getting dust or sand on the gimbal, especially in the gimbal motors.
 - A gimbal motor error may occur if the aircraft is on uneven ground, the gimbal is obstructed, or the gimbal experiences a collision or crash.
 - DO NOT apply external force to the gimbal after the aircraft is powered on.
-

-
- ⚠ • DO NOT add any extra payload other than an official accessory to the gimbal, as this may cause the gimbal to function abnormally or even lead to permanent motor damage.
- Make sure to remove the gimbal protector before powering on the aircraft. Make sure to mount the gimbal protector when the aircraft is not in use.
 - Flying in heavy fog or clouds may make the gimbal wet, leading to temporary failure. The gimbal will recover full functionality once it is dry.
-

Warnings

1. DO NOT expose the camera lens to an environment with laser beams, such as a laser show, or point the camera at intense light sources for an extended period, such as the sun on a clear day, in order to avoid damaging the sensor.
2. Make sure the temperature and humidity are within suitable ranges for the camera during use and storage.
3. Use a lens cleaner to clean the lens to avoid damage or poor image quality.
4. DO NOT block any ventilation holes on the camera as the heat generated may damage the device or injure the user.
5. If offline stabilization software such as Gyroflow is used for post-processing the recorded videos, make sure to disable EIS and set the camera FOV to Wide in the goggles when recording.
6. The cameras may not focus correctly in the following situations:
 - a. Shooting dark objects far away.
 - b. Shooting objects with repeating identical patterns and textures or objects without clear patterns or textures.
 - c. Shooting shiny or reflective objects (such as street lighting and glass).
 - d. Shooting flashing objects.
 - e. Shooting fast-moving objects.
 - f. When the aircraft or the gimbal is moving fast.
 - g. Shooting objects with varying distances in the focus range.

Footage Storage and Export

Footage Storage

The aircraft comes with a 46GB internal storage. Photos and videos can be saved in the internal storage of the aircraft when no microSD card is available. The aircraft supports the use of a microSD card to store photos and videos. A UHS-I Speed Grade 3 rating or above microSD card is required due to the fast read and write speeds necessary for high-resolution video data. Refer to the Specifications for more information about recommended microSD cards.

It is recommended to use a microSD card for large data storage.



- Photos and videos recorded by the aircraft can be previewed. Insert the microSD card of the aircraft into the microSD card slot of the goggles.



- DO NOT remove the microSD card from the aircraft while it is powered on or taking photos or videos. Otherwise, the microSD card may be damaged.
- Check camera settings before use to ensure they are configured correctly.
- Before shooting important photos or videos, shoot a few images to test whether the camera is operating correctly.
- Make sure to power off the aircraft correctly. Otherwise, the camera parameters will not be saved and any recorded videos may be affected. DJI is not responsible for any loss caused by an image or video recorded in a way that is not machine-readable.
- The internal storage performance may be lowered after using for a long time. Follow the instructions in the goggles to migrate and format the data to ensure good internal storage performance.

Footage Export

Use QuickTransfer to export the footage to a mobile device. Refer to the QuickTransfer section for more information.

1. Connect the aircraft to a computer using a data cable, export the footage in the internal storage of the aircraft or in the microSD card mounted on the aircraft. The aircraft does not need to be powered on during the exporting process.
2. Remove the microSD card from the aircraft and insert it into a card reader, and export the footage in the microSD card through the card reader.

QuickTransfer

The aircraft can connect directly to mobile devices via Wi-Fi, enabling users to download photos and videos from the aircraft to the mobile device through DJI Fly at a high rate.

Follow the steps below to export footage using QuickTransfer:

1. Power on the aircraft and wait until the self-diagnostic tests of the aircraft are complete.
2. Enable Bluetooth, Wi-Fi, and location services on the mobile device.
3. Run DJI Fly, tap the QuickTransfer card on the bottom left corner of the home screen,  and select the aircraft to be connected. When connecting DJI Fly to the aircraft for the first time, press and hold the power button for two seconds after a prompt appears on the app. The battery level LEDs blink from inside to out and then turn solid. DJI Fly will prompt users whether to connect to the aircraft or not.
4. Once successfully connected, the files on the aircraft can be accessed and downloaded at high speed.



- When the aircraft is connected to DJI Fly using QuickTransfer, the aircraft will be disconnected from the goggles and the remote controller. Connection will be automatically restored after exiting QuickTransfer. If DJI Fly is closed abnormally, connection can only be automatically restored after restarting the aircraft.



- The maximum download rate can only be achieved in countries and regions where the 5.8 GHz frequency is permitted by laws and regulations, when using devices that support 5.8 GHz frequency band and Wi-Fi connection, and in an environment without interference or obstruction. If 5.8 GHz is not allowed by local regulations (such as in Japan), or the mobile device of the user does not support the 5.8 GHz frequency band, or the environment has severe interference, then QuickTransfer will use the 2.4 GHz frequency band and its maximum download rate will be significantly lowered.
 - Use QuickTransfer in an unobstructed environment with no interference and stay away from sources of interference such as wireless routers, Bluetooth speakers, or headphones.
 - DO NOT press the power button of the aircraft for a long time to avoid triggering the linking process.
-

DJI Goggles 3

DJI Goggles 3

DJI Goggles 3 are equipped with two high-performance screens and ultra-low-latency image transmission for use with DJI aircraft, allowing for a real-time aerial First Person View (FPV) experience. DJI Goggles 3 supports the Head Tracking function. With this function, the aircraft and gimbal can be controlled using head movements. When used with the DJI Motion Controller 3, users can control the aircraft and the gimbal camera freely to meet their shooting needs in various scenarios.

To provide a more comfortable experience, the goggles support diopter adjustment so that glasses are not required during use. Two cameras are positioned on the front side of the goggles, in order to allow users to view the surrounding environment via Real View without removing the goggles. The goggles can also share the liveview to a mobile device via Wi-Fi.

Operating the Goggles

Buttons

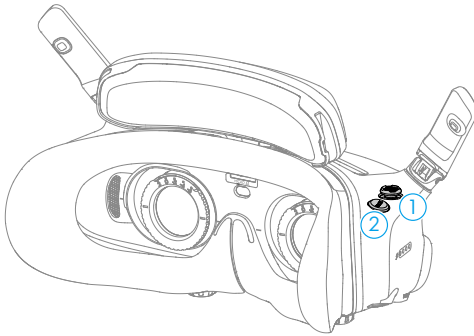

1. 5D Button

Press or push to the right to open the menu from the FPV view of the goggles. Push forward to open the camera settings panel and push backward to open the shortcut menu.

After the settings panel is opened, push to navigate through the menu or adjust the parameter value. Press to confirm the selection.

2. Back Button

Press to return to the previous menu or exit the current view.

AR Cursor

Before takeoff or when using the lock button to trigger the aircraft to hover, users can use the AR Cursor (the white line with a circle at the end) to interact with the screen of the goggles.



-
-  • AR Cursor cannot function properly when being used on moving objects, such as cars and ships.
-

Recenter the Cursor

If the cursor is not displayed on the screen of the goggles, hold the motion controller as shown below, and then press and hold the dial on the left side of the motion controller to recenter the cursor.

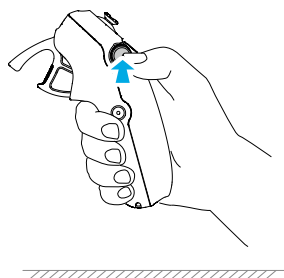

If the cursor still cannot be found, tilt the motion controller up or down until the cursor appears on the screen.

Operating the Menu

- Using motion controller movements, move the cursor to the arrow on the left side of the screen. Gently press the accelerator to the first stop position, then the cursor will become small and the menu will be opened.

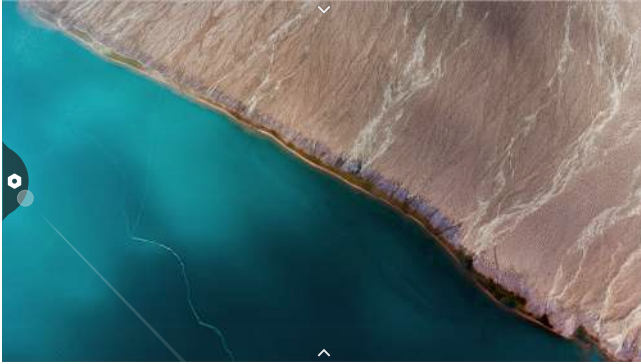

Use the joystick on the motion controller to scroll up or down in the menu.

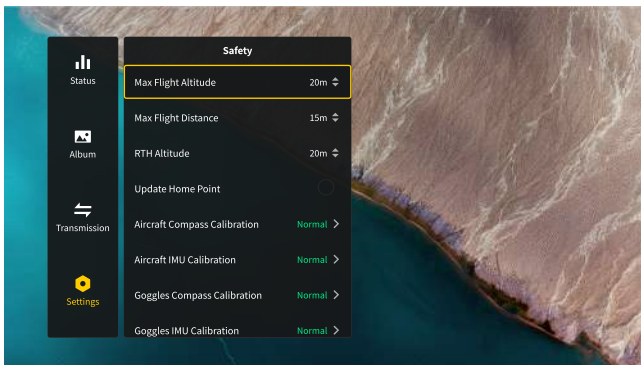
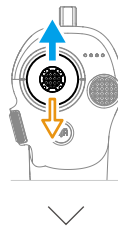

To exit or return to the previous menu, push the accelerator forward, or gently press the accelerator when the cursor is on any empty spot on the screen.

- Move the cursor to the arrow on the top of the screen, press the accelerator to enter the shortcut menu, and configure settings such as Recording or Enhanced Display.



- Move the cursor to the arrow on the bottom of the screen, press the accelerator to enter camera settings, and configure settings for the parameters of the aircraft camera.



Controlling Video Playback

When previewing photos or videos stored on the microSD card of the goggles, the cursor can be used to control playback, or complete other operations such as:

- Press the accelerator to pause or continue to play, push the accelerator forward to exit.
- Move the cursor left or right while pressing the accelerator down to adjust the progress bar.
- Move the cursor to the arrow on the top of the screen, press down the accelerator to enter playback settings and adjust the screen brightness or volume.

Goggles Screen

FPV View

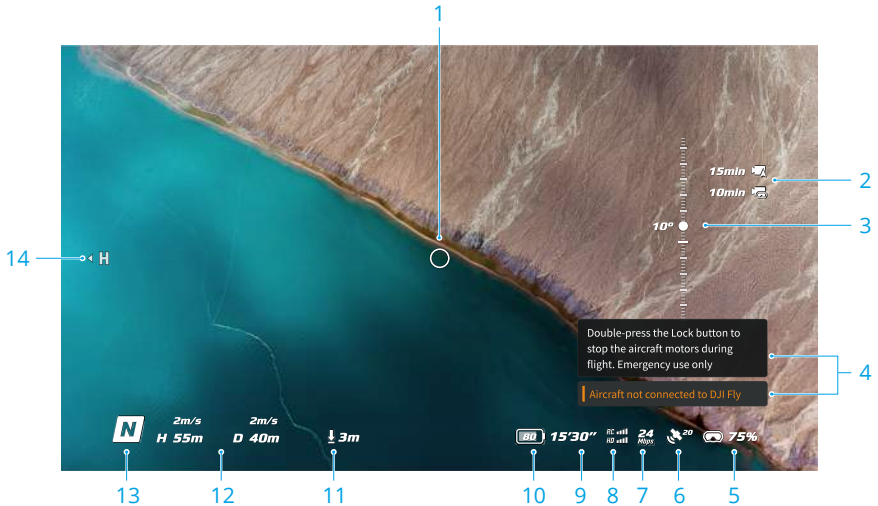

1. Flight Direction Indicator

When controlling the aircraft with the motion controller, the circle indicates the direction in which the aircraft is heading.

2. Storage Information

Displays the remaining capacity of the aircraft or goggles storage.

3. Gimbal Slider

Displays the gimbal tilt angle.

4. Prompts

Displays notifications and information such as when a new mode is applied or the battery level is low.

5. Goggles Battery Level

Displays the battery level of the goggles.

6. GNSS Status

Displays the current strength of the aircraft GNSS signal.

If the devices are not used for an extended period of time, it may take longer than usual to search for the GNSS signal. If the signal is unobstructed, it takes approximately 20 seconds to search for the GNSS signal when powering on and off within a short period of time. When the icon is white, the GNSS signal is strong. When the icon is orange, the GNSS signal is weak. When the icon is red, the GNSS signal is extremely weak.

7. Video Bitrate

Displays the current video bitrate of the liveview.

8. Remote Controller and Image Transmission Signal Strength

Displays the signal strength of the remote control device, and the image transmission signal strength between the aircraft and the goggles.

The icon is white when the signal is strong, and turns gray when the signal is lost.

The icon is orange when the signal is moderately weak, and turns red when the signal is extremely weak. A prompt bar of the same color is displayed in the bottom of the flight liveview.

9. Remaining Flight Time

Displays the remaining flight time of the aircraft.

10. Aircraft Battery Level

11. Distance to the Ground

Displays the current altitude information of the aircraft from the ground when the aircraft is less than 10 m above the ground.

12. Flight Telemetry

Displays the horizontal distance (D) between the aircraft and the Home Point, height (H) from the Home Point, aircraft horizontal speed, and aircraft vertical speed.

13. Flight Modes

Displays the current flight mode.

14. Home Point

Indicates the relative position of the Home Point.

Shortcut Menu

Push the 5D button backward to open the shortcut menu from the FPV view and access the quick controls of the following functions:

- Take a photo, or start/stop recording
- Enable/disable Enhanced Display
- Enable/disable Head Tracking
- Enable/disable Share Liveview to Mobile Device via Wi-Fi
- Enable/disable Easy ACRO
- Enable/disable Goggles Defog
- Adjust brightness

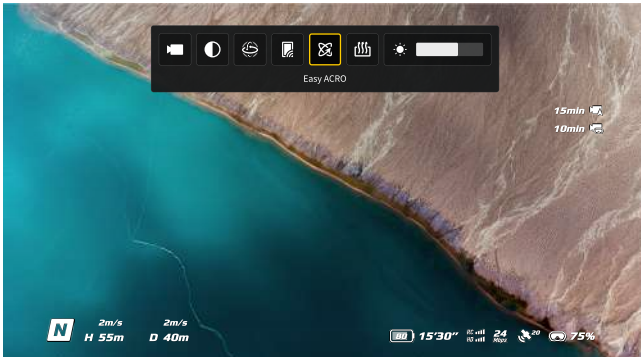
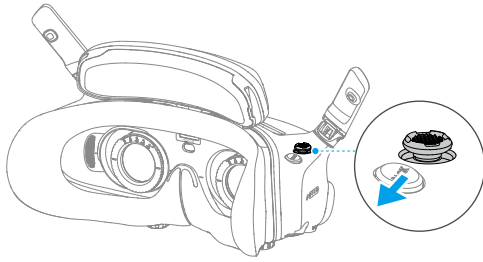

Camera Settings

Push the 5D button forward from the FPV view to open the camera settings panel and change camera-related parameters.

In the parameter panel, push to the right to view and set more parameters.

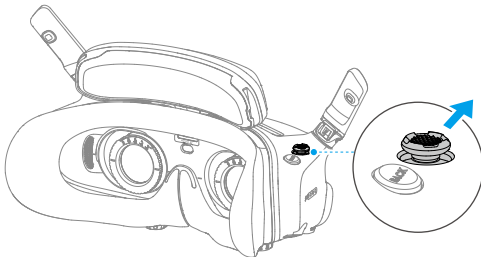

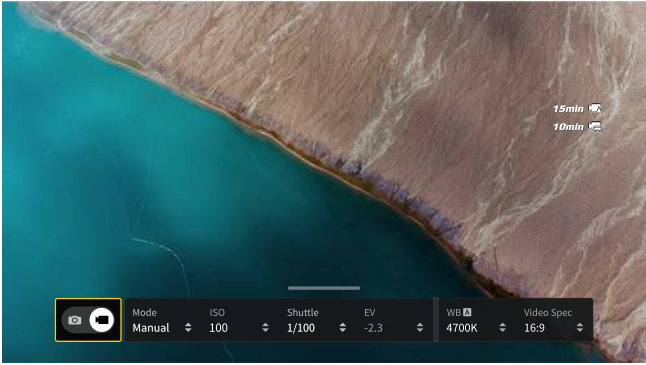

Goggles Menu

Press down the 5D button or push it to the right to open the menu from the FPV view.

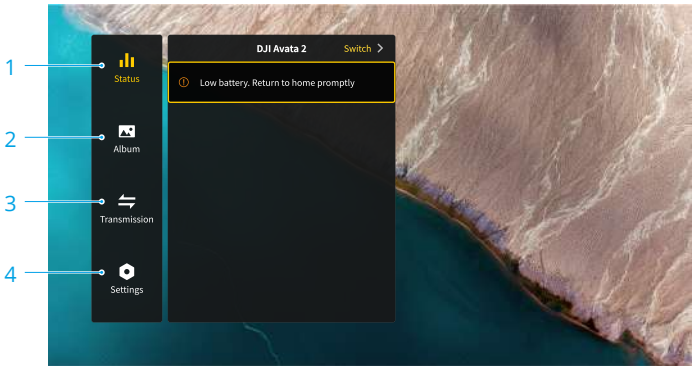
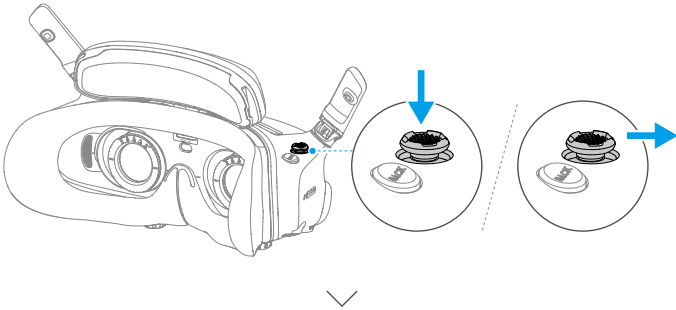

1. Status

- Displays the in-use aircraft model and detailed information of prompt alerts.
- Use the switch function in the upper right corner to change the aircraft.

2. Album

Shows the photos or videos stored on the microSD card of the goggles. Select any file to preview.

3. Transmission

The Transmission menu has a Pilot sub-menu and Audience sub-menu.

- The video transmission mode for the current device can be set under the Pilot sub-menu, including but not limited to the following:
 - a) Enable or disable Broadcasting mode. The device number will be displayed when Broadcasting mode is enabled so that other devices can find the device and enter the channel to see the flight liveview.
 - b) Disable the Focus mode, or set to auto.
 - c) Set the Channel mode to auto or manual. It is recommended to select auto so that the video transmission will automatically switch between different frequency bands and select the channel with the best signal.
 - d) Set the frequency band. If the channel mode is set to manual, either 2.4 or 5.8 GHz can be selected.
 - e) Set the bandwidth of the video transmission. The number of channels available varies according to the bandwidth. The channel with the best signal strength can be manually selected. The higher the bandwidth, the higher video transmission rate and clearer image quality. However, there will also be a higher chance of wireless interference and the amount of equipment that can be accommodated will be more limited. To avoid interference in a multiplayer competition, manually select a fixed bandwidth and channel.
- If any nearby video transmission device turns on the Broadcasting mode, the device and its signal strength can be viewed in the Audience sub-menu. Select a channel to see the flight liveview.

4. Settings

- Safety
 - a) Set the safety configurations such as max flight altitude, max flight distance, and RTH altitude. Users can also update the Home Point, and view the IMU and compass status of the aircraft or the goggles and calibrate them if necessary.
 - b) Camera View Before Loss helps to find the location of the aircraft on the ground by using the cached video of the aircraft 30 seconds before signal is lost. If the aircraft still has signal and battery power, turn on ESC beeping to locate the aircraft using a beeping sound that is emitted from the aircraft.
 - c) Advanced Safety Settings include the following:
 - Aircraft Signal Lost Action: The aircraft behavior can be set to hover, land, or RTH when the remote controller signal is lost.
 - Emergency Propeller Stop (disabled by default): When enabled, the motors of the aircraft can be stopped mid-flight anytime once the user presses the motion

controller lock button four times. If the switch is disabled, the motors can only be stopped with this action in an emergency, such as if a collision occurs, a motor stalls, the aircraft rolls in the air, or the aircraft is out of control and is ascending or descending quickly.



• Stopping motors mid-flight will cause the aircraft to crash. Operate with caution.

- Control
 - a) Configure remote controller-related functions, such as setting the stick mode, customizable buttons, and calibrating the IMU and compass.
 - b) View motion controller instructions, switch Handedness, adjust Gain Tuning, or calibrate the motion controller.
 - c) Calibrate the gimbal, adjust the gimbal tilt speed, set the unit, or use turtle mode to flip the overturned aircraft upright.
 - d) View the goggles tutorial.

- Camera

- a) Set the aspect ratio, video quality, video format, gridlines, storage device, format the SD card, and so on.



• Data cannot be recovered after formatting. Operate with caution.

- b) Advanced Camera Settings:

- Set the recording device, screen related parameters, enable or disable auto record at takeoff, and so on.
- Camera View Recording (enabled by default): If disabled, the recording of the goggles screen will not include the OSD elements.

- c) Select Reset Camera Parameters to restore all camera settings to default.

- Display

- a) Adjust screen brightness, display scaling, and display or hide the Home Point.
- b) Goggles Defog: If enabled, the cooling fan will keep running at high speed to alleviate the fogging of the lenses.
- c) Set the display of Real View.

- About

- a) View device information, such as the serial number, the firmware of the goggles, and linked devices.
- b) Set the system language.
- c) OTG Wired Connection: In this mode, the goggles can be connected to the PC via the USB-C fast charging cable.
- d) View the compliance information.
- e) Reset the goggles and the linked devices to their default settings.
- f) Clear All Device Data: All user data generated during use and stored on the aircraft will be erased.

Goggles Footage Storage and Export

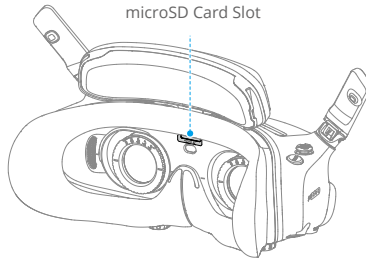

Footage Storage

The goggles support the installation of a microSD card. After a microSD card is inserted, if Record With is set to both the aircraft and the goggles while the aircraft is recording video the goggles will simultaneously record the flight live view displayed on the screen and store it on the microSD card of the goggles.

Footage Export

To export the recorded footage, follow the steps below:

1. Power on the goggles.
2. Connect the USB-C port of the goggles to a PC using a USB-A to USB-C cable, and follow the on-screen prompts to export the footage.

⚠ • If the goggles are connected to a PC via the USB-C fast charging cable, go to the goggles menu and select Settings > About, and enter the OTG Wired Connection mode to export the footage.

The screen recording includes the OSD elements by default. To record the screen without the OSD elements, change the settings as shown below:

1. Open the goggles menu.
2. Select Settings > Camera > Advanced Camera Settings, and disable Camera View Recording.

Formatting the SD Card

To format the microSD card, follow the steps as shown below:

1. Open the goggles menu.
2. Select Settings > Camera > Format
3. Select the storage device to format and follow the on-screen instructions to complete the operation.

⚠ • Data cannot be recovered after formatting. Operate with caution.

Real View

DJI Goggles 3 are equipped with binocular cameras, in order for users to view the surrounding environment without removing the goggles.

Tap twice firmly on the right side of the goggles, or press twice on the dial of the motion controller to enter Real View.

Perform the same action again to exit and return to the flight liveview.

Enter the goggles menu, select Settings > Display, and then Real View can be set to 2D or 3D.

3D will bring a more immersive three-dimensional real view. Please select based on personal preference.

Real View PiP

When the goggles are used with the aircraft, Real View supports displaying the real-time flight liveview.

1. Enter the goggles menu, select Settings > Display, and then enable Real View PiP.
2. Tap twice firmly on the right side of the goggles, or press twice on the motion controller dial, the flight liveview will be displayed in the upper left corner of the real view. Both the surroundings and the aircraft video transmission will be displayed on the goggles screen simultaneously.



- If the Real View is set to 3D, the flight liveview cannot be displayed on the screen simultaneously.



- When using Real View PiP, the flight liveview is only used to show the status of the aircraft. DO NOT rely on this screen for flight.
-

Liveview Sharing

DJI Goggles 3 can share a flight liveview via three different methods.



- Power on the aircraft, goggles, and remote control device. Make sure all the devices are linked.



- Operate Liveview Sharing prior to taking off, or when the aircraft is braking or hovering, to avoid interfering with the pilot's operation.
 - The goggles only support connecting to one mobile device for sharing the liveview either in wireless or wired connection.
 - When connected to a mobile device, liveview sharing will be paused if the goggles switch to Real View, and the sharing will be recovered when the goggles switch back the flight liveview.
 - When connected to a mobile device, liveview sharing will be paused when viewing the images or videos in the album. Exit the album to recover sharing.
-

Wired Connection with Mobile Device

1. It is recommended to use a suitable data cable or the USB-C OTG cable provided to connect the mobile device to the USB-C port on the goggles.
2. Launch DJI Fly app and tap GO FLY in the lower right corner of the screen to enter the liveview.

Wireless Connection with Mobile Device

1. Open the shortcut menu, and select  Share Liveview to Mobile Device via Wi-Fi.
2. Turn on Wi-Fi and Bluetooth on your mobile device, and enable the Location feature on your phone.
3. Launch the DJI Fly app, a new device available for Wi-Fi connection will appear in a box on the home page.
4. Tap the box and select the goggles to be connected.
5. When connecting DJI Fly to the goggles for the first time, press and hold the power button on the goggles for two seconds when the prompt appears. The battery level LEDs blink from inside to out and then turn solid. DJI Fly will prompt the user to connect to the goggles if needed. Select Join.
6. Tap Watch Liveview to access the liveview from the goggles.



- DO NOT press the power button of the goggles for a long period of time to avoid triggering the linking process.
 - If Share Liveview to Mobile Device via Wi-Fi is enabled, wired connection with mobile device is not supported.
 - In wireless connection mode, disconnect the goggles from the current connected mobile device before connecting the goggles to another new mobile device for liveview sharing.
 - If 5.8 GHz is not allowed by local regulations (such as in Japan), Share Liveview to Mobile Device via Wi-Fi cannot be used.
-



Broadcasting to Other Goggles

Broadcasting mode is available for sharing the liveview to other goggles if there are other DJI Goggles 3 nearby.

1. Enter the goggles menu, select Transmission and enter the Pilot sub-menu.
2. Turn on Broadcasting mode, and the device number will be displayed.
3. On the other DJI Goggles 3, enter the goggles menu, select Transmission and enter the Audience sub-menu.
4. If any nearby DJI Goggles 3 turns on the Broadcasting mode, the device and its signal strength can be viewed in the Audience sub-menu. Select the device number to access the liveview. Switching to Pilot sub-menu to exit the shared liveview.

Panorama/3D Video Playback

The goggles support playing panoramic videos and 3D videos, bringing you an immersive viewing experience.

1. Import panoramic/3D videos to a microSD card, and insert it into the goggles.
 2. Enter the goggles menu and then Album, then select the video file to play.
 3. Push the 5D button backward to open the playback menu, and select  Display Switch Settings.
 4. Set the display mode.
 - If the video is panoramic, select 2D first, and then set the FOV to panorama.
 - If the video is a 3D, first select the 3D display mode based on the video format, then select the FOV, and whether to reverse left and right.
 5. Exit the shortcut menu after confirming the selections, then the panoramic/3D video will be played based on the display settings.
-
-  • Refer to the Specifications for more information about the supported video formats.
- The goggles have no speaker but can be connected to headphones via the USB-C port. Only supports Type-C headphones and headphone adapters with built-in DAC (digital-to-analog converter).
-

DJI Motion Controller

DJI Motion Controller

Operation

Powering On/Off

Press the power button once to check the current battery level. Charge before using if the battery level is too low.

Press once then press again and hold for two seconds to power the motion controller on or off.

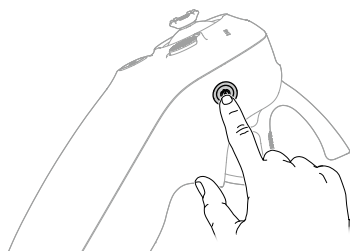

Charging the Battery

Use a USB-C cable to connect a charger to the USB-C port of the motion controller.

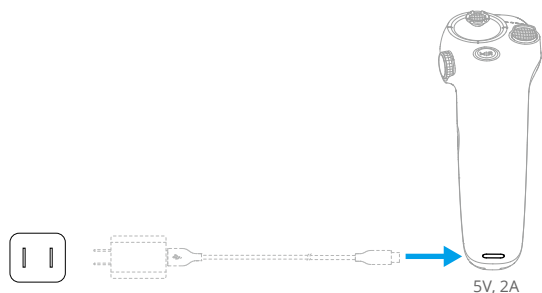

-
- ⚠️ Fully charge the remote controller before each flight. The remote controller sounds an alert when the battery level is low.
 - Fully charge the battery at least once every three months to maintain good battery health.
-

Button Features



Lock Button

- Takeoff: Press twice to start the aircraft motors, then press and hold to make the aircraft take off. The aircraft will ascend to approximately 1.2 m and hover.
- Landing: While the aircraft is hovering, press and hold to land the aircraft and stop the motors.
- Brake: Press during flight to make the aircraft brake and hover in place.



Joystick

- Move up or down to make the aircraft ascend or descend.
- Move it left or right to make the aircraft move left or right horizontally.

When Easy ACRO is enabled, move the joystick to perform different Easy ACRO actions.



Mode Button

- Press to switch between Normal and Sport mode.
- Press and hold to initiate RTH. When the aircraft is performing RTH, press the mode button or lock button once to cancel RTH.
- When the battery level is low and only sufficient to fly to the Home Point, a warning prompt will appear in the goggles and RTH will be triggered following the prompt. Press the mode button once to cancel the prompt.



Dial

- Press twice to switch between the flight liveview and Real View in the goggles.
- Scroll up or down to tilt the camera before takeoff or during RTH and landing.
- Scroll the dial to switch between Easy ACRO actions when Easy ACRO is enabled.
- Press and hold the dial to recenter the cursor on the screen when using AR Cursor.

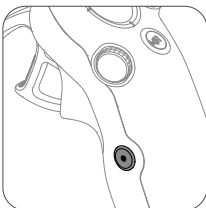

Shutter/Record Button

- Press once: Take a photo or start or stop recording.
- Press and hold: Switch between photo and video mode.

Accelerator



The accelerator is used for controlling aircraft orientation and acceleration. There are two stops when pressing the accelerator. After gently pressing the accelerator, users will feel noticeable resistance when the accelerator reaches the first stop.

- After gently pressing the accelerator to the first stop, users can adjust the aircraft orientation by tilting the top of the motion controller to the left or right. Note that the aircraft will not fly forward at this time.
- Press the accelerator past the first stop to fly in the direction of the circle in the goggles. Push the accelerator forward to fly the aircraft backward. Apply more pressure in either direction to accelerate.
- When the accelerator is not being pressed, the aircraft will hover.

Optimal Transmission Zone

The signal between all the devices is most reliable when the relative distance between the motion controller and the goggles is less than 3 m.



- ⚠ • It is recommended to use the device in an open, outdoor environment to avoid having obstacles between the motion controller and the goggles. Otherwise, the transmission may be affected.
 - In order to avoid interference, DO NOT use other wireless devices on the same frequency as the motion controller.
-

Motion Controller Alert

The remote controller sounds an alert when the battery level is between 6% and 10%. A low battery level alert can be canceled by pressing the power button. A critical battery level alert will sound when the battery level is less than 5% and cannot be canceled. The remote controller sounds an alert during RTH, which cannot be canceled.

Motion Controller Calibration

The compass, IMU, and accelerator of the motion controller can be calibrated.

Immediately calibrate any of the modules when prompted to do so:

1. Press down the 5D button in flight liveview to open the menu.
2. Select Settings > Control > Motion Controller > RC Calibration.
3. Select the module and follow the prompts to complete calibration.



- DO NOT calibrate the compass in locations with strong magnetic interference, such as near magnets, parking lots, or construction sites with underground reinforced concrete structures.
 - DO NOT carry ferromagnetic materials such as mobile phones during calibration.
-

DJI Fly App

DJI Fly App

Connect the goggles to the mobile device, launch DJI Fly, and enter the home screen. Users can do the following from the home screen:

- Discover recommended Fly Spots, check for GEO Zones and find information about local laws and regulations, watch function tutorials, and read product manuals.
- Visit the album to view photos and videos, or explore more shared footage from SkyPixel.
- Log in with your DJI account to check your account information and flight records.
- Update firmware, locate a lost aircraft using Find My Drone, visit the DJI Forum, or shop the DJI Store.

Tap GO FLY to display the video transmission, which allows you to share the FPV camera view.



- Fully charge your mobile device before launching DJI Fly.
 - Mobile cellular data is required when using DJI Fly. Contact your wireless carrier regarding data charges.
 - DO NOT accept phone calls or use texting features during flight if you are using a mobile phone as your display device.
 - Read all safety prompts, warning messages, and disclaimers carefully. Familiarize yourself with relevant regulations in your area. You are solely responsible for being aware of all relevant regulations and flying in a way that is compliant.
 - The use of the app is subject to DJI Fly Terms of Use and DJI Privacy Policy. These Terms of Use and Privacy Policy limit some of DJI's legal responsibilities. Read them carefully at <https://developer.dji.com/policies/>.
-

Appendix

Appendix

Specifications

DJI Avata 2

Takeoff Weight	Approx. 377 g
Dimensions	185×212×64 mm (L×W×H)
Max Ascent Speed	6 m/s (Normal mode) 9 m/s (Sport mode)
Max Descent Speed	6 m/s (Normal mode) 9 m/s (Sport mode)
Max Horizontal Speed (near sea level, no wind)	8 m/s (Normal mode) 16 m/s (Sport mode) 27 m/s (Manual mode)*
	* No faster than 19 m/s with the Manual mode in the EU regions.
Max Takeoff Altitude ^[1]	5000 m
Max Flight Time ^[2]	Approx. 23 mins
Max Hovering Time ^[3]	Approx. 23 mins
Max Flight Distance ^[4]	13.0 km
Max Wind Speed Resistance	10.7 m/s (Level 5)
Operating Temperature	-10° to 40° C (14° to 104° F)
Global Navigation Satellite System	GPS + Galileo + BeiDou
Hovering accuracy range	Vertical: ±0.1 m (with vision positioning) ±0.5 m (with GNSS positioning) Horizontal: ±0.3 m (with vision positioning) ±1.5 m (with GNSS positioning)
Internal Storage	46 GB
Camera	
Image Sensor	1/1.3-inch image sensor Effective Pixels: 12 MP
Lens	FOV: 155° Format Equivalent: 12 mm Aperture: f/2.8 Focus: 0.6 m to ∞
ISO Range	100-25600 (Auto) 100-25600 (Manual)

Shutter Speed	Video: 1/8000-1/30 s Photo: 1/8000-1/50 s
Max Image Size	4000×2256 (16:9) 4000×3000 (4:3)
Still Photography Mode	Single shot
Photo Format	JPEG
Video Resolution	4K (4:3): 3840×2880@30/50/60fps 4K (16:9): 3840×2160@30/50/60fps 2.7K (4:3): 2688×2016@30/50/60fps 2.7K (16:9): 2688×1512@30/50/120fps 1080p (4:3): 1440×1080@30/50/120fps 1080p (16:9): 1920×1080@30/50/120fps
Video Format	MP4 (H.264/H.265)
Max Video Bitrate	130 Mbps
Supported File System	exFAT
Color Mode	Standard D-Log M
Camera FOV	Supports standard mode, wide-angle mode, and super-wide-angle mode,
EIS	Supports RockSteady 3.0+ and HorizonSteady Can be disabled* * When stabilization is turned off, footage captured with the wide-angle view supports offline stabilization Gyroflow.
Gimbal	
Stabilization	Single-axis mechanical gimbal (tilt)
Mechanical Range	Tilt: -95° to 90°
Controllable Range	Tilt: -85° to 80°
Max Control Speed (tilt)	100°/s
Angular Vibration Range	±0.01°
Electronic Roll Axis	Real-time screen correction is unavailable during recording, but can be applied to the footage recorded on the drone.
Sensing	
Sensing Type	Downward and backward visual positioning
Downward	ToF Effective Measurement Height: 10 m Precise Hovering Range: 0.3-10 m Measurement Range: 0.3-20 m FOV: Horizontal 78°, Vertical 78°
Backward	Measurement Range: 0.5-20 m FOV: Horizontal 78°, Vertical 78°

Operating Environment	Diffuse reflective surfaces with discernible patterns, diffuse reflectivity > 20% (such as concrete pavement) Adequate lighting (lux > 15, normal indoor lighting conditions)
-----------------------	--

Video Transmission

Video Transmission System	O4
Live View Quality	1080p@30/50/60/100fps
Operating Frequency	2.4000-2.4835 GHz 5.170-5.250 GHz* 5.725-5.850 GHz* <small>* 5.170-5.250 GHz and 5.725-5.850 GHz can be used only in countries and regions where permitted by local laws and regulations.</small>
Transmitter Power (EIRP)	2.4 GHz: <33 dBm (FCC), <20 dBm (CE/SRRC/MIC) 5.1 GHz: < 23 dBm (CE) 5.8 GHz: <33 dBm (FCC), <30 dBm (SRRC), <14 dBm (CE)

Communication Bandwidth	Max 60 MHz
Max Transmission Distance (unobstructed, free of interference) ^[5]	FCC: 13 km (subject to the aircraft's max flight time) CE: 10 km SRRC: 10 km MIC: 10 km
Max Transmission Distance (unobstructed, with interference) ^[6]	Strong Interference: Urban landscape, approx. 1.5-4 km Medium Interference: Suburban landscape, approx. 4-10 km Low Interference: Suburb/seaside, approx. 10-13 km
Max Transmission Distance (obstructed, with interference) ^[7]	Low Interference and Obstructed by Buildings: approx. 0-0.5 km Low Interference and Obstructed by Trees: approx. 0.5-3 km
Max Download Speed	Wi-Fi: 25 MB/s* <small>* Measured in a laboratory environment with little interference in countries/regions that support both 2.4 GHz and 5.8 GHz. Download speeds may vary depending on the actual conditions.</small>

Lowest Latency	With DJI Goggles 3: 1080p/100fps Video Transmission Quality: 24 ms 1080p/60fps Video Transmission Quality: 40 ms
Max Video Bitrate	60Mbps
Antennas	4 antennas, 2T4R

Wi-Fi

Protocol	802.11a/b/g/n/ac
Operating Frequency	2.4000-2.4835 GHz 5.725-5.850 GHz
Transmitter Power (EIRP)	2.4 GHz: <20 dBm (FCC/CE/SRRC/MIC) 5.8 GHz: <20 dBm (FCC/SRRC), < 14 dBm (CE)

Bluetooth

Protocol	Bluetooth 5.0
Operating Frequency	2.4000-2.4835 GHz
Transmitter Power (EIRP)	<10 dBm

Intelligent Flight Battery

Capacity	2150 mAh
Weight	Approx. 145 g
Standard Voltage	14.76 V
Max Charging Voltage	17 V
Battery Type	Li-ion
Energy	31.7 Wh@0.5C
Charging Temperature	5° to 40° C (41° to 104° F)
Charging Time	With Charging Hub (60W max charging power): From 0 to 100%: approx. 45 min From 10 to 90%: approx. 30 min Directly Charging the Drone: (30W max charging power): From 0 to 100%: approx. 88 min From 10 to 90%: approx. 60 min

Charger

Recommended Charger	DJI 65W Portable Charger DJI 65W Car Charger USB Power Delivery charger
---------------------	---

Battery Charging Hub

Input	5-20 V, max 3 A
-------	-----------------

Charging Hub

Output (power accumulation)	Max 65 W
Output (charging)	Max 17 V
Output (USB)	5 V, 2 A
Charging Type	Three batteries charged in sequence.
Compatibility	DJI Avata 2 Intelligent Flight Battery

Storage

Recommended microSD Cards	SanDisk Extreme PRO 32GB U3 A1 V30 microSDHC Lexar Professional 1066x 64GB U3 A2 V30 microSDXC Lexar Professional 1066x 128GB U3 A2 V30 microSDXC Lexar Professional 1066x 256GB U3 A2 V30 microSDXC Lexar Professional 1066x 512GB U3 A2 V30 microSDXC Kingston CANVAS Go! Plus 64GB U3 A2 V30 microSDXC Kingston CANVAS Go! Plus 128GB U3 A2 V30 microSDXC Kingston CANVAS React Plus 64GB U3 A1 V90 microSDXC Kingston CANVAS React Plus 128GB U3 A1 V90 microSDXC Kingston CANVAS React Plus 256GB U3 A1 V90 microSDXC Samsung EVO Plus 512GB U3 A2 V30 microSDXC
---------------------------	---

- [1] Measured in a windless environment when taking off from an altitude of 5000 m and ascending vertically by 500 m, using Sport mode, and from 100% battery level until 20%. Data is for reference only. Always pay attention to reminders on the goggles' screens during your flight.
- [2] Measured when flying forward at a speed of 21.6 kph in a windless environment at sea level, with camera parameters set to 1080p/30fps, video mode off, and from 100% battery level until 0%. Data is for reference only. Always pay attention to reminders on the goggles' screens during your flight.
- [3] Measured when hovering in a windless environment at sea level, with camera parameters set to 1080p/30fps, video mode off, and from 100% battery level until 0%. Data is for reference only. Always pay attention to reminders on the goggles' screens during your flight.
- [4] Measured when flying forward at a speed of 43.2 kph in a windless environment at sea level, with camera parameters set to 1080p/30fps, video mode off, and from 100% battery level until 0%. Data is for reference only. Always pay attention to reminders on the goggles' screens during your flight.
- [5] Measured in an unobstructed outdoor environment free of interference. The above data shows the farthest communication range for one-way, non-return flights under each standard. Always pay attention to RTH reminders on the goggles screen during your flight.
- [6] Data tested under FCC standard in unobstructed environments with typical interference. Used for reference purposes only and provides no guarantee for actual transmission distance.
- [7] Data tested under FCC standard in environments with typical low interference. Used for reference purposes only and provides no guarantee for actual transmission distance.

DJI Goggles 3

Model	TKGS3
Weight	Approx. 470 g
Dimensions (L×W×H)	With antennas folded: 170×109×112 mm (L×W×H) With antennas unfolded: 205×109×112 mm (L×W×H)
Screen Size (single screen)	0.49 inch
Resolution (single screen)	1920×1080
Refresh Rate	Up to 100 Hz
Interpupillary Distance Range	56-72 mm
Diopter Adjustment Range	-6.0 D to +2.0 D
FOV (single screen)	44°
Video Recording Format	MOV
Supported Video and Audio Playback Formats	MP4, MOV (video coding formats: H.264, H.265; audio formats: AAC, PCM) Panoramic Video: Spherical 2D panoramic videos. 3D Video: Half-Side-by-Side (HSBS), Full-Side-by-Side (FSBS), Half Over-Under (HOU), Full Over-Under (FOU). Max Video Specification: 4K/60fps
Real View Display	1080p/60fps
Operating Temperature	-10° to 40° C (14° to 104° F)
Power Input	Built-in battery
Supported SD Cards	microSD (up to 512 GB)
Recommended microSD Cards	Sandisk Extreme Pro 32GB U3 A1 V30 microSDHC Lexar 1066x 64GB U3 A2 V30 microSDXC Lexar 1066x 128GB U3 A2 V30 microSDXC Lexar 1066x 256GB U3 A2 V30 microSDXC Lexar 1066x 512GB U3 A2 V30 microSDXC Kingston Canvas Go! Plus 64GB U3 A2 V30 microSDXC Kingston Canvas Go! Plus 128GB U3 A2 V30 microSDXC Kingston Canvas React Plus 64GB U3 A1 V90 microSDXC Kingston Canvas React Plus 128GB U3 A1 V90 microSDXC Kingston Canvas React Plus 256GB U3 A1 V90 microSDXC Samsung EVO Plus 512GB U3 A2 V30 microSDXC

Video Transmission

Video Transmission	When used with different aircrafts, the goggles will automatically select the corresponding firmware to match the video transmission specification of the aircraft. With DJI Avata 2: DJI O4
Operating Frequency ^[1]	2.4000-2.4835 GHz 5.170-5.250 GHz 5.725-5.850 GHz
Transmitter Power (EIRP)	2.4 GHz: <33 dBm (FCC), <20 dBm (CE/SRRC/MIC) 5.1 GHz: <23 dBm (CE) 5.8 GHz: <33 dBm (FCC), <30 dBm (SRRC), <14 dBm (CE)
Latency ^[2]	With DJI Avata 2: 1080p/100fps video transmission quality: latency down to 24 ms 1080p/60fps video transmission quality: latency down to 40 ms
Max Transmission Distance	When used with DJI Avata 2, DJI Goggles 3 can achieve the following max video transmission distance: 13 km (FCC), 10 km (CE/SRRC/MIC)
Max Video Bitrate ^[3]	60Mbps

Wi-Fi

Protocol	802.11a/b/g/n/ac
Operating Frequency ^[1]	2.4000-2.4835 GHz 5.170-5.250 GHz 5.725-5.850 GHz
Transmitter Power (EIRP)	2.4 GHz: <20 dBm (FCC/CE/SRRC/MIC) 5.1 GHz: <20 dBm (FCC/CE/MIC) 5.8 GHz: <20 dBm (FCC/SRRC), <14 dBm (CE)

Bluetooth

Protocol	Bluetooth 5.0
Operating Frequency	2.4000-2.4835 GHz
Transmitter Power (EIRP)	<10 dBm

GFSK

Operating Frequency	2.4000-2.4835 GHz
Transmitter Power (EIRP)	<26 dBm (FCC), <20 dBm (CE/SRRC/MIC)

Battery

Dimensions	121×65×52.5 mm (L×W×H)
Capacity	3000 mAh
Voltage	5.6-8.4 V
Category	Li-ion

Chemical System	LiNiMnCoO2
Energy	21.6 Wh
Charging Temperature	0° to 50° C (32° to 122° F)
Max Charging Power	20 W (charging when powered off)
Runtime ^[4]	Approx. 3 hours

- [1] Some countries and regions prohibit the use of the 5.1GHz or 5.8GHz frequency band, or both. In some countries and regions, the 5.1GHz frequency is only allowed for indoor use. Before flying, make sure to check and comply with local regulations.
- [2] Measured in an open outdoor environment without interference. Actual data varies with different aircraft models.
- [3] Measured in an outdoor open environment without interference. Actual data varies with the operating environment.
- [4] The 3-hour max operating time was measured at an ambient temperature of 25° C (77° F), screen brightness at 4, connected to the DJI Avata 2 aircraft, video transmission set to 1080p/100fps, Head Tracking off, Real View off, and the goggles fully charged and not supplying power to external devices such as smartphones.

DJI RC Motion 3

Model	TKMO3
Weight	Approx. 118 g
Operating Frequency	2.4000-2.4835 GHz
Transmitter Power (EIRP)	2.4000-2.4835 GHz: <26 dBm (FCC), <20 dBm (CE/SRRC/MIC)
Max Transmission Distance (unobstructed, free of interference) ^[1]	With DJI Avata 2 and DJI Goggles 3: FCC: 13 km CE/SRRC/MIC: 10 km
Operating Temperature	-10° to 40° C (14° to 104° F)
Operating Time	Approx. 10 hours* * Measured with an ambient temperature of 25° C (77° F), when connected to DJI Avata 2, and in a stationary state.

Battery

Charging Temperature	0° to 50° C (32° to 122° F)
Charging Time	Approx. 2 hours
Charging Type	5 V, 2 A
Battery Capacity	2600 mAh

[1] Measured in an unobstructed outdoor environment free of interference. The above data shows the farthest communication range for one-way, non-return flights under each standard. Always pay attention to RTH reminders on the goggles screen during your flight.

Compatible Products

Visit the following link to view compatible products:

<https://www.dji.com/avata-2/faq>

Updating Firmware

Use one of the following methods to update the firmware:

1. Use the DJI Fly App to update the firmware for the entire set of devices including the aircraft, goggles, and remote control device.
2. Use DJI Assistant 2 (Consumer Drones Series) to update the firmware for a single device.

Using DJI Fly

Power on the aircraft, goggles, and remote control device. Make sure all the devices are linked. Connect the USB-C port of the goggles to the mobile device, run DJI Fly, and follow the prompt to update. An internet connection is required.

Using DJI Assistant 2 (Consumer Drones Series)

1. Power on the device. Connect the device to a computer with a USB-C cable.
2. Launch DJI Assistant 2 (Consumer Drones Series) and log in with your DJI account.
3. Select the device and click Firmware Update on the left side of the screen.
4. Select and confirm the firmware version to update to.
5. Wait for the firmware to download. The firmware update will start automatically.
6. The device will restart automatically after the firmware update is complete.



- If there are any additional batteries that need to be updated, insert the battery into the aircraft and power on the aircraft. A prompt will appear in the goggles to update the battery. Make sure to update the battery before takeoff.
 - Make sure to follow all the steps to update the firmware, otherwise the update may fail.
 - Make sure the computer is connected to the internet during the update.
 - Do not unplug the USB-C cable during an update.
 - The firmware update will take several minutes. During the update process, it is normal for the gimbal to go limp, the aircraft status indicators to blink, and the aircraft to reboot and beep. Wait patiently for the update to complete.
 - Before performing an update, make sure the goggles are at least 20% charged and the remote control device is at least 15% charged.
 - Note that the update may reset various flight parameters, such as the RTH altitude and the maximum flight distance. Before updating, take note of your preferred settings and readjust them after the update.
 - DO NOT use Hardware and Software that is not specified by DJI.
-

Visit the following link and refer to the Release Notes for firmware update information:

<https://www.dji.com/avata-2/downloads>

Maintenance Instructions

To avoid serious injury to children and animals, observe the following rule:

1. Small parts, such as cables and straps, are dangerous if swallowed. Keep all parts out of reach of children and animals.
2. Store the Intelligent Flight Battery and remote controller in a cool, dry place away from direct sunlight to ensure the built-in LiPo battery does NOT overheat. Recommended storage temperature: between 22° and 28° C (71° and 82° F) for storage periods of more than three months. Never store in environments outside the temperature range of 14° to 113° F (-10° to 45° C).
3. DO NOT allow the camera to come into contact with or become immersed in water or other liquids. If it gets wet, wipe dry with a soft, absorbent cloth. Turning on an aircraft that has fallen in water may cause permanent component damage. DO NOT use substances containing alcohol, benzene, thinners, or other flammable substances to clean or maintain the camera. DO NOT store the camera in humid or dusty areas.
4. DO NOT connect this product to any USB interface older than version 3.0. DO NOT connect this product to any "power USB" or similar devices.
5. Check every aircraft part after any crash or serious impact. If there are any problems or questions, contact a DJI authorized dealer.
6. Regularly check the Battery Level Indicators to see the current battery level and overall battery life. The battery is rated for 200 cycles. It is not recommended to continue use afterward.
7. After-Flight Checklist
 - a. Make sure the Intelligent Flight Battery and the propellers are in good condition.
 - b. Make sure that the camera lens and Vision System sensors are clean.
 - c. Make sure to attach the gimbal protector before storing or transporting the aircraft.
8. Make sure to transport the aircraft with the arms folded when powered off.
9. Make sure to transport the remote controller with antennas folded when powered off.
10. The battery will enter sleep mode after long-term storage. Charge the battery to exit from sleep mode.
11. Use the ND filter if the exposure time needs to be prolonged. Refer to the product information on how to install the ND filters.
12. Store the aircraft, remote controller, battery, and charger in a dry environment.
13. Remove the battery before servicing the aircraft (e.g., cleaning or attaching and detaching the propellers). Make sure that the aircraft and the propellers are clean by removing any dirt or dust with a soft cloth. Do not clean the aircraft with a wet cloth or use a cleanser that contains alcohol. Liquids can penetrate the aircraft housing, which can cause a short circuit and destroy the electronics.
14. Make sure to turn off the battery to replace or to check the propellers.

Troubleshooting Procedures

1. Why can the battery not be used before the first flight?
The battery must be activated by charging before using it for the first time.
2. How to solve the gimbal drift issue during flight?
Calibrate IMU and compass in DJI Fly. If the problem persists, contact DJI Support.
3. No function
Check if the Intelligent Flight battery and the remote controller are activated by charging. If the problems persist, contact DJI support.
4. Power-on and start-up problems
Check if the battery has power. If yes, contact DJI support if it cannot be started normally.
5. SW update issues
Follow the instructions in the user manual to update the firmware. If the firmware update fails, restart all the devices and try again. If the problem persists, contact DJI support.
6. Procedures to reset to factory default or last known working configuration
Open the goggles menu and select Settings > About > Reset to Factory Default.
7. Shutdown and power-off problems
Contact DJI support.
8. How to detect careless handling or storage in unsafe conditions
Contact DJI support.
9. How to restore use after long-term storage?
Fully charge the device first and then it can be used normally.

Risk and Warnings

DJI Avata 2

When the aircraft detects a risk after powering on, there will be a warning prompt on DJI Fly.

Pay attention to the list of situations below.

1. If the location is not suitable for takeoff.
2. If an obstacle is detected during flight.
3. If the location is not suitable for landing.
4. If the compass and IMU experience interference and need to be calibrated.
5. Follow the on-screen instructions when prompted.

DJI Goggles 3

When the aircraft detects any risk after powering on, there will be a warning prompt on the goggles screen. Pay attention to the prompt during flight and take necessary actions accordingly

to avoid product damage or risk of injury.

If the Signal Lost Action of the aircraft is set to RTH, when the control signal or transmission is lost during flight, the aircraft will automatically initiate Failsafe RTH and fly back to the last recorded Home Point.

In emergency situations during flight, such as if a collision occurs, a motor stalls, the aircraft rolls in the air, or the aircraft is out of control and is ascending or descending quickly, the motors can be stopped by pressing the motion controller lock button four times.

 • Stopping motors mid-flight will cause the aircraft to crash. Operate with caution.

If the goggles screen goes off unexpectedly during flight, press the motion controller lock button once to brake the aircraft first, and then initiate RTH manually. After the aircraft is back, check the goggles power level and try to restart the goggles. If the problem persists, contact DJI support.

Disposal



Observe the local regulations related to electronic devices when disposing of the aircraft and remote controller.

Battery Disposal

Dispose of the batteries in specific recycling containers only after a complete discharge. DO NOT dispose of the batteries in regular trash containers. Strictly follow the local regulations regarding the disposal and recycling of batteries.

Dispose of a battery immediately if it cannot be powered on after over-discharging.

If the power on/off button on the Intelligent Flight Battery is disabled and the battery cannot be fully discharged, contact a professional battery disposal/recycling agency for further assistance.

C1 Certification

DJI Avata 2 is comply with C1 certification, there are some requirements and restrictions when using DJI Avata 2 in European Economic Area (EEA, i.e. EU plus Norway, Iceland and Liechtenstein).

UAS Class	C1
Sound Power Level	81 dB
Maximum Propeller Speed	51430 RPM

MTOM Statement

The MTOM of DJI Avata 2 (Model QF3W4K), including the SD card, is 377 g to comply with C1 requirements.

Users must follow the instructions below to comply with the MTOM C1 requirements.

Otherwise, the aircraft cannot be used as a C1 UAV:

- DO NOT add any payload to the aircraft, such as the propeller guards, etc.
- DO NOT use any non-qualified replacement parts, such as intelligent flight batteries or propellers, etc.
- DO NOT retrofit the aircraft.

-
-  • The prompt "Low Battery RTH" will not appear in case of a horizontal distance between the pilot and aircraft is lower than 5 m.
- The auxiliary LED is set to auto when used in the EU and cannot be changed. The aircraft Front Arm LEDs are always on when used in the EU and cannot be changed.
-

Direct Remote ID

1. Transport Method: Wi-Fi Beacon
2. Method of uploading the UAS Operator Registration Number to the aircraft:
 - a. Connect the goggles to the mobile device.
 - b. Launch DJI Fly on the mobile device.
 - c. Enter DJI Fly > System Settings > Safety > UAS Remote Identification, and then upload UAS Operator Registration Number.

Low Blue Light Statement

Light from displays can cause eyestrain and retina damage which can affect vision over time. DJI Goggles 3 adopts micro-OLED eye-protection screens, which can effectively reduce the high-energy shortwave blue light and its emission range, therefore protecting users from exposure to harmful blue light. DJI Goggles 3 has obtained the Low Blue Light certification.

It is highly recommended to follow the instructions below to protect your eyes against prolonged display use:

- Look away from the screen and then at a distant place for 20 seconds every 20 minutes.
- Rest your eyes for 10 minutes after 2 hours of continuous use.

- Roll your eyes upward and then in a large circle every few hours.
- When your eyes get tired, try to blink at a normal rate, then close your eyes and rest for a minute.

List of Items, including qualified accessories

1. DJI Avata 2 Propellers (Pair) (Model: 3032S, 3.4g)
2. DJI Avata 2 ND Filters Set (ND 8/16/32) (2.1 g)
3. DJI Avata 2 Intelligent Flight Battery (Model: BWX520-2150-17.76, Approx. 145 g)
4. MicroSD Card (Approx. 0.3 g)

List of Spare and Replacement Parts

1. DJI Avata 2 Propellers (Model: 3032S)
2. DJI Avata 2 Intelligent Flight Battery (Model: BWX520-2150-17.76, Approx. 145 g)

GEO Awareness

Drone Geo-Zones UGZ Zone and DJI Geo Zone

DJI is committed to maintaining a safe flying environment. This includes abiding by local regulations and Unmanned Geographical Zones (UGZs) defined by EU national authorities. DJI has its own Geospatial Environment Online system (GEO) with broader geographical zones, including regulated areas where flight may raise concerns. DJI's GEO system has been running successfully for many years, effectively protecting flight safety and public safety in the absence of official UGZ databases.

In the future, DJI Geo zones will coexist with EU UGZs, as UGZs are still not available in many countries. Users are responsible for checking local regulations and for any flight restrictions where they intend to operate.

The GEO zones mentioned in the manual and DJI official website refers to the DJI Geo zones and Geo fencing function, not the UGZs for Geo awareness function required by regulations.

GEO Awareness contains the features listed below.

UGZ (Unmanned Geographical Zone) Data update: user can update the FlySafe data by using the data update feature automatically or storing the data in the aircraft manually.

- Method 1: Go to Settings in DJI Fly, tap About > FlySafe Data, tap Check for Updates to update the FlySafe data automatically.
- Method 2: Check on website of your national aviation authority regularly and obtain latest UGZ data to import to your aircraft. Go to Settings in DJI Fly, tap About > FlySafe Data, tap Import from Files, and then follow the on-screen instructions to store and import the UGZ data manually.

Note: A prompt will appear in the DJI Fly app when the import completes successfully. If the import fails due to improper data format, follow the on-screen prompt and retry.

GEO Awareness Map Drawing: after the latest UGZ data is updated, a flight map with a restricted zone will be displayed in the DJI Fly app. Name, effective time, height limit, etc., can be viewed by tapping the area.

GEO Awareness Pre-Warning: the app will prompt the user with warning information when the aircraft is near or in a restricted area, the horizontal distance is less than 160 m, or the vertical distance is less than 40 m from the zone to remind the user to fly with caution.

- ⚠ Before takeoff, users must download the latest GEO Zone data from the official aviation regulation website of the country or region where the aircraft is being used. It is the responsibility of the user to make sure that the GEO zone data is the latest version and that it is applied to every flight.

AGL (Above Ground Level) Statement

The vertical part of "Geo-awareness" may use the AMSL altitude or the AGL height. The choice between these two references is specified individually for each UGZ. Neither AMSL altitude nor the AGL height is supported by DJI Avata 2. The height H appears in the DJI Fly app camera view, which is the height from the aircraft takeoff point to the aircraft. The height above the takeoff point may be used as an approximation but may differ more or less from the given altitude/height for a specific UGZ. The remote pilot remains responsible for not breaching the vertical limits of the UGZ.

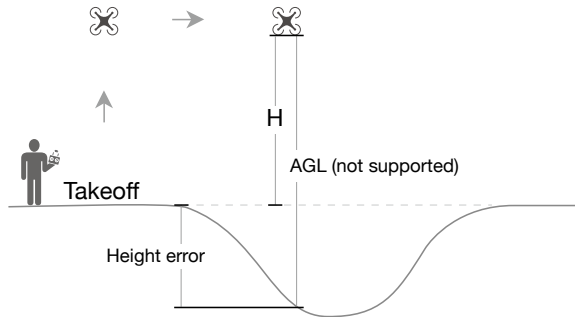

Restricted Zones

Appear red in the DJI app. Users will be prompted with a warning, and flight is prevented. UA cannot fly or takeoff in these zones. Restricted Zones may be unlocked, to unlock contact flysafe@dji.com or go to [Unlock A Zone at dji.com/flysafe](https://dji.com/flysafe).

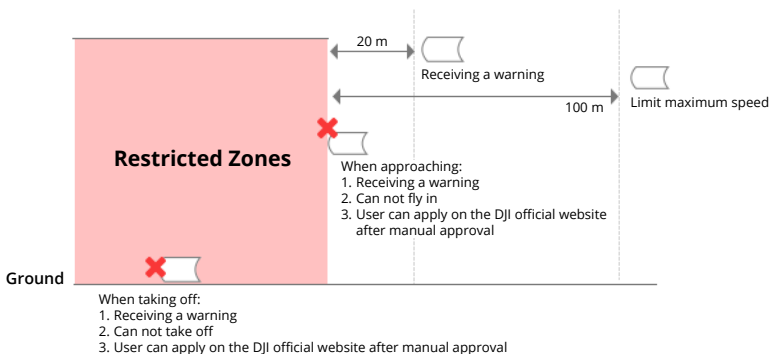

Authorization Zones

Appear blue in the DJI app. Users will be prompted with a warning, and flight is limited by default. UA cannot fly or take off in these zones unless authorized. Authorization Zones may be unlocked by authorized users using a DJI verified account.

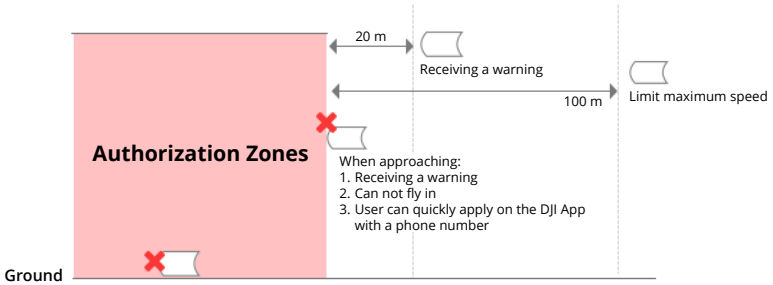

Altitude Zones

Altitude zones are zones with a limited altitude and appear in gray on the map. When approaching, users receive warnings in the DJI app.

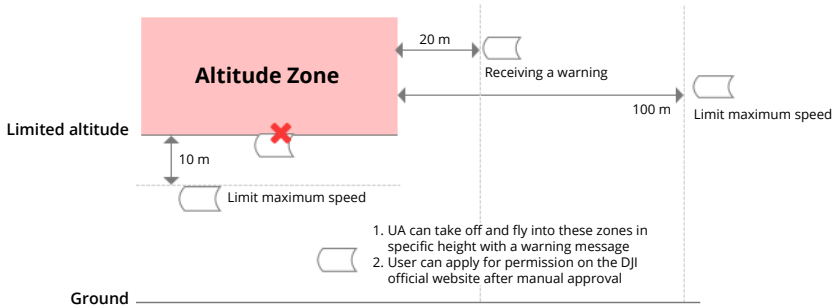

Enhanced Warning Zones

A warning message will prompt users when the drone reaches the edge of the zone.



 • When the aircraft and DJI Fly app cannot obtain a GPS signal, the GEO awareness function will be inoperative. Interference of the aircraft antenna or disabling the GPS authorization in DJI Fly will cause the GPS signal fails to be obtained.

Warning Zones

A warning message will prompt users when the drone reaches the edge of the zone.

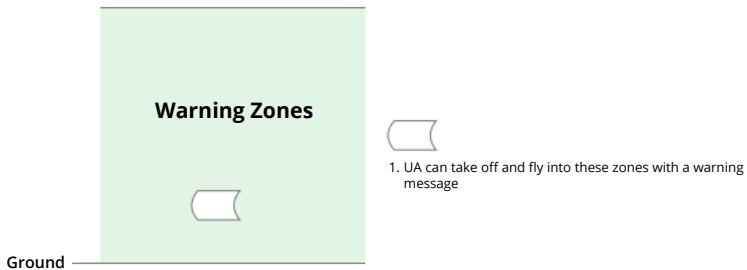

EASA Notice

Make sure to read the Drone Information Notices document included in the package before use. Visit the link below for more EASA notice information on traceability.

<https://www.easa.europa.eu/en/document-library/general-publications/drones-informationnotices>

Original Instructions

This manual is provided by SZ DJI TECHNOLOGY CO., LTD., and the content is subject to change. Address: Lobby of T2, DJI Sky City, No. 53 Xianyuan Road, Xili Community, Xili Street, Nanshan District, Shenzhen, China.

FAR Remote ID Compliance Information

The unmanned aircraft system is equipped with a Remote ID system that meets the requirements of 14 CFR Part 89.

The aircraft automatically broadcasts Remote ID messages from takeoff to shut down. An external device such as a cell phone or tablet is required to be connected as a location source to DJI mobile devices without an integrated GNSS system ^[1], and must run the DJI flight control app such as DJI Fly in the foreground and always allow the DJI flight control app to obtain its accurate location information. The connected external device must minimally be one of the following:

- 1) FCC Certified personal wireless device that uses GPS with SBAS (WAAS) for location services; or
- 2) FCC Certified personal wireless device with integrated GNSS.

Also, the external device must be operated in a way that does not interfere with the location reported and its correlation to the operator location.

- The aircraft automatically initiates a pre-flight self-test (PFST) of the Remote ID system before takeoff and cannot take off if it does not pass the PFST ^[2]. The results of the PFST of the Remote ID system can be viewed in either a DJI flight control app such as DJI Fly or DJI goggles.
- The aircraft monitors the Remote ID system functionality from pre-flight to shut down. If the Remote ID system malfunctions or has a failure, an alarm will be displayed in either a DJI flight control app such as DJI Fly or DJI goggles.
- You can visit the official website of FAA to learn more about aircraft registration and Remote ID requirements.

Footnotes

- [1] DJI mobile devices without an integrated GNSS system such as DJI RC Motion 3, DJI FPV Remote Controller 3.
- [2] The pass criterion for PFST is that the hardware and software of the Remote ID required-data source and transmitter radio in the Remote ID system are functioning properly.

Flight Data

Flight data including flight telemetry, aircraft status information, and other parameters are automatically saved to the internal data recorder of the aircraft. The data can be accessed using DJI Assistant 2 (Consumer Drones Series).

Aftersales Information

Visit <https://www.dji.com/support> to learn more about aftersales service policies, repair services, and support.

Maintenance

Replacing the Foam Padding for Goggles

1. Hold the bottom of the foam padding and remove it gently, as shown below.

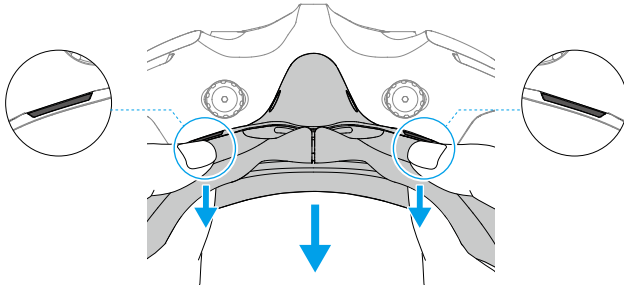

- DO NOT pull the sides when removing the foam padding. Otherwise, the padding may be damaged.

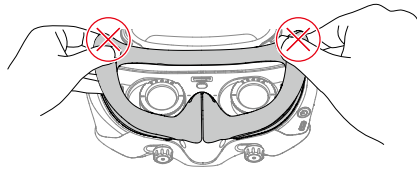

2. Align the positioning columns of the new foam padding with the positioning holes on the goggles. Install it and press along the contour. You will hear a "click" sound when pressing the two sides of the foam padding, check and make sure that there is no gap between the foam padding and the goggles.

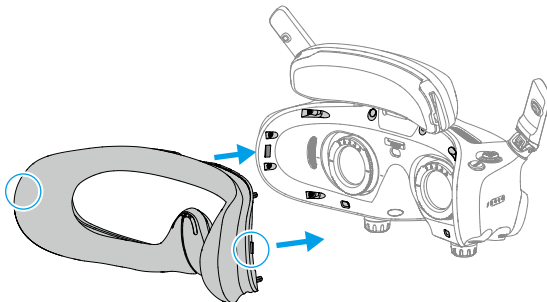

Cleaning and Maintenance of the Goggles

Clean the surface of the goggles with a soft, dry, clean cloth. Use the lens cleaning cloth to clean the lenses in a circular motion from the center to the outer edges.



- DO NOT clean the integrated goggle lenses with alcohol wipes. The installed corrective lenses can be cleaned with disposable alcohol pads.
 - Clean the lenses gently. DO NOT scratch them as this will affect viewing quality.
 - DO NOT use alcohol or other cleanser to wipe the foam padding and the soft side of the battery compartment.
 - DO NOT tear or scratch the foam padding, the additional forehead pad, and the soft side of the battery compartment with sharp objects.
 - Store the goggles in a dry place at room temperature to avoid damage to the lenses and other optical components from high temperatures and humid environments.
 - Keep the lenses away from direct sunlight to avoid screen damage.
-

WE ARE HERE FOR YOU



Contact
DJI SUPPORT

This content is subject to change.



<https://www.dji.com/avata-2/downloads>

If you have any questions about this document, please contact DJI by sending a message to DocSupport@dji.com.

DJI and DJI AVATA are trademarks of DJI.
Copyright © 2024 DJI All Rights Reserved.