



# 4 - CHANNEL QUADCOPTER

Product code: EACHINE 3D X4

## INSTRUCTION MANUAL



### Orientation mode

#### 1. Main Features

1. 4 motors driven, leading to steady flight and rolling
2. Easily install and fix
3. Adopt 6-gyro, one key 3D flip. Easy control, better flight

## 2. Parts of the Quadcopter

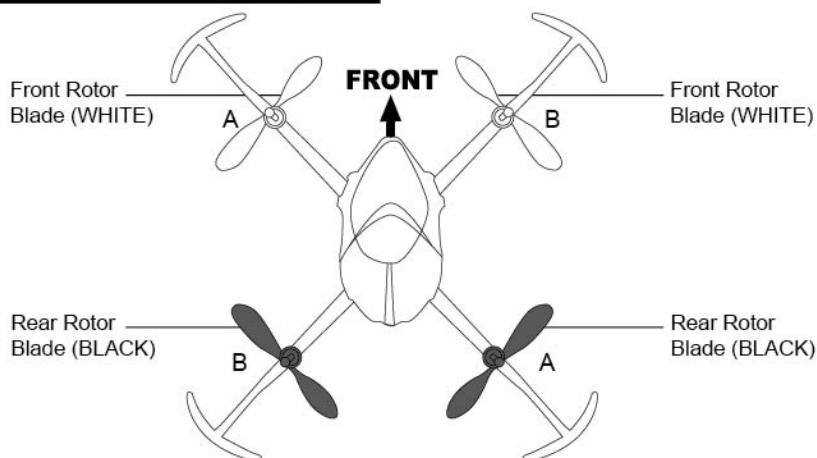

## 3. Parts of the Transmitter

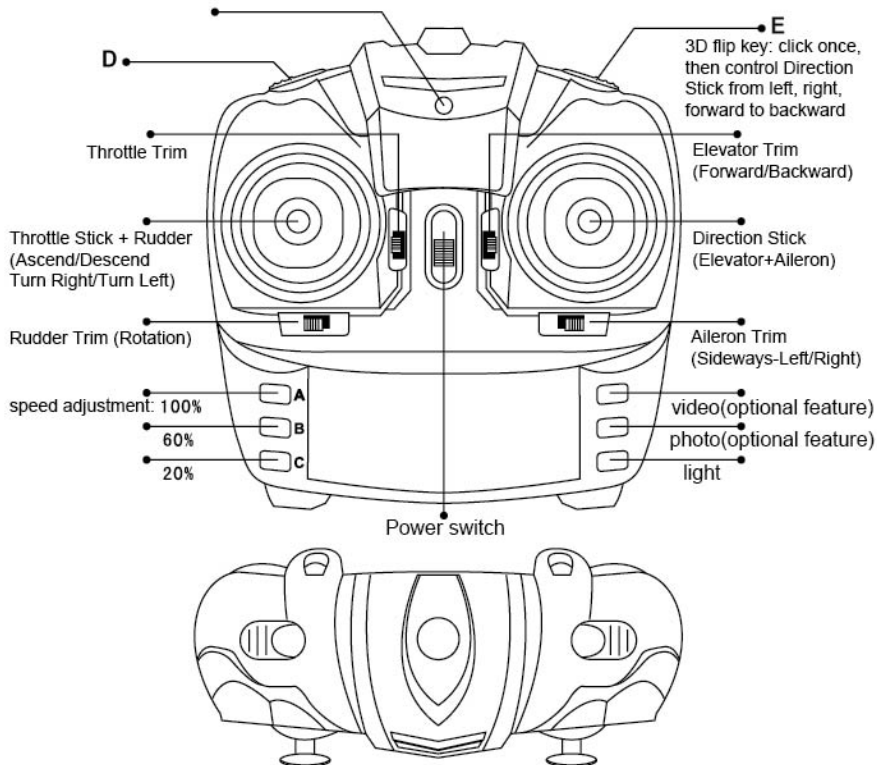

#### **4. Safety Precautions**

1. Please read these Instructions carefully and follow them when operating the Quadcopter.
2. Fly the quadcopter within your line of vision for easier control.
3. Never fly the quadcopter in crowded areas, near to toward people or animals, to prevent property damage and/or personal injury.
4. Do not attempt to modify the product.
5. Keep small elements of the product away from small children, to avoid CHOKING accidents.
6. Keep at least 1-2 meters distance from the quadcopter when it is flying, to avoid injury.
7. Do not dispose the batteries in the heat (fire, electronic heating device, etc.).
8. Do not dispose the quadcopter in wet ( rain, moisture, dust, fog etc.) to avoid the parts malfunction.
9. Parental guidance is highly recommended.

#### **5. Preparation to Fly**

1. This quadcopter is designed for Outdoor, Indoor flight. However it is important to note the recommended conditions and flying environment.  
Choose a place with a minimum of potentially hazardous obstacles.  
Recommended minimum flying area: 8m x 8m x 4m
2. Make sure the batteries of the quadcopter and transmitter are fully charged.
3. Turn the transmitter "OFF". Push the Throttle Stick downwards to the minimum position. Place the transmitter close to the quadcopter.
4. Connect the charged Li-PO battery to the PCB. LEDs start to flicker. Do Not Move the quadcopter after this point. Switch "ON" the transmitter. The binding process is on.
5. Check carefully the batteries and motors. Make sure all in condition.
6. Recommended condition to Flip: battery voltage at 3.8V~4V.

## 6. Installing Transmitter Batteries

1. Slide open the Battery Compartment Lid
2. Insert 4 AA batteries, in the Polarity direction indicated. Do not mix battery types. (Batteries not included)
3. Close Battery Compartment Lid.

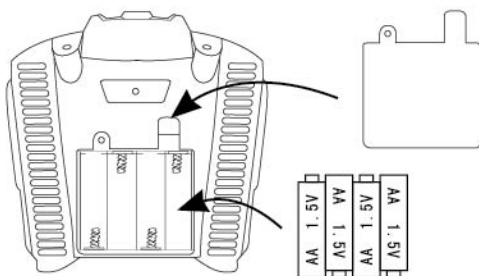

## 7. Charging the Quadcopter Li-PO Battery

1. Connect Li-PO Battery to the USB charger.
2. RED LED on USB indicates charging is complete. RED LED off indicates charging is in progress.

REMARK: the USB in pack only can use in this quadcopter.

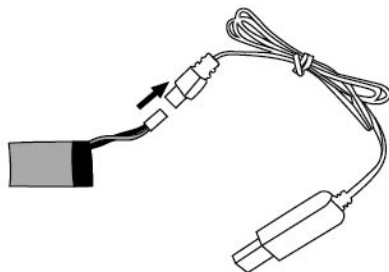

## 8. Binding the Quad Receiver with the Remote

1. Turn the Transmitter "OFF". Push the Throttle Stick downward to the minimum position. Place the Transmitter close to the Quadcopter.
2. Turn the Quadcopter upside down. The Main PCB is now visible, facing upwards.
3. Push the Battery into the enclosure under the PCB. Connect the charged Li-PO battery to the PCB.
4. Place the Quadcopter on a FLAT surface. WHITE LED starts to flicker. Do Not Move the Quadcopter after this point!
5. Switch "ON" the transmitter. The RED LED in the centre of the Transmitter blinks rapidly, indicating the binding process is on.
6. When the RED LED on the PCB and the LED in the transmitter remain constant, the binding process is complete. Push the Throttle Stick to the maximum position then to minimum position.
7. When the Li-Po battery lacking power, the WHITE LED will flicker until landing.

**IMPORTANT: Do Not Move the Quadcopter while the Binding process is on, as the Gyro is being Set to Neutral!**

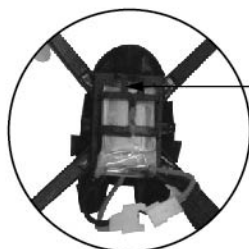

battery pack

battery installation instruction



connect the battery with PCB, binding.

## 9. Important Information

1. If the quadcopter moves sideways, using the transmitter to trim adjustment. Push the Throttle Stick to lower right corner until the WHITE LED of the quadcopter flickers. It is same with the Aileron Trim on the transmitter. Recommended voltage while trimming is above 4.0V.
2. Orientation Mode Operation  
Press the Orientation Mode key for once, after sounding Dee Dee Dee, and then it set.
3. Switch OFF the transmitter or no control for 50 seconds, the Quadcopter will be Auto Sleep.

## 10. Setting Quadcopter Response

The 3 Response buttons on the Remote are used to change the percentage of response of the Quadcopter.

C: 20% = Least Response (For Beginners)

B: 60% = Press to raise the level to 60% (For Skillful)

A: 100% = Press to 100%. Highest Response (For Expert Fliers)

## 11. 3D Flight Techniques

Rolls and flips are advanced flying techniques and should be attempted once you have mastered the art of controlling the quadcopter in flight. The speed should be in 100%.

1. Select an open space OUTDOORS, clear of obstacles and away from bystanders.
2. With the Quadcopter hovering steadily (3m above the ground), click the "Orientation Mode" (D) button on the left side of the Transmitter with your index finger. Then click the "ROLL" button (E) on the Right side of the Transmitter with your index finger. Push the Stick to Forward, Backward, Left or Right, the quadcopter will 3D Flip. (For Skillful Fliers)

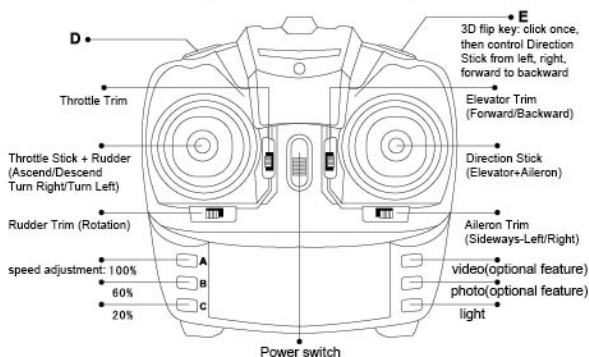

## 12. Receiver Board Instruction

The Receiver installation should as below pic, otherwise can not work normally.

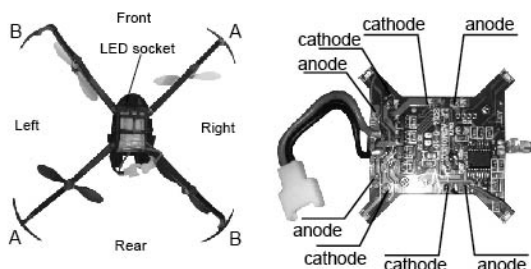

## FLIGHT CONTROL

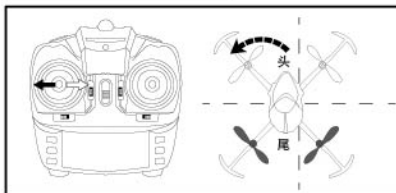

1. When the joystick to the left movement around, Aircraft flying to the left.

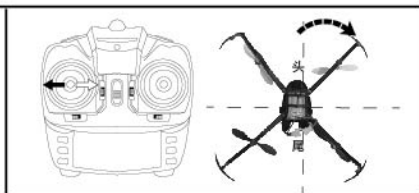

2. When the joystick to the left movement around, Aircraft synchronous inverted to the right.

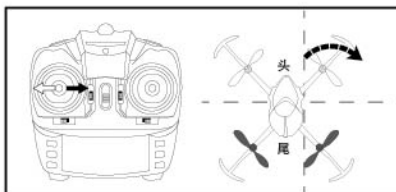

3. When the joystick around right action, Aircraft flying to the right.

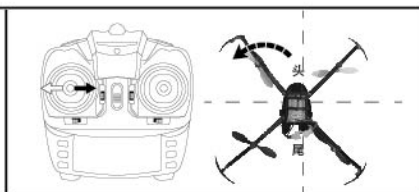

4. When the joystick around right action, Aircraft synchronous inverted to the left.

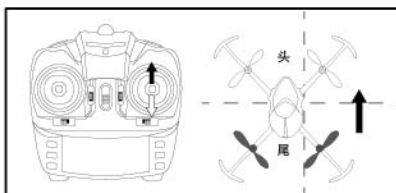

5. When the throttle lever upward movement, Aircraft flying forward.

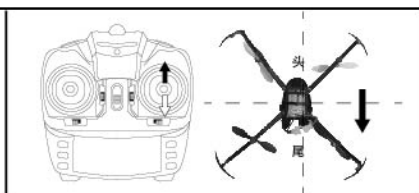

6. When the throttle lever upward movement, After the aircraft flying inverted.

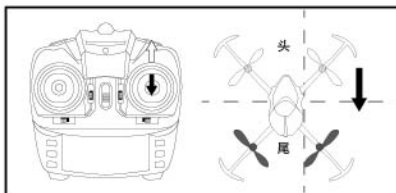

7. When the throttle lever moves down, Aircraft flying back.

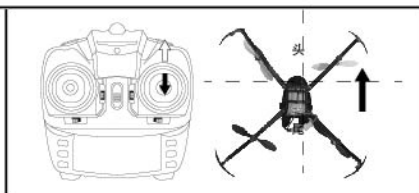

8. When the throttle lever moves down, Aircraft flying forward inverted.

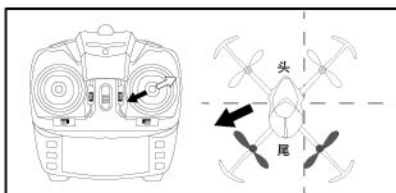

9. When the left joystick (throttle) left, aircraft The fuselage tilted to the left, the aircraft to fly to the left.

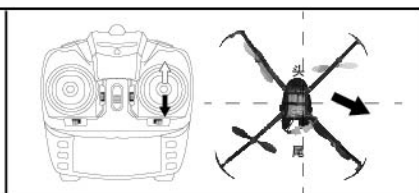

10. When the left joystick (throttle) left, aircraft The fuselage tilted to the left, flying of the aircraft to the right.

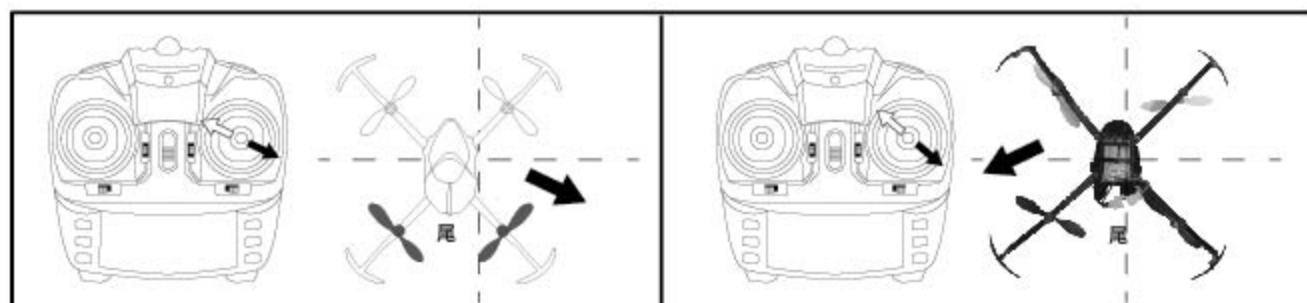

11. When the left joystick (gas) to the right push, aircraft Fuselage tilted to the right, to the right side of the aircraft is flying.

12. When the left joystick (gas) to the right push, aircraft The fuselage tilted to the left, the aircraft to fly to the left.

### 13. Spare Parts (selective purchasing)

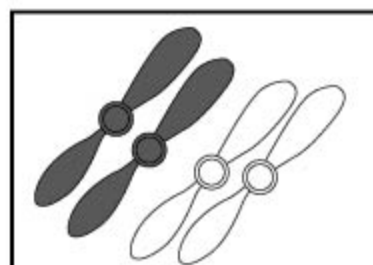

3D X4-01  
blades

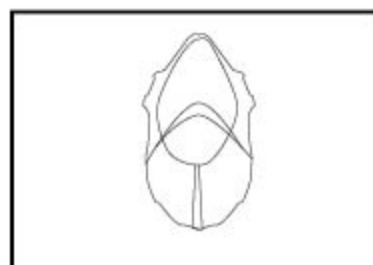

3D X4-02  
canopy

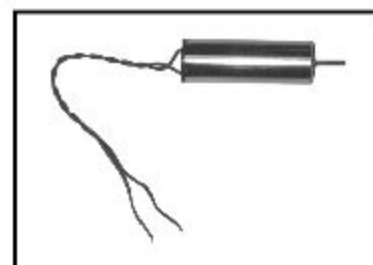

3D X4-03  
Forward motor  
components

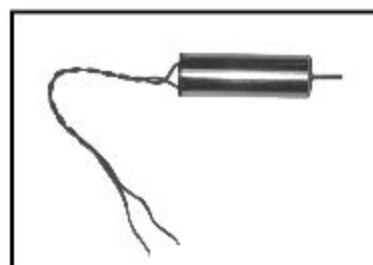

3D X4-04  
Inversion motor  
components

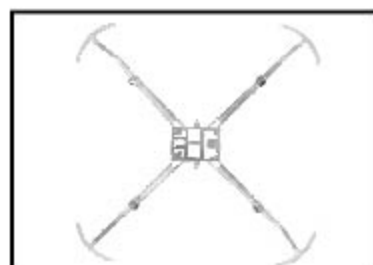

3D X4-05  
main frame



3D X4-06  
receiver



3D X4-07  
USB

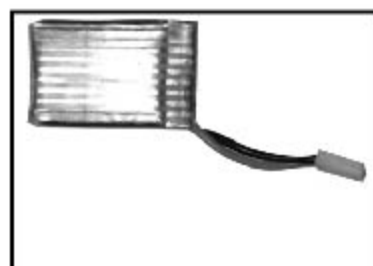

3D X4-08  
battery

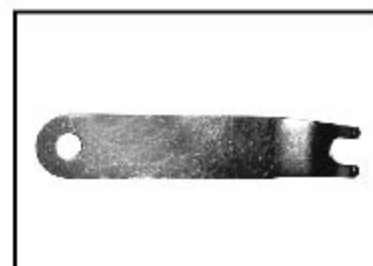

3D X4-09  
blade plier