



QX105 **BAT**

MICRO FPV RACING DRONES

QUICK START GUIDE V1.0

1. Specification

Brand Name: Eachine

Size: 112mm*106mm*43mm

Weight: 56.5g (Without battery)

Flight controller: Eachine AIOF3PRO_Brushed built-in OSD

Motor: Coreless 1020 Black Edition CW/CCW

Propeller: 2611 66mm CW/CCW 2-blades propeller

Camera: 600TVL HD CMOS 1/4inch

VTX: 5.8g 25MW 48CH NTSC/PAL Video transmitter

Battery: 3.7V 600mah Lipo battery

OSD: Betaflight OSD

Firmware of Flight controller :Betaflight 3.0.1 (Target:OmnibusF3)

Flight time : 5 minutes (Battery voltage at 2.8v)

Receiver Option:

-Frsky D8 mode SBUS Output 8ch With RSSI output

-Flysky compatible 8ch PPM receiver (AFHDS 2A Mode)

-DSM2/DSMX compatible Receiver

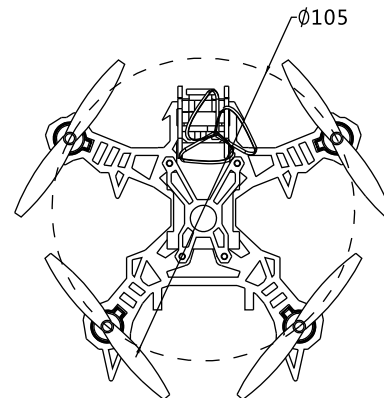
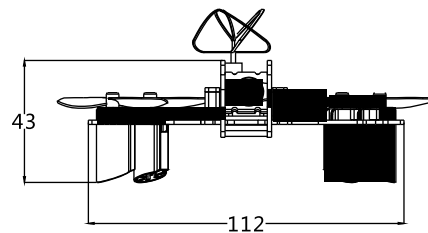

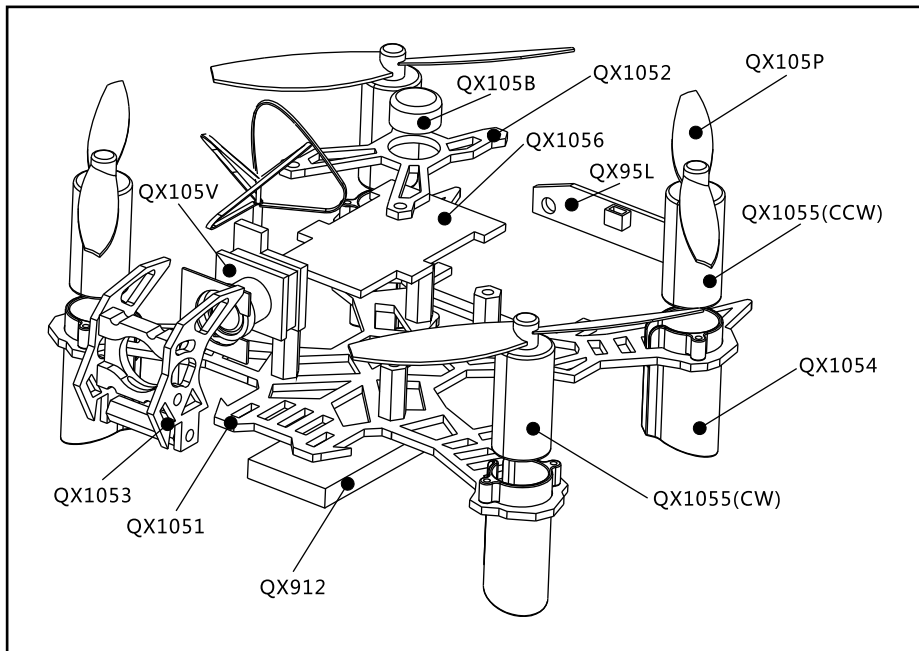

2. Components	QTY	FRSKY	FLYSKY	DSM2/DSMX	Part NO.
1.5mm 3K carbon fiber bottom plate	1	Include	Include	Include	QX1051
1.5mm 3K carbon fiber top board	1	Include	Include	Include	QX1052
CNC Aluminum camera mount	1	Include	Include	Include	Qx1053
1020 Motor mounting seat	4	Include	Include	Include	QX1054
Eachine 1020 Coreless motor (CW)	3	Include	Include	Include	QX1055CW
Eachine 1020 Coreless motor (CCW)	3	Include	Include	Include	QX1055CCW
AIOF3PRO_BRUSHED FC built-in Frsky receiver	1	Include			QX1056
AIOF3PRO_BRUSHED FC built-in Flysky receiver	1		Include		
AIOF3PRO_BRUSHED FC built-in DSM2/X receiver	1			Include	
3IN1 5.8G 48CH VTX&600TVL Camera	1	Include	Include	Include	QX105V
2611 66MM Propeller(2pcs CW+2pcs CCW)	2	Include	Include	Include	QX105P
3.7V 600mah Lipo battery	2	Include	Include	Include	QX912
Charger cable	1	Include	Include	Include	QX913
1S USB Charger	1	Include	Include	Include	QX95C
Propeller Disassembly tool	1	Include	Include	Include	QX914
Rear Ws2812 LED Board	1	Include	Include	Include	QX95L
Buzzer	1	Include	Include	Include	QX105B

3. 5.8G VTX channels list

CH \ FR	FR					
	GA	GB	GC	GD	GE	GF
CH1	5740MHz	5705MHz	5865MHz	5658MHz	5733MHz	5362MHz
CH2	5760MHz	5685MHz	5845MHz	5695MHz	5752MHz	5399MHz
CH3	5780MHz	5665MHz	5825MHz	5732MHz	5771MHz	5436MHz
CH4	5800MHz	5645MHz	5805MHz	5769MHz	5790MHz	5473MHz
CH5	5820MHz	5885MHz	5785MHz	5806MHz	5809MHz	5510MHz
CH6	5840MHz	5905MHz	5765MHz	5843MHz	5828MHz	5547MHz
CH7	5860MHz	5925MHz	5745MHz	5880MHz	5847MHz	5584MHz
CH8	5880MHz	5945MHz	5725MHz	5917MHz	5866MHz	5621MHz

Orange: Camera video signal

Blue: Video out

Red: +5V

Black: GND

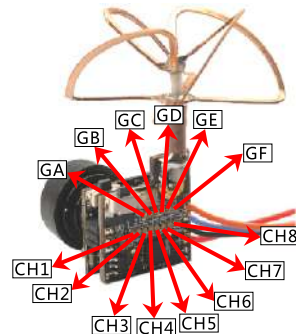

NTSC/PAL Switch
still touch up 2S;
Short touch switch
to reverse video
display

Frequency
group A~F
selected still
touch up to 2S;
Channel ch1~ch8
selected with
short touch.

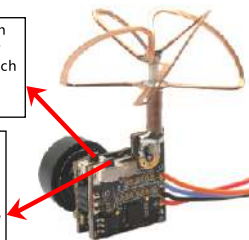

 **CAUTION:** Read and follow all instructions and warnings in the manual prior to setup or use. Failure to operate the product correctly can result in damage to the product, personal property and/or injury. This is a sophisticated hobby product. It must be operated with caution and common-sense and requires some basic mechanical ability.

4. General Product Safety Precautions

- As the user of this product, you are responsible for operating it safely, not endangering yourself and others, or damaging the product or the property of others.
- Operate your product in open spaces away from people and property.
- Never operate your product with damaged electrical components.
- Keep the transmitter powered on while model is powered on.
- Let parts cool after use before touching, motors will get hot in use.
- Remove batteries after use, as applicable.
- Keep all batteries, chemicals, small parts and anything electrical out of the reach of children.
- Avoid water exposure to this product. Keep parts dry.
- Keep moving parts clean.

5. Flight controller connection diagram

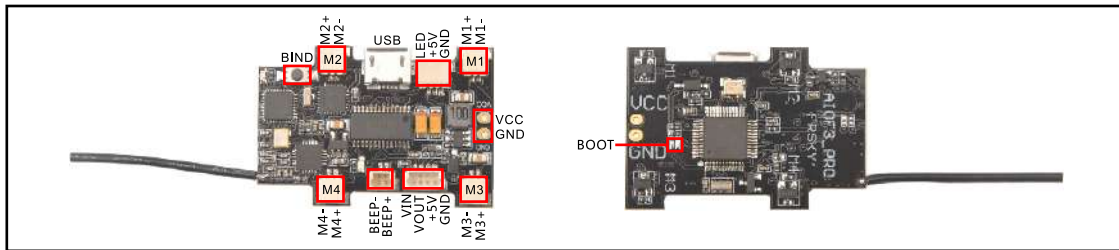

6. Charge the Flight Battery

NOTICE: Inspect the battery to make sure it is not damaged e.g., swollen, bent, broken or punctured. Charge only batteries that are cool to the touch and are not damaged.

Charging with Balance Charger

Connect the 2 batteries and the charge cable ,then connect the cable to 2S Balance charge (Not include) like B3PRO, 3S10D,4S15D, Charsoon DC-4S ,etc.

⚠ CAUTION: Only use 2 batteries together to charging

⚠ CAUTION: Once charging is complete, immediately remove the battery.

Never leave a battery connected to the charger.



Charging with USB Li-Po Charger

Connect the battery to the USB Li-Po Charger,
then plug into the USB port of your computer

LED STATUS:

Solid Red LED --Charging

Solid Blue LED --Charge Complete

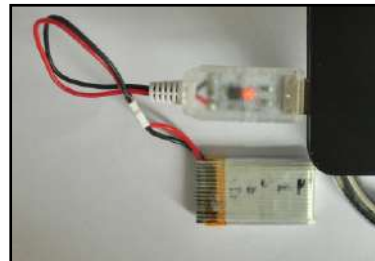

7. QX105 Frsky BNF Version binding procedue



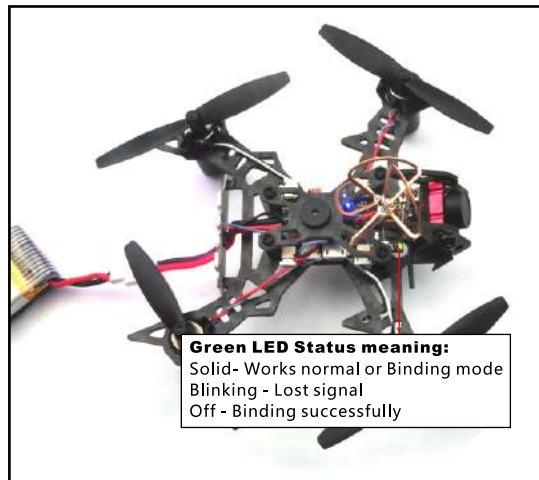





1. Power for the QX105 while holding the Bind button, the Green LED on the receiver will getting to be solid, this means the QX105 is in binding mode, then release the Bind button.



2. Turn on your Radio and select D8 mode for the Receiver. Then Go to the Receiver [Bind] option, and ENT to Binding with the QX105. The Green LED on the receiver will turning off, this indicates binding successfully.

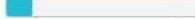

3. The default receiver channel map for QX105 Frsky version is TAER1234, please ensure your transmitter is matched with it, otherwise it can't be armed. And the RSSI output was set CH9 . .

Roll		1500	Channel Map	TAER1234	RSSI Channel	9
Pitch		1500				
Yaw		1500	RC Deadband	0	Yaw Deadband	0
Throttle		885				
AUX 1		1375	RC Interpolation	Auto	RC Interpolation	
AUX 2		1500				
AUX 3		1500				
AUX 4		1500				
AUX 5		1500				

8. Arm/Disarm QX105 Frsky BNF

1. The Default Arm/Disarm switch for QX105 is AUX1(Channel 5),and you can also customize it with Betaflight Configurator. We also set the AUX2(Channel 6) for change flight mode and AU3(Channel 7) for activate the buzzer which you can customize them too .

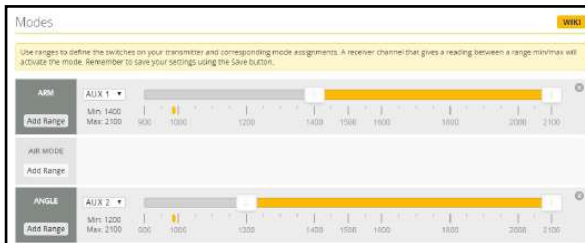

2. Set Arm/Disarm switch for your TARANIS X9D: Move to the MIXER interface, Set "SA" or "SB" switch etc. for Ch5 to ARM/DISARM the motor. Suggest use a 3-steps switch to change flight mode.



3. Toggle the AUX1 Switch, The buzzer starts beeps one time and the Blue LED on the Flight controller will first turning off and get to be solid soon, this indicate the motor was armed. And also you can found "ARMED" shows on your FPV Goggles or the FPV Monitor. Be careful and enjoy your flight now!

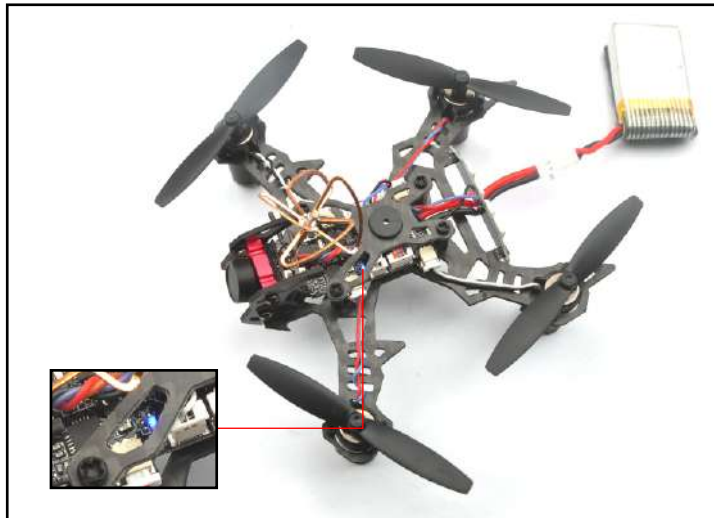

9. QX105 Frsky BNF version receiver configuration

We have configured the frsky receiver for the QX105 before shipping. If you flashed the firmware ,Please setup as the following steps: Enable Serial_RX for UART3, then select RX_SERIAL from the RECEIVER Mode and set the Serial Receiver Provider to be SBUS in Betaflight Configurator.

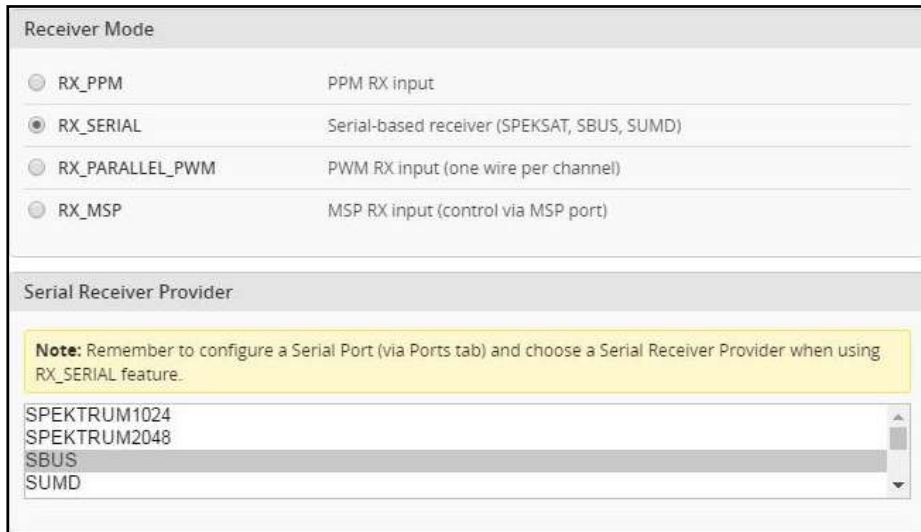

The screenshot shows the 'Receiver Mode' configuration screen in Betaflight Configurator. It features four radio button options: RX_PPM, RX_SERIAL (selected), RX_PARALLEL_PWM, and RX_MSP. Below this is the 'Serial Receiver Provider' section, which includes a yellow note box and a scrollable list of providers: SPEKTRUM1024, SPEKTRUM2048, SBUS (highlighted), and SUMD.

Receiver Mode	
<input type="radio"/> RX_PPM	PPM RX input
<input checked="" type="radio"/> RX_SERIAL	Serial-based receiver (SPEKSAT, SBUS, SUMD)
<input type="radio"/> RX_PARALLEL_PWM	PWM RX input (one wire per channel)
<input type="radio"/> RX_MSP	MSP RX input (control via MSP port)

Note: Remember to configure a Serial Port (via Ports tab) and choose a Serial Receiver Provider when using RX_SERIAL feature.

- SPEKTRUM1024
- SPEKTRUM2048
- SBUS**
- SUMD

10. QX105 Flysky BNF Version binding procedue

1. Power for the QX105 while holding the Bind button, the Green LED on the receiver will getting to be blinking fast, this means the QX105 is in binding mode, then release the Bind button.

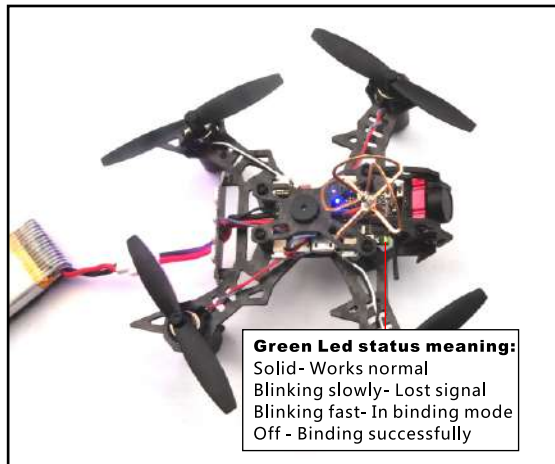

2. Please Ensure the RX setup of your Flysky Radio is in AFHDS 2A Mode. Then Turn on your radio while holding the binding button to Binding with the QX105. The Green LED will turning off for a second and then starting to blinking slowly, this indicates binding successfully. The Green LED is Solid when the connection was established between the QX105 and your Flysky radio.

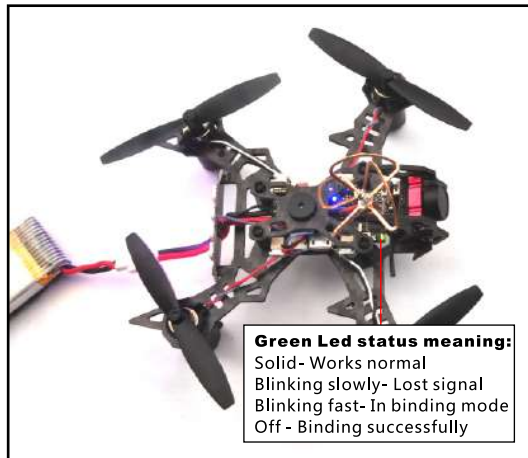

3. The default receiver channel map for QX105 Flysky version is AETR1234, please ensure your transmitter is matched with it, otherwise it can't be armed.

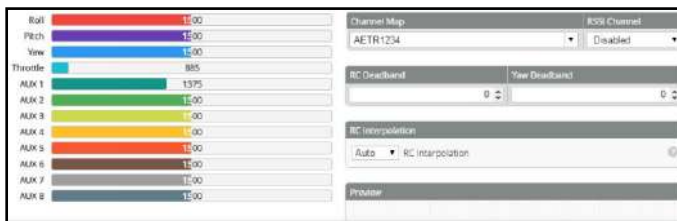

11. Arm/Disarm QX105 Flysky BNF Version

1. The Default Arm/Disarm switch for QX105 is AUX1(Channel 5),and you can also customize it with Betaflight Configurator. We also set the AUX2(Channel 6) for change flight mode and AU3(Channel 7) for activate the buzzer which you can customize them too .

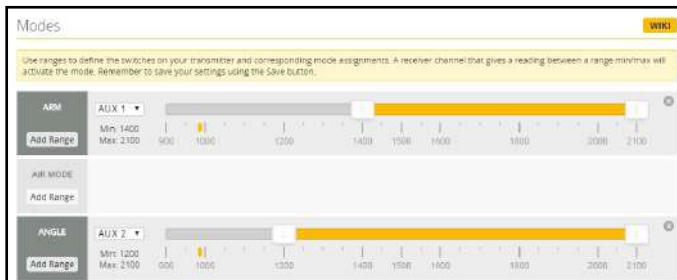

2. Set Arm/Disarm switch for your Flysky Radio: Move to the Aux.channels interface, Set "SWA" or "SWB" or "SWC" switch etc. for Ch5 to ARM/DISARM the motor. Suggest use a 3-steps switch (like "SWC" of the Flysky I6) to change flight mode .



3. Toggle the AUX1 Switch, The buzzer starts beeps one time and the Blue LED on the Flight controller will first turning off and get to be solid soon, this indicate the motor was armed. And also you can found "ARMED" shows on your FPV Goggles or the FPV Monitor. Be careful and enjoy your flight now!

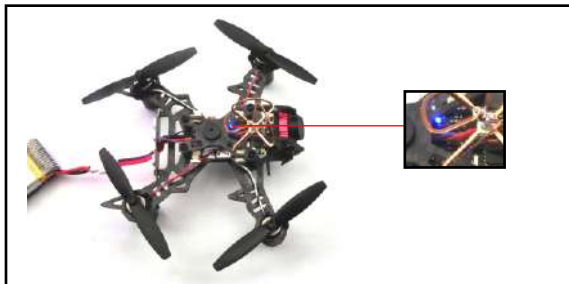

12. QX105 Flysky version receiver configuration

We have configured the flysky receiver for the QX105 before shipping. If you flashed the firmware, Please setup as the following steps: Select RX_PPM from the RECEIVER Mode.

Ports [INFO]

Note: not all combinations are valid. When the flight controller firmware detects this the serial port configuration will be reset.
Note: Do **NOT** disable MSP on the first serial port unless you know what you are doing. You may have to reflash and erase your configuration if you do.

identifier	data	Logging	Telemetry	RX	GPS
USB VCP	<input checked="" type="checkbox"/> MSP 115200 ▾	<input type="checkbox"/> Blackbox 115200 ▾	Disabled ▾ AUTO ▾	<input type="checkbox"/> Serial RX	<input type="checkbox"/> 57600 ▾
UART1	<input checked="" type="checkbox"/> MSP 115200 ▾	<input type="checkbox"/> Blackbox 115200 ▾	Disabled ▾ AUTO ▾	<input type="checkbox"/> Serial RX	<input type="checkbox"/> 57600 ▾
UART2	<input type="checkbox"/> MSP 115200 ▾	<input type="checkbox"/> Blackbox 115200 ▾	Disabled ▾ AUTO ▾	<input type="checkbox"/> Serial RX	<input type="checkbox"/> 57600 ▾

Receiver Mode

- RX_PPM PPM RX input
- RX_SERIAL Serial-based receiver (SPEKSAT, SBLJS, SUMD)
- RX_PARALLEL_PWM PWM RX input (one wire per channel)
- RX_MSP MSP RX input (control via MSP port)

Serial Receiver Provider

Note: Remember to configure a Serial Port (via Ports tab) and choose a Serial Receiver Provider when using RX_SERIAL feature.

SPEKTRUM1024

SPEKTRUM2048

SBLJS

SUMD

13. QX105 DSM2/DSMX BNF Version binding procedure and Satellite receiver setup

1. The QX105 DSM2/DSMX BNF Version is integrate a DSM2/DSMX compatible Satellite receiver. The binding procedure is like

following:

- (1) Connect QX105 DSM2/DSMX BNF Version to computer and open Betaflight configurator, From CLI tab type: "set spektrum_sat_bind = 9" for DSMX radio or "set spektrum_sat_bind = 5" for DSM2 radio
- (2) Type "save" and after Flight controller reboot remove USB cable (=Power off the board)
- (3) Wait a second and reconnect the USB cable. After cold start satellite led (Orange color LED) should start blinking and transmitter should be turned on while pressing the bind button
- (4) After binding satellite led should be solid. Connect Betaflight and use receiver tab to test that satellite is working correctly.
- (5) Final step is to go to CLI tab and type "set spektrum_sat_bind = 0" and then type "save". This must be done so that satellite doesn't go back to binding mode when the QX105 is repowered again.

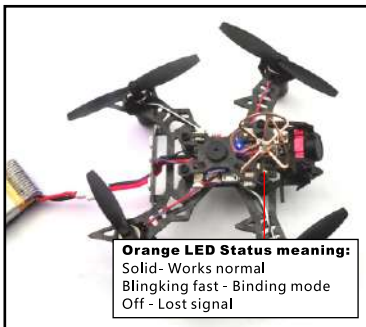

```

Entering CLI Mode, type 'exit' to return, or 'help'
# Set spektrum_sat_bind=9
spektrum_sat_bind set to 9
# save
For DSMX

Entering CLI Mode, type 'exit' to return, or 'help'
# Set spektrum_sat_bind=5
spektrum_sat_bind set to 5
# save
For DSM2

Entering CLI Mode, type 'exit' to return, or 'help'
# Set spektrum_sat_bind=0
spektrum_sat_bind set to 0
# save
Close Binding
  
```

2. The default receiver channel map for QX105 DSM2/DSMX Version is TAER1234, please ensure your transmitter is matched with it, otherwise it can't be armed.



14. Arm/Disarm QX105 DSM2/DSMX BNF version

1. The Default Arm/Disarm switch for QX105 DSM2/DSMX BNF Version is AUX1(Channel 5), for most of Spektrum radio the default channel 5 is Gear switch and you can also customize it with Betaflight Configurator. We also set the AUX2 (Channel 6) for change flight mode and AU3(Channel 7) for activate the buzzer which you can customize them too . Suggest use a 3-steps switch to change flight mode.

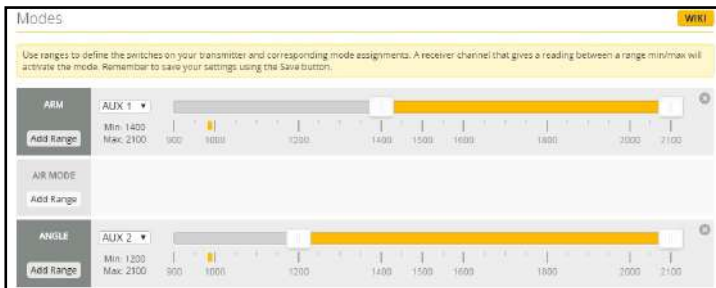

2. Turn on the transmitter and set a switch for CH5 to ARM/DISARM the motor, some transmitter like SPECKTRUM DX6/DX6I, the default CH5 is GEAR Switch.
3. Toggle the AUX1 Switch, The buzzer starts beeps one time and the Blue LED on the flight controller will first turning off and get be solid soon, this indicate the motor was armed. And also you can found "ARMED" shows on your FPV Goggles or the FPV Monitor. Be careful and enjoy your flight now



15. QX105 DSM2/DSMX BNF version receiver configuration

We have configured the satellite receiver for the QX105 before shipping. If you flashed the firmware, Please setup as the following steps: Enable Serial_RX for UART3 and Set Receiver mode RX_SERIAL, Select SPEKTRUM1024 for DSM2 Radio and Select SPEKTRUM2048 for DSMX Radio in Betaflight Configurator.

Ports

Note: Not all combinations are valid. When in the flight controller firmware detects this the serial port configuration will be reset.
 Note: Do NOT disable MSP on the first serial port unless you know what you are doing. You may have to reflash and redo your configuration if you do.

Identifier	Data	Logging	Telemetry	RX	GPS
USB VCP	<input checked="" type="checkbox"/> MSP 115200	<input type="checkbox"/> Bixbybox 115200	Disabled AUTO	<input type="checkbox"/> Serial RX	<input type="checkbox"/> 67800
UART1	<input checked="" type="checkbox"/> MSP 115200	<input type="checkbox"/> Bixbybox 115200	Disabled AUTO	<input type="checkbox"/> Serial RX	<input type="checkbox"/> 67800
UART2	<input type="checkbox"/> MSP 115200	<input type="checkbox"/> Bixbybox 115200	Disabled AUTO	<input type="checkbox"/> Serial RX	<input type="checkbox"/> 57700
UART3	<input type="checkbox"/> MSP 115200	<input type="checkbox"/> Bixbybox 115200	Disabled AUTO	<input checked="" type="checkbox"/> Serial RX	<input type="checkbox"/> 57800

Receiver Mode

- RX_PPM PPM RX input
- RX_SERIAL Serial-based receiver (SPEKSAT, SBUS, SUMD)
- RX_PARALLEL_PWM PWM RX input (one wire per channel)
- RX_MSP MSP RX input (control via MSP port)

Serial Receiver Provider

Note: Remember to configure a Serial Port (via Ports tab) and choose a Serial Receiver Provider when using RX_SERIAL feature.

- SPEKTRUM1024
- SPEKTRUM2048
- SBUS
- SUMD

For DSM2 Radio

For DSMX Radio

16. OSD configuration

1. Connect the QX105 to the computer , open Betaflight Configurator , move to the OSD option, then you can configure the layout of the OSD.



2. Craft Name set is in configuration option

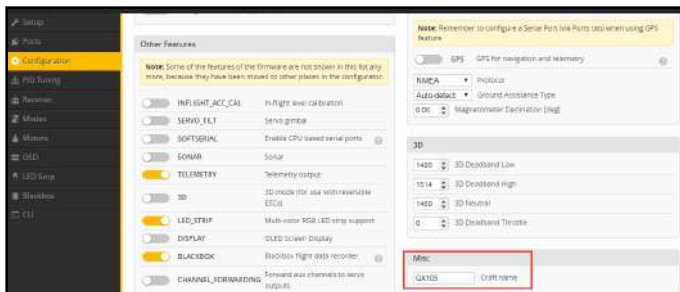

17. LED Strip function

The flight controller of QX105 can control colors and effects of individual LEDs on a strip. The default setup is like this, you can also customize by yourself effects.

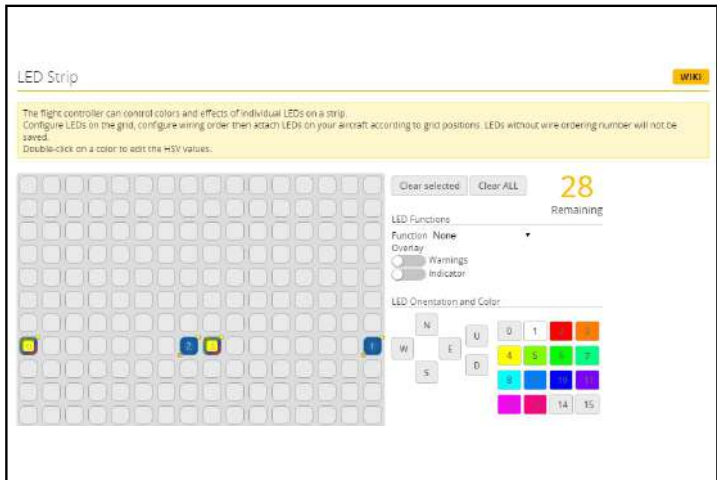

18. LED Strip status

	Disarmed
	Armed
	Brake
	4 LEDS Blinking Fast Throttle
	2 LEDS Blinking Fast Roll left
	2 LEDS Blinking Fast Roll right



www.eachine.com

*User manual is subject to change without prior notice.