

Instruction Manual

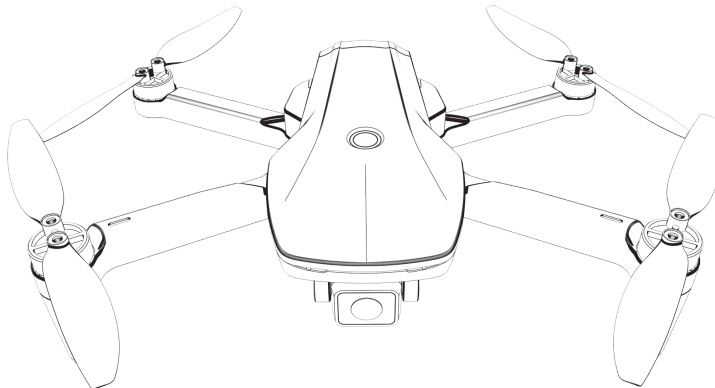

**GBK
UK
USA**

WARNING

choking hazard
not for children under 3 years due
to small parts included.



**ESP
ES**

ADVERTENCIA

Peligro de asfixia:
No es para niños menores de 3
años debido a las piezas
pequeñas incluidas.



**DEU
DE**

WARNING

Erstickungsgefahr :
Nicht für Kinder unter 3 Jahren
geeignet, da Kleinteile enthalten sind.



**ITA
IT**

AVVERTIMENTO

Pericolo di soffocamento:
Non per bambini sotto i 3 anni a
causa di piccole parti incluse.



**FRA
FR**

ATTENTION

risque d'étouffement
Pas pour les enfants de moins de 3
ans en raison de petites pièces incluses.



**JPN
JP**

警告

窒息の危険
小さな部品が含まれているため、3歳未
満のお子様には適していません。



متوافق وفقاً للمواصفات والمعايير العالمية
Tested according to international standards



تحتوي هذه الطائرة على أجزاء صغيرة
قد تكون خطرة على الأطفال إذا لم يتم
إشرفهم عليها. يرجى إبقاء هذه الطائرة بعيدة
عن متناول الأطفال دون سن 3 سنوات.
Small parts included. Not suitable for
children under 3 years old. Please keep this
drone away from children.



PRECAUCIONES:
PELIGRO DE AHOGARSE. Contiene partes pequeñas.
No recomendado para niños menores de 3 años.

SPECIFICATIONS AND COLORS OF CONTENTS MAY VARY FROM PHOTO.



This device complies with Part CE-RED of the CE Rules.
This device complies with Part 15 of the FCC Rules.

MADE IN CHINA **CHN**

Fabricado en China

Fatto in Cina

Fabriqué en Chine
In China Hergestellt
中國製



RoHS

R 214-128222

Brand: Eachine

Model No: EX5

Product: Drone

Batch No: 0036847

Manufacturer: Shenzhen Feijiada Technology Co., Ltd.

Address: Room 428, No.2 Jinfanghua E-commerce Industrial Park, No.450
Bulong road, Longgang dis-trict, Shenzhen City, Guangdong, China.

EC

REP

Importer: Lotus NL B.V.
Address: Koningin Julianaplein 10,
1e Verd. 2595AA, The Hague, Netherlands.
E-mail: peter@lotusnl.com



Important Statement and Safety Guidelines

Thank you for choosing this product, in order to help you use this drone more easily, please read this manual carefully before operating it, and please keep this manual properly for future adjustment and maintenance.

Important Statement

- This product is not a toy, it integrates expertise in mechanics, electronics, aerodynamics, high-frequency launching, etc. This drone integrates precise equipment, which requires proper assembly and commissioning to avoid accidents. The drone holder must operate the drone in a safe way; improper handling will cause serious personal injury or property damage.
- This product is suitable for people who have experience in operating drone and over 14 years old.
- If you have any questions about use, operation and maintenance, please contact your local dealer or the relevant staff of the company. We and the seller are not responsible for any injury or damage caused by improper use or operation.
- The product contains tiny parts, so keep them out of reach of children to avoid eating or suffocating.

Safety Precautions

The RC drone is a dangerous commodity, please stay away from the crowd while flying. Improper assembly or damage to the drone, poor electronic control, and unfamiliar operation can cause unpredictable accidents such as drone damage or personal injury. Pilots should pay attention to flight safety, and understand the responsibility of the accident caused by negligence.

- Stay away from obstacles and people

The flying drone has an uncertain flight speed and state, there is a potential danger. Keep away from crowds, high-rise buildings, high-voltage power lines, etc., and avoid flying in windy, rainy and lightning weather. Commissioning and installing the drone must be strictly in accordance with the instruction, the distance between the drone and the people should maintain in 1-2 meters. Avoiding the drone hit the head, face, and body when flying and landing.

drone hit the head, face, and body when flying and landing.

- Keep away from the humid environment

The interior of the drone is composed of many sophisticated electronic components and mechanical parts. Therefore, it is necessary to prevent the drone from getting wet or moisture, so as to avoid accidents caused by mechanical and electronic components. Use a clean rag to clean the surface stains during maintenance.

- Guided by an experienced pilot

The control skills have certain difficulties in the early stage of learning. Try to avoid flying alone, and you need to be guided by experienced people.

- Use this product correctly

Please repair the drone with original parts to ensure the safety of the flight. Please operate the product within the scope permitted by the product features and may not be used for illegal purposes other than the safety laws.

- Safe operation

1. Please operate the drone only you are in good status and have flying skills. Fatigue, trance or improper operation will increase unexpected risks.

2. Don't use it near your ears! Misuse can cause hearing damage.

- Keep away from high speed rotating parts

When the motors of the drone are rotating at high speed, please keep the motors away from the pilot, surrounding crowd, and objects to avoid personal injury and damage to the drone.

- Keep the drone away from heat

The drone is made of metal, fiber, plastic, electronic components, and other materials, so it should be kept away from heat sources, and avoid direct sunlight and high temperature to avoid deformation of the drone.

- Environmental requirements

Discarding this product at will may pollute the environment. Please dispose properly according to the local laws and regulations.

Product Description

Package includes

EX5 drone x 1 Blades x 2 Screwdriver x 1 USB charging cable x 1 Remote control x 1 Battery x 1

Basic parameters

Wheelbase: 230mm Fuselage height: 52mm Fuselage weight: about 225g Battery: 7.4V 2200mAh 25C

Charging time: about 4 hours Flight time: about 25-30 minutes

Blade installation / demolition

Blade installation:

Install the A blade on the fixed position of the arm A, install the B blade on the fixed position of the arm B. Use a screwdriver to unscrew the screw and remove the blade, then replace a new one (included in the package), lock the screw and lock it in place.

Blade demolition :

Please turn the screw counterclockwise to remove the screw on the blade, and then remove the blade

⚠ Tips: Please install the accessories properly in the order shown in the figure below, the blade have front and back sides, be care the direction of rotation. be careful to tighten the screws.

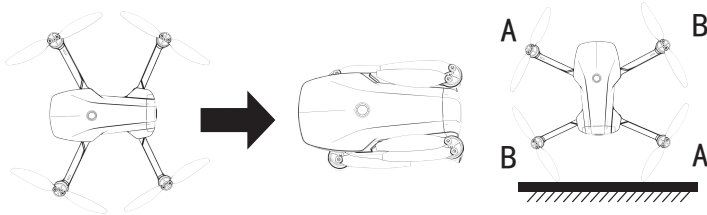

⚠

- Make sure that the A and B blades are installed in the correct position. If install the blades improperly, it can't be taken off.
- Since the blade is thin, be careful to prevent accidental scratches when installing.
- Please use the original blade provided by our factory.
- Blade is consumable. If necessary, please purchase separately.

Charge the drone battery

Pull the battery out of the main body of the aircraft, plug the USB into the charger, and insert the battery into the USB output terminal. The red light of the battery is always on and the green light is flashing to start charging. When the charging is completed, the red and green lights are on for a long time, and the charging time is about 240 minutes.

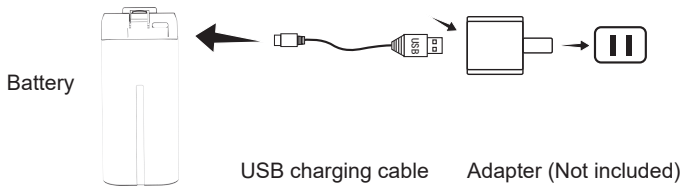

⚠ Warning:

- Do not charge the battery on the carpet to avoid fire. We will not take any responsibility for injury and damage, caused by the improper charging.
- Insert the plug correctly. Do not insert in the reverse direction.
- It is recommended to use the 5V 1-2A adapter for charging.

It is not recommended to use the computer USB port for charging.

Installation of Drone Battery

Push the battery into the battery slot of the drone, and the battery is fully clamped in the drone, The cover fully buckles the drone shell. Check to make sure the battery is in place.

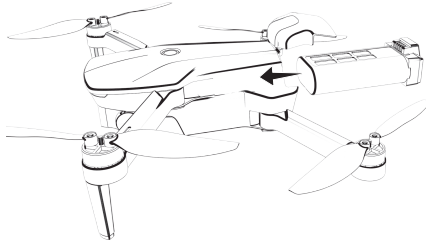

Warning: If the battery is not installed properly or lock tightly, it may cause the drone to lose power and accidentally fall.

- ⚠ •When charging the rechargeable battery, please keep away from children, it must be carried out under adult supervision, and must be kept away from flammable materials during charging, and the guardian should not leave the battery outside the monitoring range when charging.
- Please do not short circuit or squeeze the battery to avoid accident.
- Do not place the battery in a high-temperature place (such as a fire or an electric heat source near the device).
- The battery can only charge by the recommended charger, the battery and charger can't get wet, The drone can be wiped with clean rag, pulling out the battery and disconnect from the charger before cleaning, periodically check the chargers wires, plugs, housing and others. If the part is damaged, stop using it when it is found to be damaged until it is repaired.
- ⚠ •The charger is not a toy; the charger can only be used indoors.
- The battery after the flight needs to be recharged before stored. If you don't use the battery, it is recommended to charge the battery once at least in every 3 months to prevent the battery from being over-discharged and permanently damaging the battery.

Introduction of drone fuselage

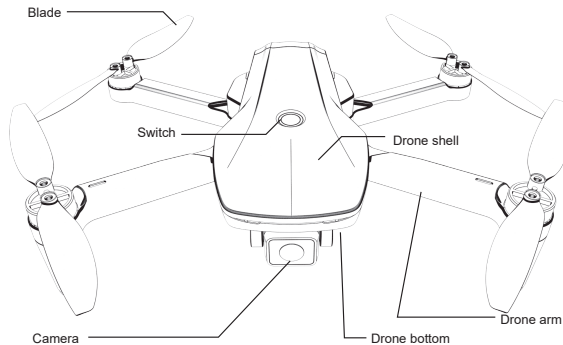

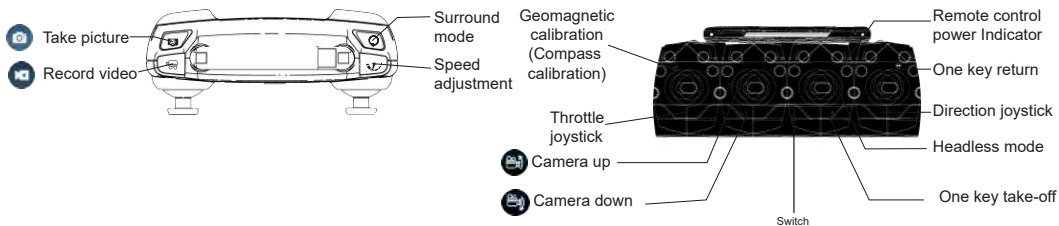

Controller function introduction

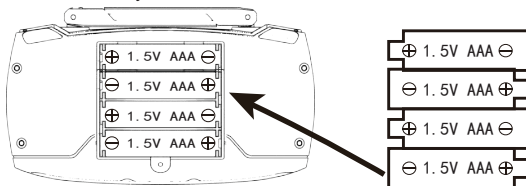

Install the remote control battery

Remove the remote control battery cover, install the 4 Pcs AAA batteries(Not provided in the package) correctly according to the positive and negative terminals indicated by the remote control, and then re-install the battery cover.



-  • The remote control uses 4 "AAA" non-rechargeable batteries or "AAA" rechargeable batteries. (Not provided in the package)
- Pay attention to the polarity of the battery when installing or replacing the battery.
 - Do not mix different conditions or types of batteries.
 - Used batteries should be removed in time, and discarded batteries should be thrown properly.
 - If you do not use it for a long time, please remove the battery to avoid damage to the product caused by battery leakage.

Synchronize the drone with the remote control.

Step 1 :Insert the battery into the battery slot of the drone. Press the power button of the drone for two seconds to turn it on. The indicator light of the drone flashes quickly and then flashes slowly. Put the drone on the horizontal ground or glass. (Do not place the drone on the grass or on uneven ground to prevent the grass or sand from getting into the motor and causing damage to the motor.)

Step 2 :Turn on the remote control power switch, the indicator light of remote control and drone turn solid, the synchronization is completed.

Tips: Long press the speed control button and turn on the remote control switch at the same time.The left joystick will become the direction joystick, and the right joystick will become the throttle joystick. (right-hand mode)

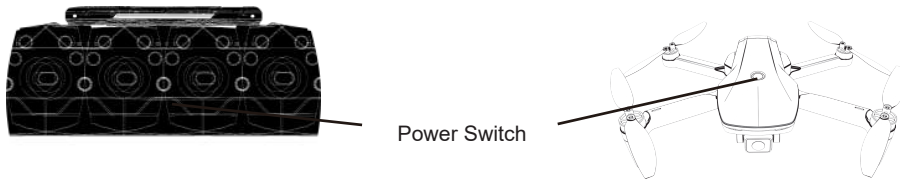

- ⚠️ • If the drone is not synchronized with other remote controllers, as long as the synchronization is successful, you do not need to synchronize the remote controller and the drone again.
- When the remote control is synchronized with the drone, make sure that the other remote control and drone are not powered on at the same time, otherwise, the synchronization may fail.

Drone Initialization Detection

After the synchronizing procedure is finished, it will automatically begin the initialization detection. In the meantime, and the drone needs about 8 seconds to complete the initialization detection on the horizontal ground. Next, the drone needs to begin the Gyro Calibration.

Gyro Calibration

After the synchronization is successful and drone initialization detection is completed, keep the drone on the horizontal ground, push the left and right joysticks 45° to the lower right corner at the same time, as shown in the figure below. Then the front and back indicators of the drone flash quickly, and the gyroscope is being calibrated. Finally, the indicator light changes from flashing to steady. The gyroscope calibration is completed.

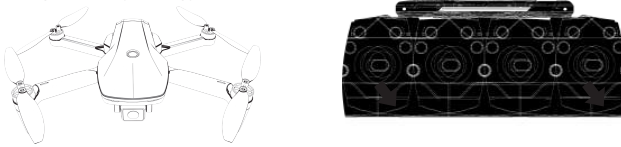

- ⚠️ • When performing the gyroscope calibration procedure, make sure to put the drone on a level surface, otherwise, the drone can't fly in balance.
- Performing the gyroscope calibration procedure each time before taking off.

Compass Calibration

After the drone and the remote controller are successfully synchronized, complete the initialization test and perform the gyro calibration, then the drone can begin the compass calibration. Every time before the drone takes off, it must be performed compass calibration, otherwise, the drone will not be able to fly normally.

Compass calibration is divided into two steps:

Step 1: Compass horizontal calibration (Figure 1)

Press the compass calibration button

Then spin the drone by hand as shown below and rotate it counterclockwise horizontally for about 3 times until the remote control beeps and the rear indicator light of the drone stays on., the horizontal calibration is completed.

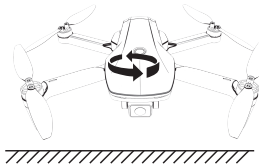

Step 2: Compass vertical calibration (Figure 2)

Erecting the drone and rotate the drone by hand, as shown in the figure 2 below, rotate the fuselage clockwise about 3 times until the remote control beeps and the rear indicator light of the drone stays on.. The compass calibration is complete.

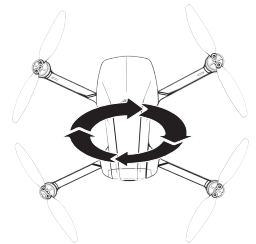

- ⚠ Note: The best distance between the ground and the drone should be more than 1 meter during calibration.
- Do not perform compass calibration in areas with strong magnetic fields, such as magnetite, parking lot, building area, electric tower, etc.
- During calibration, please do not carry ferromagnetic materials with you, such as keys or mobile phones.
- Do not perform compass calibration near bulk metal.

Search satellite signals: After the compass calibration procedure is completed, put the drone on the flat ground, the drone will automatically search for the satellite signal, the rear indicator light of the drone will change from slow flashing to steady light and the remote control beeps, then the search satellite signal procedure is completed. Unlock the drone by pushing the left joystick to left 45° and the right joystick to the right 45° at the same time (as the picture is shown), the motors will spin, then push the throttle stick up, the drone will take off. then the search satellite signal procedure is completed. Unlock the drone by pushing the left joystick to left 45° and the right joystick to the right 45° at the same time (as the picture is shown), the motors will spin, then push the throttle stick up, the drone will take off.

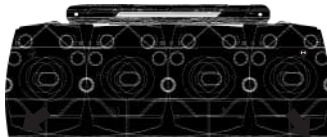

Tips: Please make sure that the drone flies in wide-open space and the satellite signal is more than 7 stars show in the app before take-off

Application installation instructions

Step 1: Please scan the QR code below to download the App name EACHINE PRO.



Step 2: Connect the drone with your mobile device follow the steps below

- ① Turn on the drone.
- ② Go to WLAN setting in your mobile device and search the wifi name:
WiFi-5G4K-GPS -EX5-XXXXXX
- ③ Connect the mobile device with the drone via wifi.
- ④ Launch the EACHINE PRO app, the you can control the drone from your mobile device

Warning: Your mobile phone Wi-Fi require support IEEE 802.11a/b/g/n/ac, which is 5G band WLAN

Tips:

Only one mobile device is allowed to connect to a drone via wifi at a time

Note: When the drone is flying in the following environment, the optical flow positioning function of the bottom camera is not good, resulting in unstable hovering and the drone is difficult to fly smoothly, and even the drone drifting.

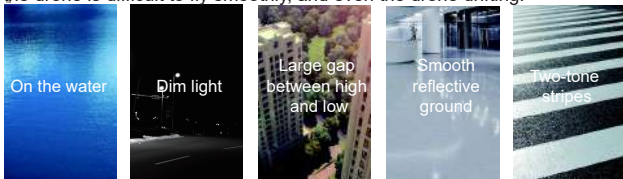

When the drone is flying indoors and cannot receive satellite signals, the drone will automatically turn on the optical flow mode. When the drone is flying outdoors and can receive satellite signals, the drone turns on the GPS mode.

Recommended mobile device models and configurations IOS system

model and configuration	Recommended model	Best model
Product type	iPhone 6 and newer models	iPhone 7 and newer models
Operating system version	IOS 8.0 and newer system	IOS 9.0 and newer system

Android system

model and configuration	Recommended model	Best model
CPU model	Snapdragon 630 and newer models	Snapdragon 835 and newer models
	Samsung Exynos 7420 and newer models	Samsung Exynos 8895 and newer models
	Helio X25 and newer models	Helio 970 and newer models
	Kirin 950 and newer models	Kirin 970 and newer models
Operating system version	Android 5.0 and newer models	Android 8.0 and newer models
RAM	3G and above	6G and above
CPU usage	CPU usage 25% and below	CPU usage 10% and below

1.1 Application interface introduction

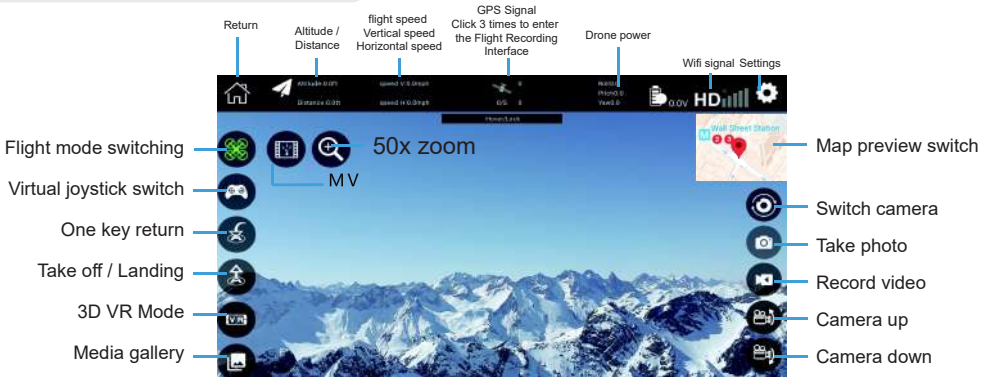

1.2 Flight Recording Interface

Record drone flight parameters, tap You can switch to the map, you can check the last position of the drone according to the route

select all		Flight record			
Date	Flight time	Maximum flight distance	Maximum flight altitude	Maximum lifting speed	Maximum speed
	5 minutes 6 seconds				

1.3 Gesture Recognition

Facing the front camera, the following gestures can trigger the drone to automatically take pictures or record videos:



Yeah gesture trigger the drone to take photo
 In front of the drone's front camera about 2 meters, make Yeah gesture with one hand raised;
 Make sure the drone clearly captures the gesture. When the drone successfully recognizes the gesture, it will count down 3 seconds and start taking pictures, You can see the application interface countdown for 3 seconds.



Palm gesture trigger the drone to record video
 In front of the drone's front camera about 2 meters, close up your five fingers and lift with one hand:
 After the drone successfully recognizes the gesture, it will start recording, and when the gesture is recognized again, the recording will end (the time between the two recognition should be greater than 3 seconds).

Tips:

In order to ensure that the lens obtains a high recognition rate:

1. Please aim at the lens.
2. Please fly in a well-lit environment.
3. Please perform gesture recognition operation at a position about 2m away from the lens.

In the following cases, the lens recognition rate will decrease:

1. Weak light or backlight environment
2. The Wi-Fi signal is weak or the signal is interfered

1.4 Flight mode switching



Support 4 flight modes

1. Self-stability mode: The drone automatically hover and stable flight, the joystick can be used to control the drone.
 Waypoint mode: The drone is flying along the route you set. You can set each waypoint to plan the flight route of the drone.

3. Follow me mode:

1. When the drone is flying outdoors. The drone can receive GPS signals. In GPS mode, the drone will follow the coordinates of the mobile device.
2. When the drone is flying indoors, the drone will recognize the portrait, so as to follow the person forward and backward, or even turn left and right.
4. Surround mode, the drone circle around the remote control in the surround mode.

Waypoint mode: The drone is flying along the route you set. You can set each waypoint to plan the flight route of the drone.

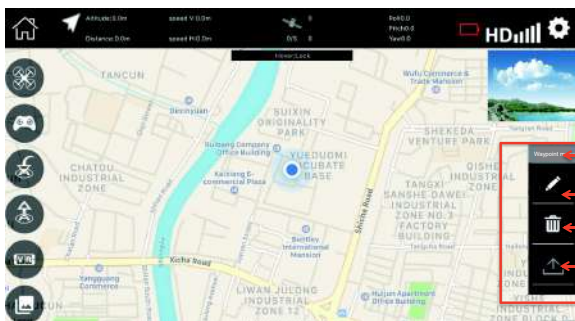

Set waypoints by continuously drawing lines.

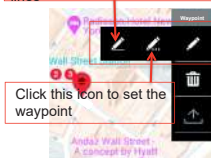

Click this icon to set the waypoint.

Delete a single waypoint: Tab this icon and then click the waypoint you want to delete.



Delete all waypoint

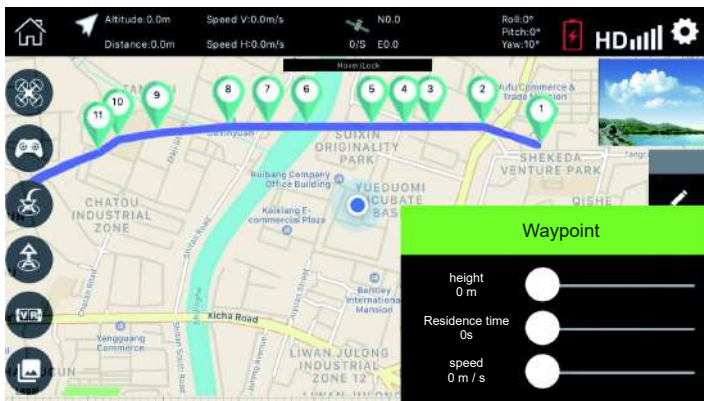

Waypoint parameter setting
 Click the waypoint to be set, and the setting menu will pop up.
 Hold down the ball and slide to modify the parameters.

Press the Self-stabilizing mode , the waypoint mode will exit.

2. MV Interface introduction

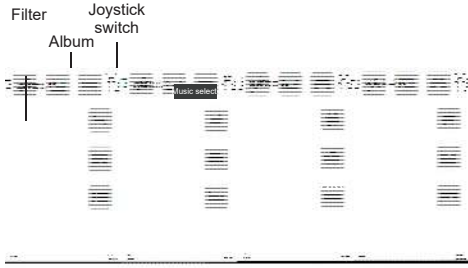

Tap this icon which located in the upper left corner of the main interface, you will enter the MV Interface, in this interface, you can take the video and add background music to the video.

Rotate the picture

Click this icon to enable the rotating picture function. Meanwhile, your finger slides the screen, the image can be rotated; if you double-tap anywhere on the screen with your finger, you can zoom in the image.

2.1 Filter Interface introduction

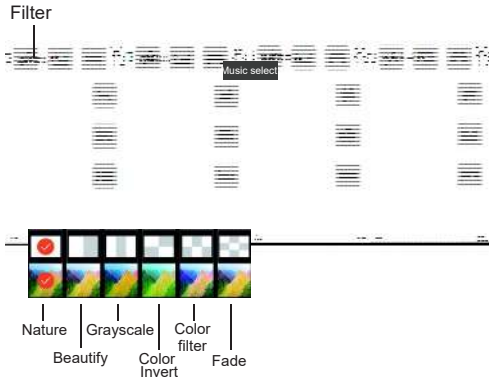

Tap this icon which located in the upper left corner of the MV interface, you can launch the filter function. There are 9 kinds of filters to choose.

2.2 Music selection interface

Tap the music icon of the MV interface, you can choose the music of the video.

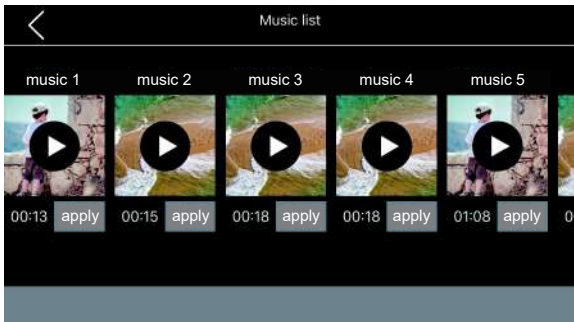

Music list, slide left and right to choose

Setting

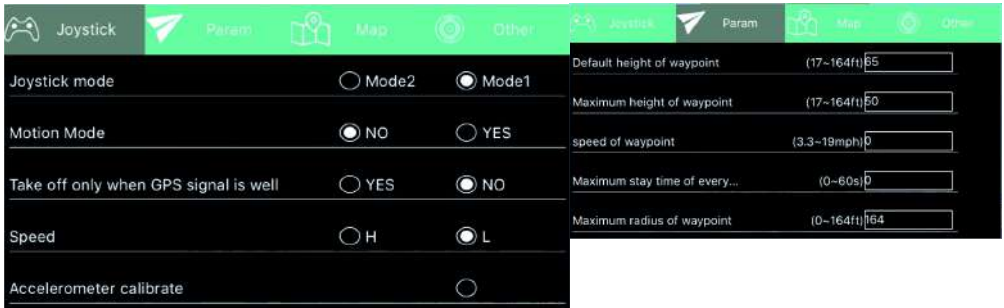

Mode 1: The throttle joystick on the right side, Mode 2: the throttle joystick on the left side.
Accelerometer calibrate means the Gyro calibration.

Magnetometer calibrate means the Compass Calibration.

Attention, when you activate the waypoint function and orbit mode, the drone will automatically ascend to the default height, please do not set the altitude too much.

Warning: The factory has already set the parameters, it is generally not recommended that you modify it by yourself.

Flight



Basic Flight Step



1. Synchronize the remote control and the drone, then the drone will automatically finish initializing.
2. Perform the Gyro Calibration procedure.
3. Download the APP and pair the drone with the mobile phone by Wifi.
4. Performing the Compass Calibration procedure. Waiting for the drone automatically search satellite signals, usually 60-80 seconds (check the main interface of app, signals should be more than 7 stars), until the rear light of the drone is steady on, signals receiving finish.
5. Unlock the drone, then push up the throttle stick of the remote control, the drone takes off, could use the APP to controls the drone.

Pre-Flight Inspection

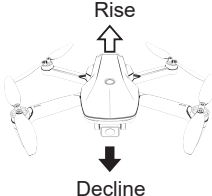
1. Ensure the battery of remote control and drone are fully charged.
2. Ensure the blades installed correctly
3. Ensure the motor works fine.
4. Make sure the compass calibration is successful.
5. Make sure the GPS signal is more than 7 stars.

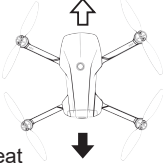
Flight Control

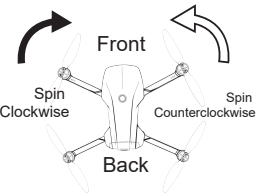
Remote control	Drone
	<p>Rise</p>  <p>Decline</p>
	<p>Go ahead</p>  <p>Retreat</p>

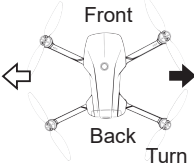
Remote control	Drone
	<p>Front</p>  <p>Spin Clockwise</p> <p>Spin Counterclockwise</p> <p>Back</p>
	<p>Turn left</p>  <p>Turn right</p>

Flight Mode

One key take off

- After the drone is unlocked, press the "↑" button and the drone will automatically take off and raise about 1.5 meters to hover.



Surround mode

The drone flies 20 meters or higher from the ground. Press the surround button and the direction of rotation of the drone will turn to the north. When the head turns back to the previous flight direction and hover in the air, push the remote control direction joystick to the left, the drone will circle around you counterclockwise, push the remote control direction joystick to the right, the drone will circle around you clockwise.

In the surround mode, press and hold the direction joystick, the drone will accelerate to the fastest 2.5M/S according to the current speed. Push up the direction joystick to expand the circle radius. The maximum radius is about 20 meters. Pull down the direction joystick to reduce the circle radius, the minimum radius is about 5 meters, press the surround button again to exit the surround mode.

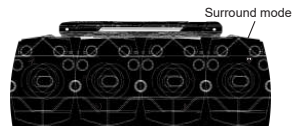

Headless Mode

Before using the headless mode, the drone should rise 5 meters from the ground.

Pressing the headless mode button to activate the headless mode, Then the rear indicator light of the drone will flash quickly and the remote control beeps , headless mode on. Pressing the headless mode button again to exit.



Return

The drone has a return function. if the starting point is successfully recorded before take off, When the signal between the remote control and the drone is lost or the return button is pressed, the drone will automatically return to the starting point and land to prevent accidents.

The drone has three different return modes:

1. One-key return (the drone will automatically return to the starting point by pressed the One-key return button)
2. Out of control return (the drone will automatically return to the starting point, when it beyond the remote control range or loses connection)
3. Low power return. (The drone will automatically return to the starting point, when drone is in low power)

Starting point:

During the take-off or flight, when the GPS signal strength is more than 7 stars for the first time, the current position of the drone will be recorded as the starting point.

One-key Return

When the GPS signal strength is more than 7 stars, the drone can be returned by pressing the one-key return button of the remote control. The one-key return process is the same as the out of control return, but the user can control the drone through the joystick to avoid obstacles, when the drone returns near to the landing. Press the one key return button again, you can exit automatic flight and the user can regain control.



Out of control return

When the GPS signal strength is more than 7 stars and the compass works fine, after the drone successfully records the starting point, if the remote control signal is lost for more than 6 seconds, the flight control system will take over control of the drone and control the drone to fly back to the starting point. If the remote control signal is restored during the flight, the return flight process will continue, but the user can exit the flight control system and regain control of the drone by press one-key return button of the remote control.

-  **Precautions:**
- The drone cannot dodge obstacles during the automatic return flight.
 - When the GPS signal is not good or the GPS function is not working, it cannot be returned.
 - If the drone does not receive the GPS signal and the remote control signal is lost more than 6 seconds, the drone will not be able to return to the starting point, and it will slowly descend, land and lock.

Low Power Return

• The rear indicator light of the drone flashes slowly. At this time, the remote control continuously emits “beep beep beep..” As long as the drone is fly higher than 20 meters or the distance is farther than 20 meters, the drone will automatically perform the return function. Fly back to the starting point.

- When the voltage of drone below the safe value, the drone will automatically fall to the starting point.

 **Tips:** When the drone is in a low-power state and returns to the starting point, the remote control cannot cancel the returning.

Take Photo / Record Video

During the flight, the camera can adjust the angle up or down, press the camera up button of the remote control each time, the camera lens ascends about 10 degrees and the controller emits a beep. When the camera is at the maximum angle, no matter how many times you press the button, the controller will remain silent, the camera will not rise, the camera down button is the same.

During the flight, you can use the camera or video button of the remote control to capture the aerial image or video. Press the camera button and the remote control emits "beep" and the APP emits "KA", the camera will take a photo. Long press the video button, the remote control beeps twice, and the camera will start recording video. Long press this button again to exit the recording video mode.

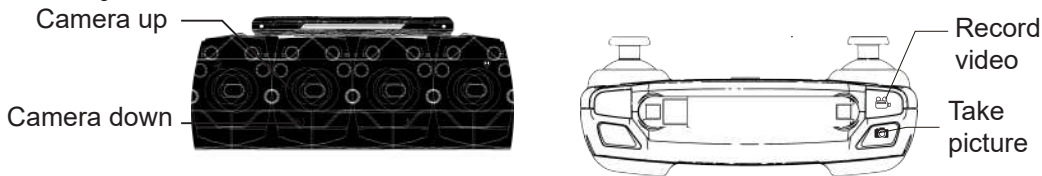

Trouble shooting

Number	Problem	solution
1	When the drone power on , the indicator light keeps flash rapidly	The drone is in the gyro calibration status, please place the drone in the flat ground.
2	After the drone takes off ,it can't hover in the air and drifts to the side.	Place the drone on the flat ground and recalibrate the gyro.
3	The drone shakes badly	Indicates that the blade is deformed and needs to be replaced
4	The drone cannot be unlocked, the rear indicator light flashes rapidly	Drone battery has low voltage and needs to be charged
5	Drone flying unstable in windy weather.	Before flying the drone, Wait until the wind is at level 4-5.(Breeze)
6	Can't hover in the air and keep circle around	Compass calibration failed, please recalibrate the compass.