

 **LIZARD 105S**  
QUICK START GUIDE V1.0

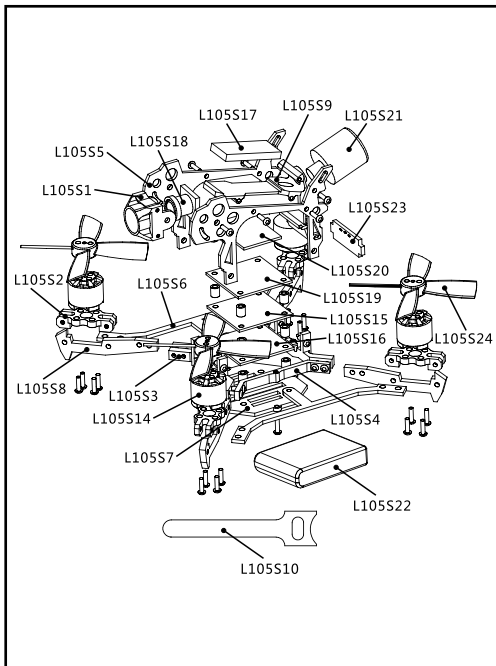

Item	Qty	Part No.	Option
Camera mount holder	1	L105S1	
Motor mount holder	4	L105S2	
CNC Alloy Front/Rear stiffener	2	L105S3	
CNC Alloy Side stiffener	2	L105S4	
3K Carbon side plate	2	L105S5	
3K Carbon bottom stiffener	2	L105S6	
3K Carbon bottom plate	1	L105S7	
3K Carbon arm	4	L105S8	
VTX&Receiver fixed plate	1	L105S9	
Battery cable ties	1	L105S10	
Hexagonal columns	1	L105S11	
Screws set	1	L105S12	
Battery anti-slip adhesive mat	1	L105S13	
Eachine 1104 KV6000	4	L105S14	
Omnibus F4 PRO Corner NANO	1	L105S15	
BS-28A 4in1 ESC	1	L105S16	
		L105S17FR	Frsky
2.4G Receiver(Optional)	1	L105S17FL	Flysky
		L105S17DX	DSMX
720P HD CMOS 1/4" Camera	1	L105S18	
720P HD DVR	1	L105S19	
5.8G 25mw/200mw 48CH VTX	1	L105S20	
UXII Antenna U.FL Connector	1	L105S21	
14.8V 4S 550mah 60C Lipo battery	1	L105S22	
WS2812 LED Board + Buzzer	1	L105S23	
2435PRO propeller(2cw+2ccw)	2	L105S24	
Purple Propeller Guard(4pcs)	1	L105S25	

## 1. Specifications

Item Name: Lizard 105S Micro FPV RACING DRONES BNF

Size:130mm\*130mm\*53mm

Weight: 80g( battery not include)

Flight controller: F4 Flight controller built-in OSD with

Damping box IMU

Motor: Eachine 1104 KV6000 brushless motor

ESC:BS-28A 4IN1 ESC DSHOT600 Ready

Propeller: 60mm 4-blades propeller

Camera: 130Degree 720P Camera

DVR: 1280\*720 Real HD Video recorder

VTX: 5.8g 25MW/200MW Switchable 48CH Video transmitter

Battery: 14.8V 550mah 60C lipo battery

OSD: Betaflight OSD

Firmware of Flight controller :Betaflight 3.2

Rear LED Ready( LED\_Strip function)

Buzzer Ready

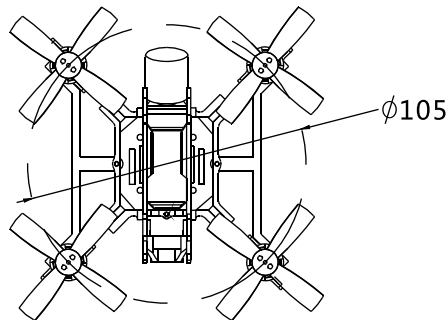
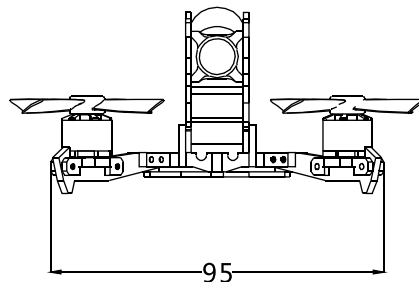

2. Components	QTY	Part NO
Lizard 105S Frame	1	L105SF
Omnibus F4 corner Nano flight controller with MPU6000	1	L105S15
BS-28A 4IN1 ESC	1	L105S16
2.4G Receiver(Option: Frsky XM+ /Flysky Flit10/SPEKTRUM DSMX)	1	L105S17FR/FL/DX
720p HD CMOS 1/4 Camera +720P DVR	1	L105S18+L105S19
5.8g 25MW/200MW Adjustable 48CH VTX+UXII Antenna	1	L105S20+L105S21
Eachine 1104 KV6000 brushless motor	4	L105S14
2435PRO Propellers+Propeller guarder	4	L105S24
14.8v 550mah 60C Lipo battery	1	L105S22
WS2812 LED Board+Buzzer	1	L105S23

### 3. Flight controller connection diagram

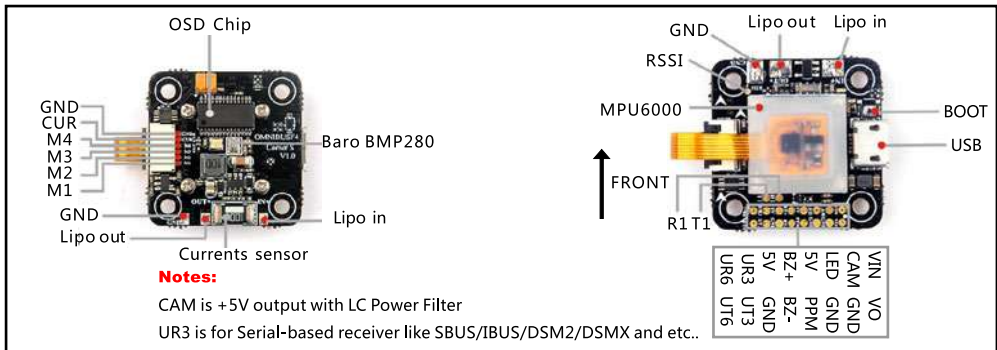

#### 4. ESC Connection diagram and Frame type

Mixer

Quad X

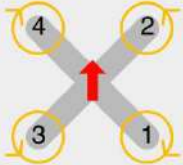

Fix the 2435PRO(R) propeller onto the M1 and M4 motor(CW Motor),  
Fix the 2435PRO(L) propeller onto the M2 and M3 motor(CCW motor)

⚠️ Cautions: Be sure to tighten the screws

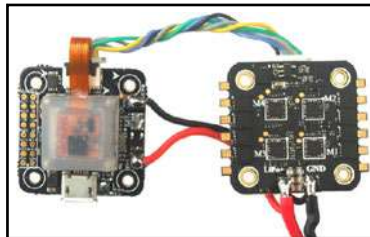
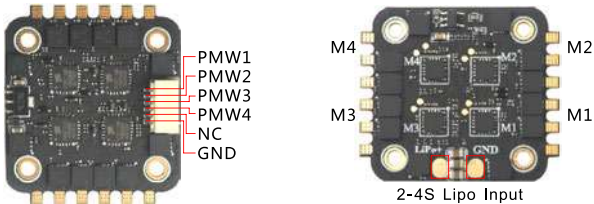
PMW1  
PMW2  
PMW3  
PMW4  
NC  
GND

M4 M2  
M3 M1

2-4S Lipo Input

**Notes:** If you want to USE current sensor , please use 14AWG Silicone wire and change the power wire connection order as bellowing



## 5. VTX connection diagram

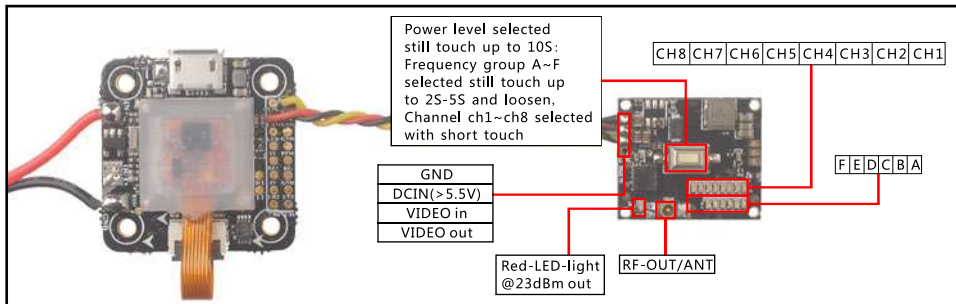

### ■ Band and channel

CH \ FR		FR					
		A	B	C	D	E	F
CH	CH1	5740MHz	5705MHz	5865MHz	5658MHz	5733MHz	5362MHz
	CH2	5760MHz	5685MHz	5845MHz	5695MHz	5752MHz	5399MHz
	CH3	5780MHz	5665MHz	5825MHz	5732MHz	5771MHz	5436MHz
	CH4	5800MHz	5645MHz	5805MHz	5769MHz	5790MHz	5473MHz
	CH5	5820MHz	5885MHz	5785MHz	5806MHz	5809MHz	5510MHz
	CH6	5840MHz	5905MHz	5765MHz	5843MHz	5828MHz	5547MHz
	CH7	5860MHz	5925MHz	5745MHz	5880MHz	5847MHz	5584MHz
	CH8	5880MHz	5945MHz	5725MHz	5917MHz	5866MHz	5621MHz

## 6. DVR connection diagram and Operating instructions

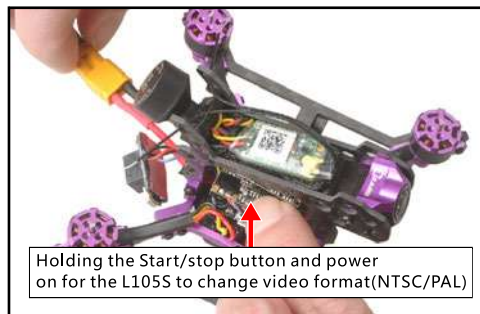
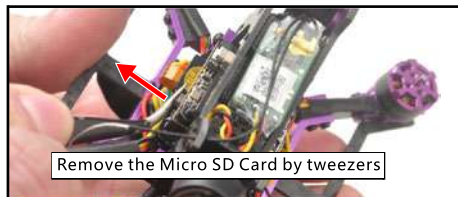
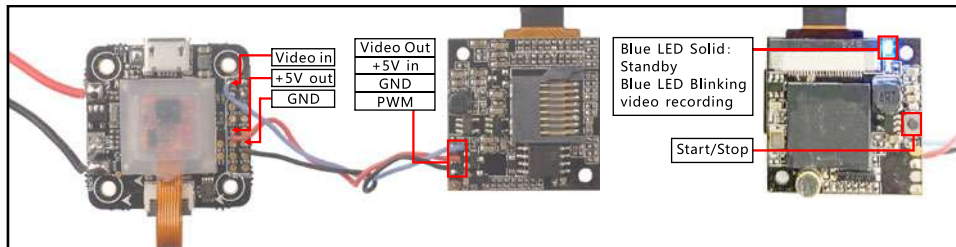

**Notes:**

The DVR will auto starting to record video when power on

## 7. 2.4G Receiver connection diagram

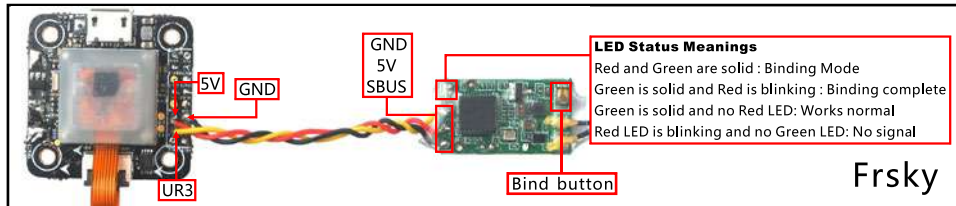

Diagram showing the connection of a Frsky 2.4G receiver to an Eachine receiver board. The receiver board has a USB port labeled UR3. The receiver board has pins for 5V, GND, GND, 5V, SBUS, and a Bind button. The receiver board has two LEDs.

**LED Status Meanings**

- Red and Green are solid : Binding Mode
- Green is solid and Red is blinking : Binding complete
- Green is solid and no Red LED: Works normal
- Red LED is blinking and no Green LED: No signal

Frsky

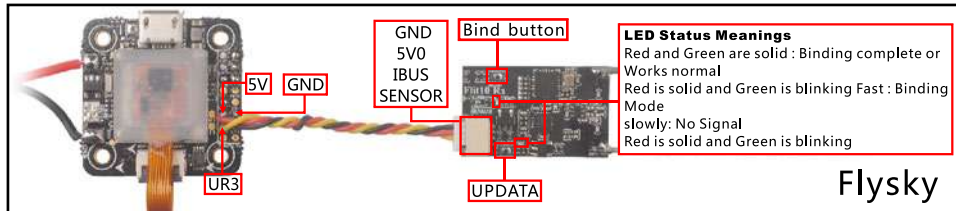

Diagram showing the connection of a Flysky 2.4G receiver to an Eachine receiver board. The receiver board has a USB port labeled UR3. The receiver board has pins for 5V, GND, GND, 5V, IBUS SENSOR, and a Bind button. The receiver board has two LEDs.

**LED Status Meanings**

- Red and Green are solid : Binding complete or Works normal
- Red is solid and Green is blinking Fast : Binding Mode
- slowly: No Signal
- Red is solid and Green is blinking

Flysky

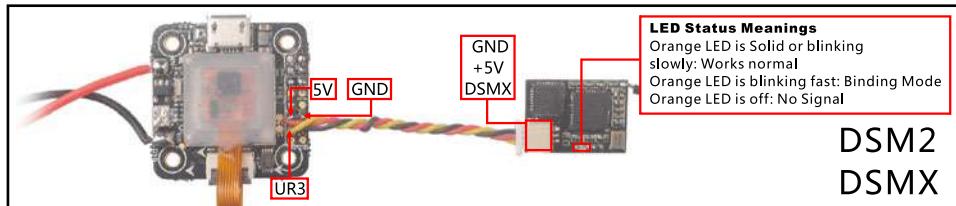

Diagram showing the connection of a DSM2/DSMX 2.4G receiver to an Eachine receiver board. The receiver board has a USB port labeled UR3. The receiver board has pins for 5V, GND, GND, +5V, DSMX, and a Bind button. The receiver board has one LED.

**LED Status Meanings**

- Orange LED is Solid or blinking slowly: Works normal
- Orange LED is blinking fast: Binding Mode
- Orange LED is off: No Signal

DSM2  
DSMX



## 8. Lizard 105S Frsky BNF Version binding procedue

1.Connect the battery while holding the bind button in the Frsky receiver, the green and red LED on the receiver will getting to be solid, this indicates the Lizard105S is ready to bind with the transmitter, then release the bind button.

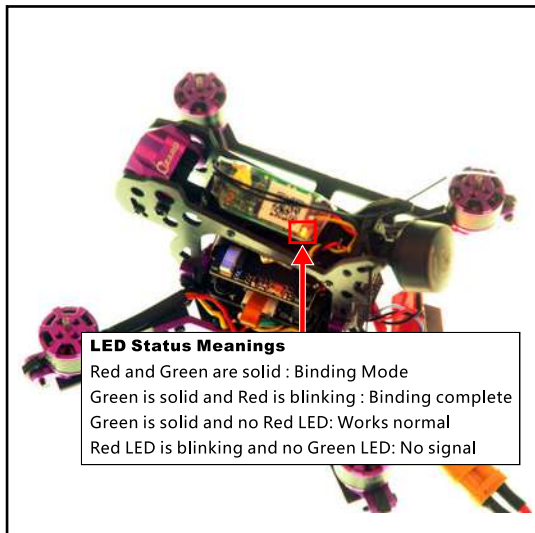
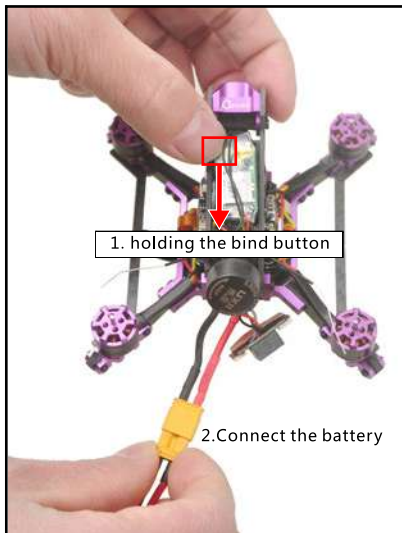

2. Turn on the transmitter and select D16 mode from the Model SETUP Tab, then go to the Receiver [Bind] tab and Enter to binding with the Lizard105S. The Green LED on the receiver should get to be solid and the Red LED starts to blinking, this indicates binding successful.

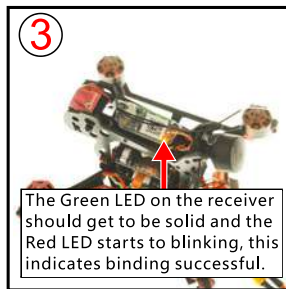

3.The Default channel map for Lizard105S Frsky version is “TAER1234” , Please ensure your transmitter is matched with it ,otherwise it can't be armed.

Receiver
WIKI

Please read receiver chapter of the documentation. Configure serial port (if required), receiver mode (serial/ppm/pwm), provider (for serial receivers), bind receiver, set channel map, configure channel endpoints/range on TX so that all channels go from -1000 to -2000. Set midpoint (default 1500), trim channels to 1500, configure stick deadband, verify behaviour when TX is off or out of range.

**IMPORTANT:** Before flying read failsafe chapter of documentation and configure failsafe.

Roll [A]	<div style="width: 100%; height: 10px; background: linear-gradient(to right, red, red);"></div>	1500	
Pitch [E]	<div style="width: 100%; height: 10px; background: linear-gradient(to right, purple, purple);"></div>	1500	
Yaw [R]	<div style="width: 100%; height: 10px; background: linear-gradient(to right, blue, blue);"></div>	1500	
Throttle [T]	<div style="width: 100%; height: 10px; background: linear-gradient(to right, cyan, cyan);"></div>	987	
AUX 1	<div style="width: 100%; height: 10px; background: linear-gradient(to right, green, green);"></div>	987	
AUX 2	<div style="width: 100%; height: 10px; background: linear-gradient(to right, lightgreen, lightgreen);"></div>	987	
AUX 3	<div style="width: 100%; height: 10px; background: linear-gradient(to right, yellowgreen, yellowgreen);"></div>	987	
AUX 4	<div style="width: 100%; height: 10px; background: linear-gradient(to right, yellow, yellow);"></div>	1500	
AUX 5	<div style="width: 100%; height: 10px; background: linear-gradient(to right, orange, orange);"></div>	1500	
AUX 6	<div style="width: 100%; height: 10px; background: linear-gradient(to right, brown, brown);"></div>	1500	
AUX 7	<div style="width: 100%; height: 10px; background: linear-gradient(to right, grey, grey);"></div>	1500	
AUX 8	<div style="width: 100%; height: 10px; background: linear-gradient(to right, darkgrey, darkgrey);"></div>	1500	
AUX 9	<div style="width: 100%; height: 10px; background: linear-gradient(to right, magenta, magenta);"></div>	1500	
AUX 10	<div style="width: 100%; height: 10px; background: linear-gradient(to right, purple, purple);"></div>	1500	

Channel Map  
 TAER1234

RSSI Channel  
 Disabled

Stick Low Threshold  
 1050

Stick Center  
 1500

Stick High Threshold  
 1900

RC Deadband  
 0

Yaw Deadband  
 0

3D Throttle Deadband  
 50

RC Interpolation  
 Auto

### Notes:



Please pay attention to the min Throttle of your transmitter, it should be less than the “Stick Low” , so that you can arm the Quadcopter (For Example 987 < 1050)

## 9. Arm/Disarm Lizard 105S Frsky BNF

1. The Default Arm/Disarm switch for Lizard 105S is AUX1(Channel 5),and you can also customize it with Betaflight Configurator. We also set the AUX2(Channel 6) for change flight mode and AUX3(Channel 7) for activate the buzzer which you can customize them too .

### Modes WIKI

Use ranges to define the switches on your transmitter and corresponding mode assignments. A receiver channel that gives a reading between a range min/max will activate the mode. Remember to save your settings using the Save button.

<b>ARM</b> <input type="button" value="Add Range"/>	AUX 1 ▾ Min: 1400 Max: 2100		<input type="button" value="X"/>
<b>AIR MODE</b> <input type="button" value="Add Range"/>	AUX 2 ▾ Min: 1525 Max: 2100		<input type="button" value="X"/>
<b>ANGLE</b> <input type="button" value="Add Range"/>	AUX 2 ▾ Min: 1175 Max: 1500		<input type="button" value="X"/>

2. Set Arm/Disarm switch for your TARANIS X9D: Move to the MIXER interface, Set "SA" or "SB" switch etc. for Ch5 to ARM/DISARM the motor. Suggest use a 3-steps switch to change flight mode.



3. Toggle the AUX1 Switch, the buzzer starts beeps one time and the Green LED on the flight controller turned off, this indicates the motor was armed. And also you can found "Armed" shows on your FPV Goggles or the FPV Monitor. Please make sure keep the Lizard105S level before arming. Be careful and enjoy your flight now!

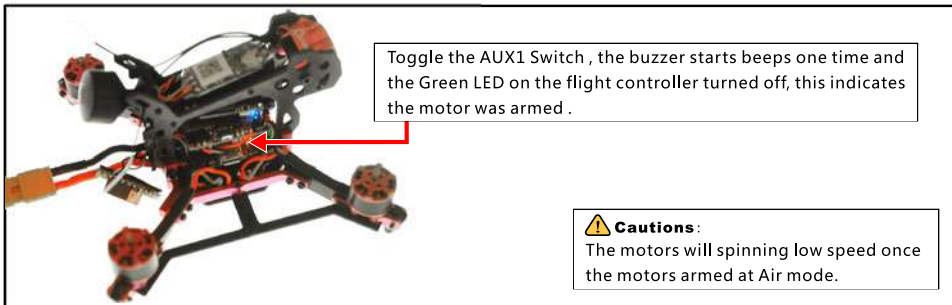

## 10. Lizard 105S Frsky BNF version receiver configuration

We have configured the frsky receiver before shipping. If you flashed the new firmware , please set up as the following steps: Enable Serial RX for UART3 , then choose Serial\_based receiver from the Receiver Mode tab ,and set the Serial Receiver Provider to SBUS Mode in Betaflight Configurator

Ports
WIKI

**Note:** not all combinations are valid. When the flight controller firmware detects this the serial port configuration will be reset.

**Note:** Do **NOT** disable MSP on the first serial port unless you know what you are doing. You may have to reflash and erase your configuration if you do.

Identifier	Configuration/MSP	Serial Rx	Telemetry Output	Sensor Input:	Peripherals
USB VCP	<input checked="" type="checkbox"/> 115200 ▾	<input type="checkbox"/>	Disabled ▾ AUTO ▾	Disabled ▾ AUTO ▾	Disabled ▾ AUTO ▾
UART1	<input type="checkbox"/> 115200 ▾	<input type="checkbox"/>	Disabled ▾ AUTO ▾	Disabled ▾ AUTO ▾	Disabled ▾ AUTO ▾
UART3	<input type="checkbox"/> 115200 ▾	<input checked="" type="checkbox"/>	Disabled ▾ AUTO ▾	Disabled ▾ AUTO ▾	Disabled ▾ AUTO ▾
UART6	<input type="checkbox"/> 115200 ▾	<input type="checkbox"/>	Disabled ▾ AUTO ▾	Disabled ▾ AUTO ▾	Disabled ▾ AUTO ▾

### Receiver

Serial-based receiver (SPEKSAT, S ▾) Receiver Mode

**Note:** Remember to configure a Serial Port (via Ports tab) and choose a Serial Receiver Provider when using RX\_SERIAL feature.

SBUS ▾ Serial Receiver Provider

## 11. Lizard 105S Flysky BNF Version binding procedure

1. Connect the battery to Lizard105S while holding the bind button on the Flysky receiver, the Green LED on the receiver will get to be blinking fast, this indicates the Lizard105S is ready to bind with the transmitter, then release the bind button.

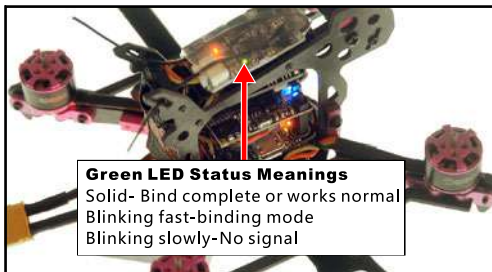
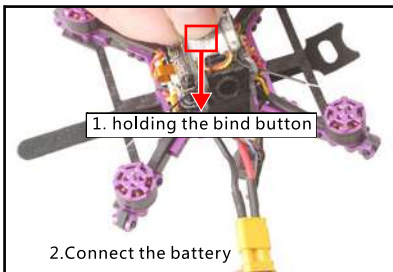

2. Please Ensure the RX setup of your transmitter is in AFHDS 2A Mode. Then get your transmitter into binding mode, Use Flysky I6 for an example: Turn on the transmitter while holding the bind button. The Green LED in the receiver will get to be solid, this indicates binding successfully.



3.The Default channel map for Lizard105S Flysky version is “AETR1234” , Please ensure your transmitter is matched with it ,otherwise it can't be armed.

Notes: Please pay attention to the min Throttle of your transmitter, it should be less than the “Stick low” , so that you can arm the Quadcopter (For Example  $1000 < 1050$ )

Receiver WIKI

Please read receiver chapter of the documentation. Configure serial port (if required), receiver mode (serial/ppm/pwm), provider (for serial receivers), bind receiver, set channel map, configure channel endpoints/range on TX so that all channels go from ~1000 to ~2000. Set midpoint (default 1500), trim channels to 1500, configure stick deadband, verify behaviour when TX is off or out of range.  
**IMPORTANT:** Before flying read failsafe chapter of documentation and configure failsafe.

Roll [A]	1501	Channel Map	RSSI Channel	
Pitch [E]	1499	AETR1234	Disabled	
Yaw [R]	1500	'Stick Low' Threshold	Stick Center	'Stick High' Threshold
Throttle [T]	1000	1050	1500	1900
AUX 1	1000	RC Deadband	Yaw Deadband	3D Throttle Deadband
AUX 2	1000	0	0	50
AUX 3	1000	RC Interpolation		
AUX 4	1500	Auto RC Interpolation		
AUX 5	1500			
AUX 6	1500			
AUX 7	1500			
AUX 8	1500			
AUX 9	1500			
AUX 10	1500			





## 12. Arm/Disarm Lizard 105S Flysky BNF Version

1.The Default Arm/Disarm switch for Lizard 105S is AUX1(Channel 5),and you can also customize it with Betaflight Configurator. We also set the AUX2(Channel 6) for change flight mode and AUX3(Channel 7) for activate the buzzer which you can customize them too .

### Modes WIKI

Use ranges to define the switches on your transmitter and corresponding mode assignments. A receiver channel that gives a reading between a range min/max will activate the mode. Remember to save your settings using the Save button.

<b>ARM</b> <a href="#">Add Range</a>	AUX 1 ▾		✕
<b>AIR MODE</b> <a href="#">Add Range</a>	AUX 2 ▾		✕
<b>ANGLE</b> <a href="#">Add Range</a>	AUX 2 ▾		✕

2. Set Arm/Disarm switch for your Flysky Radio: Move to the Aux.channels interface, Set "SWA" or "SWB" or "SWC" switch etc. for Ch5 to ARM/DISARM the motor. Suggest use a 3-steps switch (like "SWC" of the Flysky I6) to change flight mode .



3. Toggle the AUX1 Switch , the buzzer starts beeps one time and the Green LED on the flight controller turned off, this indicates the motor was armed . And also you can found "Armed" shows on your FPV Goggles or the FPV Monitor. Please make sure keep the Lizard105S level before arming .Be careful and enjoy your flight now !

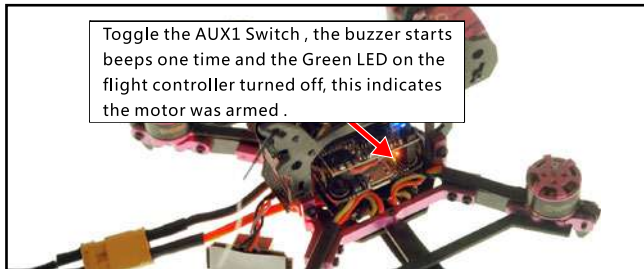

### 13. Lizard 105S Flysky version receiver configuration

We have configured the Flysky receiver before shipping. If you flashed the new firmware , please set up as the following steps: Enable Serial RX for UART3 , then choose Serial\_based receiver from the Receiver Mode tab ,and set the Serial Receiver Provider to IBUS Mode in Betaflight Configurator

Ports
WIKI

**Note:** not all combinations are valid. When the flight controller firmware detects this the serial port configuration will be reset.  
**Note:** Do **NOT** disable MSP on the first serial port unless you know what you are doing. You may have to reflash and erase your configuration if you do.

Identifier	Configuration/MSP	Serial Rx	Telemetry Output	Sensor Input	Peripherals
USB VCP	<input checked="" type="checkbox"/> 115200 ▾	<input type="checkbox"/>	Disabled ▾ AUTO ▾	Disabled ▾ AUTO ▾	Disabled ▾ AUTO ▾
UART1	<input type="checkbox"/> 115200 ▾	<input type="checkbox"/>	Disabled ▾ AUTO ▾	Disabled ▾ AUTO ▾	Disabled ▾ AUTO ▾
UART3	<input type="checkbox"/> 115200 ▾	<input checked="" type="checkbox"/>	Disabled ▾ AUTO ▾	Disabled ▾ AUTO ▾	Disabled ▾ AUTO ▾
UART6	<input type="checkbox"/> 115200 ▾	<input type="checkbox"/>	Disabled ▾ AUTO ▾	Disabled ▾ AUTO ▾	Disabled ▾ AUTO ▾

#### Receiver

Serial-based receiver (SPEKSAT, S ▾) Receiver Mode

**Note:** Remember to configure a Serial Port (via Ports tab) and choose a Serial Receiver Provider when using RX\_SERIAL feature.

IBUS ▾ Serial Receiver Provider

#### 14. Lizard 105S DSM2/DSMX BNF Version binding procedure and Satellite receiver setup

The Lizard 105S DSM2/X version comes with a BM01 binding module, the binding step is:

1. First remove the Receiver from Lizard 105S
2. Connect the binding module and the receiver of the Lizard 105S
3. For the DSMX Protocol Transmitter like DX9/DX8/DX7S/DX6, please just plug the USB of the binding module to computer or 5V power bank, the orange LED on the receiver will blinking fast, this indicates the receiver is in the DSMX protocol bind mode, turn on your transmitter and enter into binding mode, the orange LED should be solid once binding successful. If failed, please Repeat the above steps

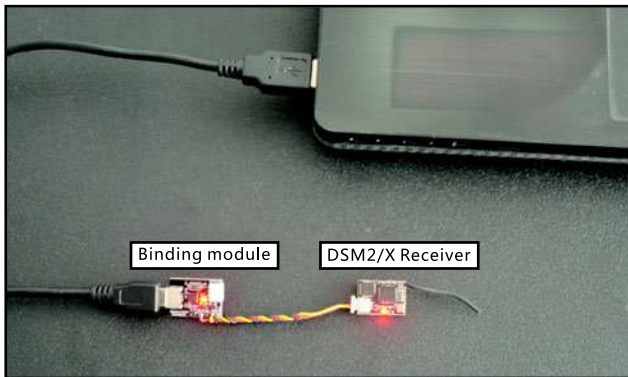

4. For the DSM2 Protocol Transmitter like DX7/DX6I, please plug the USB of the binding module to computer or 5V power bank while holding the button, the orange LED on the receiver will blinking fast, this indicates the receiver is in the DSM2 protocol bind mode, then release the button and turn on your transmitter and enter into binding mode, the orange LED should be solid once binding successful. If failed ,please Repeat the above steps

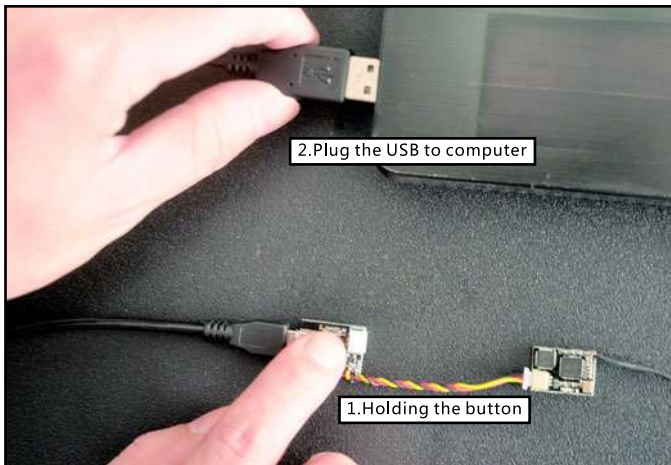

5.Reconnect the receiver to Lizard 105S after binding successfully

6.The Default channel map for Lizard 105S DSMX version is "TAER1234" , Please ensure your transmitter is matched with it ,otherwise it can't be armed.

Notes: Please pay attention to the min Throttle of your transmitter, it should be less than the "Stick min" , so that you can arm the Quadcopter (For Example  $1048 < 1050$ )

Receiver WIKI

Please read receiver chapter of the documentation. Configure serial port (if required), receiver mode (serial/ppm/pwm), provider (for serial receivers), bind receiver, set channel map, configure channel endpoints/range on TX so that all channels go from -1000 to -2000. Set midpoint (default 1500), trim channels to 1500, configure stick deadband, verify behaviour when TX is off or out of range.  
**IMPORTANT:** Before flying read failsafe chapter of documentation and configure failsafe.

Roll [A]	<input type="text" value="1500"/>
Pitch [E]	<input type="text" value="1497"/>
Yaw [R]	<input type="text" value="1502"/>
<b>Throttle [T]</b>	<input type="text" value="1048"/>
AUX 1	<input type="text" value="1159"/>
AUX 2	<input type="text" value="1159"/>
AUX 3	<input type="text" value="1159"/>
AUX 4	<input type="text" value="1159"/>
AUX 5	<input type="text" value="1159"/>
AUX 6	<input type="text" value="1500"/>
AUX 7	<input type="text" value="1500"/>
AUX 8	<input type="text" value="1500"/>

Channel Map	TAER1234	RSSI Channel	Disabled
Stick Low Threshold	<input type="text" value="1050"/>	Stick Center	<input type="text" value="1500"/>
	<input type="text" value="1900"/>	Stick High Threshold	<input type="text" value="1900"/>
RC Deadband	<input type="text" value="0"/>	Yaw Deadband	<input type="text" value="0"/>
	<input type="text" value="50"/>	3D Throttle Deadband	<input type="text" value="50"/>
RC Interpolation	Auto RC Interpolation		

## 15. Arm/Disarm Lizard 105S DSM2/DSMX BNF version

1. The Default Arm/Disarm switch for Lizard 105S DSM2/DSMX BNF Version is AUX1(Channel 5), for most of Spektrum radio the default channel 5 is Gear switch and you can also customize it with Betaflight Configurator. We also set the AUX2(Channel 6) for change flight mode and AUX3(Channel 7) for activate the buzzer which you can customize them too. Suggest use a 3-steps switch to change flight mode.

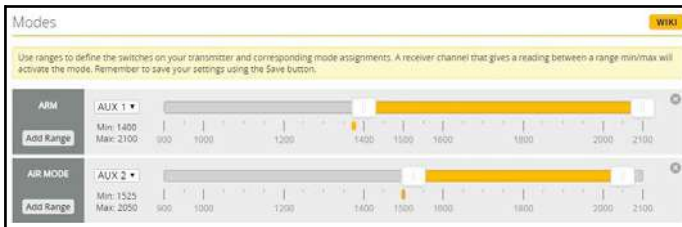

2. Turn on the transmitter and set a switch for Ch5 to ARM/DISARM the motor, some transmitter ink SPECKTRUM DX6/DX6I, the default Ch5 is GEAR Switch.

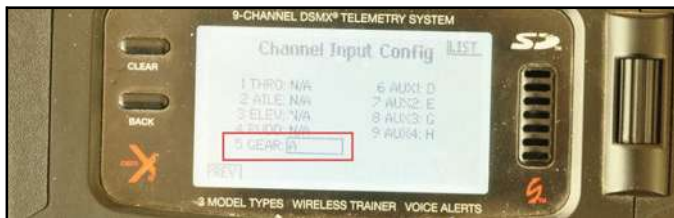

3. Toggle the AUX1 Switch , the buzzer starts beeps one time and the Green LED on the flight controller turned off, this indicates the motor was armed . And also you can found "Armed" shows on your FPV Goggles or the FPV Monitor. Please make sure keep the Lizard105S level before arming .Be careful and enjoy your flight now !

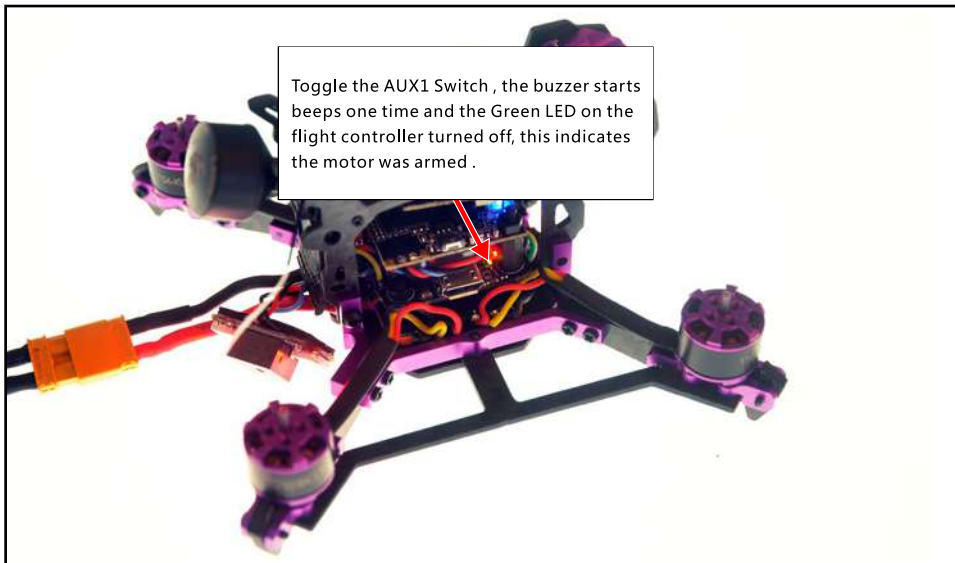



## 16. Lizard 105S DSM2/DSMX BNF version receiver configuration

We have configured the DSM2/DSMX before shipping. If you flashed the new firmware , please set up as the following steps: Enable Serial RX for UART3 , then choose Serial\_based receiver from the Receiver Mode tab ,and set the Serial Receiver Provider to SPEKTRUM2048 for DSMX Protocol and SPEKTRUM1024 for DSM2 Protocol in Betaflight Configurator

Ports
WIKI

**Note:** not all combinations are valid. When the flight controller firmware detects this the serial port configuration will be reset.

**Note:** Do **NOT** disable MSP on the first serial port unless you know what you are doing. You may have to reflash and erase your configuration if you do.

Identifier	Configuration/MSP	Serial Rx	Telemetry Output	Sensor Input	Peripherals
USB VCP	<input checked="" type="checkbox"/> 115200 ▾	<input type="checkbox"/>	Disabled ▾ AUTO ▾	Disabled ▾ AUTO ▾	Disabled ▾ AUTO ▾
UART1	<input type="checkbox"/> 115200 ▾	<input type="checkbox"/>	Disabled ▾ AUTO ▾	Disabled ▾ AUTO ▾	Disabled ▾ AUTO ▾
UART3	<input type="checkbox"/> 115200 ▾	<input checked="" type="checkbox"/>	Disabled ▾ AUTO ▾	Disabled ▾ AUTO ▾	Disabled ▾ AUTO ▾
UART6	<input type="checkbox"/> 115200 ▾	<input type="checkbox"/>	Disabled ▾ AUTO ▾	Disabled ▾ AUTO ▾	Disabled ▾ AUTO ▾

### Receiver

Serial-based receiver (SPEKSAT, S ▾) Receiver Mode

**Note:** Remember to configure a Serial Port (via Ports tab) and choose a Serial Receiver Provider when using RX\_SERIAL feature.

SPEKTRUM2048

▾

Serial Receiver Provider

SPEKTRUM1024

→ SPEKTRUM1024 for DSM2

SPEKTRUM2048

## 17. OSD configuration

1. Connect the Lizard 105S to the computer , open Betaflight Configurator , move to the OSD option, then you can configure the layout of the OSD.



2. OSD change font layout



## 18. Flight controller firmware update

Firmware update:

- 1.Install latest STM32 Virtual COM Port Driver <http://www.st.com/web/en/catalog/tools/PF2579382>
- 2.Install STM BOOTLOAD Driver (STM Device in DFU MODE)
- 3.Open Betaflight configurator and choose firmware target "OMNIBUS F4SD", then select the firmware version.
- 4.There are 2 ways to get in DFU Mode: 1).solder the boot pad and then plug USB to comuper 2).loading betaflight firmware and hit "flash", then it will getting into DFU Mode automatically.
- 5.Open Zadig tools to replace the drivers from STM32 Bootloader to WINUSB Driver .

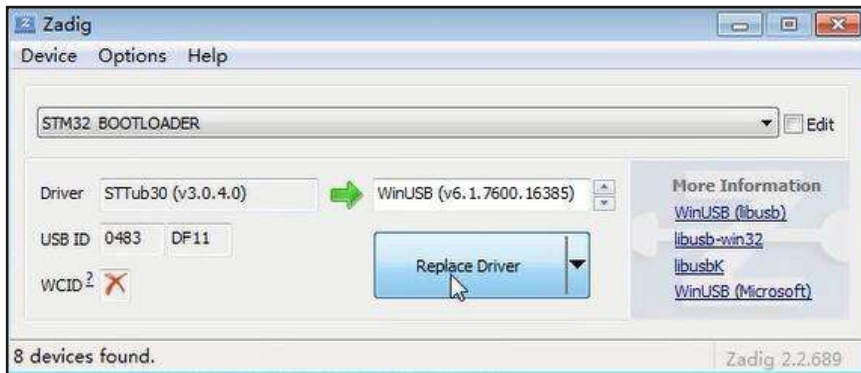

- 6.Reconnect the flight controller to the computer after done the driver replacement, and open Betaflight configurator, loading firmware and click flash.



[www.eachine.com](http://www.eachine.com)

---

\*User manual is subject to change without prior notice.