



FIMI MINI 3 User Manual

Please read the user manual carefully before using and keep the manual for future reference

Services & Support

FIMI provides FIMI MINI 3 users with tutorial videos and the following information:

1. 《FIMI MINI 3 User Manual》
2. 《FIMI MINI 3 Quick Start Manual》
3. 《FIMI MINI 3 Disclaimer and Safety Operation Instructions》

Users are advised to watch tutorial videos before using the product and read FIMI MINI 3 Disclaimer and Safety Operation Instructions carefully and get to know the process of using by going through FIMI MINI 3 Quick Start Manual.

For more detailed product information, please refer to FIMI MINI 3 User Manual.

Please download the firmware on the link below : <https://www.fimi.com>

4. Please scan the the following QR-code to download FIMI Navi Mini App



Product Introduction

FIMI MINI 3 is a highly integrated foldable mini quadcopter featuring long endurance, strong wind resistance, and a lightweight body weighing 250g. With a high-precision three-axis mechanical stabilization gimbal and high-speed image processing chip, it captures stable and smooth 4K 60fps footage. It offers high-definition real-time video transmission, enabling long-distance flights without worry. Paired with a remote controller, it's easy to carry and operate. The app interface is simple and user-friendly, with added AI super night video and 8K time-lapse recording functions, simplifying operation for a more enjoyable user experience.

Package List



Aircraft



Remote controller



Battery



Spare Propellers



Screwdriver



Gimbal Cover

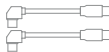

Cable



Instruction



Screws



USB-Cable

Product Overview

1 Drone

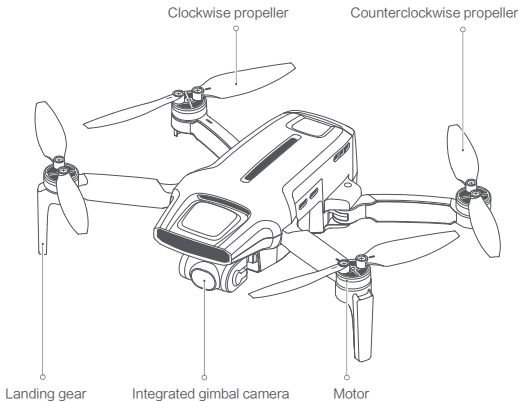

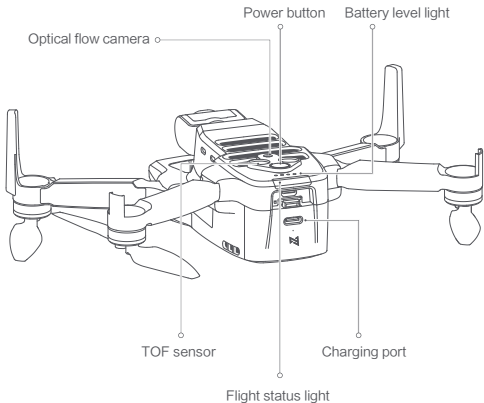

2 Remote controller

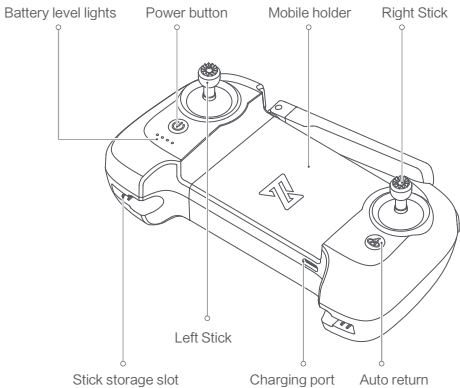

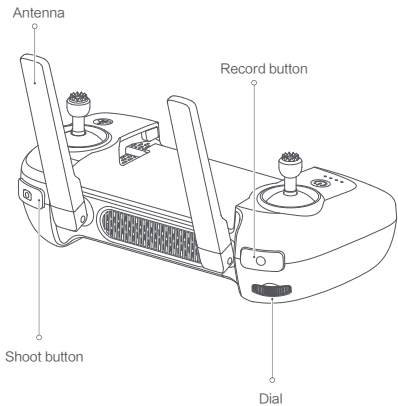

Controller Functions

	Buttons	Function description
1	Left stick	Push stick forward to ascend Pull stick backward to descend Move stick left & right to Yaw CCW Move sick right to Yaw CW
2	Right stick	Push stick forward to Pitch (fly) drone forward Pull stick backwards to Pitch (fly) drone backwards Move stick left to Roll (fly) drone left Move stick right to Roll (fly) drone right
3	RTH (Return to Home)	Long press the button for over 2 seconds, and the drone will enter RTH mode when you hear a beep. Short press the button to cancel RTH mode
4	Photo button	Short press to shoot the picture
5	Video button	Short press to start / stop recording
6	Dial	Adjust the pitch angle of gimbal camera
7	Power button	Short press to view the battery level Short press+long press 2 seconds to power on/off

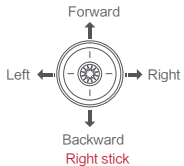
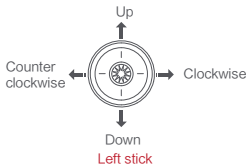
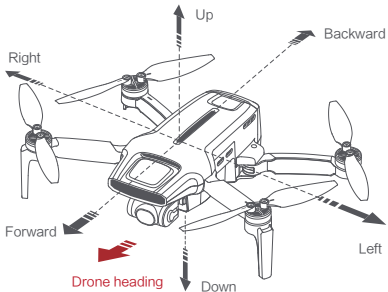

Note: The stick mode can be set in FIMI Navi Mini app. (The default is Mode 2)

Drone

Flight Mode:

GPS Mode

To achieve precise hovering, the drone is equipped with a GPS module. The intelligent flight function works in GPS mode. Users can enable Sport Mode or Beginner Mode in the flight settings. When the Beginner Mode is on, the flight speed, flight distance, flight altitude and RTH altitude will be limited. In sport mode, the maximum flight speed is 18m/s, the maximum ascending speed is 5m/s, and the maximum descending speed is 3.5m/s.

VPU Mode (Vision Processing Unit Mode)

An Optical Flow module is also built into the drone for precise hovering and landing at the home point. In VPU mode, the intelligent flight function is not supported. The maximum flight speed is 10m/s (36 km/h), the maximum ascending speed is 3m/s (11 km/h), and the maximum descending speed is 2m/s (7 km/h). When the drone is flying above a well-lit ground with a clear texture and the GPS signal is poor, it will switch automatically to VPU mode.

ATTI Mode (Altitude Mode)

When the aircraft enters the ATTI mode under weak GPS or optical flow signals, the maximum flight speed is 18m/s, the maximum ascent speed is 5m/s, and the maximum descent speed is 3.5m/s. In ATTI mode, the aircraft may drift in the horizontal direction and does not support intelligent flight functions. Therefore, to avoid accidents, users should choose locations with good GPS signals and open space for flying. Once the aircraft enters ATTI mode, please land it as soon as possible to a safe location.

Note: Above 2400 meters altitude, the flight mode will become ineffective.

Drone Lights

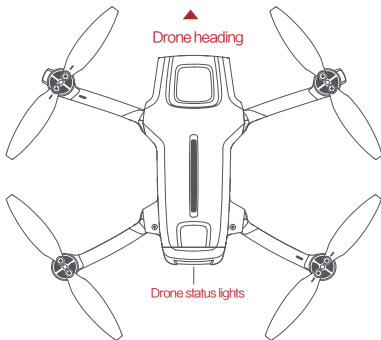

Drone light

	Light status	Drone status
1	The yellow light is fading in and out	Self-checking
2	Red light on	Drone on the ground: Self-check fails
		Drone is flying: Attitude Mode

3	Red and yellow lights flash alternately	Calibrate the compass
4	Green light flashing twice	Ready to fly/in flight
5	Red light flashing twice	Low battery alerts
6	Red light flashing quickly	Very low battery alerts, land as soon as possible
7	Red and green lights flash alternately	Updating firmware
8	All lights off	The drone is paring to the RC

Safety Protection

Failsafe Return

Failsafe return is only supported in GPS mode. When the drone and remote controller signal is interrupted for more than 2 seconds, the flight control system built into the drone will take over the control of your drone, plan the return path according to the original flight path, then the drone will fly back and land at the home point. This function works precisely if enough GPS satellites are locked, the compass has no interference and the home point has been recorded correctly. If the wireless signal reconnects during the failsafe return, the pilot can short press the RTH button to cancel, and the drone will hover at the current position.

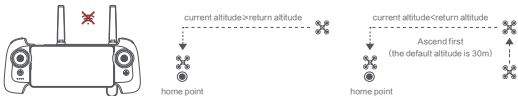

Low-power Protection

In flight, when the battery level is only enough for RTH, App advises users to return, and the drone will return automatically after 10 seconds countdown. When the battery level is only enough for landing, App advises users to land as soon as possible, and the drone will land automatically after 10 seconds countdown. When the battery level is at 15% usage left, the drone will be forced to land.

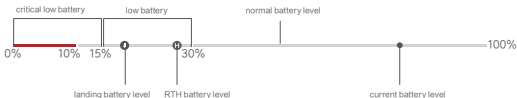

Hovering on the Edge of No-fly-zone

The drone will automatically hover in the restricted flight area designated by the state, such as the edge of airports, and the App will appear corresponding hints. The user can use sticks to fly the drone from the edge of the no-fly-zone, but the drone will not enter the no-fly-zone.



Intelligent Flight

Auto Take-off

When the conditions are right, tap the auto take-off icon on the left side of the APP interface. In GPS mode, the drone will take off to an altitude of 4 meters and hover for sticks control. In VPU mode, the drone will take off to an altitude of 1.2 meters and hover for sticks control.

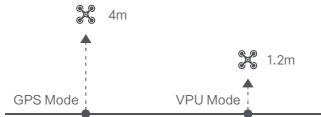

Auto Landing

When the conditions are right, tap the auto landing icon on the left side of the APP interface.

Note: Users can short press the RTH button to exit intelligent flight.

Auto Return

When the drone is in flight, the user can long press the auto return button to return the drone. When the return distance is less than 10 meters and flight altitude is less than 3 meters, the drone will ascend to 3 meters first and return to the home point; if the flight altitude is greater than or equal to 3 meters, the drone will directly return to the home point.

When the return distance of the drone is greater than or equal to 10 meters and the flight altitude is less than 30 meters, the drone will ascend to 30 meters and return to the home point; if the flight altitude is 30 meters or more, the drone will directly return to the home point. The user can press the Auto Return button or tap the APP to the left to exit.

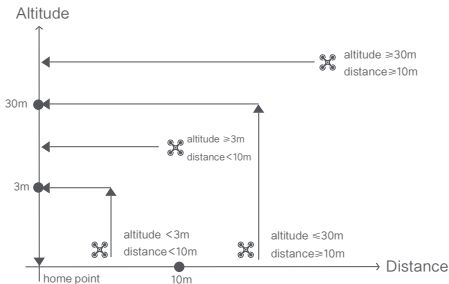

Smart Track

Smart Track is supported only in GPS mode. The user can choose Trace, Profile, or Lock in the App menu. The drone will trace the subject chosen at the App interface at a distance.

In Trace mode, the heading will always lock at the target and trace it from the back at a distance.



In Profile mode, the heading will always lock at the target and trace it from the side at a distance.

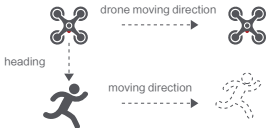

In Lock mode, the drone will hover at a place if flight speed is 0, following the target 360°. The user can also adjust flight speed, and the drone will fly around the target at a certain distance.

flight speed = 0m/s

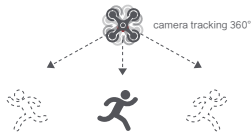

flight speed = 0m/s

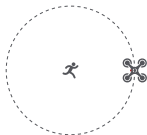

Note: In Smart Trace, users should always make sure to avoid people, animals and obstacles in the tracking path to ensure the flight safety. Users should comply with local laws and regulations when using the function.

Spiral flight

The user selects spiral flight on app, set the center point and radius. The drone will fly around the center point at a default speed. If the user sets a POI, the drone will lock and shoot the POI. Fly away from the central point to set radius. Set flight speed, move direction and heading. If the heading is free, the user can drag a rectangle around a POI

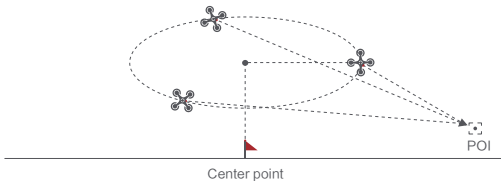

If sticks are moved in flight, the flight altitude or radius will be changed.
 Taking Mode 2 as example:



Tap-fly

The user can select Tap-fly in the App. Tap map to choose a destination and set flight speed, the drone will fly over there at a default speed in a straight line. If a point of interest is set, the camera will be locked at the POI

- Tap the map to choose a destination
- Switch to image interface to drag a rectangle around the POI
- Set flight altitude and speed

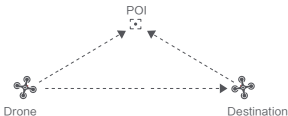

Course Lock

The user can select Course Lock mode in the App. The drone saves current fly direction as heading. The user can control sticks to adjust direction of head and gimbal, but the forward direction remains unchanged.

Tripod Mode

The max speed of the drone is 1m/s, and the max rotation speed is 60°/s. In Tripod Mode, operation sensitivity is lowered simultaneously to shoot more stable and smooth video.

Aerial Mode

The brake distance is lengthened and the angular speed of rotation is limited to make sure the shooting videos are more stable and smooth

Note: Course Lock is enabled in Aerial Mode, Users can turn it on in the APP

Spiral Mode

The user can select Spiral Mode in the App. Set the central point and radius, the drone will spirally fly upward and shoot a video simultaneously, showing a sense of space.

- Fly to a point to set as the central point.
- Fly away the central point to set radius.
- Set spiral direction and flight distance to start and shoot a video at the same time.
- The mission interrupted if the user moves sticks.

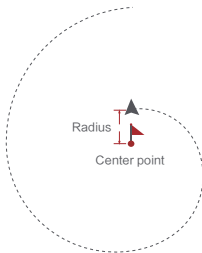

One-click Video

- Soaring flight: Select a target and the drone will rise quickly according to the set altitude, and shoot a video.
- Dronie flight: Select a shooting target, the aircraft will automatically rise and fly far away according to the set distance and current gimbal angle, and shoot a video.
- Orbit flight: Select the target, the aircraft will keep the current altitude, take the horizontal distance from the target as the radius, circle the target, and shoot a video.
- Spiral flight: Select the shooting target, the aircraft will take the top of the target as the center, and the horizontal distance from the target as the radius of the inner circle, according to the set radius difference, to spiral around the center point for a uniform speed and shoot a video.

One-tap Edit

1. One-tap edit video material as a 15-second short video. 5 templates and filters are available.
2. Save the edited video.
3. Share the work to Youtube, Facebook and Twitter.

Waypoint

Choosing waypoint and drawing route both are available at map. The drone flies along waypoint route at a default speed. If a point of interest is set, the camera will be locked at the POI. The user can select a way to set waypoints, including choosing points in flight or on the map, historical routes.

Choosing points in flight:

1. Control the drone to a point to set as a waypoint.
2. Using sticks to set flight altitude and heading direction, dials to set gimbal angle, and actions when reaching the waypoint.

3. When all waypoints ready, please set waypoints routes attribute, including flight speed, heading direction, action at the destination.
4. POI is enabled when executing waypoints.

Choosing points on the map

1. Tap map to add waypoint.
2. Set waypoint attribute, including flight altitude and action at the destination.
3. Drag the POI icon to the map, and set its altitude and relate waypoints.
4. when all waypoints ready, please set flight speed, failsafe action, and action at the destination.
5. POI is enabled when executing waypoints.

Historical routes

1. Preview the waypoints and its attribute on "Favorite" after entering the "History" list.
2. Tap to start and show the real-time waypoints trace.
3. The drone fly as the historical route after taking off.

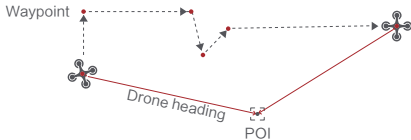

SAR Mode

The user can select SAR Mode in the APP. With real-time GPS coordinates, the drone could help user to search and rescue.

Image interface: show real-time coordinate and time of the drone, support digital zoom, screen shots to share it online

Map interface: show real-time coordinate and time of the drone in ordinary map and satellite map, screen shots to share it online

Precise Landing

In the process of Return to Home, the optical flow sensor will match landing pad features above the home point. Once matched successfully, the drone will land on the landing pad precisely.

Note: Please enable precise landing in the app before use it.

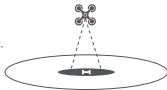

Fix-wing Mode

In Fix-wing Mode, the drone can only fly forward, not backward. The user can use sticks to control flight speed and course as showed below (Mode 2).

Left stick	push upward	up
	Push downward	down
	toggle left	turn left
	toggle right	turn right
Right stick	push upward	accelerate
	push downward	decelerate
	toggle left	turn left
	toggle right	turn right

AI Super Night Video

The FIMI MINI 3 is equipped with a brand-new generation of AI ISP, and the Super Night Mode has undergone a revolutionary upgrade. With ultra-high sensitivity noise reduction, the signal-to-noise ratio has increased by 4 times, capturing pure and bright images in low-light environments at night. Under automatic mode, it supports a maximum ISO sensitivity of 25600.

- In camera video mode, click on the shooting mode options and select Super Night Mode.

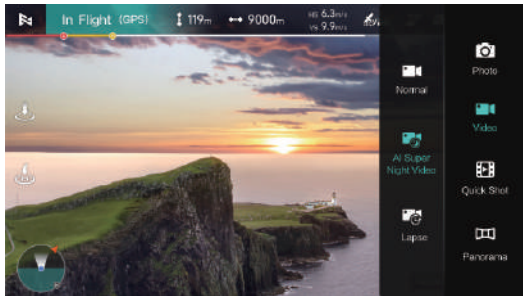

- In manual mode, if the APP does not prompt to switch to night mode, please manually switch based on the current ambient brightness.



Notes:

1. Night mode currently supports 24/25/30fps specifications.
2. Night mode does not support zoom.

8K Hyperlapse Recording

Supports a maximum resolution of 8000X6000 ultra-high-definition images. Lower the preview frame rate for better time-lapse recording. For optimal time-lapse recording, fly at a slower speed.

- In camera video mode, click on the shooting mode options and select Hyperlapse Recording.

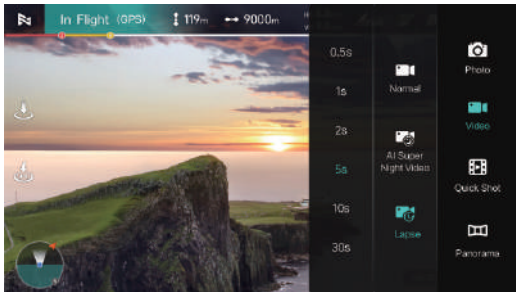

- Access the video size options through settings or the resolution settings below.



- Select 8K Hyperlapse Recording.

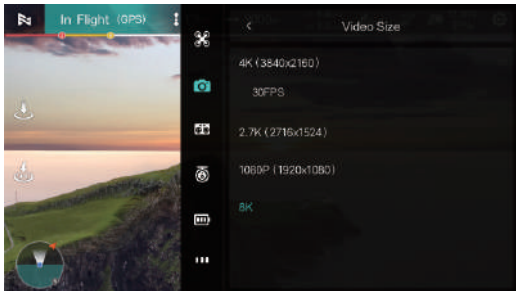

Notes:

1. It is recommended to fly at an altitude of 50m or above to capture time-lapse footage for better results.
2. Select static objects at a distance of >15m, such as buildings, mountains, houses, etc.
3. Avoid selecting close-up ground, people, moving vehicles, etc.
4. 8K Hyperlapse Recording does not support Super Night Mode.
5. 8K Hyperlapse Recording does not support zoom.
6. 8K Hyperlapse Recording does not support portrait orientation.

Propellers

- Please install and remove propellers as the picture shown.
- Attach the gray marked propellers to the motor mounting base with gray marks on the arms.
- Distinguish clockwise propellers and counterclockwise propellers before installation.
- Need to use a screwdriver for installation and make sure screws are locked well.

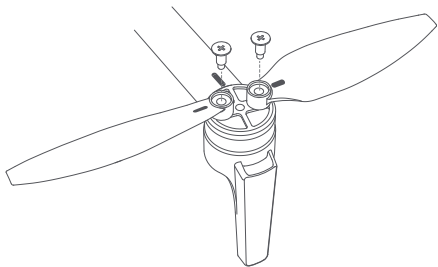

Battery

- Hardly push the battery, after the battery installed in place, there will be a "click" sound.
- To remove the battery, you need to press the bottom buckle to pull out the battery.

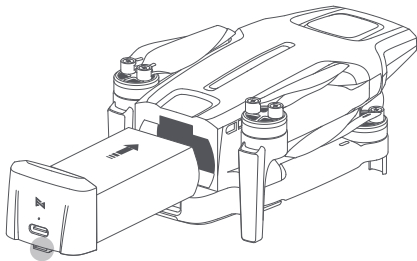

Battery buckle

Safety tips: Please place the battery separately if don't use it for a long time.

Charging

- Use the USB cable to charge the battery as shown below.
- The battery status light keeps on when charging.
- The battery level light off when charging finished.
- It takes 2.5h to fully charge the battery via 5V/2A, 1.5h via 9V/2A and 1h via 9V/3A.

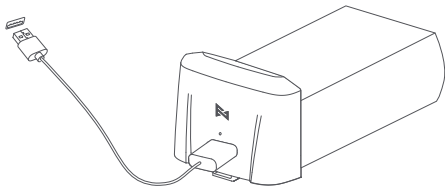

Note:

1. The power of charger affects the charging time. For ensuring the charging time, please use charger with protocol of QC2.0 and above. PD protocol fast charging is not supported.
2. Charging temperature ranges from 5°C~40°C. The battery can't be charged if temperature higher or below this range

Turning on and off

- Short press+long press power button 2 seconds to power on/off .
- Short press the power button to check battery level.

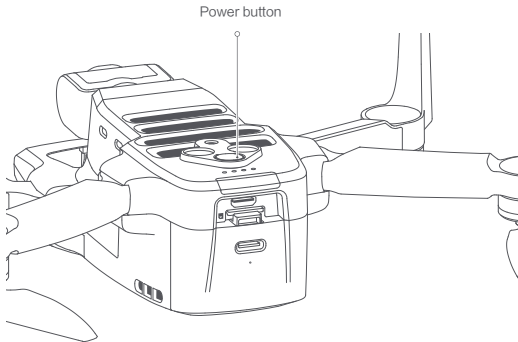

Insert Micro SD card

- When installing Micro SD card, please pull out the battery.
- Insert the SD card into the SD card slot.
- When removing SD card, press the SD card to pop out.

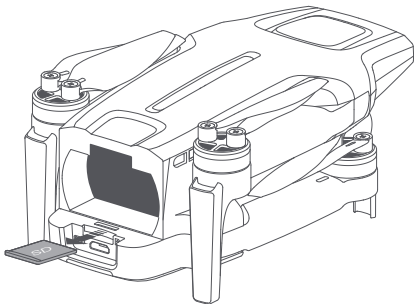

Equip and remove the gimbal protector

- Equip and remove the gimbal protector as shown

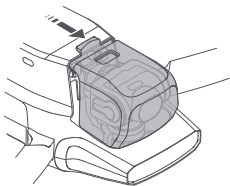

Equip the gimbal protector as
the arrow leading

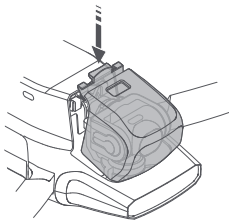

Remove the gimbal protector as
the arrow leading

Gimbal

The FIMI MINI 3 drone is equipped with a newly designed integrated gimbal camera, utilizing three-axis mechanical stabilization technology to provide a stable shooting platform for the camera. The pitch axis can be controlled within a range of 10 to -90 degrees, which can be adjusted either through the left wheel on the remote controller or within the app interface. The camera features a CMOS sensor size of 1/2 inch, with a resolution of up to 48 million effective pixels. It comes with an undistorted lens with an equivalent focal length of 24mm, making it easier to capture large scenes.

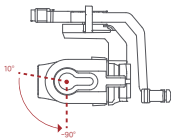

Working Mode

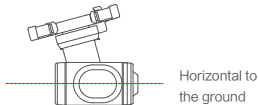

Follow:
The angle between the gimbal's orientation and aircraft front remains constant at all times.

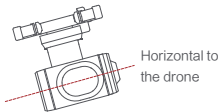

FPV mode:
The gimbal synchronizes with the movement of the aircraft to provide a first-person flying experience.

Remote controller

1 Turning on and off

- Short press+long press power button 2 seconds to power on/off.
- Short press to check battery level.

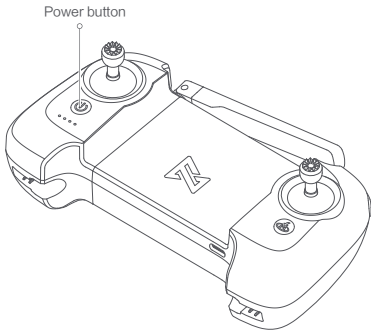

2 Charging

- Connect the remote controller to a power adapter as shown below.
- When the RC is in charge, the battery level lights are flashing.
- When the RC is fully charged, the battery level lights go out.
- It takes about 2.5 hours to fully charge the RC in the powered off condition.

5V \equiv 2A

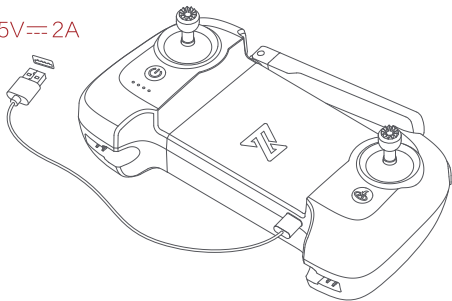

3 Connect the remote controller

- Use USB cable to connect the device as shown.
- Unfold the RC to place the device.

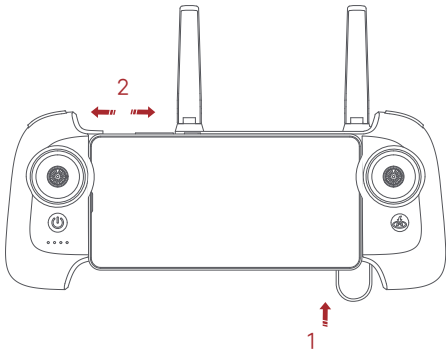

4 Taking Videos & Photos

- Press the shoot button to take a photo. A photo is taken when you hear 2 short sounds.
- Press the record button to record video. Press again to stop recording with 4 short sounds.
- The pitch angle of the gimbal can be controlled by toggling the left dial up and down.

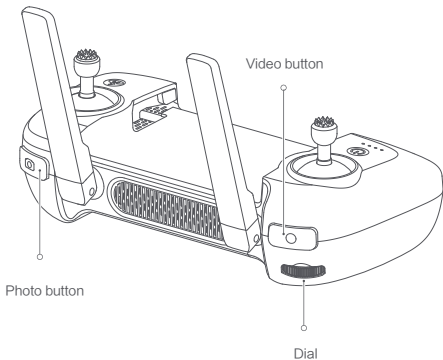

5 Sticks Control

(Mode 1)

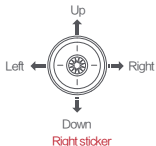
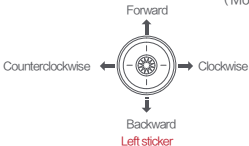

(Mode 2)

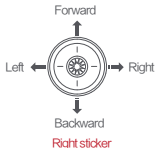
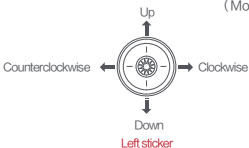

(Mode 3)

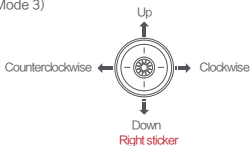
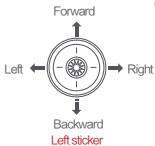

Remote Controller Pairing

When a new remote controller or drone is replaced, please pair the remote controller and the drone again as shown below:

- Turn on the drone and remote controller.
- Wait for 20 seconds, then long press the power button of controller until hearing the beep sound, and the light will be flashing.
- Long press the power button of the drone till the tail light off.
- The code pairing succeeds when the power button on the RC turns white and the tail light on the drone keeps on.

Long press the power button.

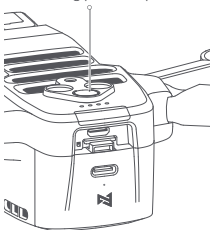

Long press the power button.

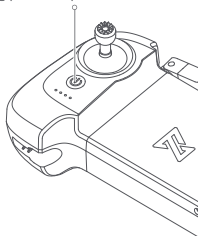





















Note:

1. Please ensure the drone and the RC stay within 0.5m while pairing.
2. Ensure the battery level of drone and RC are more than 30%.
3. The time for the Pairing process is usually in the range of 10s-60s, please wait patiently

Light status of remote controller

Remote lights	Remote status
Short press the power button	Check battery level
Fade in and out	Not connected to the drone
Flash in turn	Pairing or updating the firmware
Light keeps on	Connection normal

LED1	LED2	LED3	LED4	Battery level
				$75\% < \text{Battery level} \leq 100\%$
				$50\% < \text{Battery level} \leq 74\%$
				$25\% < \text{Battery level} \leq 49\%$
				$10\% < \text{Battery level} \leq 24\%$
				The remote controller beeps to warn that the battery level is less than 10%.

APP

Download and install Fimi Navi Mini app, register a FIMI user account or enter the app directly.

Note: You are supposed to register and log in for enjoying more special flight modes.

Image Interface



1. Return to login interface

 : Tap to return to the home screen.

2. Real-time parameter

In Flight: Show the real-time status of the drone.

 : Height from the home point.

 : Distance from the home point.

 : Vertical speed of aircraft.

 : Horizontal speed of aircraft.

 : Battery level is only enough for landing.

3.Signal status, battery status and default settings

 : Display the current GPS signals. 0-6 means low signal and displays in red colour, 7-12 medium signal and in yellow colour, more than 13 great signal and in white colour.

 : Display RC signal. Tap to enter the RC setting.

 : Display real-time battery level. Tap to enter battery setting.

 : Tap to enter setting.

4.Camera

 : Switch camera mode.

 : Tap to start recording video.











 : Tap to start shooting photos.

 : Tap to shoot one-tap video.





 : Tap to choose from photo mode, video mode, one-tap video and smart flight mode.

 : Tap to preview captured photos and videos.

5.Smart flight

-  : Switch various switch modes from waypoint mode, spiral mode, route mode, tripod mode and so on.
-  : Flight planning mode includes setting POI, flight route and historical route.
-  : Smart tracking includes trace tracking, profile tracking and lock tracking.
-  : Spiral flight.
-  : Waypoint flight.
-  : SAR mode.
-  : Aerial mode.
-  : Tripod mode.
-  : Flight direction locked.
-  : Fixed wing.
-  : Time-lapse mode

6.Gimbal and image parameter

-  : Show remaining and total storage of SD card.
-  : Camera parameter settings, tap to set EV,ISO,shutter,video or photo mode, resolution, video size, white balance, etc.
-  : Tap to show shutter parameter.
-  : Tap to show ISO parameter.
-  : Tap to show EV parameter.

 : Display the current pitch angle of the gimbal, Long press the gimbal for more than 2 seconds to vertically downward, double-click the gimbal to return to center

 : In video mode, quick toggle for AI Super Night Mode.









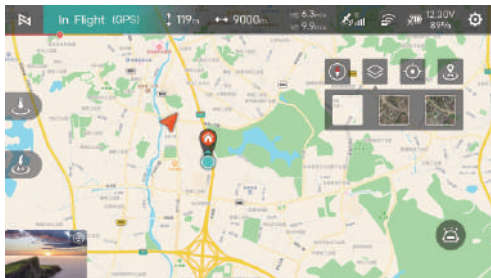



7. Light metering and locked exposure

Tap any position on the app to meter the light or lock the exposure value.



8. Map: Display the location of drone. Switch interfaces from specific map, orientation ball and guided map.

Interface of map:



-  : Tap to center the drone.
-  : Display the location of the drone.
-  : Display the location of the Home.
-  : Display the location of the phone.
-  : Tap to correct the direction.
-  : Switch the map.
-  : Home point.
-  : Tap to switch to guided map.
 -  : Represent the direction of the phone.
 -  : The position of drone to the phone. And the direction of the drone.
 -  : Compass.
 -  : Blue area means the orientation of the drone.

9.Shortcuts

-  : Tap to auto takeoff.
-  : Tap to auto land the drone.
-  : Tap to return the drone.

Flight

Distinguish the direction of the drone

- The side of gimbal camera is head of drone.
- Distinguish the direction of drone through status light.

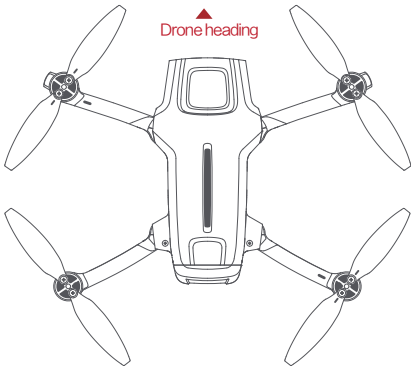

Safety tips: User should face to the tail of drone when operating it, in case of accident caused by wrong direction.

Prepare to fly

- Make sure that the battery of the aircraft and remote controller is sufficient.
- Make sure that the propeller is properly installed and free from damage and aging.
- Make sure the gimbal protective cover has been removed and the camera lens has been cleaned.
- Make sure that the SD card is inserted.

Manual takeoff/landing

- Keep both sticks to the bottom inner still over 3 seconds, the propellers start spinning.
- Release both sticks once propellers spinning, and firmly push the left stick upward to take off the drone.
- When the drone in flight, release the sticks and the drone will hover automatically.

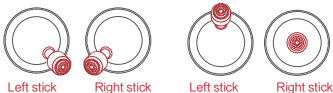

- Slowly move the left stick downward to land the drone.
- Once the drone landed, push and hold the left stick down over 5 seconds, the motors will stop.



Safety tips: The drone has no waterproof function. Please be careful of landing environment. Do not land on an inclined plane for safety.

Basic Flight Operations

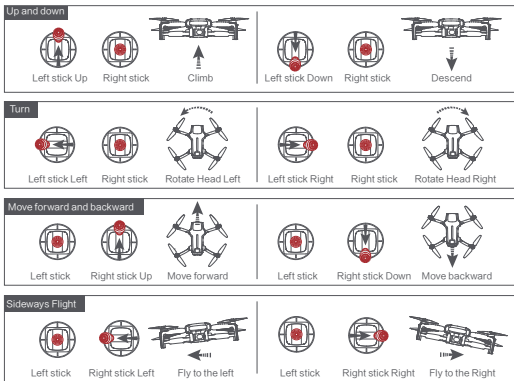

Note: The stick mode can be set in FIMI Navi app (the default is American hand).

Remote Controller Communication Range

- When operating an aircraft, it is necessary to timely adjust the orientation and distance between the remote controller and the aircraft, as well as adjust the antenna position to ensure that the aircraft always remains within the optimal communication range.
- When the antenna and the back of the remote controller form a 180° or 270° angle, and the antenna plane is facing the aircraft, it can ensure that the signal quality between the remote controller and the aircraft reaches the optimal state.

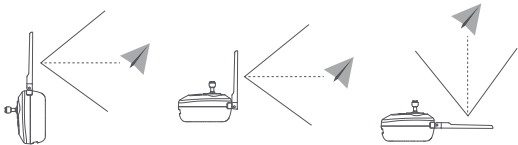

Note: Please do not use other communication devices on the same frequency band simultaneously to avoid interference with the remote controller signal.

Stop propellers in an emergency

- When motors can't properly turn off, please toggle the left stick to the bottom inner in maximum range, and press Auto return-to-home button for 5 seconds simultaneously, the motors will stop.

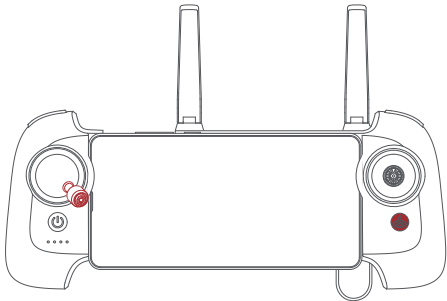

Safety tips: Do not do the operation above during normal flight to avoid motors being stopped in the air.

Flying Condition Requirement

1. The drone is suitable for people above 16 years who have full civil capacity.
2. Make sure to keep some distance from people, animals, trees, vehicles and buildings while using the drone. Please be careful when someone approaches.
3. Keep away from airports, railways, highways, high-rise buildings, utility poles and other dangerous environments when operating the drone.
4. Keep away from the areas with complex electromagnetic signals such as communication base stations and high-power antennas when operating the drone.
5. The flight altitude and distance of the drone relative to the takeoff point will be limited based on relevant regulations and policies.
6. Do not use this product at the place and time prohibited by regulations and policies.
7. To protect the legitimate rights and interests of users, please follow the product safety instructions when using.
8. Do not operate the drone in bad weather such as strong winds, rain, snow, or fog.
9. Please operate the drone in a broad place with a good GPS signal.
10. It is suggested that user should make the first flight under the guidance of an experienced pro.

Maintenance and Calibration

Remote Controller Calibration

Please try to calibrate the remote controller when you detect inconsistencies between stick control and drone flying. Select "RC Calibration" in the remote controller menu Tap "Start" to calibrate the center, do not move sticks Skip to sticks calibration once the center calibration succeed Skip to dial calibration once the sticks calibration succeed
Note: Please turn off the power of the drone before calibrating the remote controller.

RC calibration is not available in flight

Compass Calibration

If the magnetic field changes, the compass needs to be re-calibrated to ensure flight safety. If the drone's compass needs to be calibrated, the App will give corresponding hints and guidance. After entering the flight control menu, please select "compass calibration", and then calibrate based on prompts on the App.

Note: Please connect the drone before calibration. Compass calibration is not available in flight.

Gimbal Calibration

Click "gimbal calibration" and enter the calibration page in the gimbal settings menu. After the drone is placed smoothly, click to start calibration. Do not move the drone during the calibration process. After the calibration is completed, the App interface shows "Calibration succeed". If the App interface shows "Calibration failed", please recalibrate.

Note: Gimbal calibration is not available in flight.

Propellers Maintenance

Propellers are wearing parts. When they're damaged, replace them in time to ensure flight safety and efficiency.

Battery Maintenance

Do not throw the battery into fire; Do not batter the battery; Lithium battery's capacity reduces significantly in low temperature conditions. Do not use the battery when it is below 0 degrees. Do not place the battery under the burning sun.

Gimbal Maintenance

The gimbal of X8 MINI, integrated with the drone, does not need to disassemble. Please be careful not to scratch the camera when store the drone. Please keep the camera clean for better image quality.

Drone Self-check

The drone enters the self-check when the drone is powered on. If the self-check failed, App will pop up corresponding hints.

Firmware Upgrade

Please check the firmware version regularly, new version will be updated by Fimi Navi App to prompt users to update. Please download new firmware when the App is connected with the drone and remote controller

Drone Specifications

Drone

Model: FMWRJ04A3

Dimensions (folded, without propellers):

Length 145mm × Width 85mm × Height 56mm

Dimensions (unfolded, without propellers):

Length 200mm × Width 145mm × Height 56mm

Takeoff Weight: Approx. 245g

Diagonal Distance: 214mm

Max Ascent Speed: 5m/s

Max Descent Speed: 3.5m/s

Max Flight Speed: 18m/s *in a windless environment at sea level

Max Takeoff Altitude: \approx 4000m

Max Hovering Time: 29 minutes *Measured with the aircraft hovering in windless conditions, with visual and recording modes turned off, at sea level until the remaining battery level reaches 0%. This is for reference only; please pay attention to app prompts during actual flight.

Maximum Flight Time: 32 minutes *Measured with the aircraft flying forward at a speed of 21.6km/h in windless conditions at sea level until the remaining battery level reaches 0%. This is for reference only; please pay attention to app prompts during actual flight.

Max Tilt Angle: 35°

Max Wind Speed Resistance: 10.7m/s

Operating Temperature Range: 0-40°C

Satellite Navigation Systems: Beidou/GPS/GLONASS/Galileo

Hovering Accuracy, Vertical: \pm 0.1m (when Vision Positioning is active)
 \pm 0.5m (when GPS is active)

Horizontal: \pm 0.3m (when Vision Positioning is active)
 \pm 0.5m (when GPS is active)

Remote Controller

Model: FMYKQ04A3

Product Weight: Approx. 260g

Dimensions: 165mm x 89mm x 47mm

Operating Frequency:

2.4000 GHz -2.4835 GHz

5.725 GHz -5.850 GHz

Max Battery Life: 8 hours *Without charging the mobile device

4 hours *Charging the mobile device

*Measured with mobile device battery level above 95%; actual results may vary depending on different mobile devices and their battery levels at the time of testing. Please refer to actual usage.

Battery Type: Li-ion

Battery Capacity: 3500mAh

Nominal Voltage: 3.7V

Input: 5V  2A

Operating Temperature Range: 0~40°C

Charging Temperature Range: 5~40°C

Max Signal Effective Range

(No interference, No obstruction) FCC: Approximately 9 km *The above data is measured in an outdoor open environment interference and is the farthest communication distance for one-way non-return flights under various standards. Please pay attention to the app's return prompts during actual flights.

Minimum Latency: Approx. 120 milliseconds

Supported Mobile Device Interface Types: Lightning, USB-C

Gimbal

Three-axis Mechanical Gimbal: -110° ~ 40°(Pitch)
-40° ~ 40°(Roll)
-40° ~ 40°(Yaw)
Controllable Rotation Range: 10° ~ -90° (Pitch)
Angular Vibration Range: ±0.005°

Camera

Image Sensor: 1/2-inch CMOS
Lens: FOV 79°
Aperture: f1.6
Format Length: 4.71mm
Format Equivalent: 24mm
Focus: 1 to ∞
Effective Pixels: 4800 million pixels
ISO Range: Video Manual 100-6400
Video Automatic 100-25600
Photo 100-6400
Shutter Speed: 1/8000s-2s
Max Photo Size: 8064 × 6048
Max Video Resolution: 3840 × 2160@60/30/25/24fps
Max Bitrate: 100Mbps
Video Format: MP4
File System: FAT32/exFAT
Photo Format:JPG
Digital Zoom: 12x

Intelligent Flight Battery

Capacity: 2200mAh
Weight: Approx. 85g
Nominal Voltage: 7.7V
Charging Limited Voltage: 8.8V
Battery Type: Li-ion 2S
Energy: 16.92Wh
Charging Temperature: 5-40°C

Intelligent Flight Battery Plus

Capacity: 3100mAh
Weight: Approx. 106g
Nominal Voltage: 7.2V
Charging Limited Voltage: 8.4V
Battery Type: Li-ion 2S
Energy: 22.32Wh
Charging Temperature: 5-40°C

Official website: www.fimi.com

Customer service email: support@fimi.com

Service hotline: 400-661-0908

Manufacturer : Shenzhen FIMI Robot Technology Co.,Ltd

Address: No.1213-1217,12F,West Block,Tianliao Building, 1133 Xueyuan Avenue,
Taoyuan Street, Nanshan District, Shenzhen City,Guangdong Province, China