

Petrel 75Whoop FPV Racing Drone

Manual



Contents

Product Specifications.....	1
Interface Description.....	2
Check the flight control drive.....	3
Calibration accelerometer.....	4
UART serial port use.....	5
Select aircraft model.....	6
Choose ESC protocol.....	7
Voltage and current parameters setting.....	8
Setting up the receiver.....	9
VTX serial port use.....	10
Check receiver signal.....	11
Select flight mode startup mode.....	12
OSD settings.....	13
LED settings.....	14
Troubleshooting.....	15

.....

Package Included

HGLRC Petrel 75Whoop FPV Racing Drone*1	Accessory Package*1
---	---------------------

1. Product Specifications

Product parameters	
Model	Petrel 75Whoop VTX FPV Racing Drone
Frame Kit	Petrel 75Whoop Frame Kit
Flight Controller	Zeus5 AIO Flight Controller
VTX	Zeus nano 350mW
Motor	0802 Motor 1S KV22000/2S KV17000
Support Receiver	SBUS .DSMX.CRSF
Input Voltage	1/2S Lipo
Weight	33.4g

2. Interface Description

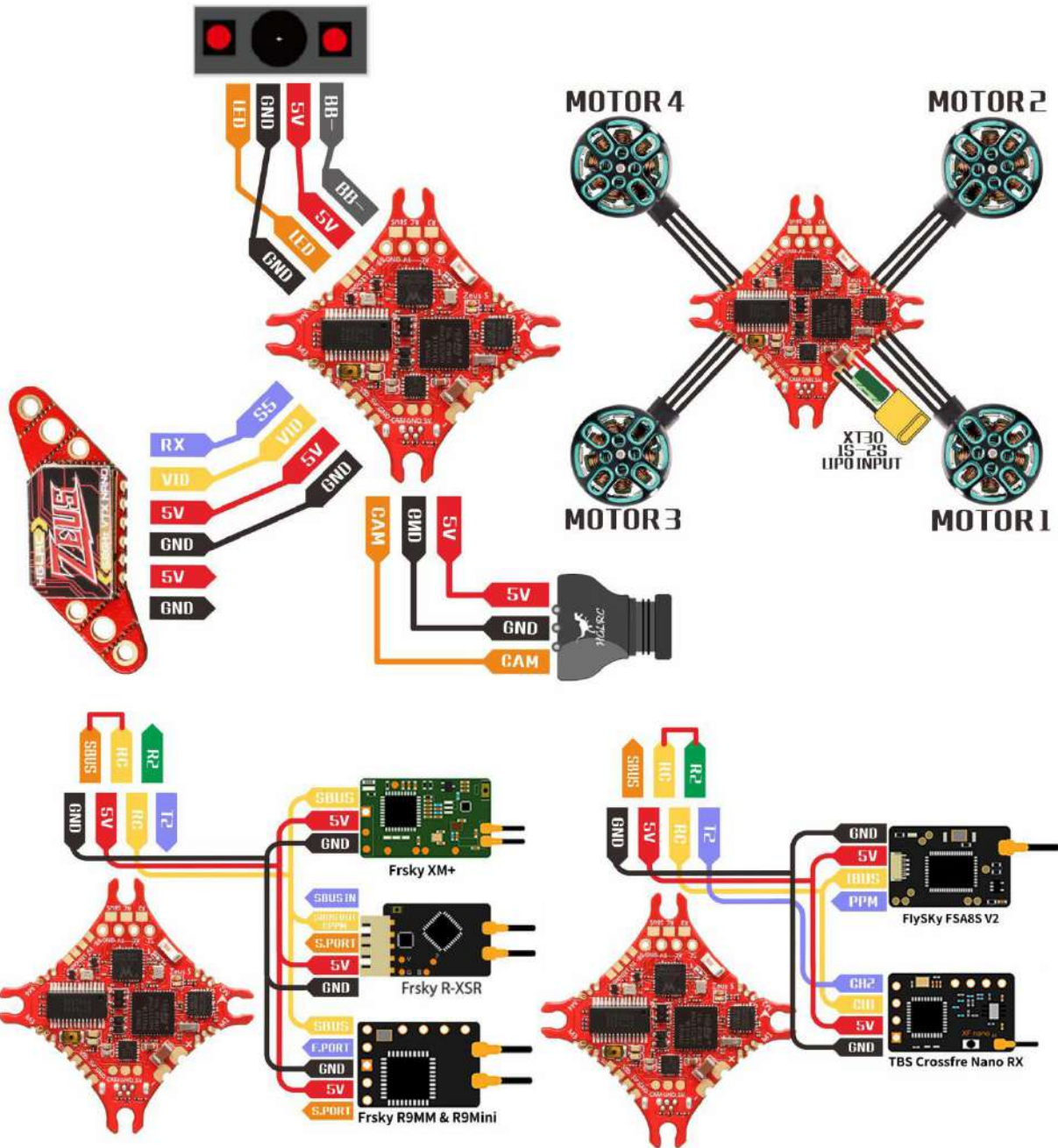

3. Check the flight control drive

1. Long Press BOOT buttons.connect USB.The system automatically install the driver



2.Driver cannot be installed, please download ImpulseRC_Driver_Fixer



3.Double-click on the run(Plug in the flight controller to automatically install the driver)

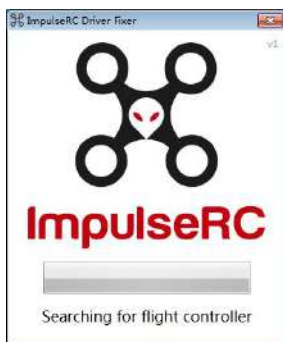

4.open betafight configurator  , enter DFU mode

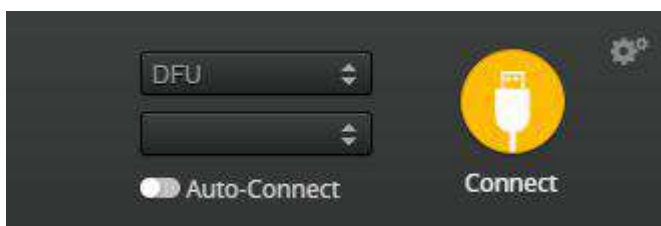

5. Click **Firmware Flasher** Select firmware version

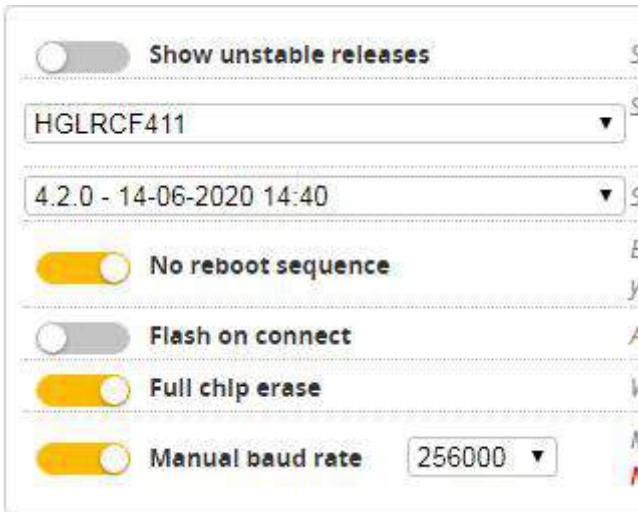

6. Click **Load Firmware [Online]** Load firmware. **Flash Firmware** Waiting for completion **Erasing ...** It will be prompted upon completion. **Programming: SUCCESSFUL**

7. open betaflyght configurator . Controller plugged into the computer. Betaflight Automatically assigned port, click "Connect" Enter setup interface (Different computer COM)

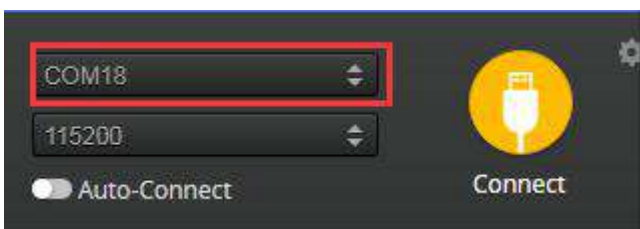

4. Calibration accelerometer

1. Put the aircraft horizontal and click “Reset Z axis”

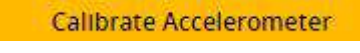
Click again 

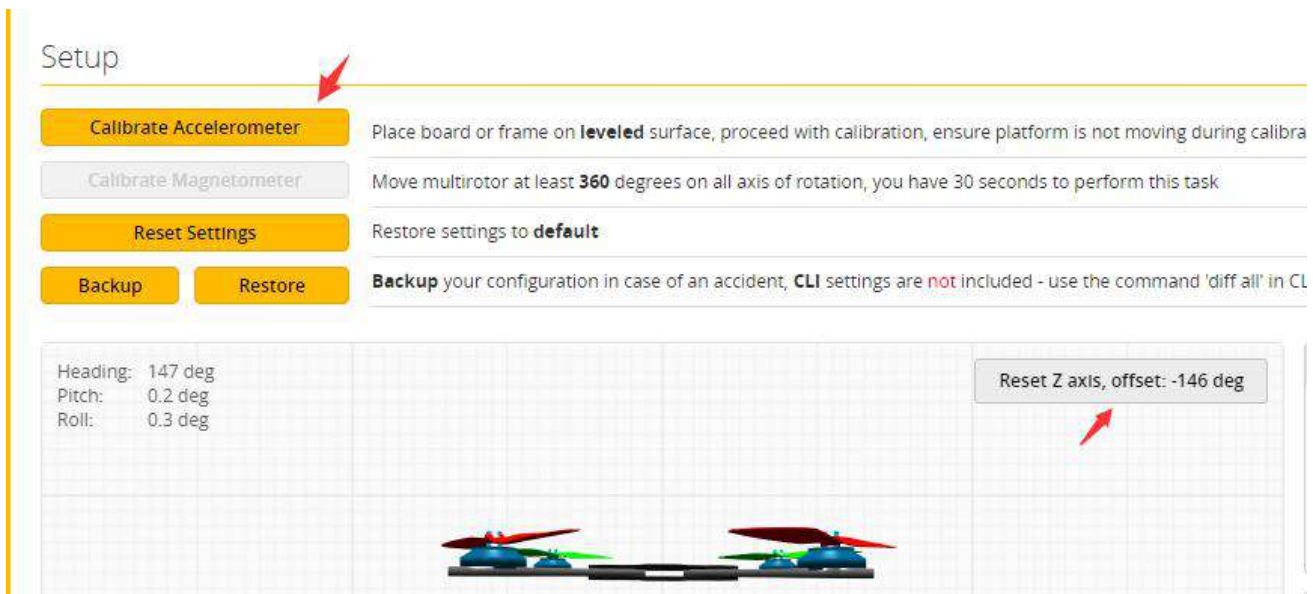

5. UART serial port use

1. UART1 uses WIFI

Open WIFI CLI command:

```
“resource PINIO 1 B10
serial 0 1 115200 57600 0 115200
set pinio_config = 129,1,1,1
set pinio_box = 0,255,255,255

SAVE”
```

2. UART2 uses receiver

S5 is a soft serial port, dedicated to video transmission (VTX) FM

CLI command of soft serial port:

```
"resource MOTOR 5 none  
resource SERIAL_TX 11 B03  
SAVE"
```

6. Select aircraft model

1. Click  Configuration Select model

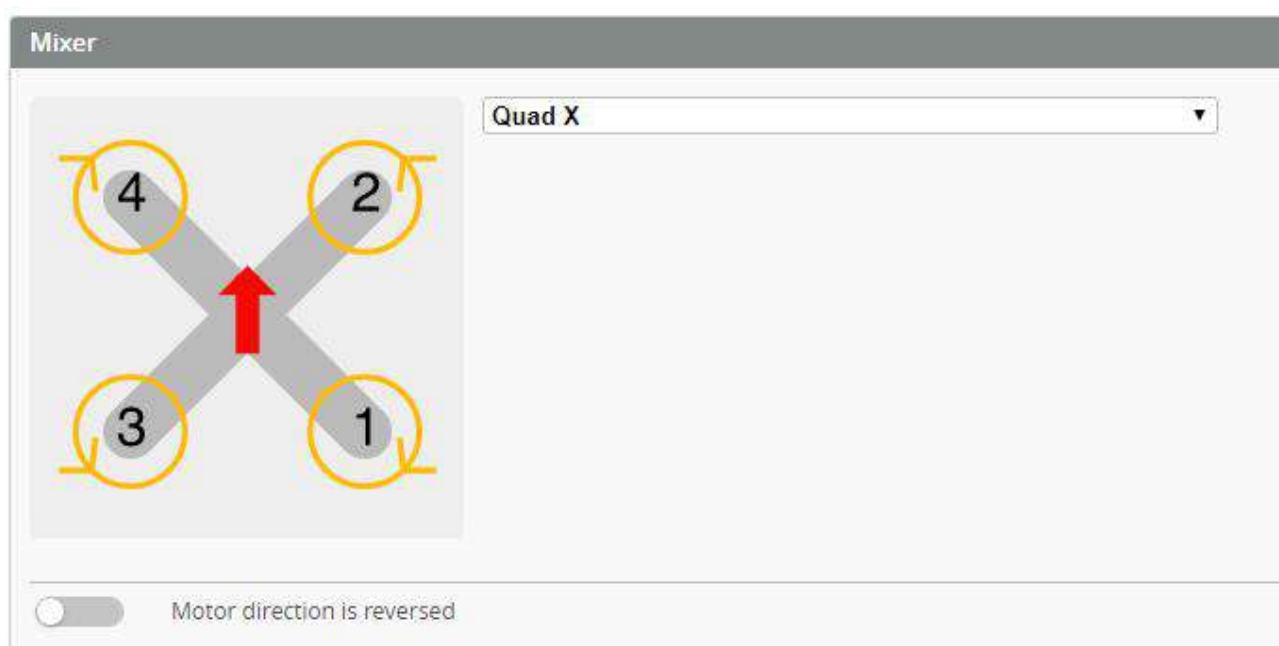

2. Click  Click “**I understand the risks**” Push Master to check motor steering “**Master**” Steering can be changed at [BLHeliSuite](#)

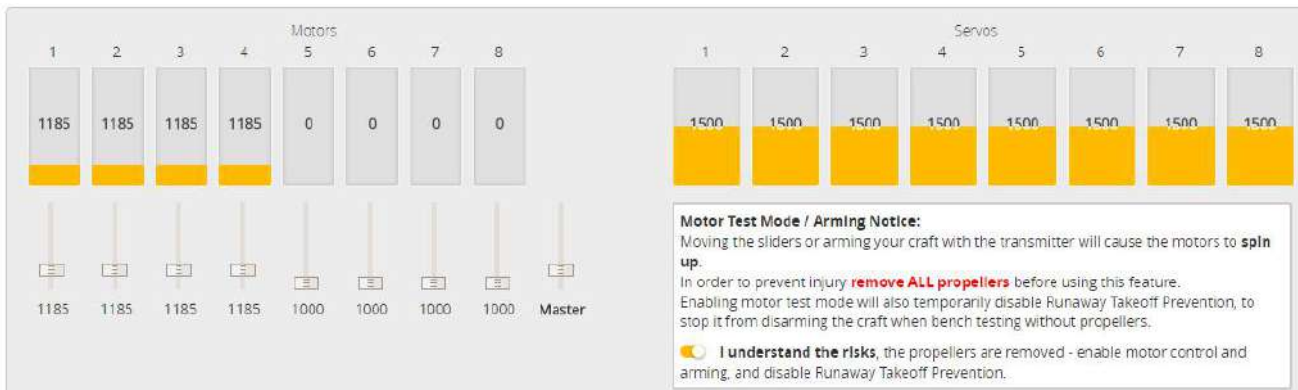

7. Choose ESC protocol

1. Choose the right ESC protocol, the optional universal protocol DSHOT600.

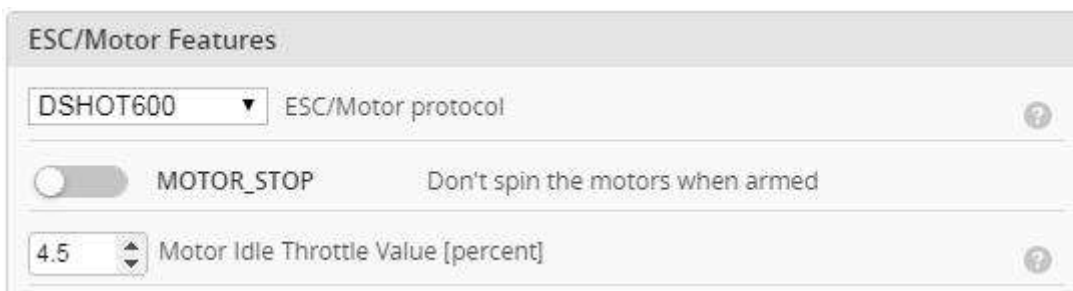

8. Voltage and current parameters setting

1. Click **Power & Battery** Setting parameters

Power & Battery

Battery	
Onboard ADC	Voltage Meter Source
Onboard ADC	Current Meter Source
3.3	Minimum Cell Voltage
4.3	Maximum Cell Voltage
3.5	Warning Cell Voltage
0	Capacity (mAh)

Voltage Meter	
Battery	0 V
	111 Scale
	10 Divider Value
	1 Multiplier Value

Amperage Meter	
Battery	0.00 A
	179 Scale [1/10th mV/A]
	0 Offset [mA]

9. Setting up the receiver

1. Receiver connection diagram

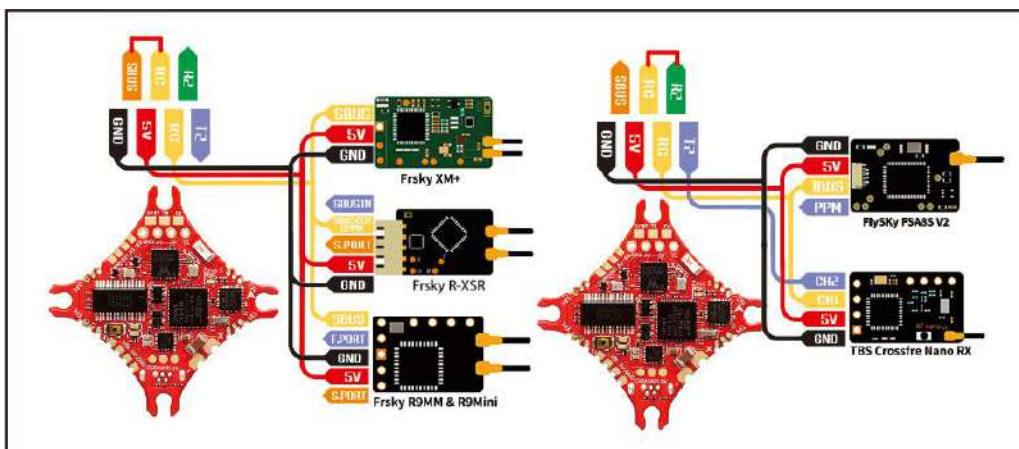

2. Click  Ports. We have found “UART2” Open the receiver serial port

Identifier	Configuration/MSP	Serial Rx	Telemetry Output	Sensor Input	Peripherals
USB VCP	<input checked="" type="checkbox"/> 115200 ▼	<input type="checkbox"/>	Disabled ▼ AUTO ▼	Disabled ▼ AUTO ▼	Disabled ▼ AUTO ▼
UART1	<input checked="" type="checkbox"/> 115200 ▼	<input type="checkbox"/>	Disabled ▼ AUTO ▼	Disabled ▼ AUTO ▼	Disabled ▼ AUTO ▼
UART2	<input type="checkbox"/> 115200 ▼	<input checked="" type="checkbox"/>	Disabled ▼ AUTO ▼	Disabled ▼ AUTO ▼	Disabled ▼ AUTO ▼
SOFTSERIAL1	<input type="checkbox"/> 115200 ▼	<input type="checkbox"/>	Disabled ▼ AUTO ▼	Disabled ▼ AUTO ▼	VTX (IRC Tran ▼ AUTO ▼

3. Set the SBUS receiver

Receiver

Serial-based receiver (SPEKSAT, S ▼) Receiver Mode

Note: Remember to configure a Serial Port (via Ports tab) and choose a Serial Receiver Provider when using RX_SERIAL feature.

SBUS ▼ Serial Receiver Provider

4. Set the DSMX receiver

Receiver

Serial-based receiver (SPEKSAT, S ▼) Receiver Mode

Note: Remember to configure a Serial Port (via Ports tab) and choose a Serial Receiver Provider when using RX_SERIAL feature.

SPEKTRUM2048 ▼ Serial Receiver Provider

5. Set the CRSF receiver

Receiver

Serial-based receiver (SPEKSAT, S ▼) Receiver Mode

Note: Remember to configure a Serial Port (via Ports tab) and choose a Serial Receiver Provider when using RX_SERIAL feature.

CRSF ▼ Serial Receiver Provider

10.VTX serial port use wiring

1. 5.8G VTX connection

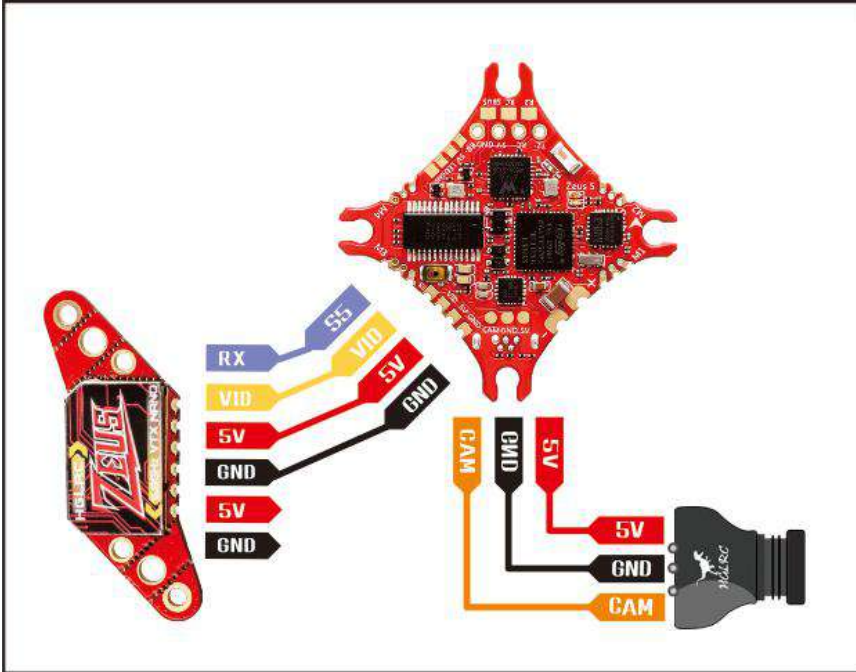

2. 5.8G VTX serial port opens. The protocol is selected according to its own VTX protocol.

Identifier	Configuration/MSP	Serial Rx	Telemetry Output	Sensor Input	Peripherals
USB VCP	<input checked="" type="checkbox"/> 115200 ▼	<input type="checkbox"/>	Disabled ▼ AUTO ▼	Disabled ▼ AUTO ▼	Disabled ▼ AUTO ▼
UART1	<input checked="" type="checkbox"/> 115200 ▼	<input type="checkbox"/>	Disabled ▼ AUTO ▼	Disabled ▼ AUTO ▼	Disabled ▼ AUTO ▼
UART2	<input type="checkbox"/> 115200 ▼	<input checked="" type="checkbox"/>	Disabled ▼ AUTO ▼	Disabled ▼ AUTO ▼	Disabled ▼ AUTO ▼
SOFTSERIAL1	<input type="checkbox"/> 115200 ▼	<input type="checkbox"/>	Disabled ▼ AUTO ▼	Disabled ▼ AUTO ▼	VTX (IRC Tran ▼ AUTO ▼)

3. Use OSD to adjust VTX

which displays information like battery voltage and mAh consumed while you fly. In addition, the Betaflight OSD can be used to configure the quadcopter, making in-field adjustments and tuning more convenient.

MODE2

MODE1

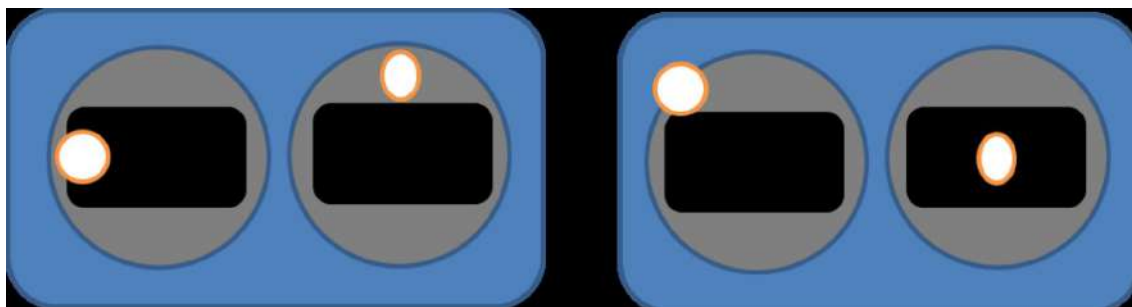

The graphics above show the stick command to bring up the OSD menu. The stick command is: throttle centered, yaw left, pitch forward. The exact stick command therefore depends on which mode your transmitter sticks are in.

In the OSD menu, use pitch up/down to move the cursor between menu items. When a menu option has a > symbol to the right of it, this indicates that it contains a sub-menu. Roll-right will enter the sub-menu. For example, in the screen to the right, moving the cursor to “Features” and then moving the roll stick to the right will enter the “Features” sub-menu.

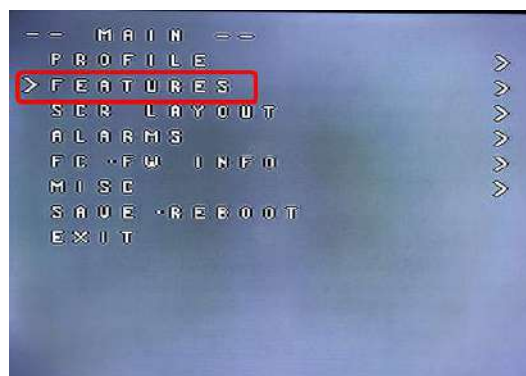

If you are using a video transmitter that supports remote configuration, enter the “Features” menu to configure the vTX. From there, enter either “VTX SA” if you are using SmartAudio (TBS Unify) or “VTX TR” if you are using IRC Tramp Telemetry.

To adjust PIDs, rates, and other tuning-related parameters, enter the “Profile” sub-menu.

In the “Scr Layout” sub-menu, you can move the OSD elements (like battery voltage, mAh, and so forth) around on the screen.

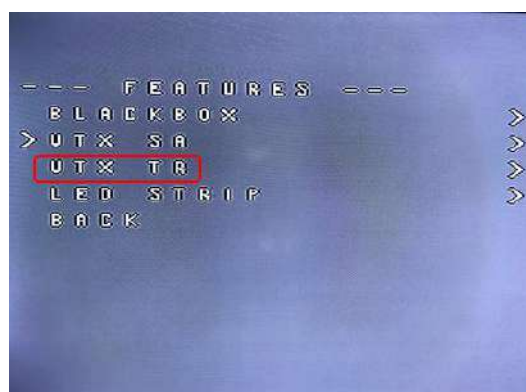

The “Alarms” sub-menu lets you control when the OSD will try to alert you that battery voltage is too low or mAh consumed is too high.

When a parameter can be modified, the parameter's current value will be shown on the right-hand side of the screen. In this case, roll left/right will adjust the parameter up and down.

The screen to the right shows the current vTX settings. From here, you can change the frequency band, channel, and power level of the video transmitter. After making the changes, move the cursor to "Set" and press roll-right to confirm the settings.

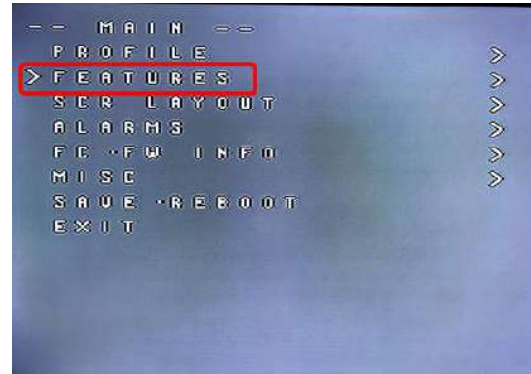

11. Check receiver signal

1. Click  Receiver Check the remote control output signal

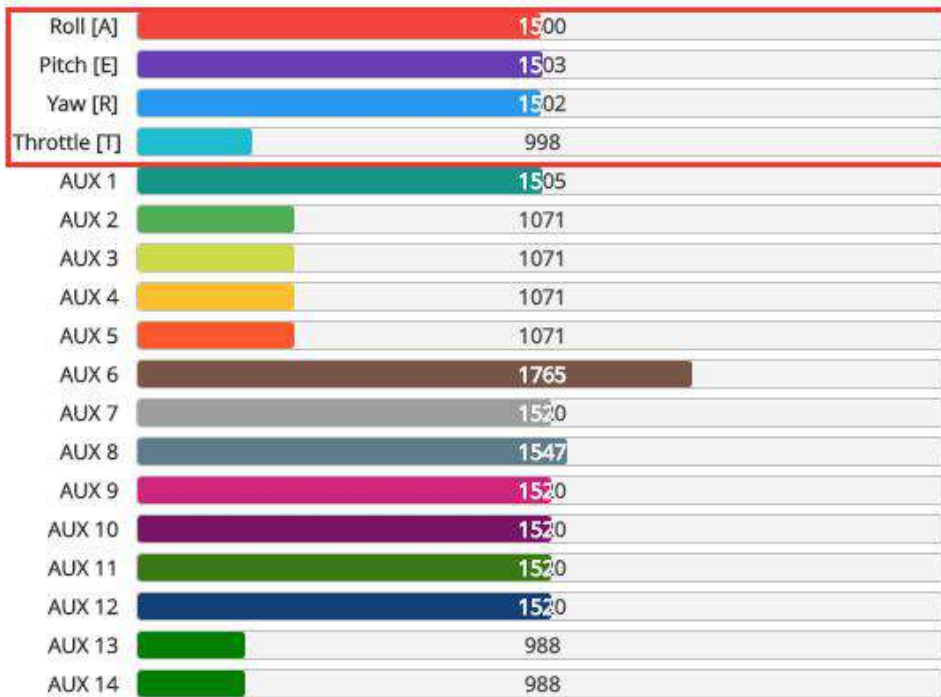

12. Select flight mode startup mode

1. Click  Modes set up the function of remote control switch across the channel (below are for reference only)

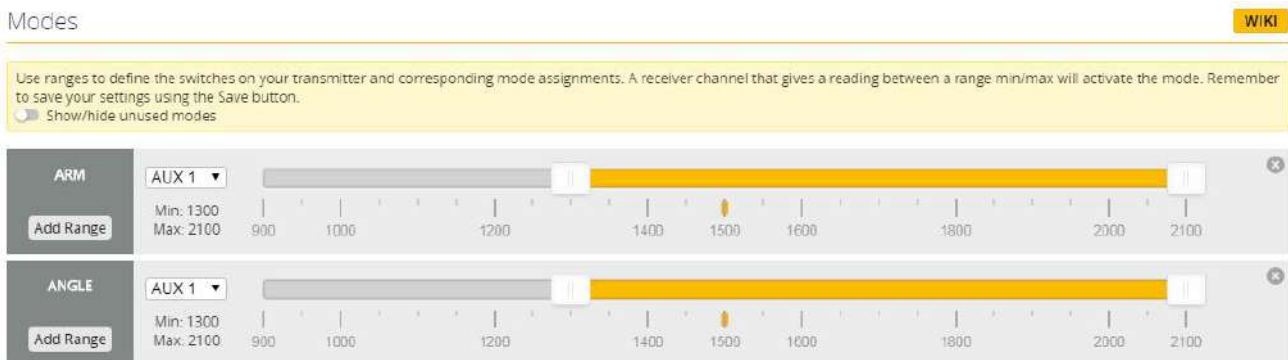

13. OSD settings

1. Click  OSD the OSD Settings, according to the need to choose, drag the OSD schematic diagram of the parameters can be adjusted.

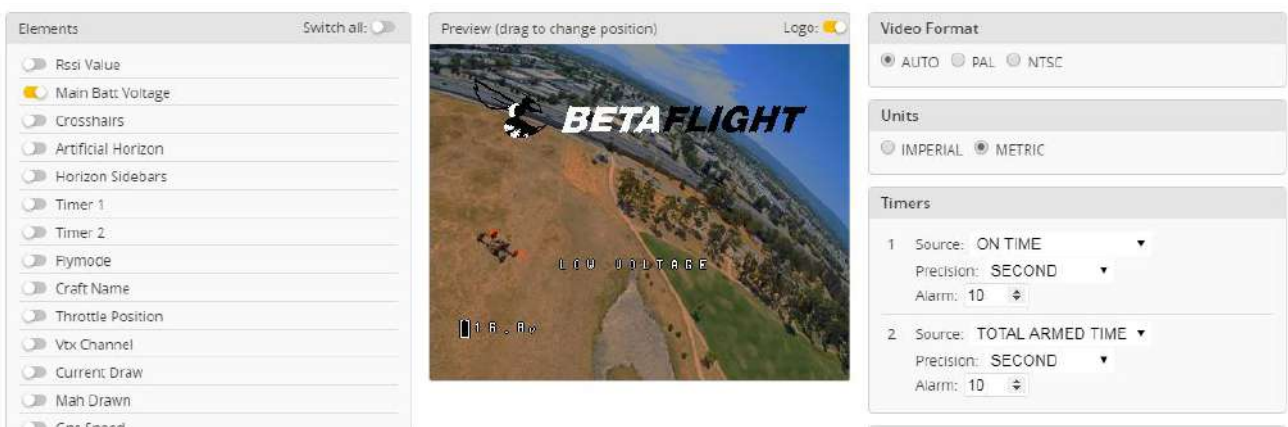

14.LED settings

1.Click  Configuration Turn on LED support



2.Click  LED Strip .Click  Wire Ordering Mode set according to need

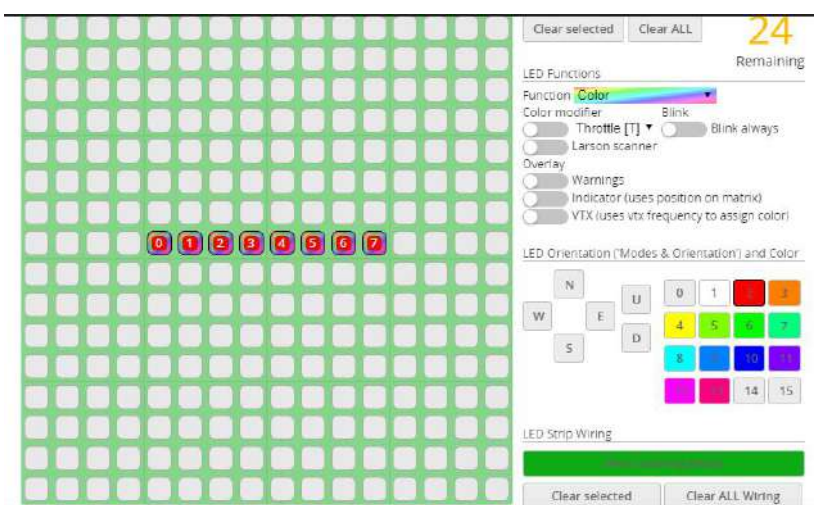

15.Troubleshooting

Warning:

Please read the cautions as follows, otherwise stability of your flight controller cannot be ensured, your flight controller will even get damaged.

- Keep focus on the polarity. Check carefully before power supply.
- Cut off the power when you connect, plug and pull anything.
- The refresh rate of PID and Gyroscope is up to 8K/8K.

after sales question:

1. After receiving the goods, it is found that the product can not be used normally. If the return to the factory is a quality problem, the repair service will be provided free of charge.
2. If the product is damaged due to improper operation, the repair service may be provided under the condition that the inspection can be repaired.
3. For domestic customers, please contact the after-sales service personnel. For overseas customers, please contact the official website for after-sales service.

Product daily problems

1.OSD garbled:

If you find garbled characters, please open Betaflight, click "OSD" .and click "Font Manager" clicks on "Upload Font" to update

1. When plugged in the battery, the aircraft does not pass the self-test

without "BBB" sound. There is only one sound.

Please check if the ESC agreement is correct

3.The spin of the aircraft keeps spinning

1. Please check if the propeller is correct
2. Please check if the motor direction is correct