



HGLRC Wind6 FPV Racing Drone 6S

Manual





Contents

Product Specifications.....	1
Interface Description.....	2
Check the flight control drive.....	3
Calibration accelerometer.....	4
URAT serial port use.....	5
Select aircraft model.....	6
Choose ESC/Motor protocol.....	7
Voltage and current parameters setting.....	8
Setting up the receiver.....	9
VTX uses OSD smart audio.....	10
GPS parameters setting.....	11
Check receiver signal.....	12
Select flight mode startup mode.....	13
OSD settings.....	14
LED settings.....	15
switching gyro.....	16
Troubleshooting.....	17

.....

Package Included

HGLRC Wind6 FPV Racing Drone 6S*1	Accessory Package*1
-----------------------------------	---------------------



1. Product Specifications

Product parameters	
Model	HGLRC Wind6 FPV Racing Drone 6S
Frame Kit	Wind6 Frame Kit
Flight Controller	FD F765 Stack
VTX	FD VTX
Camera	Aurora V2 Camera
Motor	FD2408 1700KV
Support Receiver	SBUS .PPM .DSMX
Input Voltage	5-6S Lipo
Product package size	283*260*77mm
Weight	389g

2. Interface Description

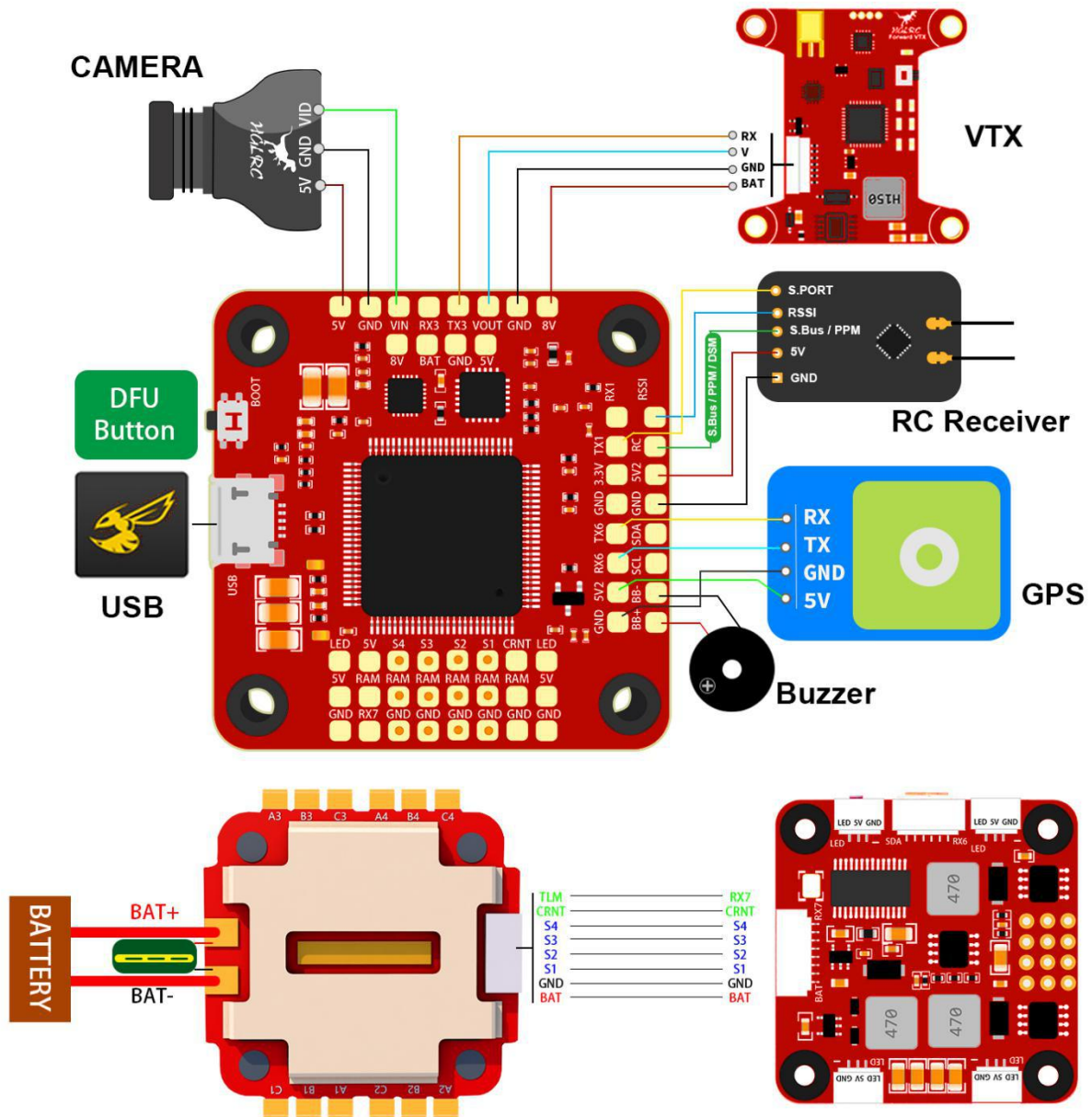

3. Check the flight control drive

1. Long Press BOOT buttons.connect USB.The system automatically install the driver



2.Driver cannot be installed, please download ImpulseRC_Driver_Fixer



3.Double-click on the run(Plug in the flight controller to automatically install the driver)

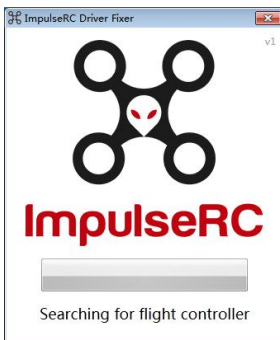

4.open betaflyght configurator , enter DFU mode (It is recommended to use the latest Betaflight version)

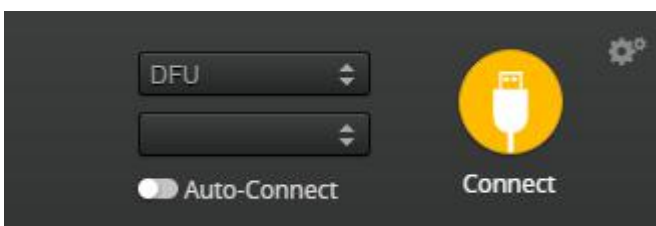

5. Click **Firmware Flasher** Select firmware version (Dual 8K is recommended. (Betaflight 4.0 firmware does not support 32K))

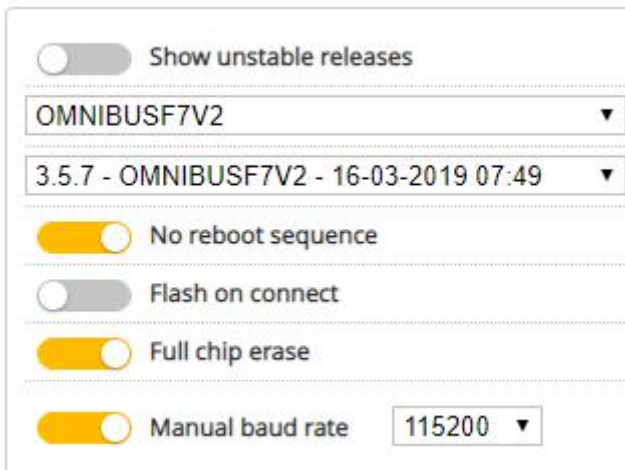

6. Click **Load Firmware [Online]** Load firmware. **Flash Firmware** Waiting for completion **Erasing ...** It will be prompted upon completion. **Programming: SUCCESSFUL**

7. open betaflyght configurator  . Controller plugged into the computer. Betaflight Automatically assigned port, click “Connect” Enter setup interface (Different computer COM)

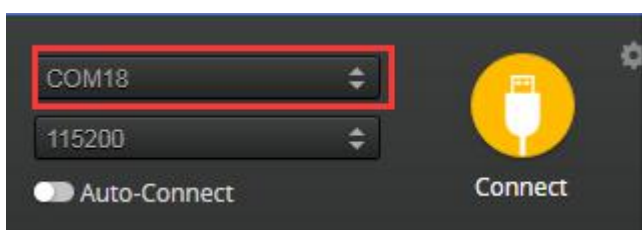

4. Calibration accelerometer

1. Put the aircraft horizontal and click “Reset Z axis”

Click again 

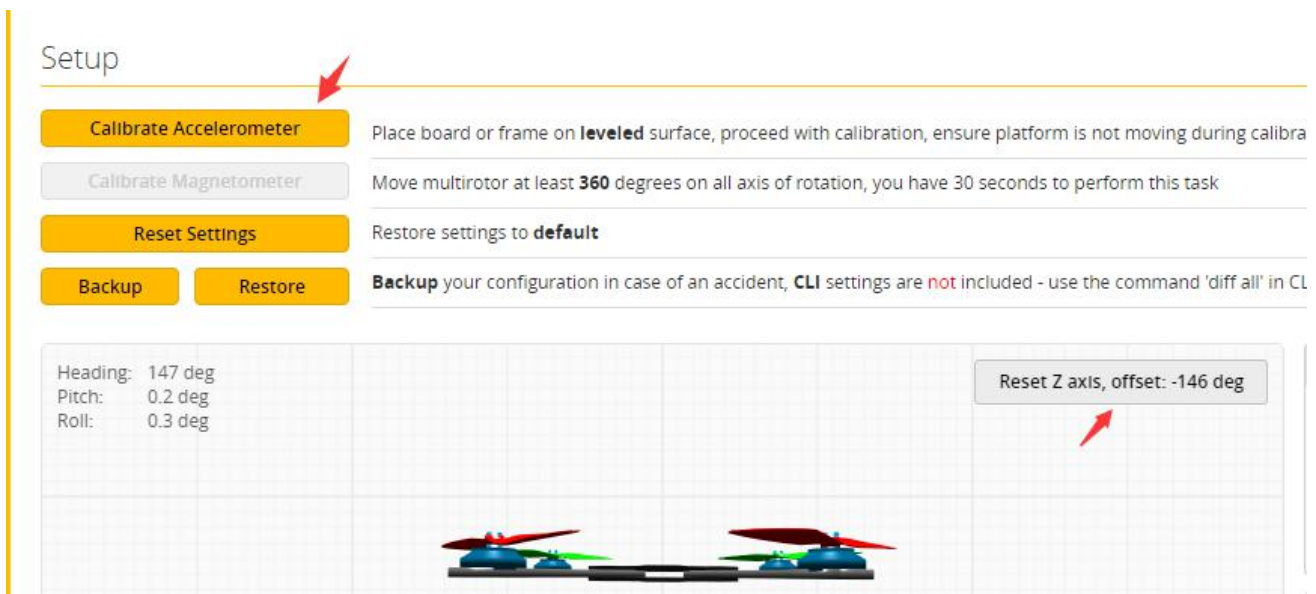

The screenshot shows a 'Setup' menu with several options:

- Calibrate Accelerometer** (highlighted with a red arrow): Place board or frame on **leveled** surface, proceed with calibration, ensure platform is not moving during calibration.
- Calibrate Magnetometer**: Move multirotor at least **360** degrees on all axis of rotation, you have 30 seconds to perform this task.
- Reset Settings**: Restore settings to **default**.
- Backup** and **Restore**: **Backup** your configuration in case of an accident, **CLI** settings are **not** included - use the command 'diff all' in CLI.

Below the menu, a 3D model of a multirotor aircraft is shown on a grid. A red arrow points to a button labeled "Reset Z axis, offset: -146 deg".

Heading: 147 deg
Pitch: 0.2 deg
Roll: 0.3 deg

5.URAT serial port use

URAT1 uses receiver telemetry

URAT2 uses the receiver

URAT3 uses VTX image transmission

URAT6 uses GPS

URAT7 uses ESC telemetry

6.Select aircraft model

1.Click  Configuration Select model

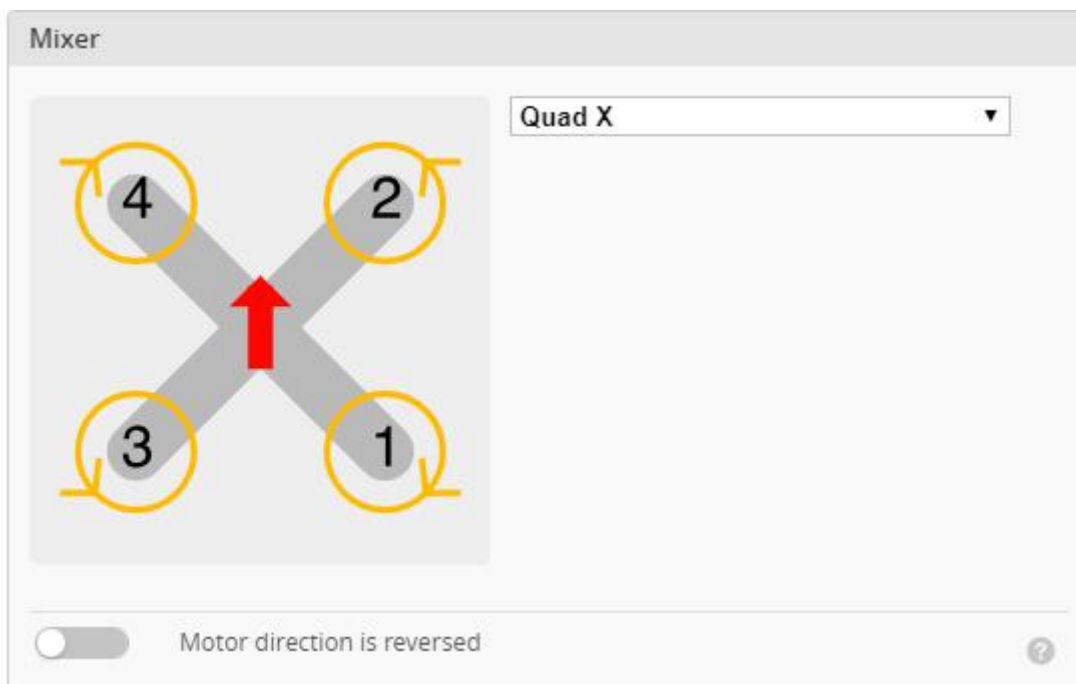

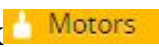
2. Click  **Motors** Click “**I understand the risks**” Push Master to check motor steering “**Master**” Steering can be changed at [BLHeliSuite](#)

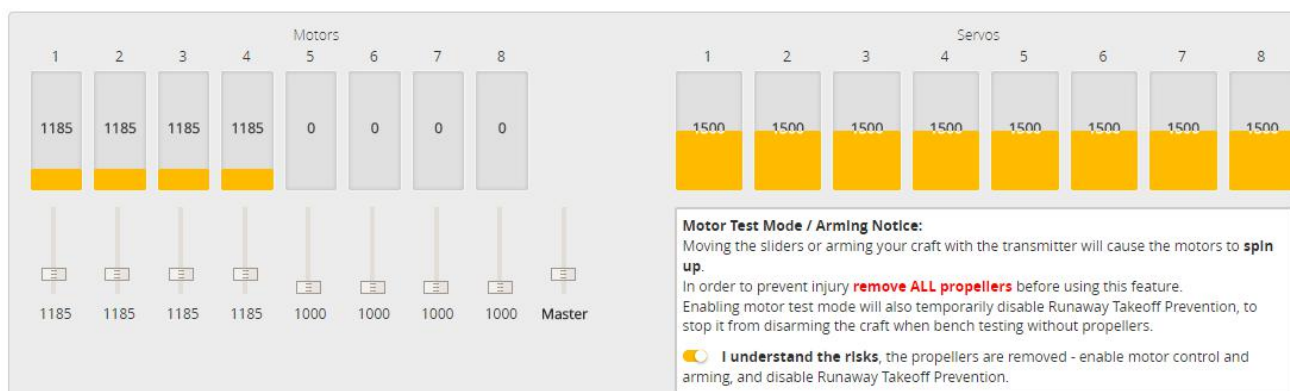

7. Choose ESC/Motor protocol

1. Choose the correct ESC / Motor protocol, Protocol DSHOT1200 is recommended for Wind5 Hybrid racing drone

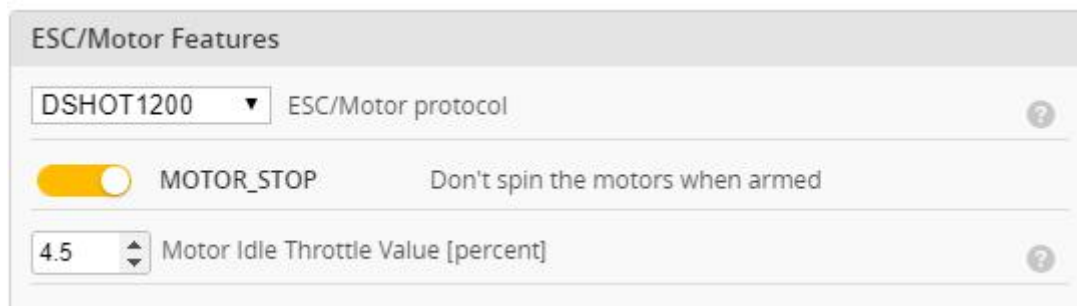

8. Voltage and current parameters setting

1. Click  Power & Battery Setting parameters

Battery	
Onboard ADC	Voltage Meter Source
Onboard ADC	Current Meter Source
3.3	Minimum Cell Voltage
4.3	Maximum Cell Voltage
3.5	Warning Cell Voltage
0	Capacity (mAh)

Voltage Meter			
Battery	0 V	110	Scale
		10	Divider Value
		1	Multiplier Value

Amperage Meter			
Battery	0.00 A	179	Scale [1/10th mV/A]
		0	Offset [mA]

9. Setting up the receiver

1. Receiver connection diagram

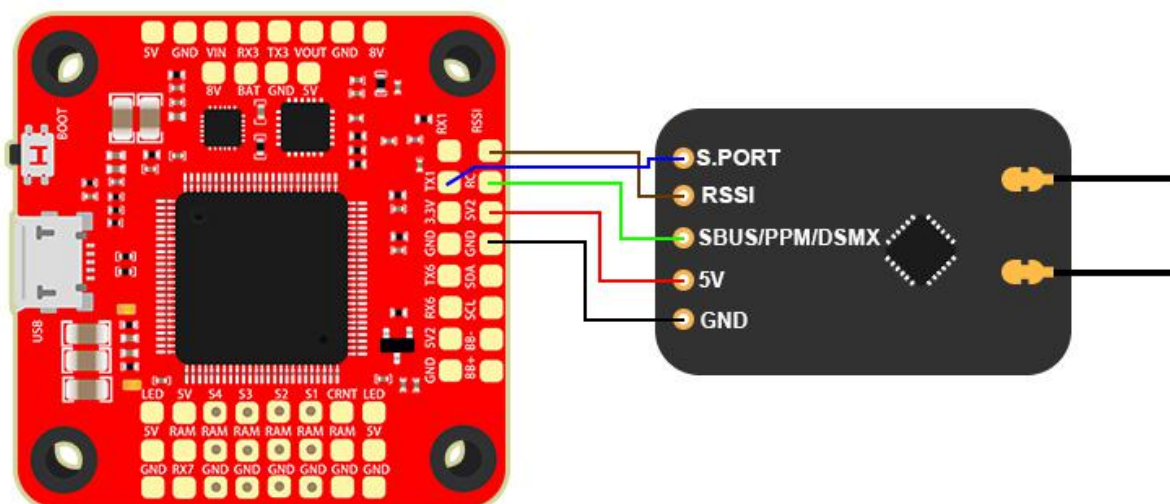

2. Click Ports have found “UART2” Open the receiver serial port

Identifier	Configuration/MSP	Serial Rx	Telemetry Output	Sensor Input	Peripherals
USB VCP	<input checked="" type="checkbox"/> 115200 ▼	<input type="checkbox"/>	Disabled ▼ AUTO ▼	Disabled ▼ AUTO ▼	Disabled ▼ AUTO ▼
UART1	<input type="checkbox"/> 115200 ▼	<input type="checkbox"/>	SmartPort ▼ AUTO ▼	Disabled ▼ AUTO ▼	Disabled ▼ AUTO ▼
UART2	<input type="checkbox"/> 115200 ▼	<input checked="" type="checkbox"/>	Disabled ▼ AUTO ▼	Disabled ▼ AUTO ▼	Disabled ▼ AUTO ▼
UART3	<input type="checkbox"/> 115200 ▼	<input type="checkbox"/>	Disabled ▼ AUTO ▼	Disabled ▼ AUTO ▼	IRC Tramp ▼ AUTO ▼
UART6	<input type="checkbox"/> 115200 ▼	<input type="checkbox"/>	Disabled ▼ AUTO ▼	GPS ▼ 9600 ▼	Disabled ▼ AUTO ▼
UART7	<input type="checkbox"/> 115200 ▼	<input type="checkbox"/>	Disabled ▼ AUTO ▼	ESC ▼ AUTO ▼	Disabled ▼ AUTO ▼

3. Set the SBUS receiver

Receiver

Serial-based receiver (SPEKSAT, S) Receiver Mode

Note: Remember to configure a Serial Port (via Ports tab) and choose a Serial Receiver Provider when using RX_SERIAL feature.

SBUS Serial Receiver Provider

4. Set the PPM receiver

Receiver

PPM RX input Receiver Mode

5. Set the DSMX receiver

Receiver

Serial-based receiver (SPEKSAT, S) Receiver Mode

Note: Remember to configure a Serial Port (via Ports tab) and choose a Serial Receiver Provider when using RX_SERIAL feature.

SPEKTRUM2048 Serial Receiver Provider

5. Turn on the receiver telemetry serial port Function on

SOFTSERIAL Enable CPU based serial ports

Identifier	Configuration/MSP	Serial Rx	Telemetry Output	Sensor Input	Peripherals
USB VCP	<input checked="" type="checkbox"/> 115200	<input type="checkbox"/>	Disabled AUTO	Disabled AUTO	Disabled AUTO
UART1	<input type="checkbox"/> 115200	<input type="checkbox"/>	Disabled AUTO	Disabled AUTO	Disabled AUTO
UART2	<input type="checkbox"/> 115200	<input checked="" type="checkbox"/>	Disabled AUTO	Disabled AUTO	Disabled AUTO
UART3	<input type="checkbox"/> 115200	<input type="checkbox"/>	Disabled AUTO	Disabled AUTO	VTX (IRC Tran AUTO
UART6	<input type="checkbox"/> 115200	<input type="checkbox"/>	Disabled AUTO	Disabled AUTO	Disabled AUTO
UART7	<input type="checkbox"/> 115200	<input type="checkbox"/>	Disabled AUTO	ESC AUTO	Disabled AUTO
SOFTSERIAL1	<input type="checkbox"/> 115200	<input type="checkbox"/>	SmartPort AUTO	Disabled AUTO	Disabled AUTO

TELEMETRY Telemetry output

10.VTX uses OSD smart audio

1.VTX connection diagram

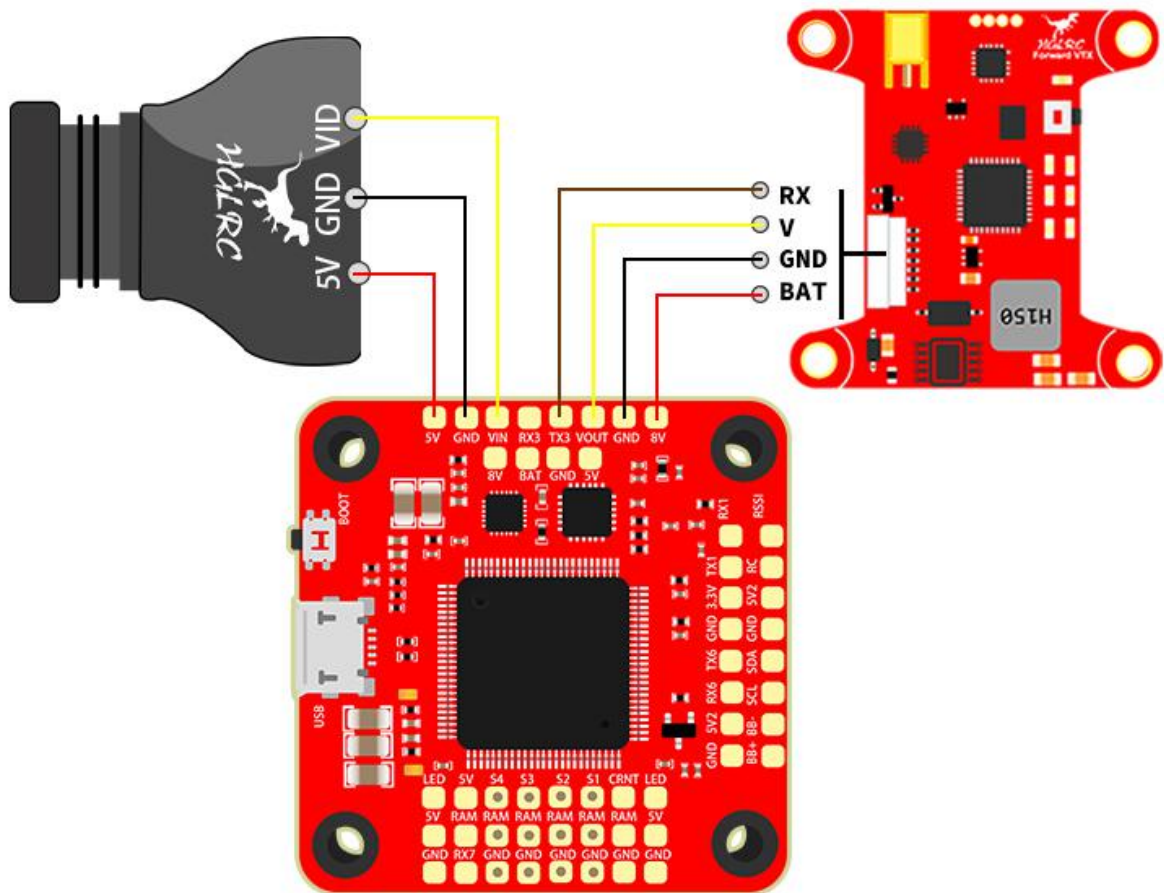

2.VTX serial port opens. The protocol is selected according to its own VTX protocol.

Identifier	Configuration/MSP	Serial Rx	Telemetry Output	Sensor Input	Peripherals
USB VCP	<input checked="" type="checkbox"/> 115200 ▾	<input type="checkbox"/>	Disabled ▾ AUTO ▾	Disabled ▾ AUTO ▾	Disabled ▾ AUTO ▾
UART1	<input type="checkbox"/> 115200 ▾	<input type="checkbox"/>	Disabled ▾ AUTO ▾	Disabled ▾ AUTO ▾	Disabled ▾ AUTO ▾
UART2	<input type="checkbox"/> 115200 ▾	<input checked="" type="checkbox"/>	Disabled ▾ AUTO ▾	Disabled ▾ AUTO ▾	Disabled ▾ AUTO ▾
UART3	<input type="checkbox"/> 115200 ▾	<input type="checkbox"/>	Disabled ▾ AUTO ▾	Disabled ▾ AUTO ▾	Disabled ▾ AUTO ▾
UART6	<input type="checkbox"/> 115200 ▾	<input type="checkbox"/>	Disabled ▾ AUTO ▾	Disabled ▾ AUTO ▾	Disabled ▾ AUTO ▾
UART7	<input type="checkbox"/> 115200 ▾	<input type="checkbox"/>	Disabled ▾ AUTO ▾	ESC ▾ AUTO ▾	VTX (IRC Tran ▾ AUTO ▾ Disabled Blackbox logging VTX (TBS SmartAudio) VTX (IRC Tramp) Camera (RunCam Protocol) Benewake LIDAR
SOFTSERIAL1	<input type="checkbox"/> 115200 ▾	<input type="checkbox"/>	SmartPort ▾ AUTO ▾	Disabled ▾ AUTO ▾	Disabled ▾ AUTO ▾

3. Fourth, frequency and power control methods:

1. Button frequency control: Short press once to change channel number CH (CH1-CH8) long press for 2 seconds and then short press to change frequency group FR (A-B-E-F-R-L)

2. Button power control: Long press button for 6 seconds and then short press button to change power level PIT/25mw/50mw/100mw/200mw/ 400mw:

4. Use OSD to adjust VTX

which displays information like battery voltage and mAh consumed while you fly. In addition, the Betaflight OSD can be used to configure the quadcopter, making in-field adjustments and tuning more convenient.

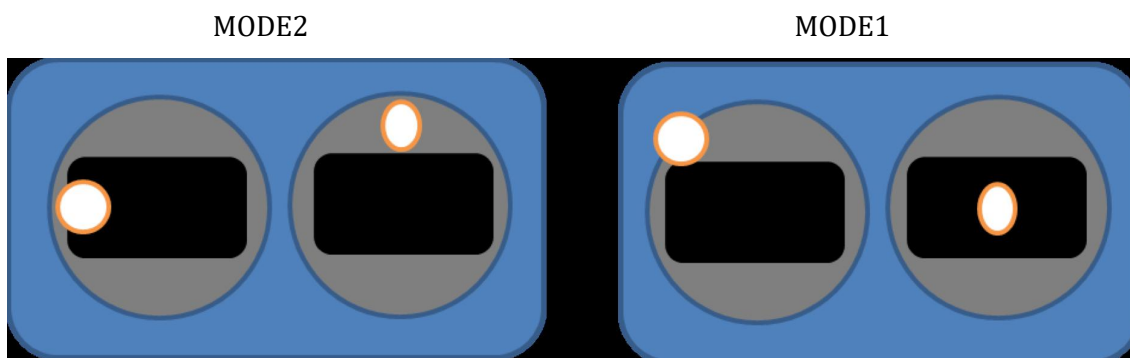

The graphics above show the stick command to bring up the OSD menu. The stick command is: throttle centered, yaw left, pitch forward. The exact stick command therefore depends on which mode your transmitter sticks are in.

In the OSD menu, use pitch up/down to move the cursor between menu items. When a menu option has a > symbol to the right of it, this indicates that it contains a sub-menu. Roll-right will enter the sub-menu. For example, in the screen to the right, moving the cursor to “Features” and then moving the roll stick to the right will enter the “Features” sub-menu.

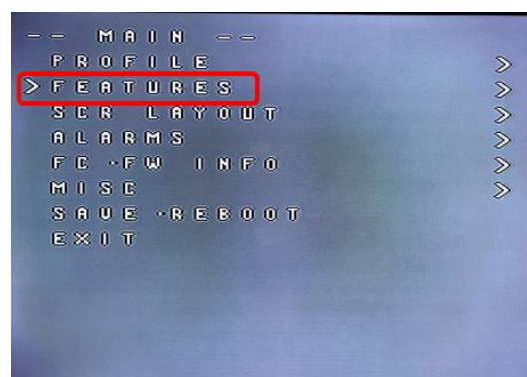



If you are using a video transmitter that supports remote configuration, enter the “Features” menu to configure the vTX. From there, enter either “VTX SA” if you are using SmartAudio (TBS Unify) or “VTX TR” if you are using IRC Tramp Telemetry.

To adjust PIDs, rates, and other tuning-related parameters, enter the “Profile” sub-menu.

In the “Scr Layout” sub-menu, you can move the OSD elements (like battery voltage, mAh, and so forth) around on the screen.

The “Alarms” sub-menu lets you control when the OSD will try to alert you that battery voltage is too low or mAh consumed is too high.

When a parameter can be modified, the parameter’s current value will be shown on the right-hand side of the screen. In this case, roll left/right will adjust the parameter up and down.

The screen to the right shows the current vTX settings. From here, you can change the frequency band, channel, and power level of the video transmitter. After making the changes, move the cursor to “Set” and press roll-right to confirm the settings.

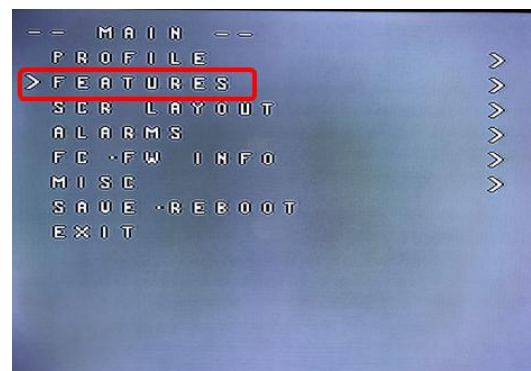
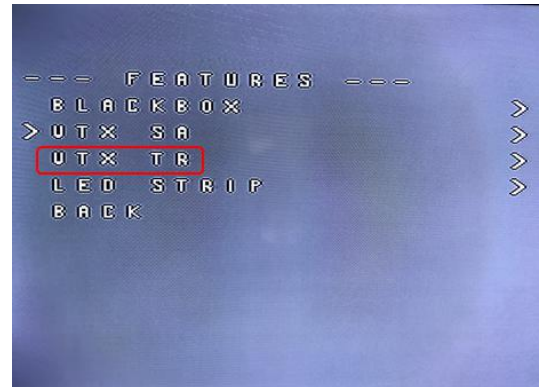

11.GPS parameters setting

1. GPS connection diagram

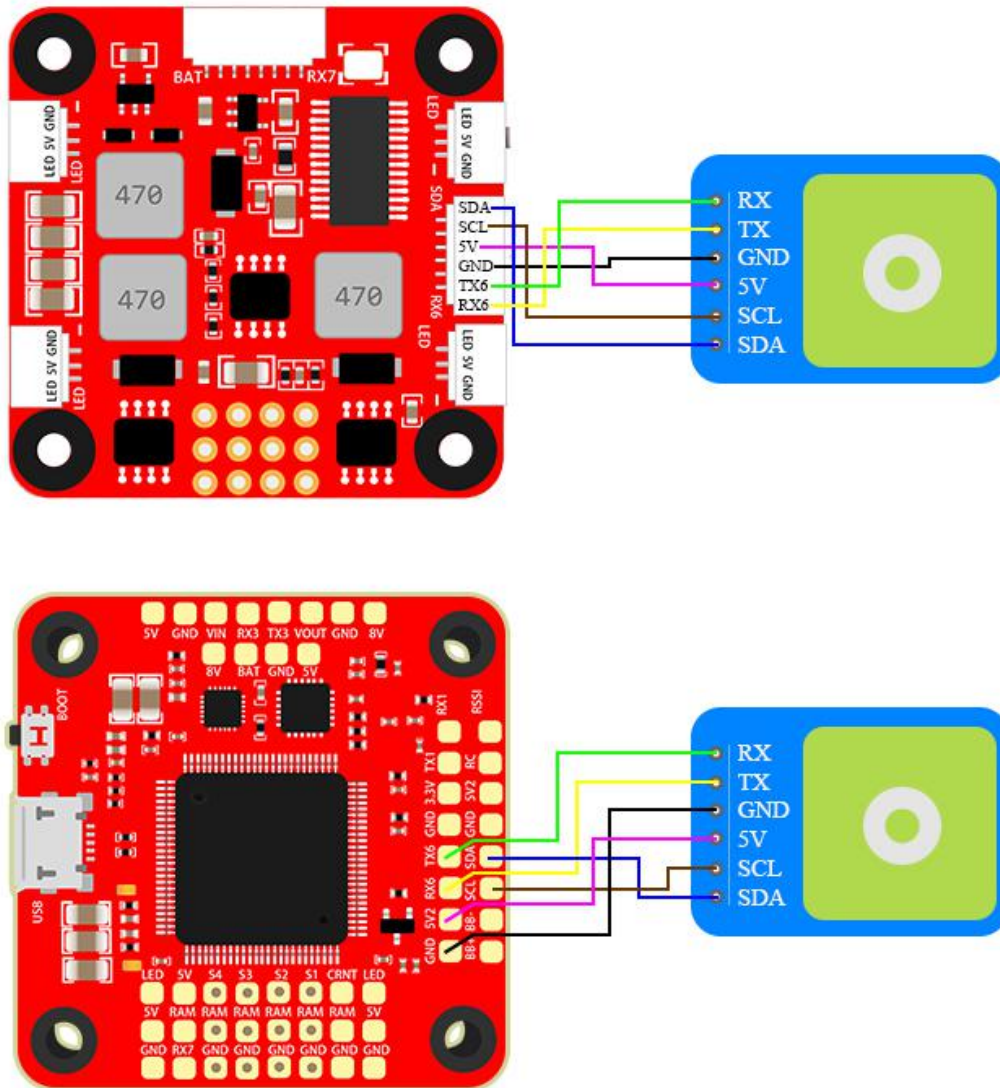

2. Open the GPS serial port

Identifier	Configuration/MSP	Serial Rx	Telemetry Output	Sensor Input	Peripherals
USB VCP	<input checked="" type="checkbox"/> 115200 ▾	<input type="checkbox"/>	Disabled ▾ AUTO ▾	Disabled ▾ AUTO ▾	Disabled ▾ AUTO ▾
UART1	<input type="checkbox"/> 115200 ▾	<input type="checkbox"/>	SmartPort ▾ AUTO ▾	Disabled ▾ AUTO ▾	Disabled ▾ AUTO ▾
UART2	<input type="checkbox"/> 115200 ▾	<input checked="" type="checkbox"/>	Disabled ▾ AUTO ▾	Disabled ▾ AUTO ▾	Disabled ▾ AUTO ▾
UART3	<input type="checkbox"/> 115200 ▾	<input type="checkbox"/>	Disabled ▾ AUTO ▾	Disabled ▾ AUTO ▾	IRC Tramp ▾ AUTO ▾
UART6	<input type="checkbox"/> 115200 ▾	<input type="checkbox"/>	Disabled ▾ AUTO ▾	GPS ▾ 9600 ▾	Disabled ▾ AUTO ▾
UART7	<input type="checkbox"/> 115200 ▾	<input type="checkbox"/>	Disabled ▾ AUTO ▾	ESC ▾ AUTO ▾	Disabled ▾ AUTO ▾

3. When using the GPS function, remember to configure the serial port (via the Ports tab).

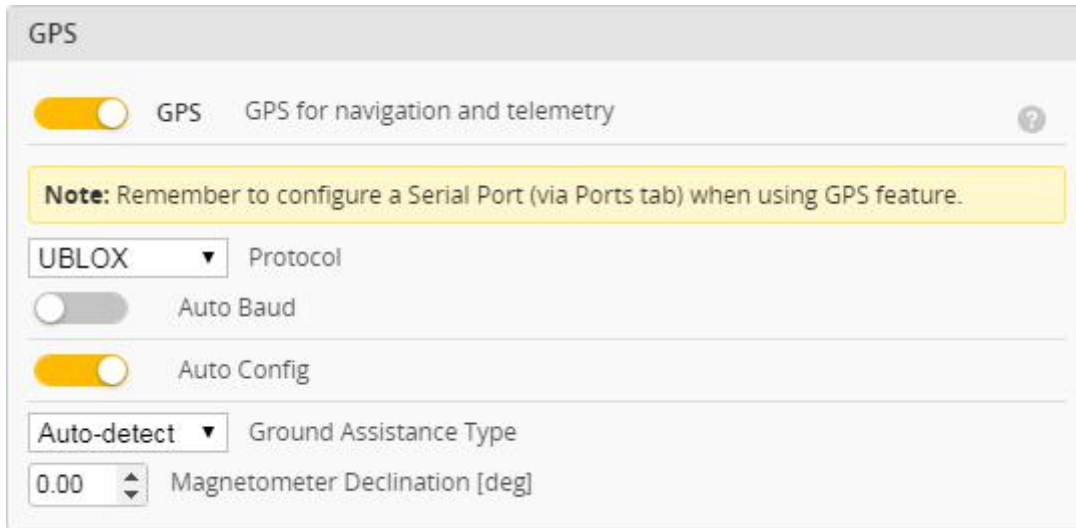

12. Check receiver signal

1. Click  Receiver. Check the remote control output signal

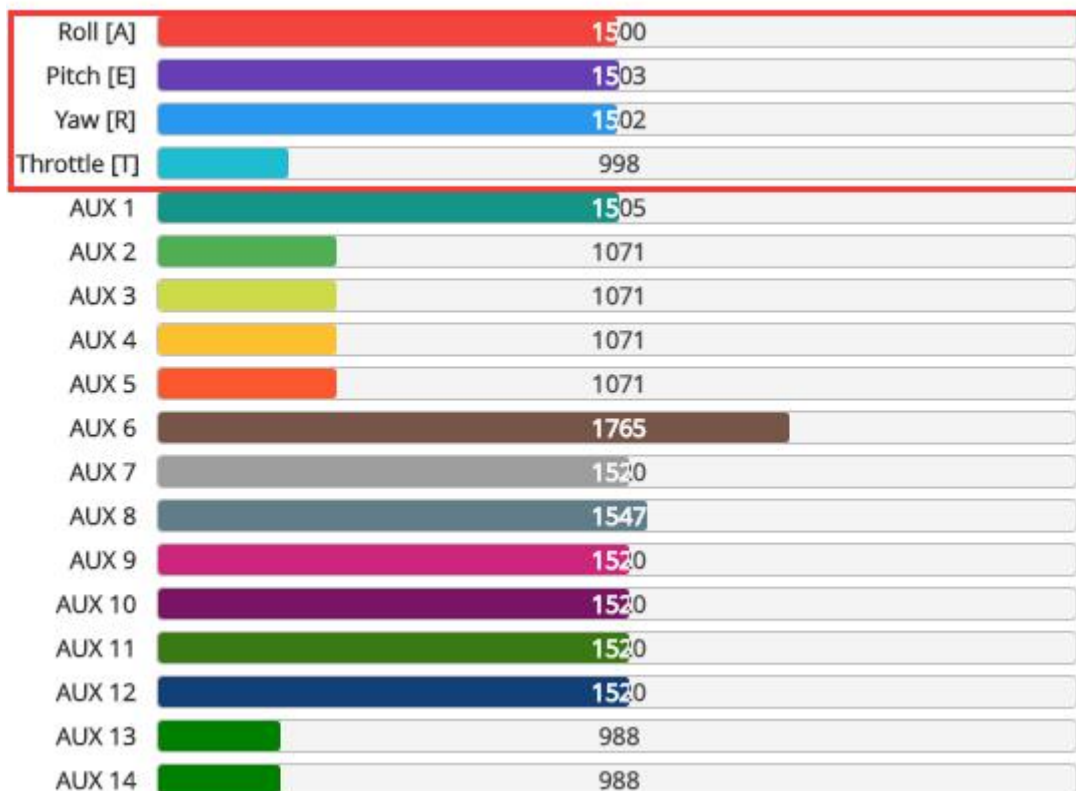

13. Select flight mode startup mode

1. Click  set up the function of remote control switch across the channel (below are for reference only)

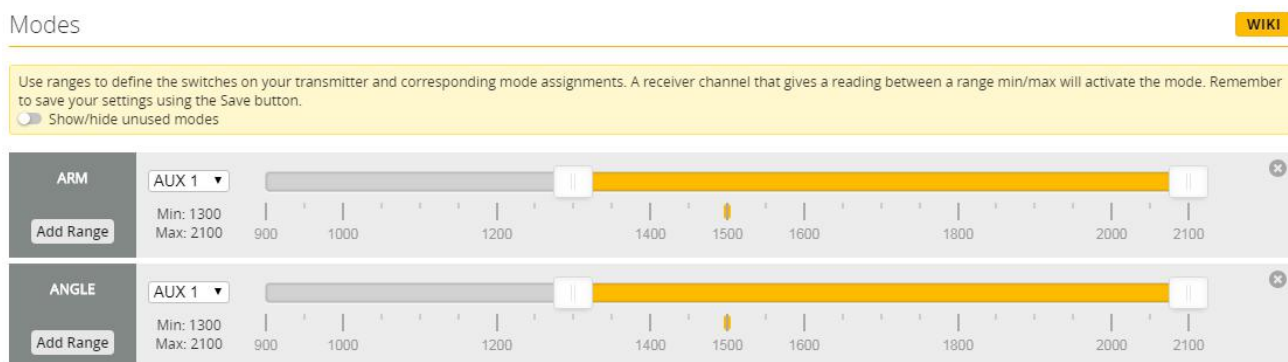

14. OSD settings

1. Click  the OSD Settings, according to the need to choose, drag the OSD schematic diagram of the parameters can be adjusted.



15. LED settings

1. Click  Configuration Turn on LED support



2. Click  LED Strip .Click  Wire Ordering Mode set according to need

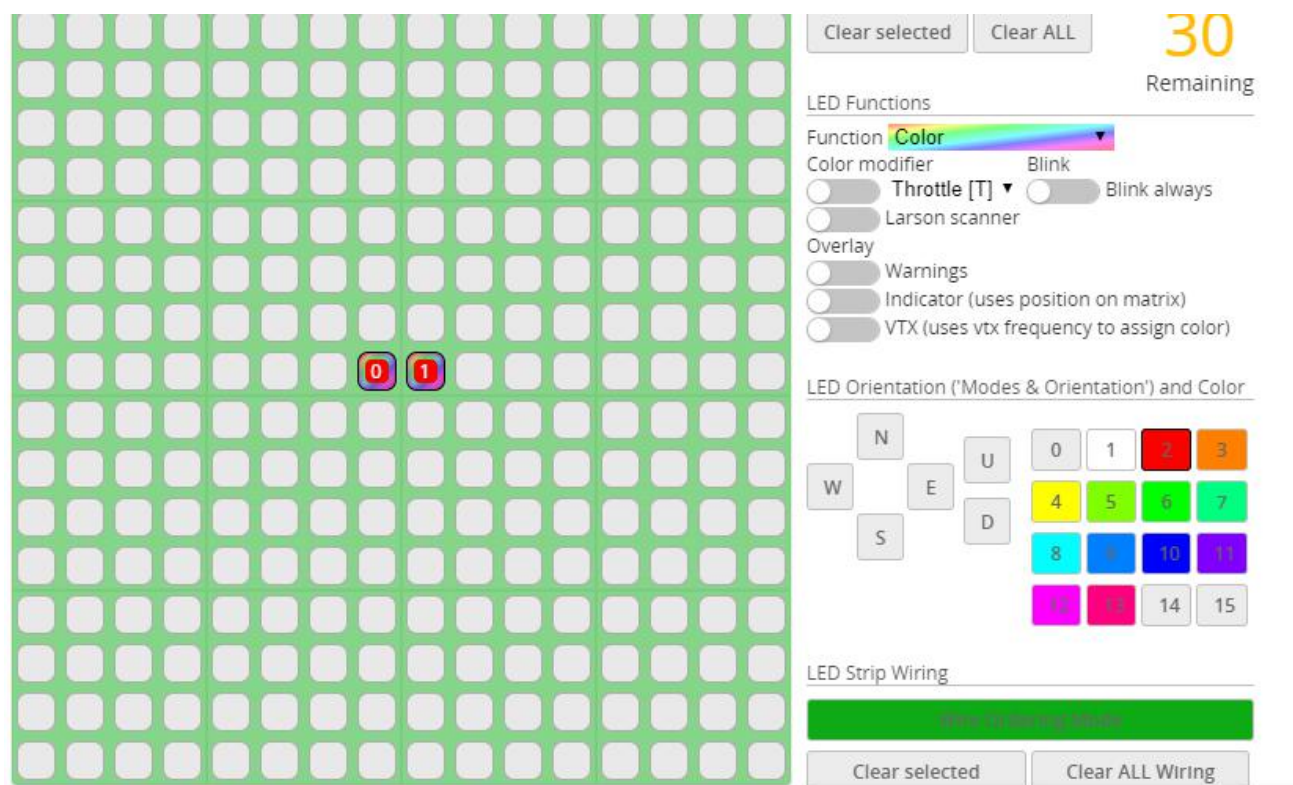

16. switching gyro

1. After connecting to the Betaflight ground station, open the  CLI page and enter “**get gyro_to_use**” and press Enter to view the currently used gyroscope. **First is MPU6000. SECOND is ICM20608** (Set the MPU6000 input: **gyro_to_use = FIRST**) (Set the ICM20608 input: **set gyro_to_use =SECOND**)

17.Troubleshooting

Warning:

Please read the cautions as follows, otherwise stability of your flight controller cannot be ensured, your flight controller will even get damaged.

- Keep focus on the polarity. Check carefully before power supply.
- Cut off the power when you connect, plug and pull anything.
- The refresh rate of PID and Gyroscope is up to 32K/16K.

after sales question:

1. After receiving the goods, it is found that the product can not be used normally. If the return to the factory is a quality problem, the repair service will be provided free of charge.
2. If the product is damaged due to improper operation, the repair service may be provided under the condition that the inspection can be repaired.
3. For domestic customers, please contact the after-sales service personnel. For overseas customers, please contact the official website for after-sales service.

Product daily problems

1.OSD garbled:

If you find garbled characters, please open Betaflight, click “OSD” .and click “Font Manager” clicks on “Upload Font” to update

1. When plugged in the battery, the aircraft does not pass the self-test

without "BBB" sound. There is only one sound.

Please check if the ESC agreement is correct

3.The spin of the aircraft keeps spinning

1. Please check if the propeller is correct

2. Please check if the motor direction is correct