

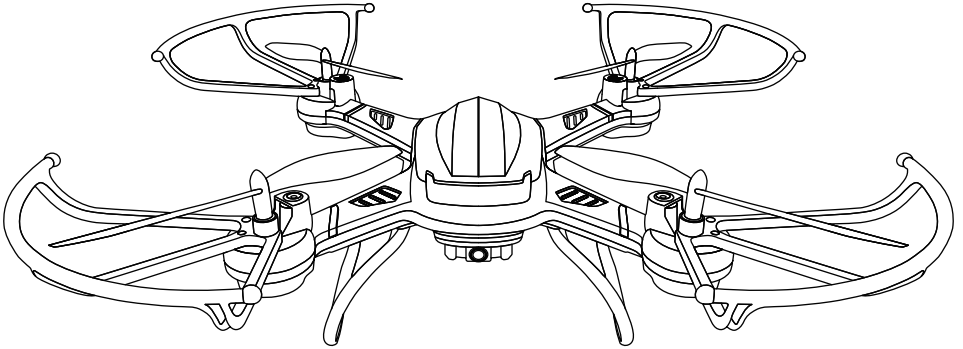

F181W

Instructions for use



usa@holystone.com (America)

ca@holystone.com (Canada)

eu@holystone.com (Europe)

jp@holystone.com (Japan)



+1(855) 888-6699



WWW.HOLYSTONE.COM

Contents

1. Preface	1
2. Warnings	2
3. Parts of the Drone	3
4. Drone Assembling	3
5. Transmitter Functions	4
6. Setting up the Transmitter	5
7. Charging the Battery	6
8. Assemble the Camera	6
9. Mode 2	7
10. Mode 1	8
11. Flying the Drone	9
- Pair the Drone	9
- Calibrate the Gyro	9
12. Flip Mode	10
13. Headless Mode / One Key Return	10
14. APP Instructions	11
15. Parts Name	14
16. Common Problems and Solutions	14
17. Additional Information	16

Preface

To make your experience with this drone as straightforward and convenient as possible, please read this instructions for use carefully before operation. Keep it safe for future reference and to ensure continued, safe and enjoyable use of your drone.

Important Statement

1. This product is not a toy, it is a high precision drone that integrates various electronic stability and control mechanisms. This drone requires careful and correct assembly and setup to ensure safe, accident free operation. This equipment should be operate in a safe and controlled manner at all times. Incorrect or dangerous operation may cause damage to the device or property, or cause serious injury to those in the vicinity.
2. This product is suitable for experienced drone pilots over 14 years of age.
3. In case of difficulties with any aspect of the product, operation or maintenance, please contact your local sales agent or contact customer support here at Holy Stone.

Safety Guidelines

This product is a mini RC drone that offers easy, controllable flight when in good working order, however there is also a significant risk to property and people if flown irresponsible or within confined spaces. Incorrect assembly or poor control by inexperienced pilots can result in damage to property or harm to people in an accident. Be fully aware of your surroundings when flying and always maintain complete control of the vehicle at all times.

1. Keep Your Distance

- a. Always fly in locations that are clear of any obstructions, such as buildings, poles, electrical wires, trees and so on.
- b. Never fly above or near other people or spectators.

2. Do not fly in adverse weather conditions

- a. Keep clear of moisture, fog, ice and excessive wind.
- b. Fly in good weather conditions only.

3. Use and maintain the product according to the instructions for use

- a. Operate this device legally in accordance with instructions provided and with local laws and regulations.
- b. Always use original parts made by Holy Stone for maintenance and repair.

4. Do not operate the device alone.

- a. If you are a new pilot, seek assistance from an experienced drone pilot as you learn.
- b. Have others around to help you fly at all times.

5. Safety First every time

- a. Always operate the drone within your limits as a pilot. If you are ill, disoriented, or unsure of how to effectively fly the drone, please seek help to avoid danger, damage or injury.

6. Keep clear of rotation parts

- a. During operation the rotors revolve extremely quickly, please avoid contact with the blades and ensure that foreign objects are kept clear of all moving parts.

7. Avoid exposure to excessive heat.

- a. Due the numerous material types used in construction, this drone is not suitable for exposure to heat. Please keep your device away from heat sources and avoid prolonged exposure to direct sunlight. High temperatures can distort the structure of the device, please check for suck damage before flying.

Warnings

1. The information and guidance within this package and instructions for use is important for the safe operation and maintenance of your drone. Please keep it safe for future reference.
2. You accept sole responsibility for any injury, loss or damage that result from your operation of the device.
3. Always follow the instructions when assembling or operating the drone. Always keep at least 2 meters between the user or viewers and the model to avoid risk of injury. Pay attention to the device at all times while in flight.
4. Neither Holy Stone nor any distributors or agents accept any responsibility for loss, injury or damage caused by incorrect operation of the drone.
5. This drone is not suitable for children under the age of 14, younger pilots should always operate the drone under the supervision of an adult.
6. Please ensure assembly instructions are followed correctly to ensure proper operation and performance of your drone.
7. This product contains small parts. To avoid any choking hazard, please keep this drone and all its components out of the reach of children.
8. You must not, under any circumstances, fly this drone over open water or near any public road to avoid risk of accident.
9. Keep all packaging materials away from children and dispose them safely.
10. The internals of the drone are not user serviceable, please do not attempt to disassemble this drone or replace any part of the drone, to avoid malfunctions during flight.
11. Please ensure batteries are fitted in the correct orientation as shown in these instructions.
12. You can access the transmitter battery compartment by unscrewing the screws on the battery cover. Insert batteries ensuring they are in the right orientation. Always replace battery cover and tighten the screw to secure before use.
13. Only use the charger provided with your drone for safety.
14. The charger is not a toy.
15. Always pay close attention to battery polarity when inserting any batteries to make sure they are fitted correctly.
16. Use either rechargeable or nonrechargeable 'AA' batteries in the transmitter. Do not mix battery types.
17. Use only recommended batteries in the transmitter, please remember that non-rechargeable batteries must not be charged.
18. For rechargeable batteries, always follow manufacturer's instructions for use and have adult supervision. Do not leave charging batteries unsupervised and as batteries get hot when charging, avoid any combustible material.
19. Avoid short circuits by fitting the batteries incorrectly, and do not crush or squash batteries as this carries a risk of explosion.
20. Do not mix new and old batteries as this can lead to unpredictable performance.
21. Dispose of used batteries carefully, do not litter.
22. The power socket must not be removed from this drone. Do not attempt to short circuit the connection socket.
23. When disposing of batteries, do not throw on fires, leave to decompose. Keep clear of heat sources and high temperatures at all time.
24. If the device is not going to be used for an extended period, remove batteries to prevent potential damage from battery leakage.
25. Care should be taken to keep your drone away from sources of magnetic interference of other electrical equipment to prevent signal issues during operation.
26. Keep clear of rotating parts and beware of loose clothing that could become entangled in the rotors causing injury.
27. Beware of the noise volume the drone produces. Keep your distance to avoid ear damage.
28. The charger socket uses a mini USB 5V connection.
29. Always use the product in compliance with local aviation radio rules and comply with local authorities should they require you to refrain from operating at any time.

Maintenance

1. Clean the product after each use with a clean, soft cloth.
2. Avoid prolonged exposure to direct sunlight and avoid heat buildup in the drone.
3. This device is not waterproof and must not be submerged in water under any circumstances. Failure to maintain the device completely dry will result in the failure of the unit.
4. Check the charging plug and other accessories for signs of damage frequently. If any parts of the device is damaged refrain from flying until maintenance can be carried out.

Parts of the Drone

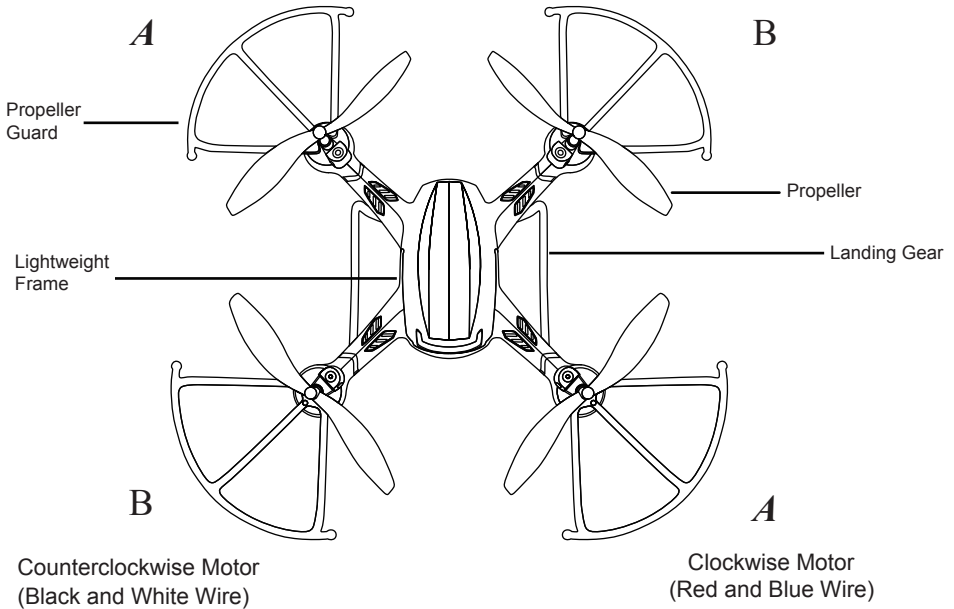

Please Note: letter **A** or **B** is printed on each propeller; Make sure all propellers are assembled in correct orientation according to the image above.

Drone Assembling

1. A small screwdriver is needed to assemble the landing gear and propeller guards.
2. Insert the two landing gears into the bracket holes at the bottom of the drone, then secure with the four screws tightly.
3. Insert all four propeller guards into the holes located on the motor base, secure with the four screws tightly.

(pic.1)

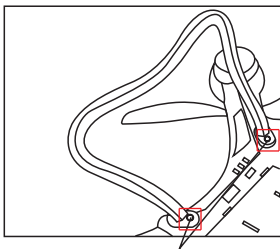

Screw position

(pic.2)

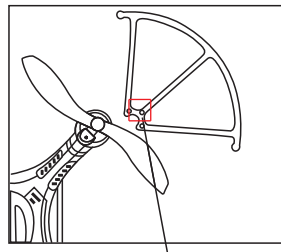

Screw position

Transmitter Functions

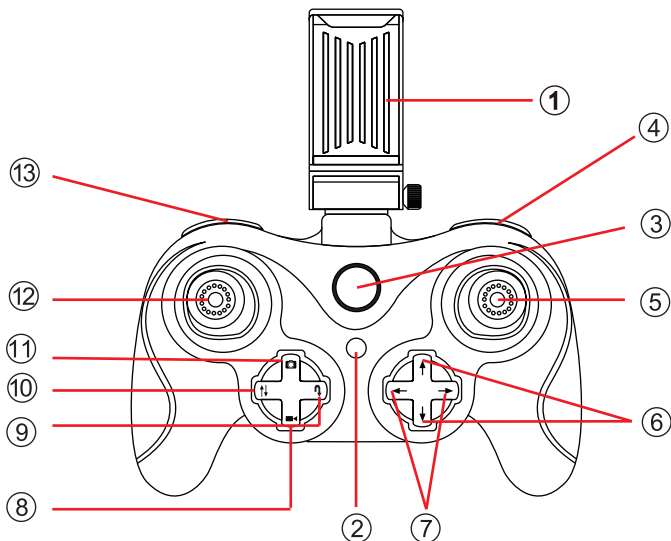

① **Smart Phone Holder**

② **Power Indicator**

③ **Power On/Off**

④ **Flip Mode:** When pressed, the Power Indicator on the transmitter will beep continuously.

Fly the drone at least 3 meters above the ground, then, push the right control lever to any direction and release. The drone will roll over in the corresponding direction. Repeat the movement to roll again.

⑤ **Direction Stick:** Forward/Backward/ Left/Right.

⑥ **Forward/Backward Trimmer:** If the entire body of the drone drifts forward or backward after take off, use this button to correct it. (Press up arrow if it drifts back; press down arrow if it drift forward).

⑦ **Left/Right Trimmer:** If the entire body of the drone drifts left or right when take off, use this button to correct it. (Press right arrow if it drifts left; press left arrow if it drifts right).

⑧ **Take Video:** Press this button to start recording a video, press it again to end and save the video.

(Don't take photos when camera is recording video.)

⑨ **Headless Mode/One Key Return:**

Headless Mode makes it easier to control the steering of the drone. In Headless Mode, the direction of the pilot face would be the forward direction. When pairing the drone, make sure that the head of the drone is facing forward while the tail is facing towards the pilot.

(For more details, please refer page 10)

- ⑩ **Engine Start/ Stop:** Press this button to start the motors and get ready for take off. When flying, press this button to land.
- ⑪ **Take Photo:** Press this button to take photos. The camera will take a photo every time you press this button.
- ⑫ **Throttle Stick:** Push up on the joystick to increase throttle and ascend. Push down on the joystick to decrease throttle or descend.
- ⑬ **Speed Mode:** Low/Med/High/Expert

Important Tips:

1. The model is equipped with powerful and responsive motors. If you are beginner, please fly the drone on a soft ground, like a lawn or above a carpet. Throttle up slowly and fly with low speed to avoid damage from losing control.
2. The motors and circuit board will heat up with use. Take a 10 minutes cool down break between flights to ensure your parts last as long as possible.
3. Pay attention to the wires which are connected to the circuit board and protect them from being pulled loose or even disconnected from the circuit board (especially when one is disconnecting the battery).

Setting Up the Transmitter

1. Open the battery cover on the back of the transmitter, install 4 AA batteries according to electrode instruction. Do Not mix new and old batteries, and Do NOT use different types of batteries.(Batteries are not included in the box)

Note: Always pay close attention to battery polarity when inserting any batteries to make sure they are fitted correctly.

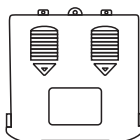
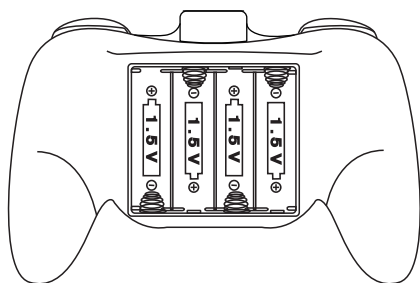

Battery cover



4 AA batteries

(Not included)

2. This model uses Wi-Fi and HD camera to display real-time images on smartphone. To do this, you need a smartphone with Android or iOS system and the correct APP installed.

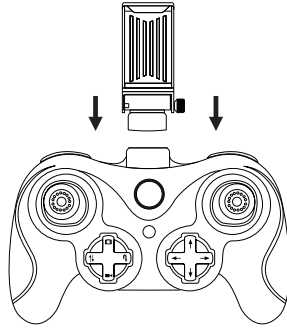

(Assemble the phone holder)

Charging the battery

Insert the USB charging cable (including in the box) into the USB port (5V/0.5-1A). The red indicator light will turn on. Then, connect the USB charging cable to the battery or the charging plug at the bottom of the drone (marked as “CHA”). The charger indicator will turn off, indicating that the drone is charging. The indicator will turn on again once the battery is fully charged. It takes around 100 minutes to fully charge the battery.

Note: Disconnect the charger once the battery has been fully charged.

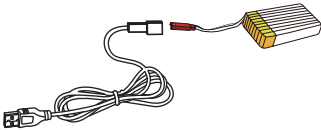

Insert the USB charger cable into the battery plug.

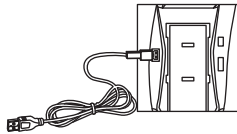

Insert the USB charger cable into the charging plug which is at the bottom of the drone.

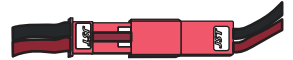

To avoid short circuit, please plug in the battery as the picture above.

Assemble the Camera

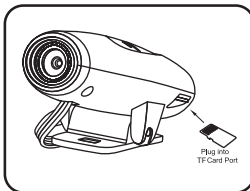

1. Insert the TF card into the card slot of the camera.

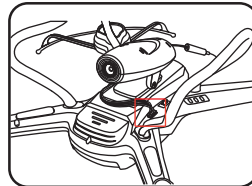

2. Plug the camera wire into the slot on the bottom of the drone.

Transmitter Operation Mode

In order to meet the needs and preferences of any pilot, this drone offers two modes of controlling the device that have been defined by industry standards.

1. Power on the transmitter, Left hand throttle MODE 2 will be default setting.

(Recoomended Mode!)

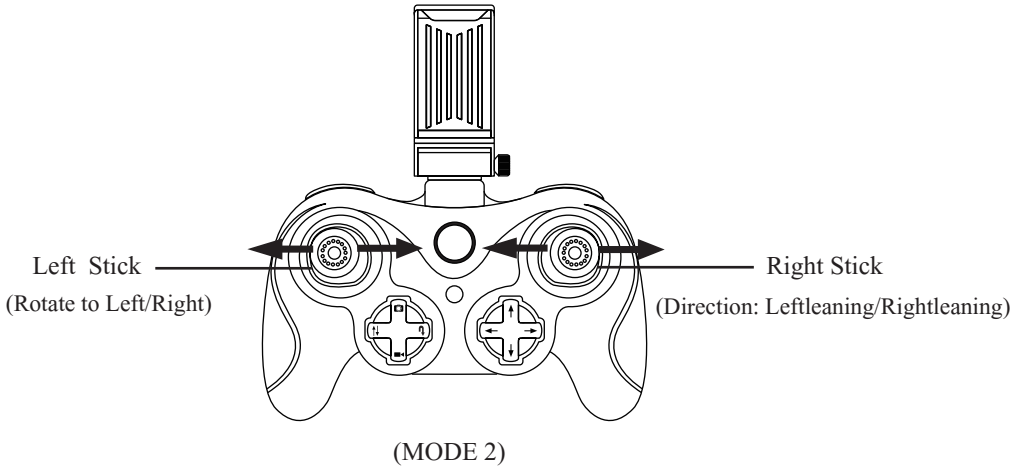
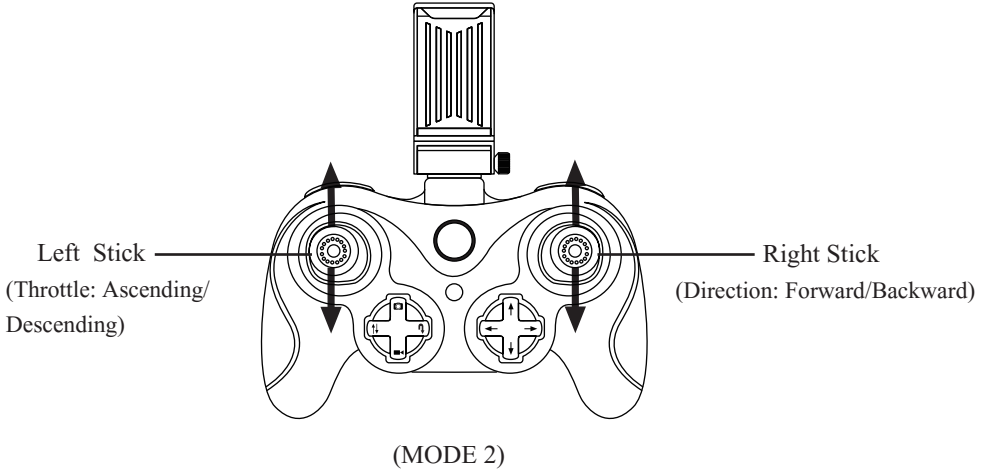

2 . To enter MODE 1, turn on the transmitter while holding the upleft button.
(Please do not release the upleft button until the transmitter is powered on)

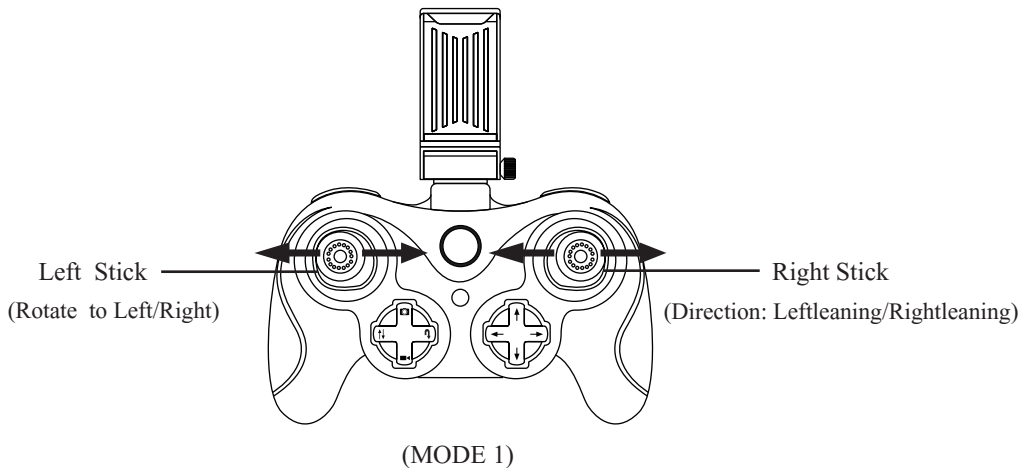
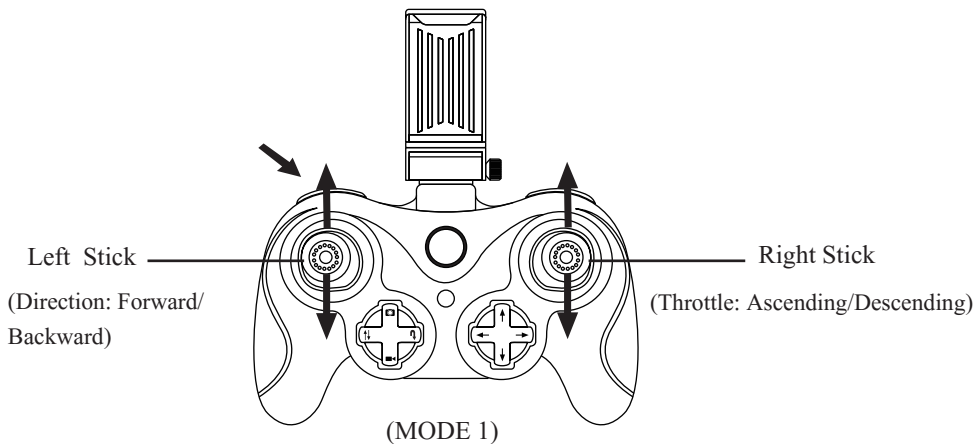

Flying the Drone

All of the following operations on this manual are taking mode 2 for example.

1. Preparing:

- Fly the drone in a spacious indoors area, or an outdoors area free of obstacles, rain, snow, animals, and people. When flying outdoors, please choose a windless environment.
- Install the battery into the battery compartment on the drone and connect it.

2. Pair the drone:

- Power on the drone and the transmitter, then, place the drone on a level surface.
- Push the throttle joystick up then down. If done correctly, the transmitter sound will beep, and the LED indicators will turn solid, indicating that the transmitter is connected to the drone.

3. Calibrate the gyro:

- After pairing the transmitter, hold the flip button on the upper right shoulder of the transmitter.
- Push both left and right sticks to the bottom left until the LED lights of the drone start flashing and then turn solid.

(Note: This operations is to ensure a stable flight, we suggest the pilot calibrate the gyro before each flight and after a crash.)

4. Start to fly:

- Press the Engine Start / Stop button, the propellers begin to spin, and the drone is ready to take off.
 - Throttle up carefully and the drone will take off and will hover in the sky if you release left and right joysticks at the same time.
 - When flying, press the Engine Start / Stop button and the drone will land.
 - If you need to urgently stop the motors, push the left stick to the bottom left, and push the right stick to the bottom right at the same time for about 1 second.(Shown as picture below)
- (Note: Only stop motors mid-flight in emergency situation when doing so can reduce the risk of damage or injury.)

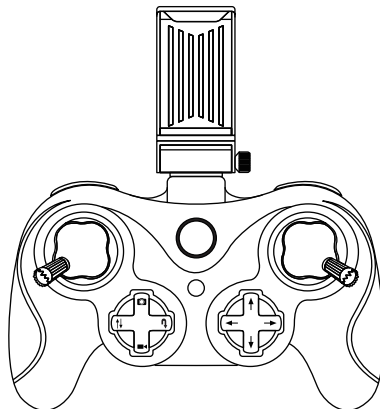

Emergency Landing

Important Tips:

The range of the communication between the drone and the transmitter is about 100 meters, and the range of Wi-Fi signal is about 30~50 meters. The range was measured on a wide open field and a windless sunny day, no Wi-Fi signal or radio signal interference. If the drone goes beyond the range of the transmitter or phone, it will attempt to out of control or drop from sky by itself.

Flip Mode

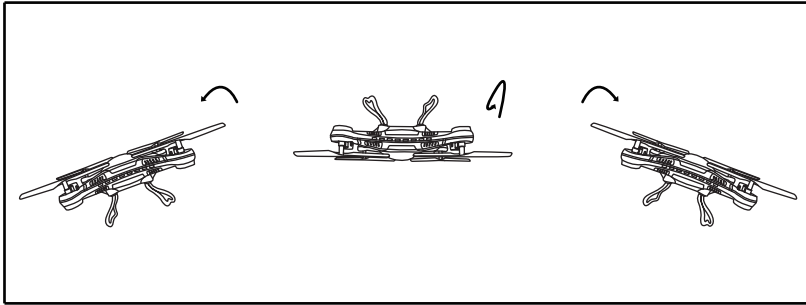

When you are familiar with all the basic actions, you can try this amazing flip mode. When you are flying the drone at least 3 meters high, press the flip button located on the upper right corner of the transmitter, the drone will start beeping; then, push the right control lever either forward/backward/ left/ or right. and the drone will do a flip towards the corresponding direction

Caution: The drone will flip best when the battery is fully charged.

Headless Mode / One Key Return

1. Place the drone in front of the pilot, before the pilot pairs the drone. Make sure the head of the drone faces in the same direction as the pilot, and the tail faces towards the pilot.
2. Push the left joystick up then down to bind the transmitter to the drone.
3. Press the Headless Mode button on the transmitter to enter Headless Mode. The lights of the drone will start flashing and the drone sounds will beep constantly. Then the drone will fly back to the pilot directly. This is One Key Return function.
4. Move the right joystick to any direction to operate the drone in Headless Mode and the drone will exit the One Key Return function.
5. Press the Headless Mode button again to exit Headless Mode.

Tips:(Important!)

1. When pairing the transmitter to the drone, make sure the head of the drone is facing forward, and the tail of the drone is facing towards the pilot (and the transmitter) as seen in the diagram below.
2. When flying in Headless Mode/ One Key Return, the pilot should not move around. This is because the drone will fly relative to the point where it was paired(to the transmitter), not relative to where the transmitter is.
3. When using Headless Mode, it is important to stay stationary and facing the same direction as you were when the drone and transmitter were paired.

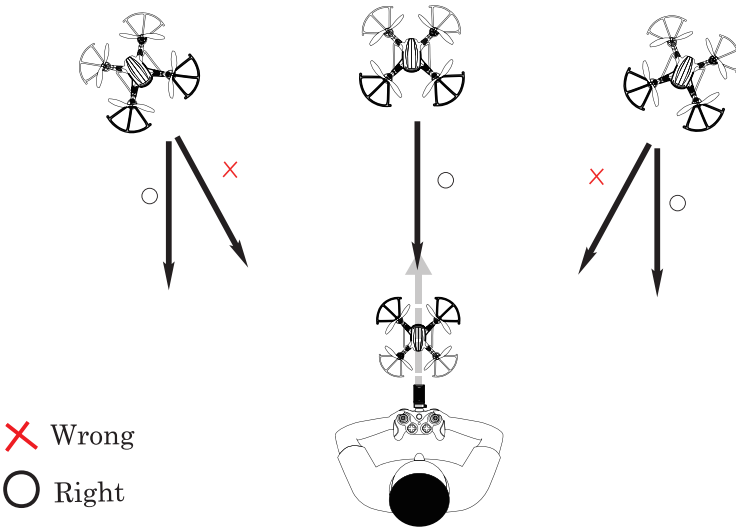

The APP Installation

Scan the relevant code with your smart phone, download and install the “Deerc FPV ” APP.

Required Operating Systems: iOS 8.0 or later / Android 4.1.2 or later.



Android Worldwide



iOS System

APP Functions

Power on the drone. On your phone, go into settings, Wi-Fi, then connect to “HolyStone FPV***”, which corresponds to the camera Wi-Fi connection. When successfully connected, exit settings and open the APP “Deerc FPV”, press the “PLAY” icon to enter the control interface to see real-time images from the drone.



Open the APP
“Deerc FPV”



Click the “PLAY” icon

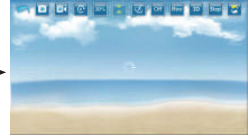

Real-time image or video will
be shown on the mobile screen

1. Take Photo: Click the Take Photo icon to take photos.
2. Record Video: Click the Record Video icon to record videos.

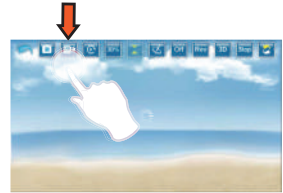

3. All the images and videos are saved to the TF card (make sure it is inserted into the camera). Push the TF card gently to take it out, then insert the TF card into the card reader and insert it into the USB outlet of the computer to read the data of aerial photography from “My computer” --- “Portable hard disk” . The files could be found saved in the folders of the “Deerc FPV” APP and the mobile phone.

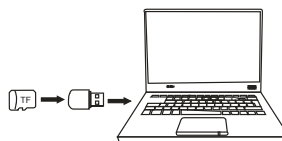
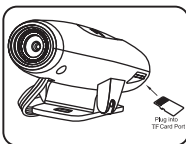

4. The use is shown as below. In the Video folder, you can slide leftward the selected file to save or delete it.

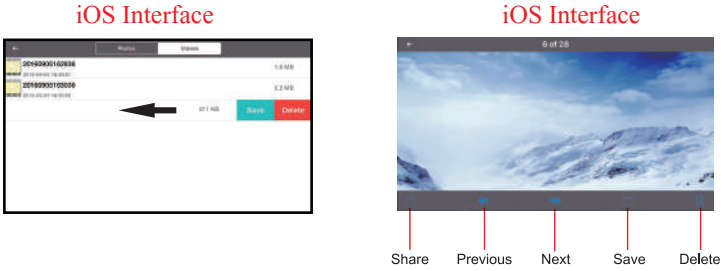

APP Control

The drone can be controlled with the APP without using a transmitter. Hold the mobile phone horizontally when using the Gravity Sensor Mode.

(There may be a slight delay in the response of the drone when using this control method.)

For more details, please click “ ? ” icon on the APP interface .



Mobile phone control steps:



Tips: Turn off the transmitter before you control the drone using the phone.

Parts Name

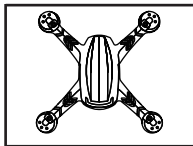

1. Upper Cover

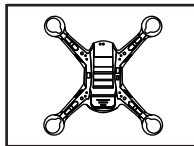

2. Lower Cover

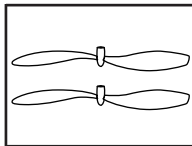

3. CW Propellers

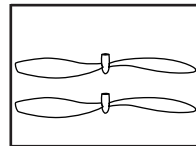

4. CCW Propellers



5. CW Motors
(Red and Blue wire)



6. CCW Motor
(White and Black wire)

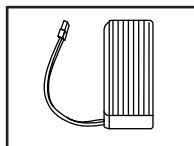

7. Battery

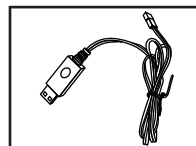

8. USB Charging
Cable

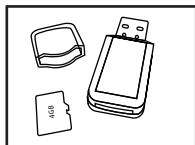

9. TF Card and
Card Reader

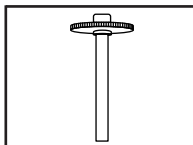

10. Gear Assembly

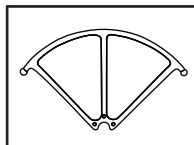

11. Propeller Guard

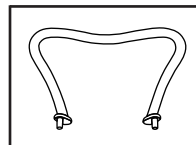

12. Landing Gear

Common Problems and Solutions

Problems	Reasons	Solutions
The lights on the drone are flashing, but the drone is not responding.	<ol style="list-style-type: none"> 1. Insufficient battery power. 2. Transmitter is not connected to the drone. 3. Unbalanced landing position. 4. Drone cannot be paired because the drone has been on for a long period of time. 	<ol style="list-style-type: none"> 1. Fully charge the battery. 2. Turn off the drone and transmitter, then, reconnect them by turning them on again. 3. Place the drone in a level surface when pairing. 4. Turn off the drone and transmitter, then, turn them on again to pairing.
The propellers spin, but the drone doesn't fly.	<ol style="list-style-type: none"> 1. Insufficient battery power. 2. Propellers not installed in the correct orientation. 3. Damaged propellers. 4. Something caught in the propellers or gears. 	<ol style="list-style-type: none"> 1. Fully charge the battery. 2. Check the letter "A" and "B" which printed on the propellers correspond to the diagram on page 3 of this manual. 3. Replace old propellers with new ones. 4. Ensure gears and propellers are clear and there is nothing caught in them.

Problems	Reasons	Solutions
The drone doesn't fly properly after a crash	<ol style="list-style-type: none"> 1. Propellers not installed in the correct positions. 2. Damaged propellers. 3. The gyro has lost calibration. 4. Propellers have hit the propeller guard. 5. Wire or circuit board broken. 6. Motors burnt out. 	<ol style="list-style-type: none"> 1. Check the propeller order. 2. Replace propellers with new ones. 3. Reset the gyro. Press trim buttons to fine tune the direction. 4. Make sure propellers are work well. 5. Replace the circuit board. 6. Replace the motors.
One Key Return button doesn't work properly.	<ol style="list-style-type: none"> 1. Pilot changed position/ location after connecting the transmitter to the drone. 2. Transmitter button doesn't function. 3. Battery low on charge. 	<ol style="list-style-type: none"> 1. Reconnect the transmitter and the drone for use with the One Key Return, and ensure that you don't move or turn after doing so. 2. Use another transmitter. 3. Fully charge the battery, or use a new battery.
Photo or Video doesn't work properly.	<ol style="list-style-type: none"> 1. Insufficient battery power. 2. The camera is broken. 3. TF card is full. 	<ol style="list-style-type: none"> 1. Fully charge battery or use new battery. 2. Replace the camera. 3. Remove files from TF card, or use and empty TF card.
Image can't be displayed on computer	<ol style="list-style-type: none"> 1. Media player does not support the file format. 2. Video is not successfully recorded. 	<ol style="list-style-type: none"> 1. Try new media player(such as VLC Media Player). 2. Press video button second times to stop record and save the file.

Please Note:

When one propeller does not spin while the others do, or the propeller spins at a different speed rate, the motor of this propeller might be burnt out. The motors and circuit board will heat up with use. Take a 10 minutes cool down break between flights to ensure your parts last as long as possible.

The drone has a low battery alert to allow the pilot time to land the drone in a safe, controlled manner. When the battery level gets low, the LED lights will start to blink. Land in a safe location as soon as possible to prevent a crash or over discharging the battery.

FCC Information

This device complies with Part 15 of the FCC Rules. Operation is subject to the following two conditions:

(1) This device may not cause harmful interference. (2) This device must accept any interference received, including interference that may cause undesired operation.

NOTE: This equipment has been tested and found to comply with the limits for a Class B digital device, pursuant to Part 15 of the FCC Rules. These limits are designed to provide reasonable protection against harmful interference in a residential installation. This equipment generates uses and can radiate radio frequency energy and, if not installed and used in accordance with the instructions, may cause harmful interference to radio communications. However, there is no guarantee that interference will not occur in a particular installation. If this equipment does cause harmful interference to radio or television reception, which can be determined by turning the equipment off and on, the user is encouraged to try to correct the interference by one or more of the following measures:

---Reorient or relocate the receiving antenna.

---Increase the separation between the equipment and receiver.

---Connect the equipment into an outlet on a circuit different from that to which the receiver is connected.

---Consult the dealer or an experienced radio/TV technician for help.

WARNING: Changes or modifications not expressly approved by the party responsible for compliance could void the user's authority to operate the equipment.

RF Exposure

The equipment complies with FCC radiation exposure limits set forth for an uncontrolled environment. This device should be installed and operated with minimum distance 20cm between the radiator & your body.

IC Notice:

This device complies with Canada Industry licence-exempt RSS standard(s). Operation is subject to the following two conditions:

- (1) this device may not cause interference; and
- (2) this device must accept any interference. Including interference that may cause undesired operation of the device.

CAN ICES-3 (B)

Avis d'Industrie Canada

Le présent appareil est conforme aux CNR d'industrie Canada applicables aux appareils radio exempts de licence L'exploitation est autorisée aux deux conditions suivantes:

- 1) l'appareil ne doit pas produire de brouillage; et
- 2) l'utilisateur de l'appareil doit accepter le brouillage radioélectrique subi même si le brouillage est susceptible d'empêcher le fonctionnement normal de l'appareil.

Cet appareil numérique de la classe B est conforme à la norme NMB-003 du Canada.

CAN NMB-3 (B)

RF Exposure

Radiation Exposure Statement:

This equipment complies with IC radiation exposure limits set forth for an uncontrolled environment.

This equipment should be installed and operated with minimum distance 20cm between the radiator & your body.

Déclaration d'exposition aux radiations:

Cet équipement est conforme aux limites d'exposition aux rayonnements IC établies pour un environnement non contrôlé. Cet équipement doit être installé et utilisé avec un minimum de 20 cm de distance entre la source de rayonnement et votre corps.

RF Power(EIRP):10dBm (2413MHz ~ 2461 MHz)

HOW TO RECYCLE THIS PRODUCT

This symbol on the product or its documentation indicates that it must not be disposed of with household waste.

Uncontrolled waste disposal may harm the environment or human health.

Please separate your device from other types of waste to recycle it responsibly. This will help to foster the sustainable re-use of material resources.

We invite you to contact your retailer or inquire at your local town hall to find out where and how the drone can be recycled.



BATTERY WARNING:

- 1.Failure to follow all the instructions may result in serious injury, irreparable damage to the battery and may cause a fire, smoke or explosion.
- 2.Always check the battery's condition before charging or using it.
- 3.Replace the battery if it has been dropped, or in case of odour, overheating, discoloration, deformation or leakage.
- 4.Never use anything other than the approval LiPo charger the battery. Always use a balancing charger for LiPo cells or a LiPo cell balancer. It is recommended that you do not to use any other charger than the one provided with the product.
- 5.The battery temperature must never exceed 60°C(140°F) otherwise the battery could be damaged or ignite.
- 6.Never charger on a flammable surface, near flammable products or inside a vehicle (preferably place the battery in a non-flammable and non-conductive container).
- 7.Never leave the battery unattended during the charging process. Never disassemble or modify the housing's wiring, or puncture the cells. Always ensure that the charger output voltage corresponds to the voltage of the battery. Do not short circuit the batteries.
8. Never expose the LiPo battery to moisture or direct sunlight, or store it in a place where temperatures could exceed 60°C(car in the sun, for example).
- 9.Always keep it out of reach of children.
- 10.Improper battery use may result in a fire, explosion or other hazard.
- 11.Non-rechargeable batteries are not to be recharged. Rechargeable batteries are only to be charged under adult supervision.
- 12.Different types of batteries or new and used batteries are not to be mixed.
- 13.Batteries are to be inserted with the correct polarity.
- 14.The supply terminals are not to be short-circuited. Regular examination of transformer or battery charger for any damage to their cord, plug, enclosure and other parts and they must not be used until the damage has been repaired.
- 15.The packaging has to be kept since it contains important information.
- 16.The toy is only to be connected to Class II equipment bearing the symbol. 

Caution

- 1.The max operating of the EUT is 45°C. and shouldn't be lower than -10°C.
- 2.The device complies with RF specifications when the device used at 0mm form your body.
- 3.Declaration of Conformity

We, Xiamen Huoshiquan Import & Export CO., LTD

hereby, declare that the essential requirements compliance with the Directive 2014/53/EU, the RoHS Directive 2011/65/EU and Safety Directive 2009/48/EC have been fully fulfilled on our product with indication below:

Product Name: REMOTE CONTROL MODEL/RADIO CONTROLLED
HELICOPTER

Model/Mark: F181/HOLYSTONE

http://www.holystone.com/Download/CE/F181C_EU_DOC.pdf

MAILLING ADDRESS:

Xiamen Huoshiquan Import & Export CO., LTD.

Room 703, No. 813-2 Xiahe Road, Siming District,

Xiamen, China

+1(855)888-6699



Made in China