

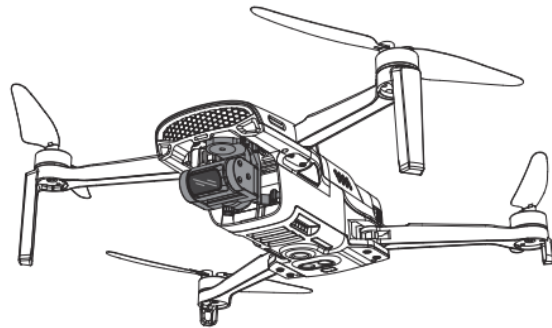

HS900

User Manual
Gebrauchsanweisung | V 3.0



+1(833)766-4733
www.holystone.com

usa@holystone.com (USA)
eu@holystone.com (EU)

English

01-47

Deutsch

48-92

CONTENTS

1

Product Profile

- 01 Package Contents
- 02 Diagram of the Drone
- 03 Diagram of the Transmitter

2

Operation Guide

- 08 Checking the Battery Level
- 09 Charging
- 11 Pre-Flight Preparations
- 17 Flight
- 26 Flight Functions
- 38 Additional Instructions

3

Appendix

- 40 Specifications
- 41 Contact Us
- 42 Troubleshooting
- 43 Compliance Information

Reading Guidance

Icon

"⚠️" essential precautions. "💡" tips for operation and usage.

Recommended Steps

Our product offers both tutorial videos and the following resources:

- Disclaimer and Safety Guidelines
- Quick Start Guide
- User Manual

For a smooth start, we suggest watching the tutorial videos and reviewing the "Disclaimer and Safety Guidelines" first. Then, familiarize yourself with the basics through the "Quick Start Guide". For a comprehensive understanding, delve into the "User Manual".

Access tutorial Videos

To ensure you're using the product safely and correctly, scan the QR code to view our tutorial videos.



Download the HS Sirius App

The HS Sirius APP is compatible with Android 8.0 and higher, HarmonyOS 2.0 and higher, as well as Apple iOS 11.0 and higher, Recommended only for smartphones, as other devices may have reduced compatibility. For Android or HarmonyOS devices, you can download and install the app by opening your web browser and going to <https://fly.holy-stone.com/a/> or by scanning the QR code provided. Android users can also find the HS Sirius APP on Google Play. Apple iOS users can download and install the app from the Apple App Store by searching for HS Sirius.



***Please ensure that all permissions requested by the app are granted.**

1.1 Package Contents >>

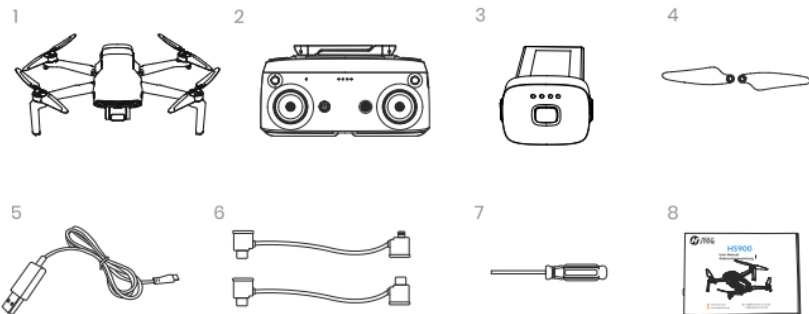

- 1 Drone
- 2 Transmitter
- 3 Drone Battery
- 4 Propellers
- 5 USB Charging Cable
- 6 Connection Cable
- 7 Screwdriver
- 8 User Manual

1.2 Diagram of the Drone >>

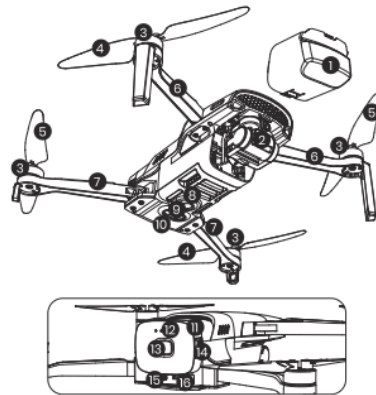

- 1 Gimbal Cover (Remove before flight)
- 2 Gimbal Camera
- 3 Brushless Motor
- 4 Propeller (↻)
- 5 Propeller (↻)
- 6 Front Arm
- 7 Rear Arm
- 8 Downward Vision System
- 9 TOF Ranging Sensor
- 10 Drone Status Light
- 11 Battery
- 12 Battery Light
- 13 Power Button
- 14 Battery Snap
- 15 Type-C Charging Port
- 16 TF-Card Slot

- 💡 · Turning on/off: Press once, then press and hold the power button until all four battery lights turn on/off.
- The drone status indicator displays the status of the flight control system.

1.3 Diagram of the Transmitter >>

The Transmitter

• Front:

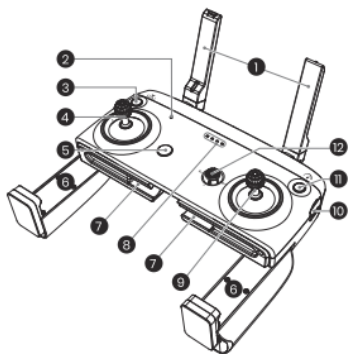

• Top:

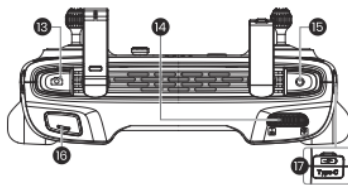

- | | |
|-------------------------------|---|
| 1 Antennas | 2 System Status Light |
| 3 Return to Home (RTH) | 4 Left Joystick |
| 5 Power Button | 6 Foldable Handle |
| 7 Storage Slots for Joysticks | 8 Transmitter Battery Light |
| 9 Right Joystick | 10 Type-C port |
| 11 Speed Switch | 12 Secondary Joystick |
| 13 Photo Button | 14 Gimbal Dial (Gimbal Tilt Adjustment) |
| 15 Record Button | 16 Custom Function Button |
| 17 Charging Port | |

 Turning on/off: Press once then press and hold the power button of the transmitter.

1.3 Diagram of the Transmitter >>

Joystick Mode

Changing joystick modes: Ensure that the transmitter is paired with your mobile device. Then, in the app, tap "Settings" → "Control" → "Joystick Mode" to access other modes.

- **MODE 2 :** (The default setting, i.e., left joystick as the throttle joystick.)

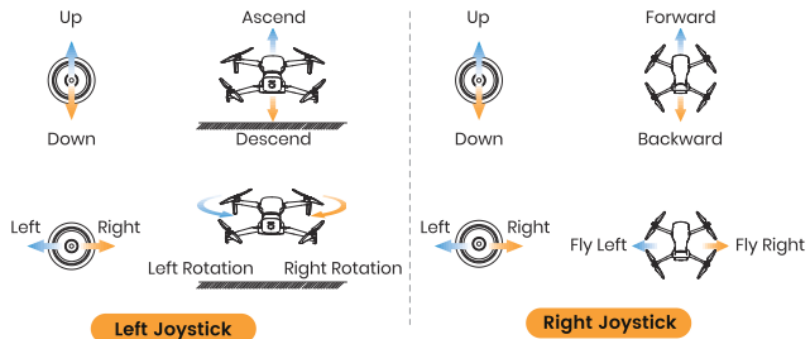

- **MODE 1 :**

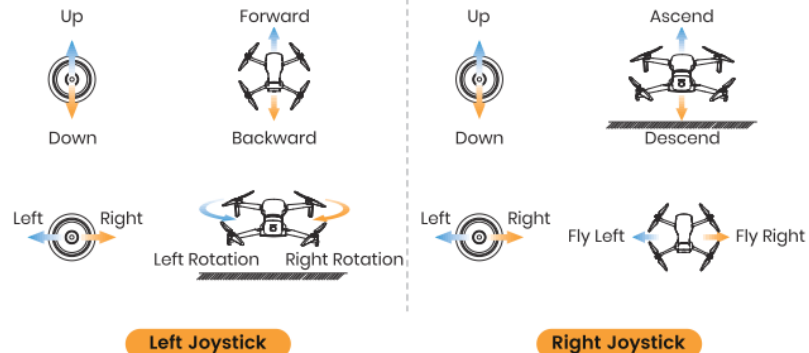

1.3 Diagram of the Transmitter >>

Secondary Joystick

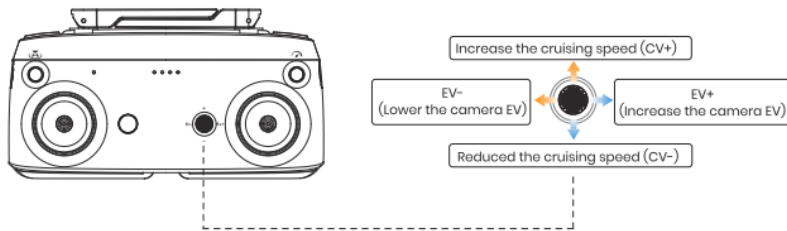

EV: Exposure value, i.e., brightness of the screen.
CV: Cruising speed.

2.1 Checking the Battery Level >>

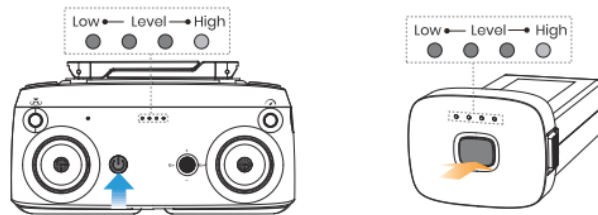

Transmitter: Press the power button once. Its battery lights illuminate to indicate the battery level.

Drone: Press the power button of battery once. The lights illuminate to indicate the battery level.

2.2 Charging >>

Charging the Drone Battery

- ⚠ Before charging, please read the instructions in the "Battery Safety" section of the "Disclaimer and Safety Guidelines" carefully!
- DO NOT charge a battery immediately after a flight as the temperature may be too high. Please wait until it cools down to room temperature before charging again.
- Please use the original charging cable to charge the battery.

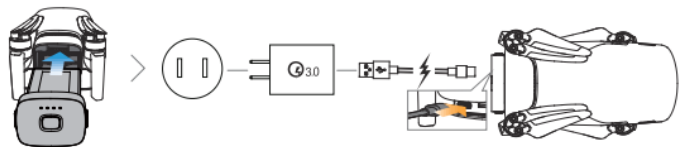

To charge the drone battery, it needs to be installed in the drone. This drone features a standard Type-C port, which is compatible with the standard Type-C interface. For charging, use a USB charger that supports the QC3.0 protocol, similar to chargers for smartphones, cameras, and other digital devices. Charging is not possible when the drone is powered on, and the drone cannot be turned on while it's charging.

The battery lights blink green to signal the commencement of charging and turn off once the battery is fully charged. The fastest charging time is 80 minutes.

2.2 Charging >>

Charging the Transmitter

- ⚠ Before charging, please read the instructions in the "Battery Safety" section of the "Disclaimer and Safety Guidelines" carefully!
- Please use the original charging cable to charge the battery.

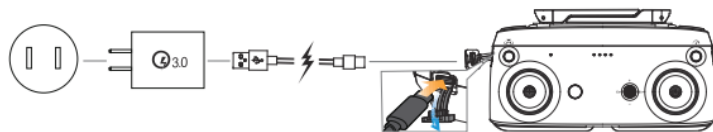

The transmitter features a standard Type-C interface. For charging, use a USB charger that supports the QC3.0 protocol, similar to chargers for smartphones, cameras, and other digital devices.

The battery lights blink green to signal the commencement of charging and turn off once the battery is fully charged. The fastest charging time is 220 minutes.

2.3 Pre-Flight Preparations >>

Preparing the Drone

- 1 Insert the battery and TF card (capacity ≤ 128G; According to the selected Storage Code Rate in the app, please choose the corresponding TF card format: 50Mbps (C10/U1/V10 or above); 100Mbps (U3/V30 or above)).
- 2 Remove the gimbal cover.
- 3 Extend the front arms and propellers.
- 4 Extend the rear arms and propellers.

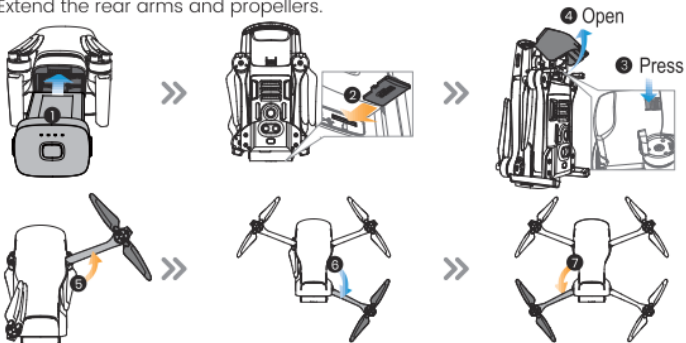

2.3 Pre-Flight Preparations >>

Preparing the Transmitter

- 1 Unfold the antennas and the handles.
- 2 Remove the joysticks from the storage slots and mount them on the transmitter.
- 3 Extend the mobile device holder and insert your mobile device with its charging port facing right. Based on your mobile device, select the corresponding transmitter adapter cable (Lightning or Type-C) included in the package. Connect one end of the cable to your mobile device and the other end to the Type-C port on the right side of the transmitter.

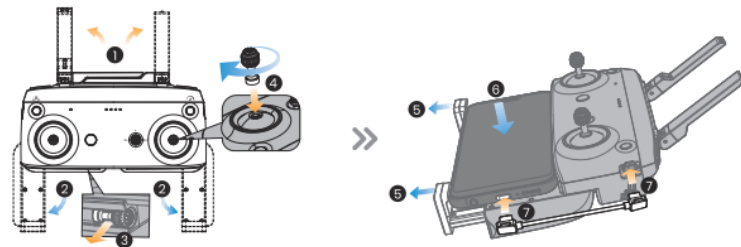

2.3 Pre-Flight Preparations >>

Antenna Angle

For optimal signal strength during drone flight, ensure to adjust the transmitter's antennas promptly so that it always points towards the drone, as illustrated below.

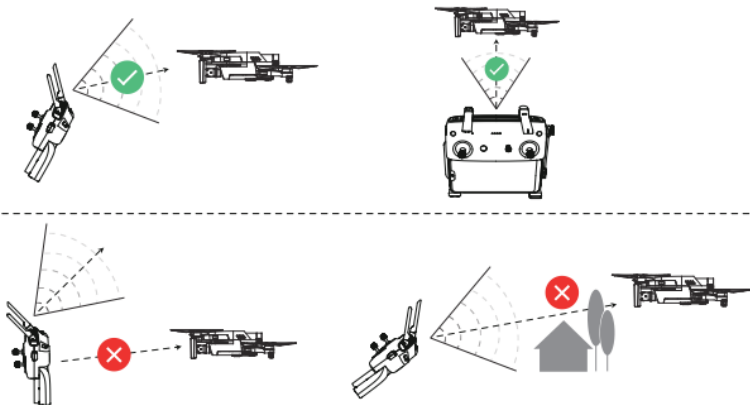

2.3 Pre-Flight Preparations >>





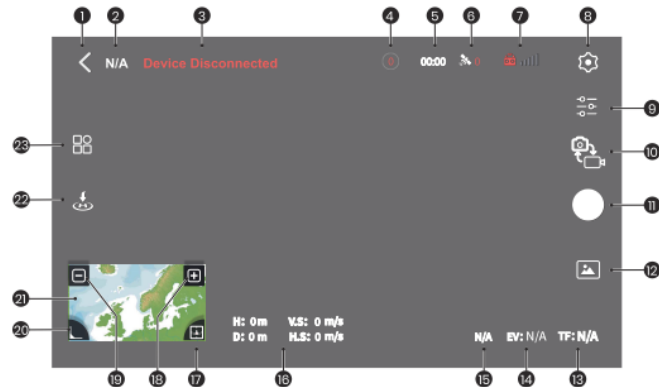











HS Sirius APP: the Interface

On this screen, you can view live high-definition videos and photos taken by the drone's camera, and adjust settings for the drone and the transmitter in real time.



2.3 Pre-Flight Preparations >>

HS Sirius APP: the Interface

- 1 Return  : Return to previous screen.
- 2 Speed Mode **N/A** : Displays the current speed setting.
- 3 Info bar **Device Disconnected** : Shows the drone's flight status and any warning alerts.
- 4 Drone Battery Level  : Shows the current battery level of the drone.
- 5 Remaining Flight Time 00:00 : Indicates how much flight time is left.
- 6 GNSS Status  0 : Indicates the current strength of the GNSS signal.
- 7 Transmitter Signal Strength  : Displays the signal strength between the transmitter and the drone.
- 8 Settings  : Access and modify safety and control settings.
- 9 Camera Settings  : Adjust settings for display, photos, videos, etc.
- 10 Photo/Video  : Toggle between photo and video modes.
- 11 Shutter/Record Button  : Press to take photos or start/stop video recording.
- 12 Album  : View photos and videos in the album.
- 13 Drone TF Card Capacity **TF: N/A** : Shows available space on the TF card.
- 14 EV **EV:N/A** : Displays the current Exposure Value.
- 15 Real-Time Screen Clarity **N/A** : Shows the quality of the current live feed.
- 16 Drone Flight Parameters:
 H: Height from the Home Point.
 D: Horizontal distance from the Home Point.
 V.S: Vertical speed of the drone.
 H.S: Horizontal speed of the drone.
- 17 Attitude Indicator and Compass  : View the drone's current orientation and direction.
- 18 Zoom In  : Slightly zoom in.
- 19 Zoom Out  : Slightly zoom out.
- 20 Collapse  : Minimize the map view.
- 21 Map  : Access the map feature.
- 22 Auto Takeoff/Landing/RTH  :
 Tap the icon and hold the button as prompted to start auto takeoff or landing.
 Tap to activate Smart RTH for the drone to return to the last recorded Home Point.
- 23 Intelligent Flight Functions  : Includes modes like time-lapse, follow, etc.

2.4 Flight >>

Powering on and pairing

- 💡 Before powering on the drone, ensure the gimbal cover is removed to avoid interfering with the drone's self-test.
- To prevent potential loss or damage, it is highly recommended that the pilot operates the drone in an open, outdoor area.

- 1 To turn on the transmitter, press once then press and hold its power button.
- 2 For the drone, press the power button once quickly, then hold it for two seconds until all four battery lights are on, indicating activation.
- 3 Position the drone horizontally and wait until its status light shifts from rapidly flashing yellow to slowly flashing green, and the system status light on the transmitter changes from red to green, signifying a successful pairing.



💡 Re-binding the drone and the transmitter

- The drone and the transmitter are bound before leaving the factory. Under normal circumstances, there is no need to bind again. The drone and the transmitter will automatically connect after powering on;
- If you have replaced your drone or transmitter, or if automatic pairing is unsuccessful, you will need to rebind them in the app.

The Operation is as follows

- 1 Turn on the transmitter and the drone.
- 2 Connect the mobile device to the transmitter → Run the HS Sirius app → Click "Profile" on the main interface of the App → Click the "Settings" → Click the "Connecting to New Drone"
- 3 Press and hold the drone battery button until all battery lights start flashing
- 4 Click 'Ready to connect' and the transmitter will automatically bind with the drone. Once the app interface indicates that the binding is successful, it confirms that the process has been completed successfully.

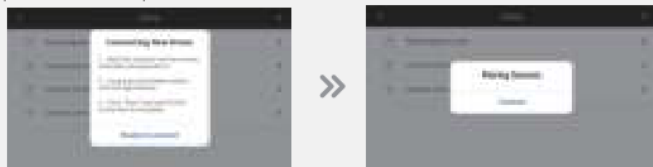

2.4 Flight >>

Entering the Flight Interface

💡 When running the app for the first time, you need to register and log in to your account as prompted, and then activate the drone.

Once the mobile device is connected to the transmitter, the mobile device needs to trust the transmitter, and the HS Sirius App will automatically launch after the transmitter is powered on, if not, please open this app manually. Once you access the app, register and log in, then tap **Go Fly**, then activate the drone, then access the flight interface.

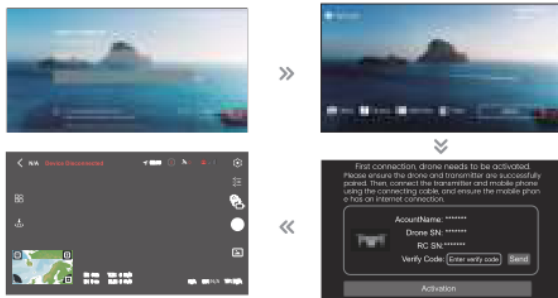

2.4 Flight >>

The GPS Satellite Positioning Signals

Checking the number of GPS signals: If the GPS count is red and less than 14, it indicates an unhealthy GPS navigation status, and the drone can only fly in AltHold mode, all GPS-related functions will be unavailable in this mode; if the GPS count is white and more than 14, it signifies a normal GPS navigation status, and the drone is clear to take off. The higher the displayed GPS count, the more accurate the positioning.

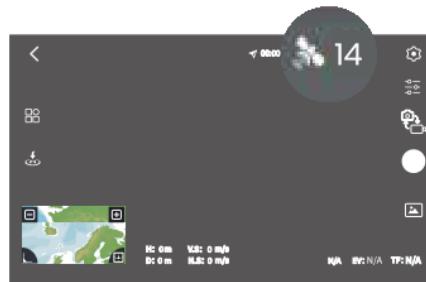

2.4 Flight >>

Calibrating the Drone Compass

Accessing Compass Calibration

Accessed from the app's flight screen, "⚙ Settings" → "🛡 Safety" → "Calibration" → "Compass Calibration", start calibrating the compass, then the drone status light turns blue.

How to calibrate the compass:

- 1 Position the drone with its head pointing vertically upward and rotate it 720° along the vertical axis. The drone's status light will begin to flash red and blue.
- 2 Next, hold the drone flat and rotate it 720° along the horizontal axis. The status light will then turn green. Finally, place the drone on a level surface to rest.

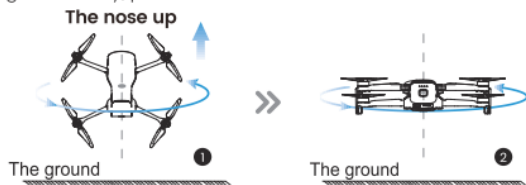

* If the calibration is unsuccessful, please repeat the steps above.





- If the HS Sirius App on your mobile device shows that the drone's magnetic compass is experiencing significant interference, or if the drone circles while hovering, or deviates from its intended straight-line path, land it promptly to calibrate the compass. Ensure that the motor is locked before doing so.
- To ensure a stable flight, we recommend that pilots perform a compass calibration before each flight.
- DO NOT calibrate the compass in locations where magnetic interference may occur, such as close to magnetite deposits or large metallic structures such as parking structures, steel reinforced basements, bridges, cars, or scaffolding.
- DO NOT carry objects that contain ferromagnetic materials near the drone during calibration.
- Please perform calibration in an open place outdoors and away from strong electromagnetic field interference.
- It is recommended that the drone be 3ft above the ground during compass calibration.

2.4 Flight >>

Unlock the Motors

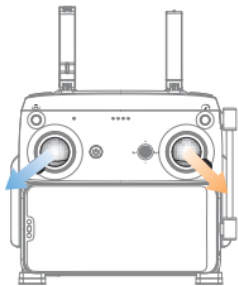
After the transmitter is successfully connected to the drone, push the left and right joysticks simultaneously to the lower, outer corners and hold them there until the motor rotates. After the motors start spinning, you can let go of the joysticks.



 Lock the Motors: Move the throttle joystick down and hold it there for 2 seconds. The motors will then stop.

2.4 Flight >>



Take-Off

 Ensure the transmitter, drone battery, and mobile device are fully charged. Confirm that the drone has acquired the satellite positioning signal, indicated by a white GPS status icon in the app (i.e., the satellite count is over 14).

Manual Takeoff

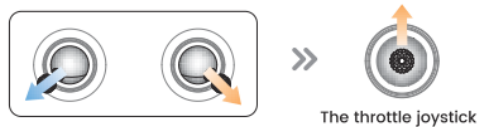
Perform the following move to start the motors, then slowly push the throttle joystick upward to take off.

**Automatic Take-off**

When the take-off condition is reached (the info bar in the upper left corner of the App displays "Be Ready"), tap the take-off icon "", tap the take-off icon "", the drone will automatically take off and rise to 6.6ft height to hover.

2.4 Flight >>

Landing

Manual Landing

Slowly pull down the throttle joystick until the drone lands on the ground. After the drone touches the ground, pull the throttle joystick to the lowest position and hold it there for 2 seconds. The motors will stop.



The throttle joystick

Automatic Landing

Tap the "📶" icon in the flight interface, then keep pressing on the "📶" icon. The drone will land automatically.

2.5 Flight Functions >>

Speed Switch

The drone has three speed modes: Stable, Normal, and Sport. To switch between these modes, simply press the speed switch button on the transmitter once or switch in the flight screen of the app "⚙️ Settings" → "🛡️ Safety" → "Speed Mode".

Stable Mode: Maximum horizontal flight speed of 5m/s; maximum ascent speed of 2m/s; maximum descent speed of 1.5m/s.

Normal Mode: Maximum horizontal flight speed of 10m/s; maximum ascent speed of 3m/s; maximum descent speed of 2.5m/s.

Sport Mode: Maximum horizontal flight speed of 14m/s; maximum ascent speed of 4m/s; maximum descent speed of 3.5m/s.

The drone defaults to Stable Mode when powered on, which is recommended for filming purposes.

💡 In Sport Mode, the drone moves quickly. To ensure flight safety, maintain at least 30 meters of braking distance.

2.5 Flight Functions >>

Return to Home (RTH)

When entering RTH mode, the drone will automatically return to the Home Point and land.

The RTH (Return to Home) can be triggered in three ways:

1 By the user:

RTH can be initiated either by tapping "📶" in app or by pressing and holding the "🏠" RTH button on the transmitter until it beeps.

2 When drone battery hits low:

The drone will automatically calculate whether it has sufficient power to return home, based on its current flight distance and altitude, and the drone will automatically start returning home in advance.

If the current battery level only supports the drone long enough to descend from its current altitude, the drone will automatically land. This auto-landing cannot be canceled, but the transmitter can still control the drone's movement during landing. During auto-landing, it's advisable to move the drone horizontally to find a suitable landing spot as soon as possible. If the user keeps pushing the throttle joystick upward until the power is depleted, the drone will fall.

3 When transmitter loses signal:

In case of transmitter signal loss, the drone will perform one of the following actions, depending on the settings in the app ("Settings" → "Safety" → "Signal Lost"): return to the Home Point, land directly, or hover in place. If the action is set to RTH, and a Home Point was previously recorded with the compass functioning normally, the RTH feature will automatically activate after the loss of the transmitter signal.



- The adjustable range for the return altitude is 98ft-394ft, please set reasonably according to the actual flight environment to avoid hitting obstacles on the way home).
- During the RTH mode process, press the RTH mode button once can cancel the RTH mode flight.
- If the GPS signal is abnormal or the GPS does not work, it is impossible to enter the RTH mode. Please manually land the drone.
- The aircraft may not be able to return to a Home Point when the wind speed is too high. Fly with caution.
- Pay extra attention to small or fine objects (such as tree branches or power lines) or transparent objects (such as water or glass) during RTH. Exit RTH and control the drone manually in an emergency.

2.5 Flight Functions >>

Return to Home (RTH)

Horizontal distance between drone and Home Point > 66ft

- a. When the drone flight height is higher than the set RTH height, the drone will maintain the current height and fly back horizontally to the top of the HOME point, then landing vertically.
- b. When the drone flight height is lower than the set RTH height, the drone will climb vertically to the set RTH height and fly back horizontally to the top of the HOME point, and then landing vertically.

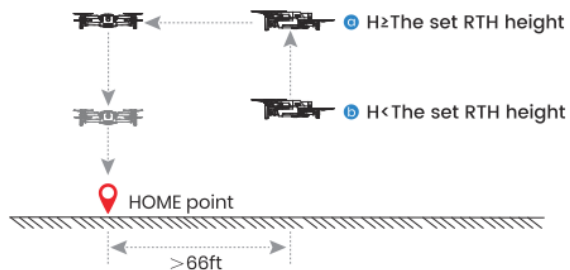
**The horizontal distance between drone and Home point $\leq 66\text{ft}$**

- The drone will maintain the current height and fly back horizontally to the top of the HOME point, then landing vertically.

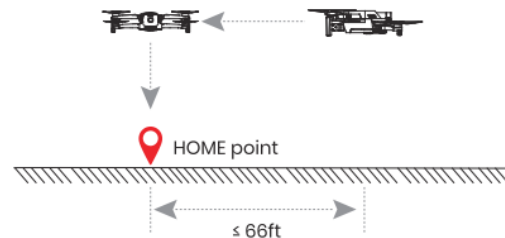

2.5 Flight Functions >>

Gimbal Control

The three-axis gimbal provides a stable platform for the camera, so that the camera can also take a stable picture while the drone is flying at high speed. You can control the pitch angle (PIT) of the gimbal through the Gimbal Dial of the transmitter.

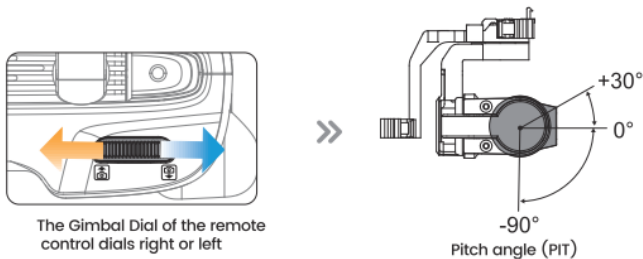

- 1 In Sport Mode, the angle adjustment range is $+30^{\circ}$ to -70° .
- 2 When the drone is flying forward, it is recommended that the gimbal angle be set below 0° to avoid screen blocking.

2.5 Flight Functions >>

Adjusting the Camera

Method 1

Quickly adjust the camera EV via the secondary joystick of the transmitter

If the image is too bright, quickly reduce the exposure value by pushing the secondary joystick to the left, darkening the image. Conversely, if the image is dark, brighten it by pushing the secondary joystick to the right to quickly increase the exposure value.

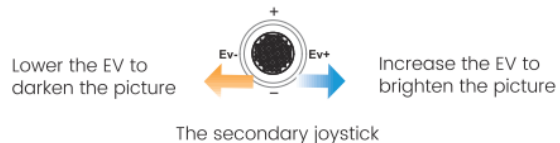

Method 2

For more detailed adjustments, access the camera settings "⚙️" in the app.

2.5 Flight Functions >>

The FN Button

You can use the app in "Settings" → "Control" → "Button customization" to customize the function including recenter gimbal and cruise control.



Recenter Gimbal: Press the FN button, the gimbal angle automatically turns to -90° . Press again, the gimbal angle automatically turns to 0° .

Cruise Control: The drone automatically flies in a straight line, at a constant speed, at the speed it was traveling at before entering cruise control mode. Push the throttle rocker to exit.

2.5 Flight Functions >>

Take Photos and Record Video

 To take photos or record videos, the drone must have a TF card inserted.

Operate in the mobile device APP interface:

- 1 Click the icon "📷" to switch between photo and video recording.
- 2 Taking photos: Click the icon "○" to take a photo.
- 3 Recording videos: Click the icon "●" to start recording. After recording, click the icon "●" again to stop recording.

Operate by transmitter:

- 1 Take photos: Press photo button "📷" at the top right of the transmitter once, and the camera will take a picture.
- 2 Record videos: Press the record button "📹" at the top left of the transmitter, the camera will start recording, press again, the camera will stop and save the video.

2.5 Flight Functions >>

Downward Vision System



Downward Vision System and TOF Ranging System

The downward vision system and TOF time-of-flight ranging sensing system are both located at the bottom of the drone. The downward vision system consists of a camera; the TOF ranging sensing system consists of a TOF detection light pulse sensor module, which can provide a reference for the height of the drone to ground and calculate the drone position with the downward vision system.

Scope of application

The downward vision system's positioning feature is ideal for areas with no or weak GPS signal, provided there's rich surface texture and adequate lighting. Its optimal operating altitude ranges from 1.6 to 33 ft. Flying beyond this altitude may reduce the effectiveness of visual positioning, so it's important to fly cautiously in such conditions.



- 1 The maximum hovering height of the drone is 8ft when using the downward vision system in an open and flatfield without GPS.
- 2 The downward vision system may not work properly on the water surface. It is recommended that the user maintains full control of the flight.
- 3 The downward vision system is not suitable for use in scenarios where the speed of the drone is too fast. For example, the flight speed shall not exceed 16ft/s at 3.3ft above the ground, and not exceed 33ft/s at 6.6ft above the ground.
- 4 The downward vision system cannot recognize surfaces without textural features, and cannot work properly in environments with insufficient or excessive light intensity.
- 5 Do not block or interfere with the vision system in any way, and avoid using it in an environment with too much dust and mist, so as not to affect the clarity of the camera. Please do not block the TOF detection light pulse transceiver sensor in any way.
- 6 Avoid flying in rainy and foggy weather or in other scenarios with low visibility (visibility below 328ft).

The vision system does not work properly in the following scenarios:

- a Solid color surfaces (e.g. solid black, solid white, solid red, solid green).
- b Surfaces with strong reflections (e.g. ice surface).

2.5 Flight Functions >>

Downward Vision System

- c** Surface of water or transparent objects.
- d** Surfaces of moving objects (e.g. above stream of people, above shrubs or grass blown by high winds).
- e** Scenarios with dramatic and rapid changes in lighting.
- f** Surfaces that are particularly dark (less than 10lux) or particularly bright (greater than 40,000lux).
- g** Material surfaces that have a strong absorption or reflection effect on square wave pulses (e.g. mirrors).
- h** Surfaces with particularly sparse texture.
- i** surfaces of objects with a high degree of texture repetition (e.g. small checkered tiles of the same color).
- j** Tiny obstructions (e.g. tree branches, wires, etc.)

2.6 Additional Instructions >>

Replacing the propellers



- 1** Use a screwdriver to remove the propeller screws and then take off the propellers.
- 2** Replace with new propellers and tighten the screws securely. Ensure that the rotation direction (clockwise or counterclockwise) indicated by the icons on both the arm and the propeller is consistent. Incorrect propeller installation will result in the drone being unable to fly.

- !** - Make sure the propellers are secure and tight.
- If the propellers become deformed or damaged, please replace them before flying again.

Remove the Battery



After pressing and holding the textured part of the snaps on both sides of the battery, pull it toward the rear of the drone to remove the battery.

2.6 Additional Instructions >>

Drone Battery Status and Battery Light Status



- 1 The indicator lights up sequentially from left to right in a continuous cycle, indicating that the battery is being charged.
- 2 When normally displaying the power level, the battery lights have three states: all lights on, some lights steady and one blinking, and some lights off.
- 3 The battery will automatically turn off if the drone does not take off within 10 minutes after being powered on.
- 4 If the charger is disconnected during charging, the battery will automatically turn off after 5 minutes, or it can be manually turned off immediately.
- 5 If the battery remains on and unused with a charge level above 65%, it will enter standby mode. After 5 days, it will begin to automatically discharge until the charge level drops to 65%, at which point the battery will automatically turn off.

3.1 Specifications >>

Camera

Image Sensor:	1/2.3-inch CMOS, 48 million effective pixels
Lens:	FOV83°; 4.49mm
ISO Range:	100-1600
Electronic Shutter:	1/2-1/4000
Photo Resolution:	8192*4608/3840*2160
Video Resolution:	FHD: 1920*1080 (60fps) UHD: 3840*2160 (30fps)
Storage Maximum Code Rate:	50/100Mbps
Supported File System Format:	Fat32; exFat
Image Format:	JPEG; RAW (RAW format, later can be opened through firmware upgrade)
Video Format:	MP4
Support Memory Card Type:	Micro SD card, maximum support of 128G, 50Mbps (U1/U1/U10 or above); 100Mbps (U3/V30 or above);

Downward TOF and Visual Positioning System

Precise ranging range:	0.25m-5m
Visual hover range:	0.25m-10m

Transmitter

Dimensions (L x W x H):	152.5x47x82mm (Fold)
Operating Frequency:	2.4GHz
Battery:	Built-in lithium battery 3.7V 3900mAh LiPo

Drone

Diagonal Motor Distance:	241.6mm
Dimensions (L*W*H):	167.4mm*217.8mm*62mm (Unfold) 143mm*82.8mm*62mm (Fold)
Take-off Weight:	249g
Max Ascent Speed:	Default is 4m/s
Max Descent Speed:	Default is 3.5m/s
Maximum Horizontal Speed (No wind):	14m/s
Max Tilt Angle:	35°
Max Takeoff Altitude:	4500m
Max Withstand Wind Speed:	Force 5 wind
Battery Specification:	7.7V, 2250mAh, LiPo 2S, 10C
Operating Temperatures:	-10°C to + 45°C
Max Flight Time:	30min (Hovering in a windless environment, and from 100% battery level until 0%.)

Gimbal

Stability System:	3-axis (pitch, yaw, roll)
Controllable Rotation Range:	Pitch: -90° to 30°
Max. Control Speed:	Pitch: 5°/s-100°/s adjustable;
Angle Control Accuracy:	static: ± 0.01°; dynamic: ± 0.02°; stabilization: ± 0.01°

3.2 Contact Us >>

Please do not hesitate to contact us if you need further support.



usa@holystone.com (America)
eu@holystone.com (Europe)



www.holystone.com



+1 (833) 766-4733

3.3 Troubleshooting >>

Issues	Possible Causes and Suggested Solutions
Unstable flight or abnormal posture	GPS signal may be weak. Fly in open areas with a satellite count of 14 or more. Avoid flying indoors, between high buildings, or in wooded areas.
	Compass may be experiencing interference. Recalibrate the compass before attempting to fly again.
App connection with transmitter failed, no live-feed	1. Agree to all prompts after connecting phone and transmitter. 2. Ensure all necessary app permissions are enabled.
	Close app, reconnect phone and transmitter, then reopen app.
Laggy live-feed, weak transmitter signal	Point the transmitter's antenna directly at the drone, avoiding any obstacles between them for optimal signal strength. (See pages 13)
	2.4G signals are prone to interference. Choose locations with minimal signal disruption for flying.
	To improve image transmission, switch to standard image quality in the camera settings.
Flight height and distance are limited.	Ensure you have registered for an account and are logged in.
	Drone's flight height is limited to 8ft in no or weak GPS signal areas. Opt to fly in open spaces with a satellite count of 14 or more.
	Drone is currently in beginner mode. Disable beginner mode to adjust safety distances.

3.4 Compliance Information >>

FCC Notice:

This device complies with part 15 of the FCC Rules. Operation is subject to the following two conditions:

- (1) This device may not cause harmful interference, and
- (2) This device must accept any interference received, including interference that may cause undesired operation.

The Supplier's Declaration of Conformity is available at the following address:

https://www.holystone.com/Download/US/HS900_FCC_sDoC.pdf

This equipment has been tested and found to comply with the limits for a Class B digital device, pursuant to part 15 of the FCC Rules. These limits are designed to provide reasonable protection against harmful interference in a residential installation. This equipment generates, uses and can radiate radio frequency energy and, if not installed and used in accordance with the instructions, may cause harmful interference to radio communications. However, there is no guarantee that interference will not occur in a particular installation. If this equipment does cause harmful interference to radio or television reception, which can be determined by turning the equipment off and on, the user is encouraged to try to correct the interference by one or more of the following measures:

- Reorient or relocate the receiving antenna.
- Increase the separation between the equipment and receiver.
- Connect the equipment into an outlet on a circuit different from that to which the receiver is connected.
- Consult the dealer or an experienced radio/TV technician for help.

Changes or modifications not expressly approved by the party responsible for compliance could void the user's authority to operate the equipment.

3.4 Compliance Information >>

RF Exposure:

The equipment complies with FCC radiation exposure limits set forth for an uncontrolled environment. This device should be installed and operated with minimum distance 20cm between the radiator & your body.

IC Notice:

This device complies with Canada Industry licence-exempt RSS standard(s).

Operation is subject to the following two conditions:

- (1) this device may not cause interference; and
- (2) this device must accept any interference. Including interference that may cause undesired operation of the device.

CAN ICES-003 (B):

Avis d'Industrie Canada

Le présent appareil est conforme aux CNR d'industrie Canada applicables aux appareils radio exempts de licence. L'exploitation est autorisée aux deux conditions suivantes:

- (1) l'appareil ne doit pas produire de brouillage; et
- (2) l'utilisateur de l'appareil doit accepter le brouillage radioélectrique subi même si le brouillage est susceptible d'en compromettre le fonctionnement. mauvais fonctionnement de l'appareil. Cet appareil numérique de la classe B est conforme à la norme NMB-003 du Canada.

3.4 Compliance Information >>

CAN NMB-003 (B):

RF Exposure

Radiation Exposure Statement:

This equipment complies with IC radiation exposure limits set forth for an uncontrolled environment. This equipment should be installed and operated with a minimum distance of 20cm between the radiator & your body.

Déclaration d'exposition aux radiations:

Cet équipement est conforme aux limites d'exposition aux rayonnements IC établies pour un environnement non contrôlé. Cet équipement doit être installé et utilisé avec un minimum de 20 cm de distance entre la source de rayonnement et votre corps.

EU RF Power(EIRP): <14 dBm (2452MHz-2474 MHz)

Caution

1. The max operating of the EUT is 45°C, and shouldn't be lower than -10°C.
2. The device complies with RF specifications when the device used at 0mm from your body.
3. Declaration of Conformity.

We, Xiamen Huoshiquan Import & Export CO.,LTD

hereby, declare that the compliance of the essential requirements with the Directive 2014/53/EU, the RoHS Directive 2011/65/EU and Safety Directive 2009/48/EC have been fully fulfilled on our product with

3.4 Compliance Information >>

Indication below:

Product Name: Remote control four axis series

Model/Mark: HS900/HolyStone

The Statement of compliance is available at the following address:

http://www.holystone.com/Download/CE/HS900_EU_DOC.pdf

This product can be used among EU member states.

MANUFACTURER INFORMATION:

Manufactured by

Xiamen Huoshiquan Import & Export CO.,LTD.

Address: Unit 1, Room 501, Hongxiang Building, No.258 Hubin Nan Road, Siming District, Xiamen, China

+1 (833) 766-4733

MTOM Statement:

HS900 is a quadrotor drone. The MTOM of HS900 is 249g, including the propellers, the Flight Battery, TF card, which is compliant with C0 requirements.

Users must follow the instructions below to comply with the MTOM C0 requirements. Otherwise, the drone cannot be used as a C0 aircraft:

1. DO NOT add any payload to the aircraft except the items listed in the List of Items including qualified accessories section.
2. DO NOT use any non-qualified replacement parts, such as flight batteries or propellers, etc.
3. DO NOT retrofit the aircraft.

3.4 Compliance Information >>

List of Items including qualified accessories

1. HS900 Propellers (0.8g each propeller)
2. HS900 Flight Battery (approx. 83.2 g)
3. HS900 TF card (approx. 0.3 g)

List of Spare and Replacement Parts

1. HS900 Propellers (0.8g each propeller)
2. HS900 Flight Battery (approx. 83.2 g)

List of Safe Guards

Below is the list of the mechanical safeguards and operation safeguards for HS900.

1. Prevent the drone from flying in restricted airspace. Refer to the Flight Environment Requirements section for details.
2. The Return to Home (RTH) function. Refer to the GPS Return to Home section for details.
3. The Optical Flow Positioning. Refer to the Optical Flow Positioning section for details.



MADE IN CHINA(CN)