

# **H216A X4 STAR PRO**

«H216A User Manual»

Version 1.0

# 2 Different Ways to Fly, 2 Configurations

## 1. Aircraft + mobile device (phone/tablet)

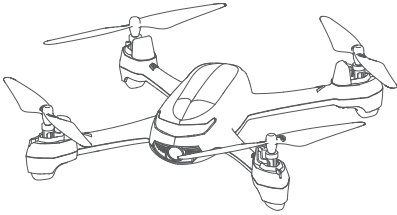

H216A



Mobile device (phone/tablet)

## 2. Aircraft + HT009 Transmitter + mobile device (phone/tablet)

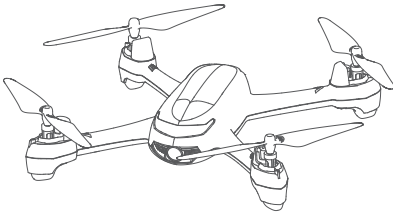

H216A

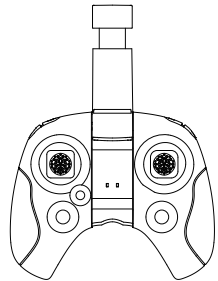

HT009

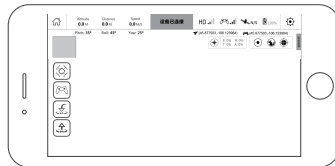

Mobile device (phone/tablet)

## Important safety information

- Operation:** Be extremely careful and responsible when using the quad. Small electronic components can be damaged due to crashes or exposure to moisture/liquid. To avoid any injuries, do not use the quad with broken or damaged components.
- Maintenance:** Do not try to open or repair the units by yourself. Please contact Hubsan or Hubsan authorized dealers for service. For more information, please visit the official website at [www.hubsan.com](http://www.hubsan.com).
- Battery:** Do not disassemble, squeeze, impact, burn, drop or trample the battery. Do not short-circuit or put the battery terminal in contact with metal.  
Do not expose the battery to temperatures above 60 ° C.  
Charge the aircraft battery prior to flight. Use a Hubsan dedicated charger for charging. Keep the battery out of the reach of children and away from any kind of moisture.
- Flight:** Please be mindful of personal safety and the safety of others while flying.
- Do not fly in bad weather conditions.
  - Do not attempt to catch the aircraft while it is in flight.
  - This product is intended for experienced pilots over the age of 14.
  - After every flight, completely disarm the aircraft motors and disconnect the aircraft from power. Then, you may power off the remote control.

Read the Disclaimer and Safety Guidelines first before use.

## Symbol explanation:

 Prohibited operation

 Instruction

 Important Notice

 Explanation/reference

**USAGE ADVICE** (Hubsan has created the following operational and safety materials)

 《Quick Start Guide》

 《Disclaimer and Safety Guidelines》

## Safety Advisory Notice for Lithium-Polymer (LIPO) Batteries

LiPo batteries are different from conventional batteries in that their chemical contents are encased in a relatively lightweight foil packaging. This has the advantage of significantly reducing their weight but it does make them more susceptible to damage if roughly or inappropriately handled. As with all batteries, there is a risk of fire or explosion if safety practices are ignored:

- If you do not plan to fly the quad for a long time, store the battery ~50% charged to maintain battery performance and life.
  - Please use Hubsan chargers for battery charging.
  - Discharge the battery at 5C current or below. To avoid discharge related battery damage, do not prolong the discharge time.
  - Do not charge on carpet to avoid fire.
  - Batteries need to be recharged if unused for over 3 months.
- ⊗
1. Do not disassemble or reassemble the battery.
  2. Do not short-circuit the battery.
  3. Do not use or charge near sources of heat.
  4. Do not put the battery in contact with water or any kind of liquid.
  5. Do not charge batteries under sunlight or near fire.
  6. Do not puncture or subject the battery to force of any kind.
  7. Do not throw or manhandle the battery.
  8. Never charge a battery that has been damaged, become deformed or swelled.
  9. Do not solder on or near the battery.
  10. Do not overcharge or over discharge the battery.
  11. Do not reverse charge or reverse the battery polarities.
  12. Do not connect the battery to a car charger/cigarette lighter or any kind of unconventional power source.
  13. This battery is prohibited for non-designated devices.
  14. Do not touch any kind of liquid waste or byproduct from batteries. If skin or clothes come in contact with these substances, please flush with water!
  15. Do not mix other types of batteries with lithium batteries.
  16. Do not exceed the specified charging time.
  17. Do not place the battery in a microwave or in areas of high pressure.
  18. Do not expose the battery to the sun.
  19. Do not use in environments with high static electricity (64V and above).
  20. Do not use or charge in temperatures below 0 °C and above 45 °C.
  21. If a newly purchased battery is used, leaking, possesses a bad smell or other abnormalities, return immediately to the vendor.
  22. Keep away from the reach of children.
  23. Use a dedicated battery charger and follow all charging requirements.
  24. Minors who use the battery and its dedicated unit must be supervised by an adult at all times.

# Table of Contents

Important safety information -----	2	4.5 Horizontal calibration -----	14
Symbol Explanation-----	2	4.6 Headless mode -----	14
Usage Advice -----	2	4.7 Waypoints -----	15
<b>1. The H122D Aircraft</b> -----	<b>5</b>	4.8 Follow me -----	15
1.1 Aircraft component breakdown ---	5	4.9 Orbit mode-----	15
1.2 The aircraft battery -----	5	<b>5. Flying with the remote</b>	
1.3 Installing and Removing -----	6	<b>control/transmitter</b> -----	<b>16</b>
1.4 Aircraft LED indications -----	8	5.1 Flight environment	
<b>2. The HT009 Remote</b>		requirements -----	16
<b>Control/Transmitter</b> -----	<b>8</b>	5.2 Pre-Flight Checklist -----	17
2.1 The HT009 Remote		5.3 Binding the aircraft and	
Control/Transmitter -----	8	transmitter -----	17
2.2 Remote control components ---	9	5.4 Compass calibration -----	18
and functions		5.5 Takeoff/Landing -----	19
2.3 Battery installation -----	10	5.6 Basic flight operation -----	21
<b>3. X-Hubsan APP</b> -----	<b>10</b>	<b>Failsafe modes</b> -----	<b>22</b>
3.1 APP Overview -----	10	<b>Frequently Asked Questions</b> -----	<b>23</b>
3.2 Downloading the APP -----	10	<b>H216A Accessories</b> -----	<b>24</b>
3.3 APP Interface Guide -----	11		
<b>4. Flying with the APP</b> -----	<b>11</b>		
4.1 Pairing the aircraft and			
mobile device -----	11		
4.2 Compass calibration -----	12		
4.3 Takeoff/Landing -----	12		
4.4 Joystick mode settings -----	14		

# 1 The H216A Aircraft

## 1.1 Aircraft component breakdown

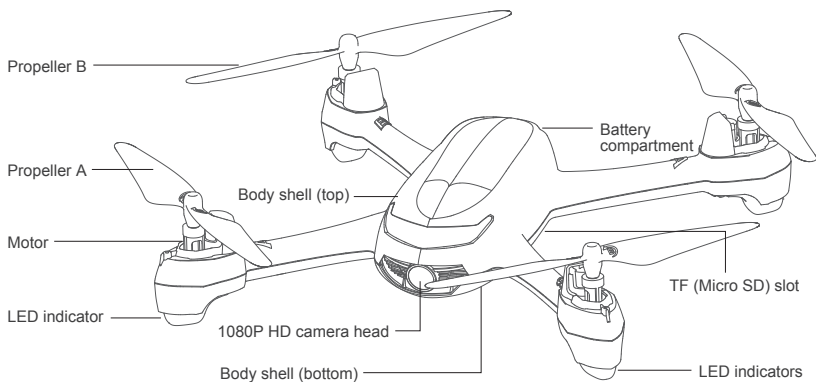

## 1.2 The aircraft battery

The H216A aircraft is paired with a rechargeable 7.6v, 750mAh Li-Po. Be sure to use the provided Hubsan dedicated charger for charging. Fully charge the battery before flight.

1. Installation: Push the battery into its compartment with its lines facing away from the unit (shown in the below figure). Connect it to the drone's power line (correctly match the polarities) and coil the power line into the compartment.

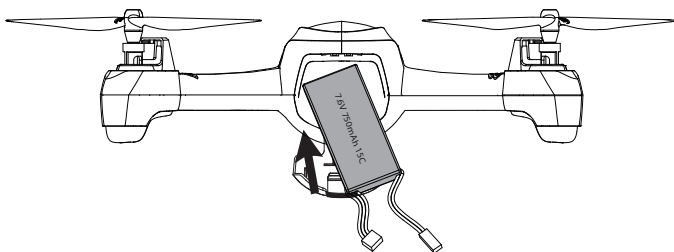

2. Connect the battery to the USB charging cable. Then, connect the USB charging cable to a computer or wall adapter. When charging, the charger will flash red; after charging is finished, the charger will stay solidly lit. Please remove the battery from the charger promptly when charging has finished. Full charging time is around 150 minutes.

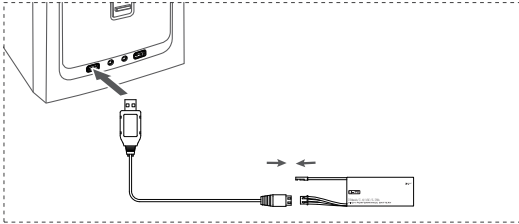

- Make sure the battery is fully charged before each flight.
- Please do not leave unattended while charging.
- When charging is complete, disconnect the charger and battery from power immediately.

### 1.3 Installing and Removing the propellers

The X4 aircraft uses 5.3-inch propellers. Each is marked with either an A or a B. Please replace damaged propellers. Before installing the propellers for the first time, please check whether the propeller and motor arm read "A" or "B". The two letters should match.

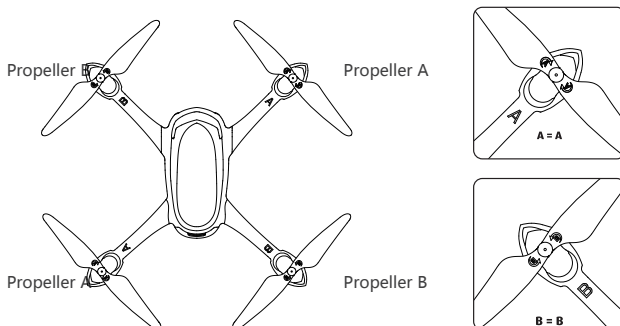

**Notice:**

Mind the differing colors of the A and B propeller screws!

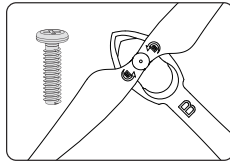

Propeller B

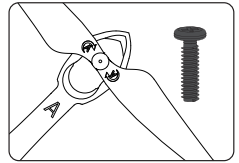

Propeller A

Installation: Before installing propellers for the first time, please check that each Propeller A is matched with motor A and each Propeller B is matched with motor B. Align the "I" with the flat side of the "D" shaped motor shaft. Then use the provided screws and screwdriver to secure each propeller. Propeller A's are paired with black propeller screws and are tightened counterclockwise. Propeller B's are paired with silver propeller screws and are tightened clockwise. (as shown below)

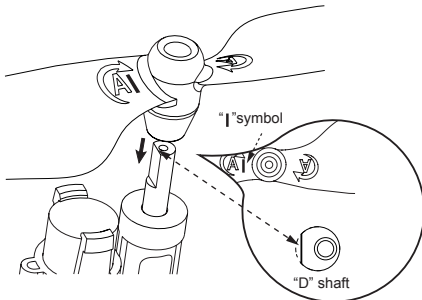
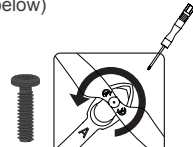
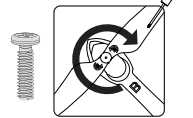

Figure 1



Counterclockwise



Clockwise

If propellers need changing, please use a screwdriver to loosen the screw clockwise on Propeller A. To remove the screw on Propeller B, loosen its screw counterclockwise.

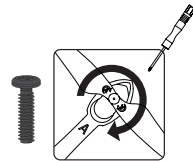
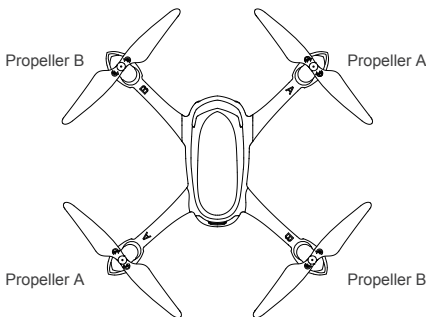

Clockwise

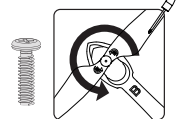

Counterclockwise



- Make sure that the propellers are installed in the correct positions (A to A, B to B). Otherwise, the aircraft will not be able to fly normally.
- Since the propeller blades are thin and somewhat sharp, it is recommended that users wear gloves during installation to prevent accidental injury.

## 1.4 Aircraft LED indications

The H216A has 4 LEDs; the fore/frontal LEDs are blue and the rear LEDs are red. The LED status indications are defined as follows:

Function		LED status indication
Power on and start up		All 4 LEDs flash simultaneously
Compass Calibration	Calibrate Compass 1	All 4 LEDs flash clockwise
	Calibrate Compass 2	LEDs flash in vertical pairs, alternately
Horizontal Calibration		All 4 LEDs flash simultaneously
Flight mode		All 4 LEDs are solidly lit
Headless mode		Fore LEDs slowly flash blue and rear LEDs are solid red.
Return to Home		Fore LEDs are solid blue and rear LEDs slowly flash red.
Low power		Fore/frontal blue LEDs stay solidly lit and the rear red LEDs flash rapidly
Flight control connection status		When the aircraft is not connected to a transmitter or has been disconnected from a transmitter, the fore LEDs will flash blue. Upon connection with a transmitter, the fore LEDs will turn solid.

## 2 The HT009 Remote Control/Transmitter

The HT009 is a Bluetooth transmitter fully outfitted for use with the H216A aircraft and its various functions. Experience real-time video transmission through the X-Hubsan app on a mobile device equipped with a high definition screen.

### 2.1 The HT009 Remote Control/Transmitter

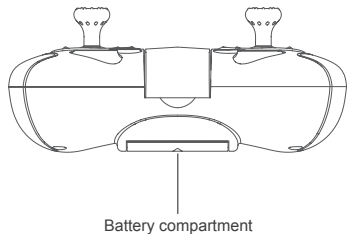
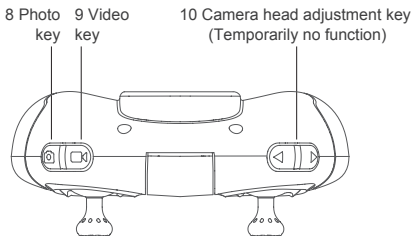

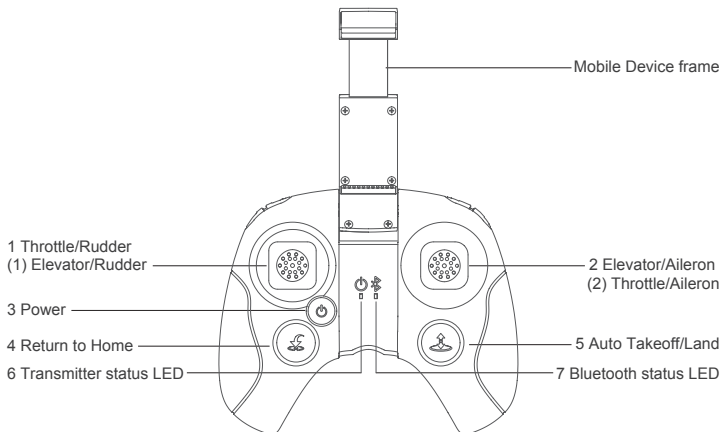

## 2.2 HT009 key functions

No.	Key/button/Switch	Function
1	Throttle/Rudder stick	Push the stick forward or backward and the quadcopter will ascend or descend (respectively). Push the stick left or right and the quadcopter will rotate counterclockwise or clockwise (respectively).
2	Elevator/Aileron stick	Push the stick forward or backward and the quadcopter will fly forwards or backwards (respectively). Push the stick left or right and the quadcopter will fly left or right (respectively).
(1)	Throttle/Aileron stick	Push the stick forward or backward and the quadcopter will ascend or descend (respectively). Push the stick left or right and the quadcopter will fly left or right (respectively).
(2)	Elevator/Rudder stick	Push the stick forward or backward and the quadcopter will fly forwards or backwards (respectively). Push the stick left or right and the quadcopter will rotate counterclockwise or clockwise (respectively).
3	Power	Push the stick forward or backward and the quadcopter will fly forwards or backwards (respectively). Push the stick left or right and the quadcopter will rotate counterclockwise or clockwise (respectively).
4	Return to Home	Long press for 1.5 seconds and the quadcopter will perform a Return to Home. To terminate Return to Home, short press for 0.5 seconds.
5	Auto Takeoff/Auto Land	Long press for 1.5 seconds and the quadcopter will perform an Auto Takeoff or Auto Land (if the unit is airborne).
6	Transmitter status LED	When the transmitter is powered on, the LED should be solidly lit. If the transmitter is low on power, the LED will flash rapidly.
7	Bluetooth status LED	When the transmitter is powered on, the LED should be solidly lit. If the transmitter is low on power, the LED will flash rapidly.
8	Photo	Short press the key to take a photo.
9	Video	Short press once to start the recording; short press again during the recording to stop the recording.
10	Camera head adjustment key	Temporarily no function.

## 2.3 Battery installation

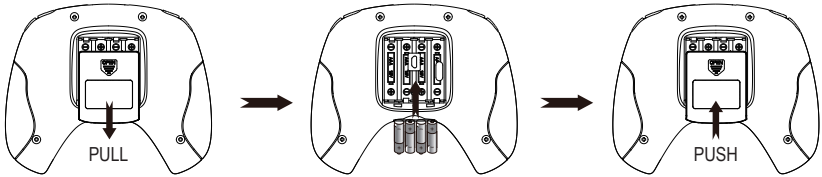

Remove the compartment screw.  
Slide open the compartment hatch.

Insert 4 AAA batteries into the battery  
compartment. Take note to make sure  
you have correctly matched the polarities.

Slide the compartment hatch  
to close it; screw it shut.

- Do not mix new and old batteries
- Do not cross-use different types of batteries at the same time

## 3 X-Hubsan APP

### 3.1 APP Overview

X-Hubsan is a flight control APP designed for HUBSAN WIFI enabled aircraft. Users can control flight, camera, video and flight parameters with the APP. It is recommended to use a large screened smartphones or tablets for the optimal visual experience.

### 3.2 Downloading the APP

Before flying, users must download the X-Hubsan APP.

Download the APP for free by scanning the below code or by downloading it via the App Store (iOS) and Google Play (Android).



### 3.3 APP Interface Guide

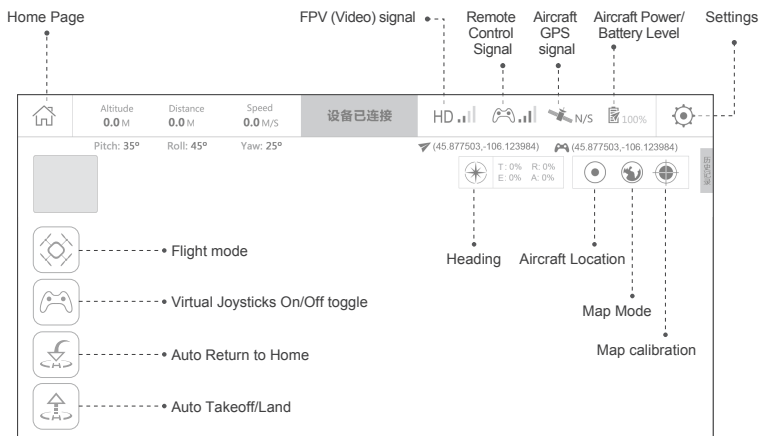

## 4 Flying with the APP

### 4.1 Pairing the aircraft and mobile device

Connect the aircraft to its battery and power it on. Go to your mobile device's WIFI settings and pair the device with the aircraft. Then, run the X-Hubsan APP.

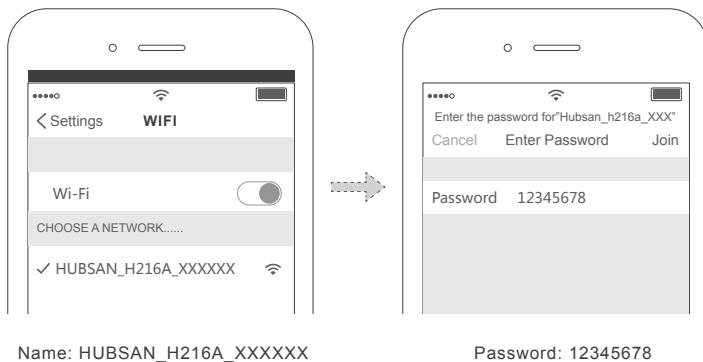

## 4.2 Compass calibration

The compass must be calibrated every time the aircraft is powered on. The compass is susceptible to interference by other electronic equipment, magnetic interference and metal, which can lead to erratic behavior and loss of control. Regular calibration helps keep the compass and its readings accurate.

(1) Enter the X-Hubsan flight interface. Follow the APP's on-screen instructions.

(2) Complete Calibrate Compass 1 and 2. Once both steps are completed, the calibration window will disappear.

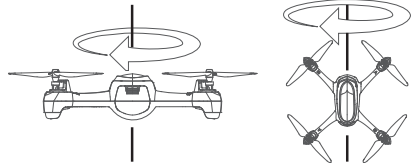

## 4.3 Takeoff/Landing

### Takeoff

a) Simultaneously pull the virtual joysticks diagonally down-out to arm the motors (as shown in the below figure). Slowly push the throttle stick up; the aircraft will ascend and takeoff.

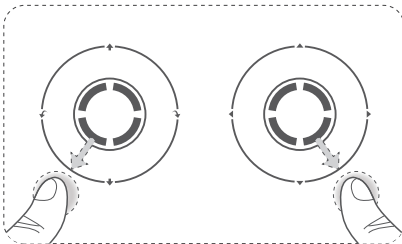

Arming the motors

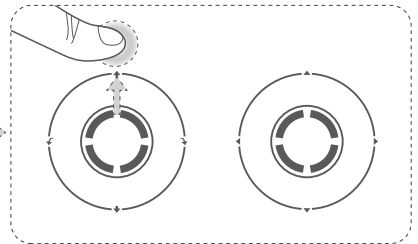

Pushing the throttle for ascent (Mode 2/American hand)

b) Auto Takeoff: First, confirm that take-off conditions are safe and clear. Tap the Auto Takeoff icon; the aircraft will automatically takeoff and hover at a height of ~2 meters from the ground. Note that the Auto Takeoff key will turn into an Auto Land key after the aircraft begins to fly.

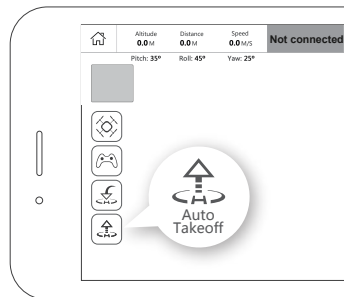

## Landing

a) Manual landing (with the virtual joysticks): Slowly push down the throttle stick until the copter has completed its descent to the ground. Disarm the motors by simultaneously pulling both sticks diagonally down-out. When the motors have completely stopped, release the joysticks.

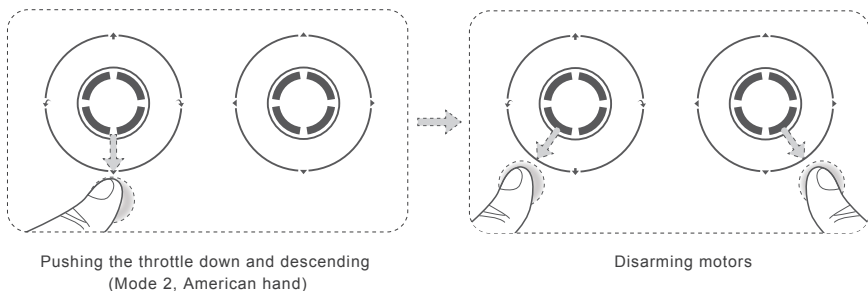

b) Auto Land: Tap the Auto Land icon and the aircraft will slowly descend to the ground. (Figure 1)

Return to Home: Tap the Return to Home icon and select whether you would like the aircraft to return to its takeoff point, or to the mobile device's current position. (Figure 2)

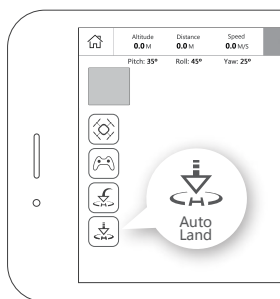

Figure 1

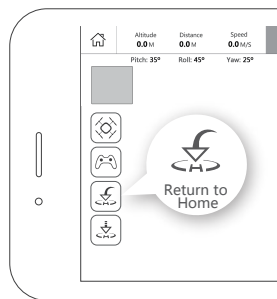

Figure 2



Before taking off, make sure that there are no obstructions in the flight route or environment. Be sure to choose a flat, open area when landing.

To ensure safe flight, do not use your mobile device for other purposes or pair your unit with another mobile device during operation. If you wish to use another device to fly the aircraft, please power the unit off before re-initiating a new pairing.

## 4.4 Transmitter mode settings

Enter the X-Hubsan home interface and tap the Settings cog, followed by the Controller tab. You may then adjust joystick settings.

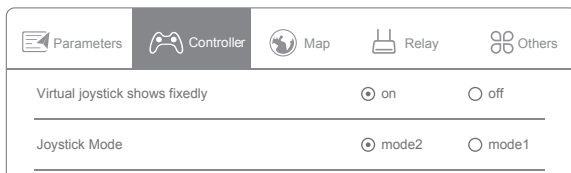

## 4.5 Horizontal Calibration

If during takeoff or flight the aircraft drifts, lifts off unevenly, perform a horizontal calibration. Tap the Settings cog, followed by "Other". Select "Horizontal Calibration" and allow the aircraft to calibrate itself. Calibration is complete when all 4 LED indicators stop flashing. It is recommended that users wait for 15-20 seconds after the calibration is completed before flying again.

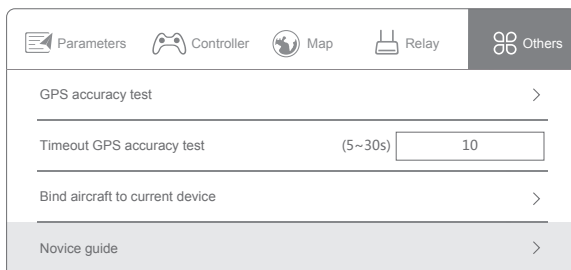

## 4.6 Headless mode

Tap the compass icon to activate Headless mode. The aircraft will set the direction its head is pointing at the time of activation as the default "forward" direction in Headless mode.

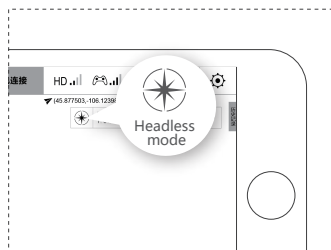

## 4.7 Waypoints

While motors are completely disarmed, tap the Flight mode icon and select the Waypoint mode icon. You can custom set each Waypoint altitude, travel speed and other parameters before uploading your Waypoint mission. After takeoff, the aircraft will fly its specified route.

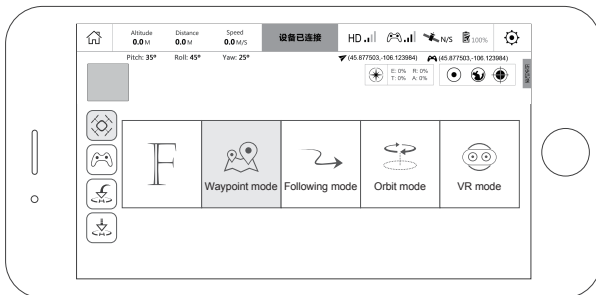

## 4.8 Follow Me

Tap Flight mode icon and select Follow Me. The aircraft will now follow the mobile device.

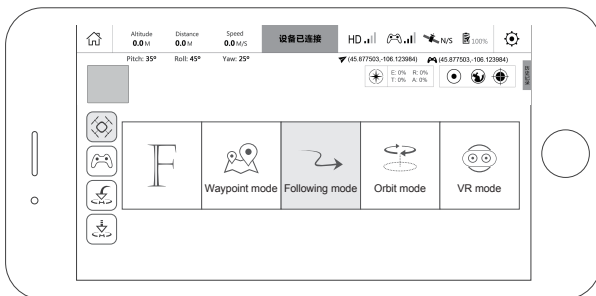

## 4.9 Orbit mode

Tap the Flight mode icon and select Orbit/Circle fly. The aircraft will fly in a circle around the mobile device. Orbit is only usable when the aircraft is at least 3 meters away from the mobile device.



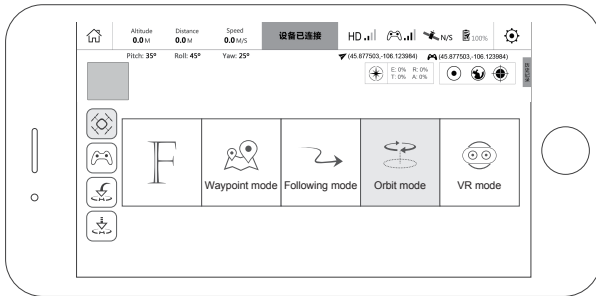

Please begin flight only when you have 6 or more GPS satellites. Waypoint/Return to Home/Orbiting/Follow Me modes are then accessible. Note: GPS cannot be accessed indoors.

## 5 Flying with the remote control/transmitter

It is recommended that users implement some kind of flight training (i.e using a simulator for flight practice, seeking professional guidance, etc.) before flying the aircraft. Please select an appropriate environment for flight.

### 5.1 Flight environment requirements

- (1) Select an open environment devoid of high rise buildings and tall obstructions (such as trees and poles). Near buildings and obstacles, flight control signals and GPS signals can be severely weakened; GPS functions such as GPS mode and Return to Home may not function properly.
- (2) Do not fly in bad weather conditions (such as in wind, rain or fog).
- (3) Fly the drone in ambient temperatures of 0-40 °C.
- (4) When flying, please stay away from obstructions, crowds, high voltage lines, trees, water, etc.
- (5) To avoid remote control signals interference, do not fly in electromagnetic environments (such as venues with radio stations, power plants and towers).

- (6) The aircraft cannot be used in or near the Arctic circle or Antarctica.
- (7) Do not fly in no fly zones.
- (8) Do not operate the aircraft near high pressure lines, airports or areas with severe magnetic interference.

## 5.2 Pre-Flight checklist

- (1) Make sure the aircraft battery and mobile device are charged and have adequate power.
- (2) Confirm that propellers and screws are properly installed.
- (3) If you are taking pictures, insert the Micro-SD card required for taking pictures and videos before power on.
- (4) Verify that the motors arm and spin smoothly.
- (5) Ensure the camera lens is clean.

## 5.3 Pairing the aircraft and transmitter

Connect the aircraft to its battery and power it on. Go to your mobile device's WIFI settings and pair the device with the aircraft. Then, run the X-Hubsan APP.

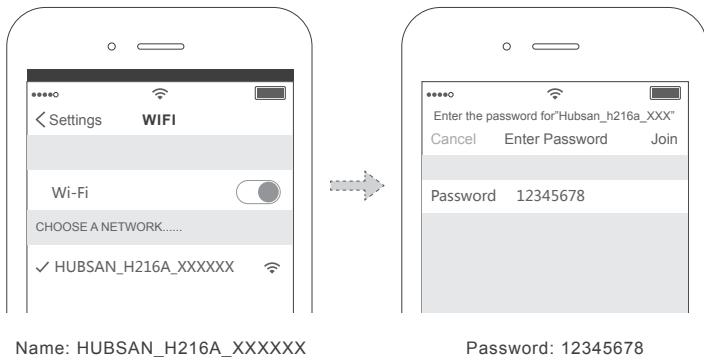

Power the transmitter on; pair the mobile device and transmitter on the Bluetooth menu.

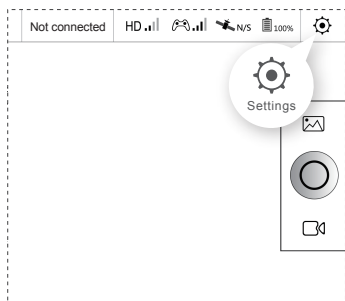

1. Enter the main app interface and tap the Settings cog on the upper right-hand corner.

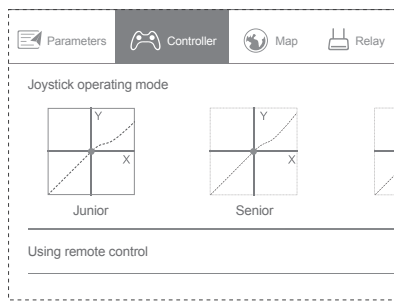

2. Tap "Controller" and then "Using remote control".

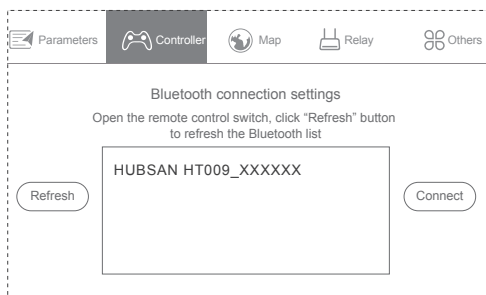

4. The interface will then show the "Bluetooth connection settings" menu. Select the HUBSAN HT009\_XXXXXX and confirm to connect.

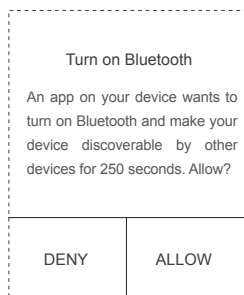

3. The device will request permission to use Bluetooth. Tap "Allow" to continue.

When the Bluetooth connection is successful, the interface will say, "Bluetooth connection successful". The HT009 transmitter will beep; the Bluetooth connection LED will turn solid.

## 5.4 Compass calibration

The compass must be calibrated every time the aircraft is powered on. The compass is susceptible to interference by other electronic equipment, magnetic interference and metal, which can lead to erratic behavior and loss of control. Regular calibration helps keep the compass and its readings accurate.

- (1) Enter the X-Hubsan flight interface. Follow the APP's on-screen instructions.
- (2) Complete Calibrate Compass 1 and 2. Once both steps are completed, the calibration window will disappear.

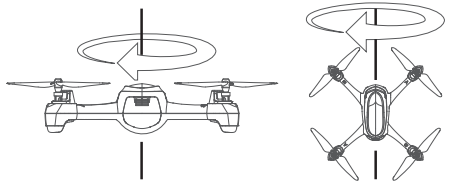

## 5.5 Takeoff/Landing

### Takeoff

Manual takeoff: To start/arm the motors, please be sure that the joystick setting is activated. Simultaneously pull both joysticks diagonally down-out as shown in the right hand figure. Slowly push the throttle stick up; the aircraft will ascend and takeoff.

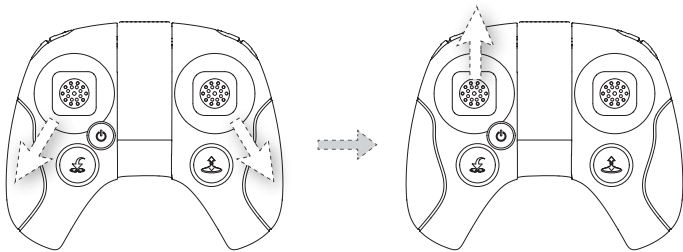

Auto Takeoff: Press the Auto Takeoff button (right hand figure). The aircraft will take off and hover at a height of around 2 meters. Note that the Auto Takeoff key will turn into an Auto Land key after the aircraft begins to fly.

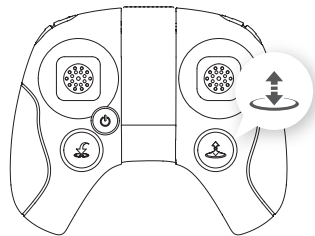

### Landing

Manual landing: Slowly push down the throttle stick until the copter has completed its descent to the ground. Disarm the motors by simultaneously pulling both sticks diagonally down-out. When the motors have completely stopped, release the joysticks.

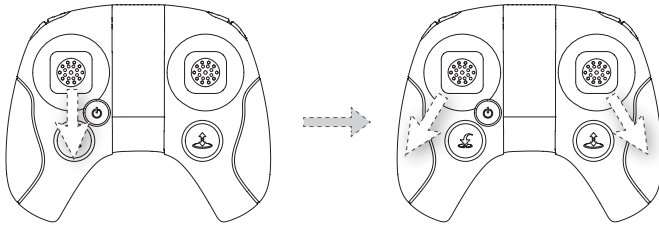

Auto Land: Press the Auto Land button and the aircraft will slowly descend to the ground.  
(Right hand figure)

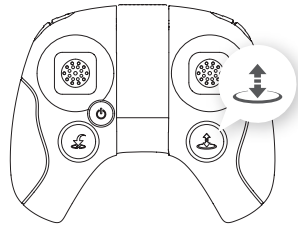

Return to Home: Tap the Return to Home icon and the aircraft will return to its takeoff point.  
(Right hand figure)



High speed propellers are very dangerous. Please keep the aircraft away from people, animate and inanimate objects.





Keep the aircraft under control at all times while the motors are still running.

Do not disarm during flight. The motors will stop in midair, causing the aircraft to fall and other such hazards. Only disarm during flight in the case of emergencies.

## 5.6 Basic flight operation

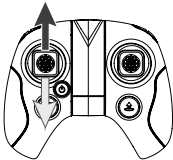
The remote control is by default set to Mode 2 in factory; this manual will introduce flight operations in Mode 2.

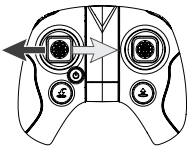
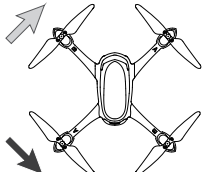
- Transmitter joysticks are self-centering and spring loaded: the joysticks will automatically center themselves
- Joystick sensitivity: dependent how much and how forcefully each joystick is pulled or pushed away from center point

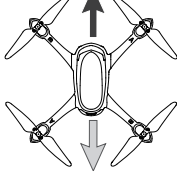
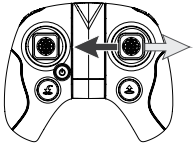
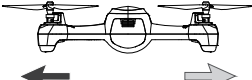
Remote Control (Mode 2)	Aircraft	Transmitter controls
	<p style="text-align: center;">Ascend</p>  <p style="text-align: center;">Descend</p>	<p>The throttle is used to control the ascent and descent of the aircraft. Push the throttle up and the aircraft ascends. Pull the throttle back and the aircraft descends. When the joystick is centered (unmoving), the aircraft will hold its altitude in the air. The throttle must be pushed upwards beyond center point for the aircraft to completely takeoff from the ground. The harder the throttle is pushed, the faster the aircraft will ascend. Please push the throttle slowly for a gradual lift and to prevent the aircraft from ascending erratically.</p>
	<p style="text-align: center;">Clockwise rotation</p>  <p style="text-align: center;">Counterclockwise rotation</p>	<p>The throttle is used to control the ascent and descent of the aircraft. Push the throttle up and the aircraft ascends. Pull the throttle back and the aircraft descends. When the joystick is centered (unmoving), the aircraft will hold its altitude in the air. The throttle must be pushed upwards beyond center point for the aircraft to completely takeoff from the ground. The harder the throttle is pushed, the faster the aircraft will ascend. Please push the throttle slowly for a gradual lift and to prevent the aircraft from ascending erratically.</p>
	<p style="text-align: center;">Forward</p>  <p style="text-align: center;">Backward</p>	<p>The elevator controls the aircraft's forward and backward movement. Push the joystick forward and the aircraft will tilt and fly forward. Pull the joystick back and the aircraft will tilt and fly backwards. When the joystick is centered (unmoving), the aircraft will hold its altitude in the air. How hard the elevator is pushed will determine the degree of the aircraft's tilt and therefore the velocity of its forward and backward movement. The harder the elevator is pushed, the greater the aircraft's tilt angle and flight speed either forwards or backwards.</p>
	 <p style="text-align: center;">Right                      Left</p>	<p>The aileron controls the aircraft's left and right movement. Push the joystick to the left and the aircraft will tilt and fly leftwards. Pull the joystick to the right and the aircraft will tilt and fly rightwards. When the joystick is centered (unmoving), the aircraft will hold its altitude in the air. How hard the aileron is pushed will determine the degree of the aircraft's tilt and therefore the velocity of its left and right movement. The harder the aileron is pushed, the greater the aircraft's tilt angle and flight speed either leftwards or rightwards.</p>

## Failsafe modes

### Low power failsafe

When the aircraft battery is low, there is likely insufficient power to support the return of the aircraft. Please land the aircraft immediately, otherwise the aircraft will fall and cause damage to the aircraft and surrounding objects. To prevent this, the aircraft flight control will use flight information to determine whether to perform a Return to Home or to land immediately.

Note: The aircraft will exit Return to Home if you move the joysticks. To continue the RTH, you must manually reactivate the function.

### Loss of flight control failsafe

When the flight control connection between the aircraft and transmitter is lost, the aircraft will automatically land or return to where the remote control/transmitter was last located and land there. This can drastically reduce the possibility of the aircraft crashing or being lost.

Conditions that may trigger a failsafe

- (1) Transmitter is powered off.
- (2) The flight distance exceeds the remote control's signal transmission range.
- (3) There is an obstacle between the remote control and aircraft.
- (4) The flight control or transmitter signal is interrupted by external electronic interference.

⊙ -To ensure the successful return of the aircraft if it loses flight control connection, users must confirm that the aircraft has enough GPS satellites to fly safely in GPS mode. Users must also be certain that the flight environment is clear enough for an emergency return and landing.

-If the aircraft's GPS satellites drop below 6 for more than 20 seconds while the X4 is returning to Home Point, the aircraft will automatically descend.

-The X4 cannot avoid obstacles automatically while in Failsafe mode. Users may set the Return to Home height to avoid running the aircraft into obstructions.

## Frequently Asked Questions

### 1. Cannot arm motors

- 1) Make sure that you have completed compass calibration
- 2) If you are flying indoors, please check the Settings menu to see if the aircraft can takeoff without GPS.

### 2. Weak or nonexistent GPS signal/few or no GPS satellites

Make sure that the aircraft is not indoors or between buildings. Please take the aircraft outdoors to receive GPS satellites/signal.

### 3. The aircraft flies erratically in Altitude Hold mode

- 1) Check to see if the air pressure sensor reading (Altitude telemetry value) is abnormal when the aircraft is motionless on flat ground. It should read 0 and fluctuate very little.
- 2) Check to see if the throttle joystick channel is moving appropriately and properly centered. If not, please calibrate the transmitter sticks and adjust the channel with the corresponding trim button (located on the transmitter).

### 4. Waypoint Mode does not work

- 1) Check that the aircraft has 6 or more satellites
- 2) Check that all joystick channels on-screen are properly centered.

### 5. Follow Me mode does not work

- 1) Check that the aircraft is in GPS Hold mode (Follow Me will not work without it)
- 2) Check that the aircraft has 6 or more satellites (Follow Me will not work otherwise)
- 3) Make sure that the all joystick channels are properly centered and that the joysticks are not moved while Follow Me mode is engaged or being engaged. (the aircraft will automatically exit Follow Me mode if a non-throttle joystick is moved or not centered)

### 6. The aircraft does not return to the home point

When the aircraft takes off, be sure that the aircraft has received 6 or more satellites.

### 7. The aircraft keeps on losing GPS satellites or GPS satellites drop to 0 erratically

Check to see whether there are sources of high-frequency signal interference around the aircraft (such as high-voltage lines, signal transmission towers, etc).

### 8. Aircraft/video feed is shaking/shaky

- 1) Check if the aircraft propellers are deformed or broken. Please replace them.
- 2) Check that all aircraft body screws are firmly in place.
- 3) Check whether any motor shafts are broken. Motors must be replaced if the shafts are broken.

### 9. Cannot take videos or pictures

- 1) Check to see that the SD card is installed in the aircraft prior to power on.
- 2) That the SD card is Class 10 or higher (UHS-1 suggested), less than 64GB of storage and formatted to FAT32.

### 10. Cannot connect to the aircraft's Wi-Fi

Restart the aircraft.



## H216A Accessories

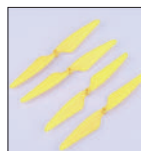

**H507A-03**  
Propeller A/B  
(Yellow)



**H502S-03**  
Propeller A/B  
(White)



**H502E-03**  
Propeller A/B  
(Red)

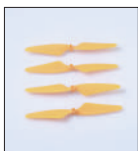

**H502D-03**  
Propeller A/B  
(Orange)



**H502-05**  
Motor A (coreless)



**H502-06**  
Motor B (coreless)



**H507A-04**  
Motor mounts  
(grey)



**H502-07**  
Motor mounts  
(white)



**H507D-04**  
Motor mounts  
(orange)



**H502-08**  
Shaft sleeves



**H502-10**  
Motor gears



**H502-11**  
Motor shafts



**H502-12**  
LEDs



**H216A-02**  
Flight Control PCB/  
Motherboard



**H216A-03**  
1080P Camera  
module/VTX

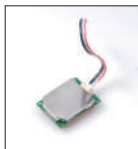

**H502-14**  
GPS module



**H501S-13**  
Compass module



**H216A-04**  
Battery



**H122D-12**  
USB charger



**H502-19**  
Screwdriver



**H502-20**  
Propeller guards



**H216A-01**  
H216A Body shell  
(top and bottom)



**H216A-05**  
HT009 transmitter



**H502-03**  
LED covers



**H502C-03**  
Screws



**H502S-07**  
Motor bearings



**Notice:** Read the instruction manual carefully before use.  
Propellers may cause injury; caution!

**Warning:** Do not leave the quadcopter charging unattended. Always disconnect the quadcopter from the charger immediately after charging is complete.  
This is not a toy and is not suitable for children under 14.

[www.HUBSAN.com](http://www.HUBSAN.com)

Product Name: X4 STAR PRO

Company: Shenzhen Hubsan Technology Co., Ltd.

Address: 13th Floor, Block 1, Tower C, Software Industry Base, Xuefu Road, Nanshan District, Shenzhen, China.

Factory: Dongguan Tengsheng Industrial Co., Ltd.

Address: A22# Luyi Street, Tianxin Village, Tangxia Town, Dongguan, China.

Hotline: 0769-82776166 (China)