

Leica BLK2FLY



User Manual
Version 1.0
English

- when it has to be **right**

Leica
Geosystems

PART OF
HEXAGON

Introduction

Validity of this manual

This manual applies to the BLK2FLY. Where there are differences between the standard setups they are clearly described.



This manual contains important safety directions as well as instructions for setting up the product and operating it. Refer to [2 Safety Directions](#) for further information.

Read carefully through the User Manual before you switch on the product.

The content of this document is subject to change without prior notice. Ensure that the product is used in accordance with the latest version of this document.

Trademarks

- *Bluetooth®* is a registered trademark of Bluetooth SIG, Inc.
- Apple, iPad, iPad Air, iPad Pro, and iPhone are trademarks of Apple Inc., registered in the U.S. and other countries.

All other trademarks are the property of their respective owners.

Available documentation

The documents in the following list are provided from Leica. Read and follow the instructions in these documents.

Name	Description/Format		
BLK2FLY Quick Guide	Provides an overview of the product together with technical data and safety directions. Intended as a quick reference guide.	✓	-
BLK2FLY User Manual	All instructions required in order to operate the product to a basic level are contained in the User Manual. Provides an overview of the product together with technical data and safety directions.	-	✓



<https://myworld.leica-geosystems.com> offers a wide range of services, information and training material.

With direct access to myWorld, you are able to access all relevant services whenever it is convenient for you.

The availability of services depends on the instrument model.

Service	Description
myProducts	Add all products that you and your company own and explore your world of Leica Geosystems: View detailed information on your products and update your products with the latest software and keep up-to-date with the latest documentation.
myService	View the current service status and full service history of your products in Leica Geosystems service centres. Access detailed information on the services performed and download your latest calibration certificates and service reports.

Service	Description
mySupport	Create new support requests for your products that will be answered by your local Leica Geosystems Support Team. View the complete history of your support requests and view detailed information on each request in case you want to refer to previous support requests.
myLearning	Welcome to the home of Leica Geosystems online learning! There are numerous online courses – available to all customers with products that have valid CCPs (Customer Care Packages).
myTrustedServices	Add your subscriptions and manage users for Leica Geosystems Trusted Services, the secure software services, that assist you to optimise your workflow and increase your efficiency.
mySmartNet	Exclusive to GS systems, HxGN SmartNet Global is a family of trustworthy correction services that are easily accessible, and they automatically enable the best possible accuracy everywhere. HxGN SmartNet Global family consists of three services: HxGN SmartNet Pro, HxGN SmartNet+ and HxGN SmartNet PPP.
myDownloads	Downloads of software, manuals, tools, training material and news for Leica Geosystems products.

Terms and abbreviations

The following terms and abbreviations can be found in this manual:

Term	Description
ARC	Air Risk Class
BLE	Bluetooth Low Energy
BVLOS	Beyond-Visual-Line of Sight
CoG	Centre of Gravity
ConOps	Concept of Operations
EASA	European Union Aviation Safety Agency
GNSS	Global Navigation Satellite System
GPS	Global Positioning System
GRC	Ground Risk Class
GUI	Graphical User Interface
IMEI	International Mobile Equipment Identity
JARUS	Joint Authorities for Rule-making on Unmanned Systems
PC	Personal Computer
LiPo	Lithium Polymer
LTE	Long-Term Evolution A standard for wireless broadband communication for mobile devices and data terminals.
MAC	Mid-air collision
MTOM	Maximum TakeOff Mass

Term	Description
OAT	Outside Ambient Temperature
OEM	Original Equipment Manufacturer
OSO	Operational Safety Objectives
RC	Remote Controller
RTCM	Radio Technical Commission for Maritime Services
RTK	Real Time Kinematic
SAIL	Specific Assurance and Integrity Level
SOC	State of Charge
SORA	Specific Operational Risk Assessment.
UA	Unmanned Aircraft
UAV	Unmanned Aerial Vehicle
UTM	UAV Traffic Management System
VLOS	Visual Line of Sight
WLAN	Wireless Local Area Network

DRAFT

Table of Contents

1	Usage Instructions and Necessary Training	7
2	Safety Directions	8
2.1	General Introduction	8
2.2	Definition of Use	9
2.3	Risks Related to Operation of a UAV	10
2.4	Limits of Use	10
2.5	Responsibilities	10
2.6	Hazards of Use	10
2.7	Electromagnetic Compatibility (EMC)	16
2.8	Scanning Laser	18
2.9	Laser Classification	18
3	Regulatory Situation	19
4	Product Overview	20
4.1	BLK2FLY Hardware	20
4.2	BLK2FLY Connectivity	21
4.3	BLK2FLY Software	22
4.4	Accessories	23
5	Description of Manufacturer	25
6	Description of the BLK2FLY	26
6.1	Performance Characteristics	26
6.2	Control of the BLK2FLY	26
6.3	Operational Limitations	26
6.3.1	Meteorological Conditions	26
6.3.2	Day/Night Operations	26
6.3.3	Environmental Considerations	26
6.4	Description of Lights	26
6.4.1	Instrument Status	27
6.4.2	Smart Battery GEB374	30
6.5	Description of Data Link	30
6.6	Safety Features	30
6.7	Obstacle Avoidance	30
6.8	Payload	31
6.9	Hazard Assessment	31
7	Description of the Application, Mission Planning	37
7.1	Start Up Screens	37
7.2	Pairing	37
7.3	Menu WELCOME	39
7.4	Status Bar	40
7.5	Icons	41
7.6	Hamburger Menu	47
7.6.1	Live View Screen	48
7.6.2	3D View Screen	49
7.6.3	Map View Screen	51
7.6.4	Project Browser Screen	52
7.6.5	AIRSPACE INFORMATION Screen	53
7.6.6	Battery Management Screen	55
7.6.7	Settings Screen	56
7.6.7.1	Profile Screen	57
7.6.7.2	BLK2FLY Screen	58
7.6.7.3	Scanning Screen	65

	7.6.7.4	Flight Screen	68
	7.6.8	Support Screen	72
7.7		Scan Modes	75
	7.7.1	Manual Recording	76
	7.7.2	Surface Recording	79
	7.7.3	Area Recording	83
8	Alerts, Geo-awareness, Operational Information		87
8.1	Description of Alerts, Warnings and Information		87
8.2	Geo-awareness System, Fencing		90
	8.2.1	Geo-awareness System	90
	8.2.2	Fencing	90
9	Description of Further Components		93
9.1	Battery		93
9.2	Single Charger		93
9.3	Multi-charger		93
10	Operation		94
10.1	Setup Procedures		94
	10.1.1	Airspace Limitations	94
	10.1.2	Firmware Updates	94
	10.1.3	Configure GNSS RTK	94
10.2	Preparation Procedures		94
10.3	Pre-flight Procedures		95
10.4	Compass Calibration		95
10.5	Flight Procedures		99
10.6	Post-flight Procedures		100
10.7	Occurrence Reporting		101
11	Maintenance		102
11.1	Maintenance Plan		102
11.2	Manufacturer Repair		103
11.3	Maintenance Recordkeeping		103
11.4	Recommended Training		103
12	Troubleshooting		104
13	Care and Transport		106
13.1	Storage		106
13.2	Cleaning and Drying		106
	13.2.1	Dome Cleaning Procedure	106
13.3	Transport		107
14	Technical Data		108
14.1	BLK2FLY		108
14.2	Smart Battery GEB374		111
14.3	Tablet		111
14.4	BLK2FLY System Certificates		112
	14.4.1	EU Declaration of Conformity	112
14.5	Conformity to National Regulations		113
	14.5.1	Labelling	113
	14.5.2	BLK2FLY Aircraft	113
14.6	Dangerous Goods Regulations		117
15	Software Licence Agreement/Warranty		119

- Read carefully through the User Manual before you switch on the product
 - Perform your first flights in obstacle free, open area to familiarise yourself with the BLK2FLY
 - Get an appropriate license & operator registration. Refer to [3 Regulatory Situation](#) for details
 - Comply with all applicable laws. Refer to [3 Regulatory Situation](#) for details
 - Application training offered by Leica Geosystems is recommended for BLK2FLY
-

DRAFT

2

Safety Directions

2.1

General Introduction

Description

The following directions enable the person responsible for the product, and the person who actually uses the equipment, to anticipate and avoid operational hazards.

The person responsible for the product must ensure that all users understand these directions and adhere to them.

About warning messages





Warning messages are an essential part of the safety concept of the instrument. They appear wherever hazards or hazardous situations can occur.

Warning messages...

- make the user alert about direct and indirect hazards concerning the use of the product.
- contain general rules of behaviour.

For the users' safety, all safety instructions and safety messages shall be strictly observed and followed! Therefore, the manual must always be available to all persons performing any tasks described here.

DANGER, WARNING, CAUTION and **NOTICE** are standardised signal words for identifying levels of hazards and risks related to personal injury and property damage. For your safety, it is important to read and fully understand the following table with the different signal words and their definitions! Supplementary safety information symbols may be placed within a warning message as well as supplementary text.

Type	Description
 DANGER	Indicates an imminently hazardous situation which, if not avoided, will result in death or serious injury.
 WARNING	Indicates a potentially hazardous situation or an unintended use which, if not avoided, could result in death or serious injury.
 CAUTION	Indicates a potentially hazardous situation or an unintended use which, if not avoided, may result in minor or moderate injury.
 NOTICE	Indicates a potentially hazardous situation or an unintended use which, if not avoided, may result in appreciable material, financial and environmental damage.
	Important paragraphs which must be adhered to in practice as they enable the product to be used in a technically correct and efficient manner.

Additional symbols



Warning against explosive material.



Warning against flammable substances.



Product must not be opened or modified or tampered with.



Indicates the temperature limits at which the product may be stored, transported or used.

2.2

Definition of Use

Intended use

- Scanning objects
- Measuring horizontal and vertical angles
- Measuring distances
- Capturing and recording images
- Recording measurements
- Computing with software
- Remote control of product
- Data communication with external appliances

Reasonably foreseeable misuse

- Operate the product without training by Leica Geosystems or an approved partner
- Operate the aircraft in a declared **No Fly Zone** without permission
- Operate the aircraft without governmental authorisation
- Use of the product without instruction
- Use of product as a sole source of information for navigation
- Use outside of the intended use and limits
- Disabling/bypassing of safety systems
- Removal of hazard notices
- Opening the product using tools, for example a screwdriver, unless this is permitted for certain functions
- Modification or conversion of the product
- Use after misappropriation
- Inadequate safeguards at the working site
- Use with accessories from other manufacturers without the prior written explicit approval of Leica Geosystems
- Use of products with recognisable damage or defects

Information on flight warnings

- Ensure that all parts are in good condition before each flight. DO NOT fly with worn or damaged parts
- If the pilot disabled the obstacle avoidance limitation, he must manually maintain a safe distance from people, buildings, high-voltage power lines, tall trees, water and other hazards when flying the aircraft.
- Even the BLK2FLY is rated IP54, flying while raining/snowing is prohibited
- DO NOT add extra weight to the BLK2FLY
- DO NOT go near or touch the propellers while they are spinning. It can cause serious injuries
- DO NOT attach 3-rd party equipment to the BLK2FLY
- Respect system limitations
- Disconnect the battery during transportation to avoid damage or injury

2.3

Risks Related to Operation of a UAV

Refer to [2.6 Hazards of Use](#) for details.

- For example, weather
 - Interferences
 - Human error in handling
 - Operations near people
 - Unauthorised modifications to the BLK2FLY
 - Inattentiveness during flight
 - Injuries
-

2.4

Limits of Use

Environment

Suitable for use in an atmosphere appropriate for permanent human habitation. Not suitable for use in aggressive or explosive environments.

WARNING

Working in hazardous areas, or close to electrical installations or similar situations

Life Risk.

Precautions:

- ▶ Local safety authorities and safety experts must be contacted by the person responsible for the product before working in such conditions.
-

2.5

Responsibilities

Manufacturer of the product

Leica Geosystems AG, CH-9435 Heerbrugg, hereinafter referred to as Leica Geosystems, is responsible for supplying the product, including the User Manual and original accessories, in a safe condition.

Person responsible for the product

The person responsible for the product has the following duties:

- To ensure that the national laws, regulations and conditions for the operation of the product are respected
 - To understand the safety instructions on the product and the instructions in the User Manual
 - To ensure that it is used in accordance with the instructions
 - To be familiar with local regulations relating to safety and accident prevention
 - To stop operating the system and inform Leica Geosystems immediately if the product and the application become unsafe
 - To be accountable for the training and the deployment of personnel who use the product and for the safety of the equipment in use
 - To ensure that it is allowed to use the product in the planned area of operation
 - To maintain the protection of privacy
-

2.6

Hazards of Use

General

The BLK2FLY may only be operated after instruction, training and certification by Leica Geosystems or an approved partner.

Despite of all automatic functions and safety technology, the operator is the sole responsible person for the safe flight and the final take-off decision.

WLAN interference

The BLK2FLY may not carry any WLAN enabled equipment. This restriction includes cellphones or similar devices.

Anything operating wirelessly on other frequencies may only be used with the express written consent of Leica Geosystems. If you ignore this warning, any warranty will be void.

DANGER

Fire from overheated parts or batteries

The aircraft or parts of it may fall on ground during flight.

Precautions:

- ▶ Immediately start a landing routine as soon as fire is recognised.
- ▶ Make sure to not hit any obstacles while returning to ground.
- ▶ Keep visual contact with the aircraft at all times.

DANGER

Rotating Blades

Risk of serious injuries due to cut-off or crushing fingers.

Precautions:

- ▶ Keep away from blades while equipment is in operation.
- ▶ Disconnect the battery before working on the blades.

DANGER

Crash due to a general malfunction

Risk of serious injuries and damages because of falling device.

Precautions:

- ▶ Do not fly above humans.
- ▶ Do not fly above dangerous places.

DANGER

Crash due to interfering signals

Interfering signals can lead to malfunction of the device. Risk of serious injuries and damages because of falling device.

Precautions:

- ▶ Do not fly in the vicinity of airports, military installations or strong transmitters.
 - ▶ To avoid interference, maintain a minimum distance of 5 kilometres from these areas.
-

 **DANGER**

Obviously recognizable damages or defects

This may result in adverse effect while flying the aircraft. Aircraft or parts of it may fall down on ground.

Precautions:

- ▶ Make sure the assembly of the aircraft shows no damages.
- ▶ Check every part of the aircraft after any crash or violent impact. If any problems or questions arise, contact your local Leica Geosystems customer support.

 **DANGER**

Critical low batteries

Crash landing due to critical low batteries. Risk of serious injuries and damages because of falling device. To prevent a crash landing due to low batteries, the BLK2FLY starts an automatic descent depending on the current altitude. Once started, this procedure cannot be interrupted. Controlling the position and heading is possible.

Precautions:

- ▶ Always monitor the battery state of charge of the batteries.
- ▶ Respect the warning signals for low batteries.
- ▶ Keep in mind to plan an energy reserve for coming back and landing.
- ▶ Environmental conditions, for example wind, are not taken into account when automatic reserve planning is done.
- ▶ Be aware of, that the diversion from direct flight trajectory due to obstacle avoidance is not taken into account for reserve planning.

 **DANGER**

Crash due to own downwash

The device can fly in his own turbulences. Risk of serious injuries and damages because of falling device.

Precautions:

- ▶ Avoid a straight vertical descent.
- ▶ Descend in spiral movements or in a 'zig-zag' motion.
- ▶ Be aware of the downwash of the rotor blades when flying near ground.

 **DANGER**

Crash due to weak batteries at low outdoor temperatures

At low outdoor temperatures, the batteries cannot provide their full energy. Risk of serious injuries and damages because of falling device.

Precautions:

- ▶ Respect the general limitations.
- ▶ Keep batteries warm before operating the device at low outdoor temperatures.
- ▶ Do not fly batteries which are colder than 10 °C. Flight time is shortened.

DANGER

Crash due to overheating motors or electronics

At high outdoor temperatures, the motors or parts of the electronics can overheat. Risk of serious injuries and damages because of falling device.

Precautions:

- ▶ Respect the general limitations.
- ▶ Shorten your flights at temperatures above 30 °C OAT.
- ▶ Maintain a cool-down phase between flights.
- ▶ Do not store the system in direct sunlight.
- ▶ Land immediately if a temperature warning appears.

DANGER

Mental fatigue of the operator

The operation of the BLK2FLY causes considerable mental fatigue. Failure to observe these precautions may cause the operator to lose concentration and lead to a crash landing, accident.

Precautions:

- ▶ Take a rest on a regular base.
- ▶ Only fly the UAV if you are in good mental condition.

DANGER

Hazards due to glaring sun

The glaring sun can compromise your eyesight and may lead to an accident. Also a permanent view to the sky on a bright day may stress your eyes.

Precautions:

- ▶ Do not fly longer than 2 hours without taking a rest.
- ▶ Always have sun glasses with you, to protect your eyes against the sunlight.
- ▶ If possible, consider the position of the sun when choosing the position of the operator. Make sure that no glare occurs during the mission.

DANGER

Fly in restricted area

Flying in restricted areas may result in non-compliant behaviour, serious injury and property damage.

Precautions:

- ▶ Keep enough distance to aircraft, including other UAV, regardless of altitude.
- ▶ Avoid flying the aircraft in densely populated areas, including cities, sporting events, exhibitions, performances, and so on.
- ▶ Fly the aircraft only within authorised airspace. Remain well clear of and do not interfere with aircraft, including other UAV, operations.
- ▶ Be aware of and avoid other aircraft and obstacles at all times.

⚠ DANGER

Unplanned start of the motors

Sudden start of propellers while working close at the UAV may lead to serious injuries.

Precautions:

- ▶ Avoid touching areas near propellers when UAV is powered.
- ▶ Block Apple iPad screen when not intended to fly or manage BLK2FLY.

⚠ WARNING

Adverse weather condition

Crash landing due to adverse weather conditions

Precautions:

- ▶ Do not use the aircraft in adverse weather conditions including rain, snow, fog and wind speeds exceeding 12 m/s.
- ▶ Expect stronger winds and turbulence when operating close to the objects.

⚠ WARNING

Overheating Batteries

Risk of explosion or fire.

Precautions:

- ▶ Protect batteries against high temperatures.
- ▶ Always use the provided battery charger.

⚠ WARNING

Short circuit of battery terminals

Risk of fire, electric shock and damage.

Precautions:

- ▶ Do not open the battery housing.
- ▶ Keep away any metallic or wet objects from the battery terminals.

⚠ WARNING

Hazards due to obstacles in the environment

During flight operations, there is a danger of accidents occurring if the user does not pay attention to the surrounding environment including both, the airspace and the ground space of the operating area.

Precautions:

- ▶ Take extra care when changing your position while operating the product.
- ▶ A trained and briefed observer is always recommended to assist the operator with environment monitoring.

WARNING

Improper disposal of product

If the product is improperly disposed of, the following can happen:

- If polymer parts are burnt, poisonous gases are produced which may impair health.
- If batteries are damaged or are heated strongly, they can explode and cause poisoning, burning, corrosion or environmental contamination.
- By disposing of the product irresponsibly you may enable unauthorised persons to use it in contravention of the regulations, exposing themselves and third parties to the risk of severe injury and rendering the environment liable to contamination.

Precautions:



The product must not be disposed with household waste. Dispose of the product appropriately in accordance with the national regulations in force in your country. Always prevent access to the product by unauthorised personnel.

WARNING

Use of product with radio devices

Electromagnetic fields can cause disturbances in other equipment, in installations, in medical devices, for example pacemakers or hearing aids. It can also affect humans and animals.

Precautions:

- ▶ Although the product meets the strict regulations and standards which are in force in this respect, Leica Geosystems cannot completely exclude the possibility that other equipment can be disturbed or that humans or animals can be affected.
- ▶ Do not operate the product with radio devices in the vicinity of filling stations or chemical installations, or in other areas where an explosion hazard exists.
- ▶ Do not operate the product with radiodevices near to medical equipment.

WARNING

Sensors may provide wrong data

If the environmental information is inconsistent or not comprehensive, malfunction may occur. The functionality of some Safety Features relies on the information of one or more of the following sensors: Pressure Sensor, Ultrasonic Sensor, GNSS receiver, Magnetic Compass.

Precautions:

- ▶ Be aware that sensors may provide wrong data and always be ready to take over manual control.
- ▶ Always keep aircraft within visual line of sight.

CAUTION

Wet equipment

Operating wet equipment leads to damage or malfunction of the instrument.

Precautions:

- ▶ Do not power on the BLK2FLY system during cleaning and drying process.
- ▶ Do not connect power cables to the power source.
- ▶ If the equipment becomes wet, leave it unpacked.
- ▶ Move it to an environment with low humidity.
- ▶ Dry wet components, the container, the foam inserts and the accessories at a temperature not greater than +40 °C/+104 °F and clean them thoroughly.
- ▶ Do not repack until everything is dry.

NOTICE

Electric shock from electrostatic discharge

Risk from lightning exists while working during thunderstorm conditions. The aircraft may get electrostatic charged during flight. As a result electrostatic discharge may occur when touching the aircraft on ground.

Precautions:

- ▶ Never fly during thunderstorm conditions.
- ▶ Land aircraft as soon as possible if sudden thunderstorm conditions appear.

NOTICE

Misted optics

Due to sudden temperature differences it may happen that humidity is built up on the optics. This results in misted view.

Precautions:

- ▶ Make sure there was sufficient time for the equipment to reach ambient temperature before the mission starts.
- ▶ Perform visual inspection of optics before the flight.

2.7

Electromagnetic Compatibility (EMC)

Description

The term Electromagnetic Compatibility is taken to mean the capability of the product to function smoothly in an environment where electromagnetic radiation and electrostatic discharges are present, and without causing electromagnetic disturbances to other equipment.

WARNING

Electromagnetic radiation

Electromagnetic radiation can cause disturbances in other equipment.

Precautions:

- ▶ Although the product meets the strict regulations and standards which are in force in this respect, Leica Geosystems cannot completely exclude the possibility that other equipment may be disturbed.

CAUTION

Use of the product with accessories from other manufacturers. For example, field computers, personal computers or other electronic equipment, non-standard cables or external batteries

This may cause disturbances in other equipment.

Precautions:

- ▶ Use only the equipment and accessories recommended by Leica Geosystems.
- ▶ When combined with the product, other accessories must meet the strict requirements stipulated by the guidelines and standards.
- ▶ When using computers, two-way radios or other electronic equipment, pay attention to the information about electromagnetic compatibility provided by the manufacturer.

CAUTION

Intense electromagnetic radiation. For example, near radio transmitters, transponders, two-way radios or diesel generators

Although the product meets the strict regulations and standards which are in force in this respect, Leica Geosystems cannot completely exclude the possibility that the function of the product may be disturbed in such an electromagnetic environment.

Precautions:

- ▶ Check the plausibility of results obtained under these conditions.

Radios or digital cellular phones

WARNING

Use of product with radio or digital cellular phone devices

Electromagnetic fields can cause disturbances in other equipment, installations, medical devices, for example pacemakers or hearing aids, and aircrafts. Electromagnetic fields can also affect humans and animals.

Precautions:

- ▶ Although the product meets the strict regulations and standards which are in force in this respect, Leica Geosystems cannot completely exclude the possibility that other equipment can be disturbed or that humans or animals can be affected.
- ▶ Do not operate the product with radio or digital cellular phone devices in the vicinity of filling stations or chemical installations, or in other areas where an explosion hazard exists.
- ▶ Do not operate the product with radio or digital cellular phone devices near medical equipment.
- ▶ Do not operate the product with radio or digital cellular phone devices in aircrafts.
- ▶ Do not operate the product with radio or digital cellular phone devices for long periods with the product immediately next to your body.

2.8

Scanning Laser

General

The laser incorporated in the product produces an invisible beam which emerges from the rotating mirror.

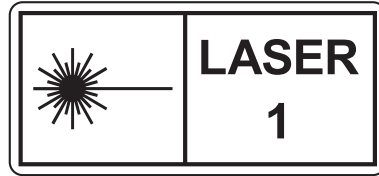

The laser product described in this section is classified as laser class 1 in accordance with:

- IEC 60825-1 (2014-05): "Safety of laser products"

These products are safe under reasonably foreseeable conditions of operation and are not harmful to the eyes provided that the products are used and maintained in accordance with this User Manual.

Description	Value
Wavelength	830 nm
Maximum pulse energy	9 nj
Pulse duration	3 ns
Pulse repetition frequency (PRF)	1.64 MHz
Beam divergence (FWHM, full angle)	0.5 mrad
Mirror rotation	100 Hz
Base rotation	2.5 Hz

2.9

Laser Classification

Laser products and location of laser apertures

Laser product	Laser class	Classification
EDM, Electronic Distance Measurement	Class 1	IEC 60825-1:2014

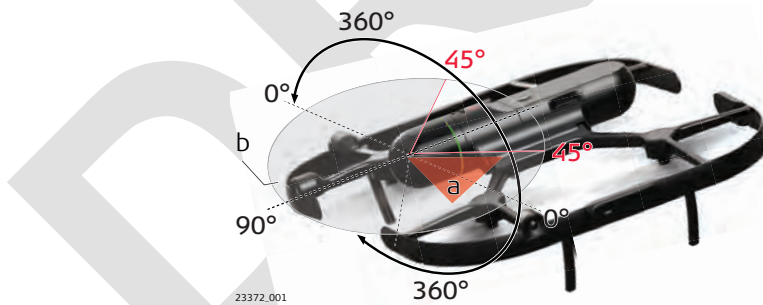

- a Laser beam
- b Scanning laser beam

Overview

- UAV pilots/operators are responsible to comply with local regulations and to obtain necessary approvals from authorities and/or land owners
 - It is the sole responsibility of the user who operates the aircraft to provide for correct operator registration and compliance of the legal regulations for the system at the location of the flight execution.
 - It is the sole responsibility of the user who operates the aircraft to have an appropriate license.
 - It is the sole responsibility of the user who operates the aircraft to comply with all applicable laws.
 - Leica is not responsible where and when the aircraft is operated. It is the sole responsibility of the user.
 - The cameras installed on the BLK2FLY record images during flight. As these images might have privacy implications, the operator is responsible for checking that they do not violate privacy laws.
 - The legal use of the following system components must be checked before flight execution:
 - BLK2FLY
 - Apple iPad
 - Video Transmitter
 - Interface for telemetry data
 - In order to fly the UAV, pilots/operators may need to register the UAV with the local Civil Aviation Authority and may have to comply with Remote ID requirements and all applicable laws
 - Leica is strongly recommending to check the following links:
 - EASA: [EASA - UAV Information Notices](#)
 - FAA: https://www.faa.gov/uas/getting_started/
 - Transport Canada: <https://tc.canada.ca/en/aviation/drone-safety>
 - CAA UK: <https://caa.co.uk/drones>
 - Do not endanger other people or traffic and do not fly over people or traffic without a specific authorisation
 - Do not invade the privacy of people during the flight and avoid flights where uninvolved people might feel their privacy invaded
 - Stay within the operational limitations of the UAV
-

4

Product Overview

4.1

BLK2FLY Hardware

Top view

Main components of the BLK2FLY hardware



- a LTE antenna: Diversity
- b 3D LiDAR: Mapping, obstacle avoidance
- c Side camera: SLAM, mapping, user Live View
- d WLAN antenna
- e Side radar: Side obstacle perception
- f Rear radar: Rear obstacle perception
- g Front camera: SLAM, mapping, user Live View
- h Top camera: SLAM, mapping, user Live View
- i GNSS antenna
- j Power: ON. To turn the BLK2FLY off, remove battery
- k Battery: Smart Battery GEB374, hot-swap (< 10 s)
- l LTE antenna: Main

Hot-swap

The BLK2FLY is switched on. Swap a used battery against a charged battery within < 10 s without the need of rebooting the BLK2FLY.

Bottom view



- a Bottom camera: SLAM, mapping, user Live View
- b Folding joint: Compact transportation
- c Motor and 10" propeller: Producing lift
- d Landing gear, 4 ×
- e Time-of-Flight sensor: Distance to ground

Interfaces



23347.001

- a USB Type-C connector: Flight data transfer
- b SIM card: LTE communication

BLK2FLY, position LED

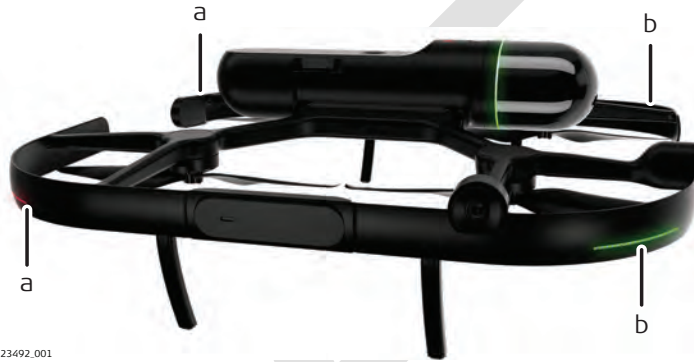

23492.001

- a Rear position LED – red
- b Front position LED – green

4.2

BLK2FLY Connectivity

Description

Schematic overview

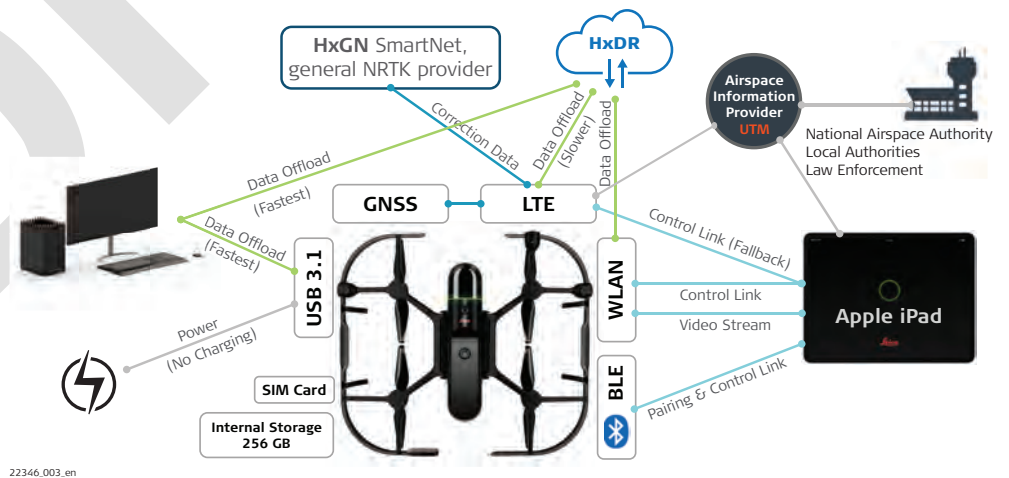

22346.003_en

Type	Details
Apple iPad	<ul style="list-style-type: none"> • Easy and fast pairing between BLK2FLY and Apple iPad • Video streaming, Live View on the Apple iPad • Control link to navigate the BLK2FLY • Control link (fallback) in case communication by WLAN gets interrupted • Communication with airspace information provider
BLE	<ul style="list-style-type: none"> • Easy and fast pairing between BLK2FLY and Apple iPad
WLAN	<ul style="list-style-type: none"> • Video streaming, Live View on the Apple iPad • Control link to navigate the BLK2FLY by the Apple iPad • Data offload from the BLK2FLY to the HxDR (hxdr.com)
LTE	<ul style="list-style-type: none"> • Control link (fallback) - in case communication by WLAN gets interrupted • Receives correction data from the HxGN SmartNet or any other NRTK provider for the GNSS. RTK positioning in [cm]-resolution results
HxDR	<ul style="list-style-type: none"> • Receives data by direct upload either by WLAN and/or LTE and/or computer. Refer to hxdr.com for more information
USB 3.1	<ul style="list-style-type: none"> • Offline data upload from BLK2FLY to computer • Powering BLK2FLY without inserted battery for longer wireless offload periods
Airspace Information Provider	<p>For example: AIRMAP is a UTM provider. These providers interface with National Agencies and provide data.</p> <ul style="list-style-type: none"> • Display permitted airspace • Display No-Fly zones • Actively restrict users. Take off is not prevented, but information is provided on where it is permitted to fly or where it is not permitted <p>The Airspace Information Provider also offers the Network Remote ID requirement. In future, it will be possible to publish the position of the UAV through the Internet.</p>
SIM Card	SIM card must not have a SIM lock. Remove SIM lock by using for example a mobile phone before usage with BLK2FLY.
Internal Storage	<ul style="list-style-type: none"> • 256 GB • 5.5 h of data recording

4.3

BLK2FLY Software

BLK2FLY Live



Install this application on the Apple iPad to control the BLK2FLY. Refer to [7 Description of the Application, Mission Planning](#) for more information.

Apple App store



BLK2FLY Live app can only be updated over the Apple App store.

Type	Ordering number	Detail
Single charger Leica GKL352	921 167	
Multi-charger, available in 2022	889 087	<p>Charge up to five batteries simultaneously.</p> <p>The information/control of the battery is done by the BLK2FLY Live app:</p> <ul style="list-style-type: none"> • Charging state • Notification once the battery is fully charged • Option to automatically discharge to 60% for storage purpose 
Smart Battery GEB374	898 972	<p>Capacity < 99.9 Wh LiPo (Lithium-Ion-Polymer)</p> 
Hardcase Trolley	938 387	<p>Carries following items:</p> <ul style="list-style-type: none"> • BLK2FLY • Apple iPad • Multi-charger • Up to five batteries 

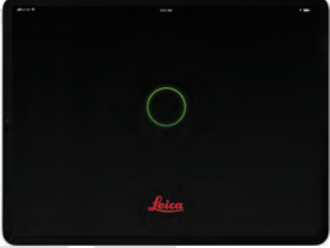
Type	Ordering number	Detail
Apple iPad		<ul style="list-style-type: none">• Not sold by Leica• Apple iPad with LTE support <p> The BLK2FLY can only be flown with the Apple iPad.</p> 

DRAFT

Description of Manufacturer

We, Leica Geosystems AG, as the manufacturer of the BLK2FLY are designing and verifying our products against all technical and legal aspects. We have a proper process management in place acc. ISO9001 and this contains a well-documented and implemented innovation process. This process follows the best practices from all industries and has also certain milestone gates to ensure the safety and compliance of our products throughout all life phases.

DRAFT

6 Description of the BLK2FLY

6.1 Performance Characteristics

Refer to [Flight performance](#) for details.

6.2 Control of the BLK2FLY

Overview

The application BLK2FLY Live, installed on the Apple iPad, is the only way to remote control the BLK2FLY. There is no hardware remote control with mechanical joysticks similar to other UAV.

Refer to [7 Description of the Application, Mission Planning](#) for more details.

This application must be installed on an Apple iPad. To install, download the application from the iOS App-Store.

6.3 Operational Limitations

Exceeding certain operational conditions can be dangerous.

6.3.1 Meteorological Conditions

Follow these conditions when flying the BLK2FLY:

- Do not use the aircraft in adverse weather conditions including rain, snow, fog, icing conditions, hail and wind speeds exceeding 12 m/s
 - Aircraft and battery performance are subject to environmental factors such as air density and temperature. Flying at an altitude above 1800 m above sea level is not supported
-

6.3.2 Day/Night Operations

Flying in the dark is not permitted.

The BLK2FLY can only fly under normal daylight conditions. Since it navigates visually, it does not work at night or in other low-light conditions.

6.3.3 Environmental Considerations

A very high degree of caution is required with a high level of risk when flying in areas with high levels of electromagnetism, including mobile phone base stations and radio transmission towers and electrical utility substations.

NOTICE

Avoid flying near obstacles, individuals and crowds, high voltage power lines, trees and bodies of water.

6.4 Description of Lights

Following LED can be identified at the BLK2FLY:

- BLK2FLY ring-shaped LED indicating operation states.
Refer to [6.4.1 Instrument Status](#) for details
 - BLK2FLY position LED.
Refer to [BLK2FLY,position LED](#) for details
 - Smart Battery GEB374 status LED.
Refer to [6.4.2 Smart Battery GEB374](#) for details
-

6.4.1

Instrument Status

LiDAR light guide

The ring-shaped LED lights up in different colours and lighting intervals to show the operation states of the BLK2FLY.



Description	Details
Colours	<ul style="list-style-type: none"> • Green • Yellow • Red • Blue
Lighting intervals	<ul style="list-style-type: none"> • Continuous/static • Fade in/fade out • Blinking • Pulsating

Wing light guide

The wing LEDs, position lights, light up to show the operation states of the BLK2FLY and indicate the orientation of the UAV in air.

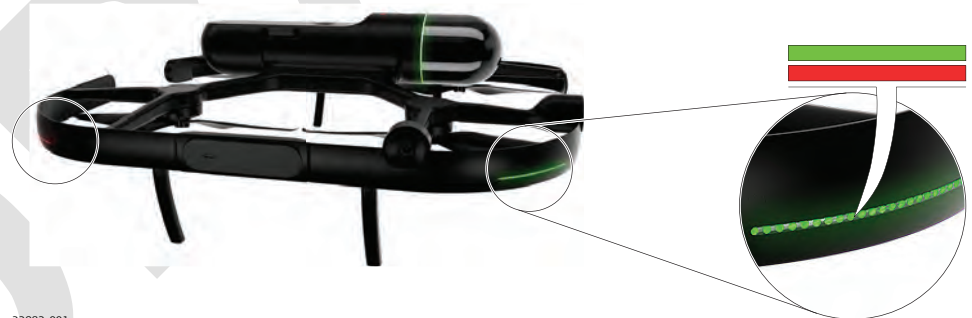

Description	Details
Colours	<ul style="list-style-type: none"> • Green: Front LED • Red: Rear LED
Lighting intervals	<ul style="list-style-type: none"> • Continuous/static • Fade in/fade out • Blinking • Pulsating

Operation mode

BLK2FLY – battery powered

State/action	LiDAR light guide	Wing light guides
The BLK2FLY is off.	None.	None.
Booting up.	Fade in to 100% brightness, then 0.5 Hz pulsating 100% / 10% brightness during boot up → Yellow	0.5 Hz pulsating 40% / 10% brightness during boot up.
Pairing mode. Waiting for connection.	Alternate between 2 Hz blinking and 1 s pause 100% / 0% brightness → Blue	Static, 40% brightness.
Pairing mode. Pairing successful.	2 Hz blinking for 2 s 100% / 0% brightness → Green	Static, 40% brightness.
Idle. On ground. The BLK2FLY is ready.	Static, 100% brightness → Green	Static, 40% brightness.
Idle. The BLK2FLY is not ready to take-off. Possible reasons: Can be high tilt or wings not being unfolded completely.	Static, 100% brightness → Yellow	Static, 40% brightness.
Prepare for take-off. While pressing take-off button.	2 Hz blinking 100% / 0% brightness → Yellow	Fade from current brightness to 100% brightness (+40%/s).
Take-off abort.	Static, 100% brightness → Green	Fade from current brightness to 40% brightness (-40%/s).
Free flight.	Static, 100% brightness → Green	Static, 100% brightness.
Recording data. Independent on flight mode.	0.5 Hz pulsating 100% / 10% brightness → Green	Just displays the current active flight mode. If recording data during manual flying is active, it displays the free flight pattern. If recording during an automated scan mission is active, it shows the scan mission wing LED pattern.
Automated flight/scan mission.	N/A – idle pattern if not recording data.	2 Hz pulsating reciprocally with both sectors 100% / 40% brightness.
Automated landing. Final, vertical part.	2 Hz blinking 100% / 0% brightness → Yellow	2 Hz blinking 100% / 0% brightness.

State/action	LiDAR light guide	Wing light guides
Hot-swap the Smart Battery GEB374.	1 Hz pulsating 100% / 20% brightness Colour depending on time passed since removing battery 0–3 s → Green 3–6 s → Yellow > 6 s → Red	Turned off.
Error, critical problem or major failure. Contact a Leica Geosystems authorised Service Centre for further investigation.	1 Hz blinking 100% / 0% brightness → Red	1 Hz blinking 20% / 5% brightness.

Mag calibration

State/action	LiDAR light guide	Wing light guides
Keep rotating.	0.5 Hz pulsating 100% / 10% brightness → Green	0.5 Hz pulsating.
Next step/wrong direction.	2 Hz blinking 100% / 0% brightness → Yellow	2 Hz blinking.
Rotating too fast.	0.5 Hz pulsating 100% / 10% brightness → Yellow	0.5 Hz pulsating.
Finished calibration.	2 Hz blinking for 10 s 100% / 0% brightness → Green	2 Hz blinking for 10 s.

BLK2FLY – USB-C powered

State/action	LiDAR light guide	Wing light guides
USB Type-C connector cable plugged in, booting up.	Fade in to 100% brightness, then 0.5 Hz pulsating 100% / 10% brightness during boot up → Yellow	Turned off.
Idle.	Static, 100% brightness → Green	Turned off.
File sync in progress.	0.3 Hz pulsating 100% / 10% brightness → Yellow	Turned off.
Power not sufficient. For example: USB 2.0	1 Hz blinking 100% / 0% brightness → Red	Turned off.

6.4.2

Smart Battery GEB374

Smart Battery GEB374, LED description

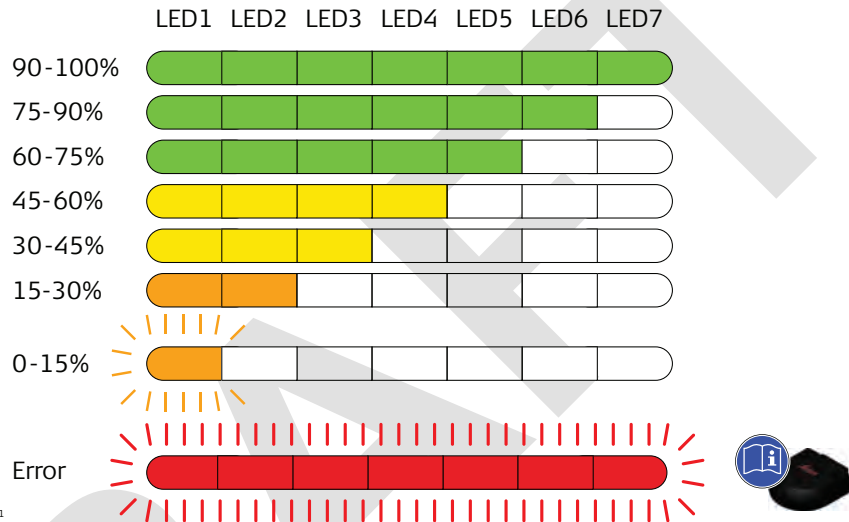

23484_001

In case of an error, refer to the Leica GKL352 User Manual

6.5

Description of Data Link

Refer to chapter 4.2 BLK2FLY Connectivity.

6.6

Safety Features

Overview

Most errors in BLK2FLY operations are human errors. Refer to 2.6 Hazards of Use for details.

6.7

Obstacle Avoidance

Obstacle avoidance coverage works 360° around the BLK2FLY combining LiDAR and radar data.

Obstacle avoidance avoids obstacles that are not in motion. If obstacles like cars, boats, balls, animals, other UAV, other people, or similar are moving, they are not actively avoided.

The BLK2FLY cannot see certain visually challenging obstacles.

- Do not fly around thin branches, telephone or power lines, ropes, netting, wires, chain link fencing or other objects less than 5 mm in diameter
- Radar does not reliably detect very thin objects like cardboard or small tree branches. It might miss glossy, transparent or dark surfaces

6.8

Payload

No additional payloads are allowed on the BLK2FLY.

6.9

Hazard Assessment

List of possible hazards

Unintentional propeller start

Safety risk	Possible effects/ consequences	Mitigations
Injury due to accidental/unplanned propeller start while performing direct procedure (battery change).	Moderate injuries, BLK2FLY damage.	<ul style="list-style-type: none"> • Lock the screen of Apple iPad when operating • While BLK2FLY is ON, avoid touching areas near propellers

Battery Fire

Safety risk	Possible effects/ consequences	Mitigations
Battery gets fire while charging.	Property fire damage.	<ul style="list-style-type: none"> • Only charge using Leica BLK2FLY charger • Never leave charging batteries unattended • Use LiPo safety container/bag when charging • Appropriate fire safety equipment in charging area • Emergency procedures are defined and set
Battery gets fire during exchange/transportation.	Property fire damage.	<ul style="list-style-type: none"> • Use LiPo safety container/bag when acceptable • Appropriate fire safety equipment is accessible • Emergency procedures are defined and set
Post-crash battery fire.	Property fire damage, environmental damage.	<ul style="list-style-type: none"> • Fire safety equipment is in place • Avoid flying over hazardous areas • Utilise geofence • Emergency procedures are defined and set

Battery Failure

Safety risk	Possible effects/ consequences	Mitigations
Battery overheat.	<ul style="list-style-type: none">Emergency landingSurrounding property damageInjury of uninvolved surrounding persons	<ul style="list-style-type: none">Battery temperature is kept within acceptable limits before and during flight
Battery break down.	<ul style="list-style-type: none">Surrounding property damageInjury of uninvolved surrounding persons	<ul style="list-style-type: none">Avoid overflying people and sensitive areasBattery maintenance and correct use

Excess of obstacle avoidance limitations

Safety risk	Possible effects/ consequences	Mitigations
Moving objects or dynamic objects in flying area.	<ul style="list-style-type: none">Property damageInjury of involved person	<ul style="list-style-type: none">Flying area isolated of potential dynamic objects coming in and moving in or in flying areaUse geofence to prevent overflying potentially hazardous areasBe ready to take over manual control and move BLK2FLY away from obstacle
Unrecognised obstacle, not detected by sensors, for example cables < 5 mm	<ul style="list-style-type: none">Property damageInjury of uninvolved surrounding persons	<ul style="list-style-type: none">Area is checked for any potential objects which can exceed sensor limitationsArea isolated from uninvolved persons

Bird strike

Safety risk	Possible effects/ consequences	Mitigations
Bird flock.		<ul style="list-style-type: none">Abort flying if increased bird activity is noticedTake over manual control to avoid collision

Loss of control. Visual navigation failure

Safety risk	Possible effects/ consequences	Mitigations
Overflying reflective surfaces, moving objects.	<ul style="list-style-type: none"> Property damage Injury of uninjured surrounding persons Collision with surrounding objects or people Lose position control due to lack of stable visual ground information 	<ul style="list-style-type: none"> Avoid overflying reflective surfaces, moving objects Do not overfly/fly near people or sensitive (fragile) property Use flight termination button when safe to do so Change to manual mode and land BLK2FLY manually Do not fly in dark environments

Automatic navigation failure

Safety risk	Possible effects/ consequences	Mitigations
Flying with disabled obstacle avoidance close to objects. Only possible in manual mode).	<ul style="list-style-type: none"> Property damage Injury of uninjured surrounding persons 	<ul style="list-style-type: none"> When flying in manual mode, always have obstacle avoidance turned on In automatic mode, obstacle avoidance is always enabled automatically
Plan a surface scan without enough LiDAR measurements of the surface.	<ul style="list-style-type: none"> Flight path is not computed correctly If obstacle avoidance is turned off, it could lead to a collision 	Check in 3D View while hovering in front of the facade for > 2 sec before planning the surface scan.
Flying with obstacle avoidance turned off, close to objects.	<ul style="list-style-type: none"> Property damage Injury of uninjured surrounding persons 	Always have obstacle avoidance turned on.
Switch to Altitude mode control and slowly drifting.	<ul style="list-style-type: none"> Property damage Intrusion of restricted area 	<ul style="list-style-type: none"> Be able to control aircraft in manual Altitude mode Use flight termination button when safe to do so

Take-off failure

Safety risk	Possible effects/ consequences	Mitigations
Flying w/o GNSS pos	Without GNSS pos, obstacle avoidance isn't working.	This is no usecase. Flying w/o GNSS is not supported.
BLK2FLY crash landing after take-off.	<ul style="list-style-type: none"> • BLK2FLY crash landing after take-off • Injury of unin- volved/ involved sur- rounding per- sons 	<ul style="list-style-type: none"> • Area around take-off within 4 m radius point is free of any involved/ unin- volved people and objects • Take-off only from suit- able area
Not detected broken propeller or engine.	<ul style="list-style-type: none"> • Property dam- age • Injury of unin- volved/ involved sur- rounding per- sons 	<ul style="list-style-type: none"> • On time maintenance • Pre flight checks and procedures • Avoid overflying people and sensitive areas
Hardware failure of the BLK2FLY. For example engine breakdown.	<ul style="list-style-type: none"> • Property dam- age • Injury of unin- volved/ involved sur- rounding per- sons 	<ul style="list-style-type: none"> • On time maintenance • Pre flight checks and procedures • Avoid overflying people and sensitive areas

RTH autoland landing failure

Safety risk	Possible effects/ consequences	Mitigations
People or objects moved into landing area.	<ul style="list-style-type: none"> • Property dam- age • Injury of unin- volved/ involved sur- rounding per- sons 	<ul style="list-style-type: none"> • Area is clear of people and objects within 4 m of take-off area
Changing the landing position from return to launch to return to pilot without carefully checking the landing area.		<ul style="list-style-type: none"> • Use nudging to adjust landing position • Take over manual control and adjust position before landing

Obstacle on the RTH path

Safety risk	Possible effects/ consequences	Mitigations
Landing in unsafe locations.	<ul style="list-style-type: none">Property damageInjury of uninjured/involved surrounding persons	<ul style="list-style-type: none">Check the environment of measured objectMonitor RTH and be able to take over at any timeAlways fly with obstacle avoidance activatedIf a high number of obstacles is expected on RTH trajectory, manually execute RTH in advance.

Airframe integrity failure

Safety risk	Possible effects/ consequences	Mitigations
BLK2FLY crashing due evolving damage of airframe.	<ul style="list-style-type: none">Property damageInjury of uninjured/involved surrounding persons	<ul style="list-style-type: none">On time maintenancePre flight checks and proceduresAvoid overflying people and sensitive areas

Excess of environmental limits

Safety risk	Possible effects/ consequences	Mitigations
Flying in rain or starting rain during a flight.	<ul style="list-style-type: none">Property damageInjury of uninjured/involved surrounding personsPossible crash of BLK2FLY	<ul style="list-style-type: none">Do not use the BLK2FLY in rainImmediately land BLK2FLY when rain is incipienting

Environmental conditions

Safety risk	Possible effects/ consequences	Mitigations
Flying at too high wind speeds.	<ul style="list-style-type: none">• Slow drift away from desired location• Collision with potential property damage or injury of surrounding persons	<ul style="list-style-type: none">• Avoid flying beyond set wind limitations• If increased instability of BLK2FLY is noticed, abort/postpone flying until conditions normalised

DRAFT

7

Description of the Application, Mission Planning

7.1

Start Up Screens

Description

The following step table gives an overview on starting the BLK2FLY Live app. Moreover, it shows which menus appear.

1. Start the BLK2FLY Live app from the tablet.



2. Pairing between the BLK2FLY and the BLK2FLY Live app.
☞ Refer to [7.2 Pairing](#) for a detailed description.



CONNECTED appears after successful connection.

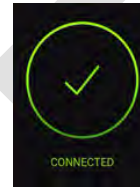

3. The menu **WELCOME** is shown. Refer to the following links for more information:
 - [7.6.4 Project Browser Screen](#)
 - [7.6.5 AIRSPACE INFORMATION Screen](#)
 - [7.6.1 Live View Screen](#)
 - [User Manual](#)

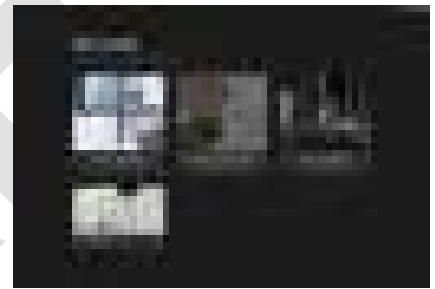

4. Tap on one of the main menus or open the hamburger menu on the top left for more options. Refer to [7.6 Hamburger Menu](#) for more details.

7.2

Pairing

Menu Pairing



After log in the Apple iPad must connect with the BLK2FLY for communication. There are two options:

- Connection to the BLK2FLY happens for the first time: Pairing task starts. Refer to [Pairing BLK2FLY with BLK2FLY Live app](#) to follow the step-by-step description.
- Connection between Apple iPad and BLK2FLY was established before: The app BLK2FLY Live tries to connect to already known devices. Refer to [Pairing again to known devices](#) for details.

Pairing BLK2FLY with BLK2FLY Live app

1. Install the BLK2FLY Live app. Accept all preconditions like allowing Bluetooth or iPad location.
2. Put a charged battery into BLK2FLY.
3. Tap and hold the power button until the LED colour ring and battery LED start blinking blue.
4. Start the BLK2FLY Live app.

5. The app searches for BLK2FLY devices which are currently in pairing mode. After a few seconds, it jumps to the next screen.

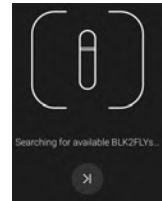

 Do not tap . Otherwise the search is aborted.



6. Listed are all detected BLK2FLY which are currently in pairing mode. But BLK2FLY Live app will automatically connect to the BLK2FLY that was used the last time if available.



 To change to a different BLK2FLY, repeat the pairing process.

 If no BLK2FLY appears in the list, make sure BLK2FLY is in pairing mode (blue light). Tap  to repeat the search.

7. Tap on the desired BLK2FLY device in the list.

8. Join the network of the selected BLK2FLY.

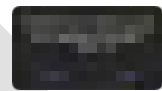

9. Wait until pairing is successful. BLK2FLY is now ready to be used.



 After this procedure, the app knows the credentials of the paired BLK2FLY. If the app is closed and restarted, it tries to connect automatically to the paired BLK2FLY. For successful connection, BLK2FLY must be turned on.

Pairing again to known devices

After successful **LOGIN**, the pairing starts.

1. The Apple iPad is connecting with the BLK2FLY.

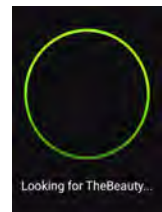

2. The Apple iPad is connected with the BLK2FLY.



 After successful pairing, the **WELCOME** menu automatically opens. Refer to [7.3 Menu WELCOME](#) for details.

 Communication between BLK2FLY and Apple iPad is only enabled once the pairing is successful completed.

7.3

Menu WELCOME

Description

After successful **LOGIN** and pairing with the BLK2FLY the menu **WELCOME** is shown.

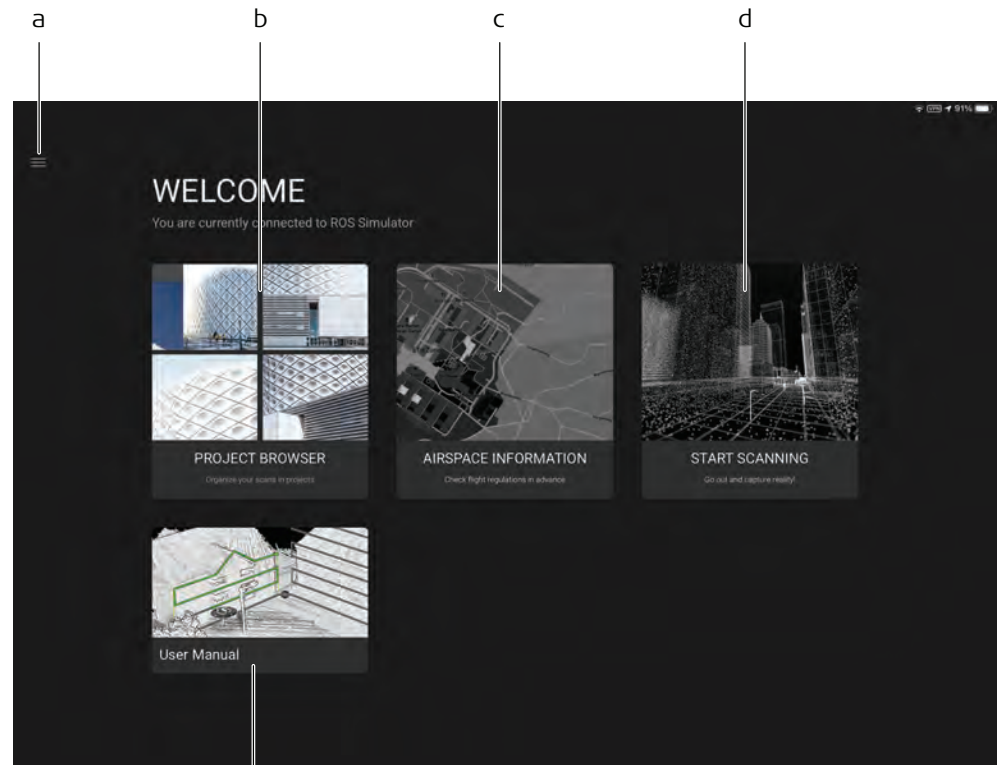

- a Hamburger menu. Refer to 7.6 Hamburger Menu for details
- b **PROJECT BROWSER:**
Open this menu optionally direct from the hamburger menu.
Refer to 7.6.4 Project Browser Screen for details
- c **AIRSPACE INFORMATION:**
Open this menu optionally direct from the hamburger menu.
Refer to 7.6.5 AIRSPACE INFORMATION Screen for details
- d **Start Scanning:**
Open this menu optionally direct from the hamburger menu.
Refer to 7.6.1 Live View Screen for details
- e **User Manual:**
Tap to open the digital version of the BLK2FLY User Manual. Search functionality given

7.4

Status Bar

Description

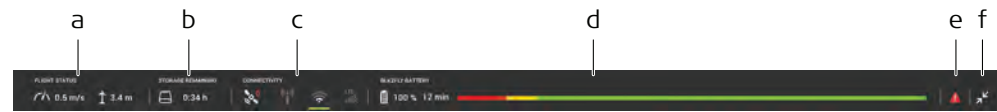

23612.001_en



- | | | | |
|---|-------------------------------|---|---------------------------------------|
| a | FLIGHT STATUS | e | Warning |
| b | STORAGE REMAINING | f | Tap to reduce/maximise the status bar |
| c | CONNECTIVITY status | g | Reduced status bar |
| d | BLK2FLY BATTERY status | | |

Detailed description











Menu	Description
FLIGHT STATUS	Shows ground speed and relative altitude.
STORAGE REMAINING	Data Recording Time. Storage remaining in hh:mm.
CONNECTIVITY	Number of GNSS satellites tracked. WLAN connection signal strength to tablet. LTE network signal strength.
BLK2FLY BATTERY	The bar shows the residual capacity of the battery. As the battery State of Charge (SoC) decreases, the bar becomes shorter. <ul style="list-style-type: none">Green bar used up: A low battery warning is initiated. The aircraft automatically activates RTH due to low battery life.Yellow bar is used up: A critical battery warning is initiated. The aircraft lands in its current position. Pilot can control horizontal position and yaw.
Warning	Summary of all given and past notifications and flight restrictions.

7.5











Icons



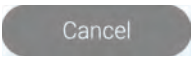









Description













Use this list of icons for reference when operating the software.

Icon	Description
	Hamburger menu.
	Off
	On
	Obstacle avoidance turned off. A warning appears before finally turned off.
	Obstacle avoidance activated.
	Timer. Shows the time elapsed when recording.
	Return to launch.
	Land in place.
	Return to user.
	Delete
	Accept

Icon	Description
	Start scan mission.
	Cancel
	Exit
	Next
	Repeat search for UAV while pairing.
	The fencing set up is deactivated.
	The fencing set up is activated.
	Warning
	System Warning.
	AIRSPACE INFORMATION.
	

Icon	Description
	Add surface/area to scan.
	
	Emergency off switch.
	Tap the icon to show the slider. If the slider is used, the motors of the BLK2FLY immediately turn off.
	Pause
	Cancel
	Ok
	Live View selected.
	Map 2D View selected.
	3D View selected.
 <small>START</small> Manual Recording	Manual Recording.
 <small>START</small> Surface Recording	Surface Recording.

Icon	Description
	Area Recording.
	
	Centre the UAV in the screen.
	Toggle layer map.
	Restriction info.
	Flight restriction info.
	3D View unlocked.
	3D View locked.
	Set back to default value.
	Edit
	UAV flying speed.
	UAV flying height.
	Storage remaining.

Icon	Description
	Number of satellites connected.
	WLAN - full signal.
	WLAN - half signal.
	WLAN - UAV no signal.
	LTE - full signal.
	LTE - half signal.
	LTE - no signal.
	RTK active.
	RTK inactive.
	RTK active with warning.
	Battery status. Full.
	Connection lost.

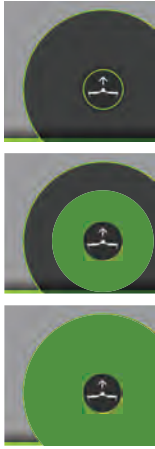
Icon	Description
 <p>The icon column contains three vertically stacked square images. The top image shows a dark grey circular button with a white upward-pointing arrow and a small white drone icon. A hand cursor is positioned over the button. The middle image shows the same button, but it is now highlighted with a bright green circular glow. The bottom image shows the button with a larger, more intense green glow, indicating it is active.</p>	<p>Tap/hold the take-off button for > 3 s. The BLK2FLY starts and hovers at 1 m</p>

DRAFT

7.6

Hamburger Menu

Description

Tap the hamburger icon opens the side menu. The hamburger menu is accessible from every menu. The position is always top/left.

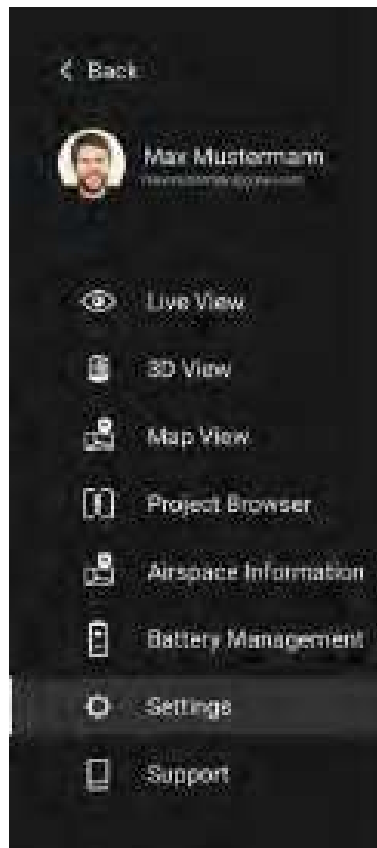

- a **Live View.** Refer to [7.6.1 Live View Screen](#) for more details
- b **3D View.** Refer to [7.6.2 3D View Screen](#) for more details
- c **Map View.** Refer to [7.6.3 Map View Screen](#) for more details
- d **Project Browser.** Refer to [7.6.4 Project Browser Screen](#) for more details
- e **Airspace Information.** Refer to [7.6.5 AIRSPACE INFORMATION Screen](#) for more details
- f **Battery Management.** Refer to [7.6.6 Battery Management Screen](#) for more details
- g **Settings.** Refer to [7.6.7 Settings Screen](#) for more details
- h **Support.** Refer to [7.6.8 Support Screen](#) for more details

Description

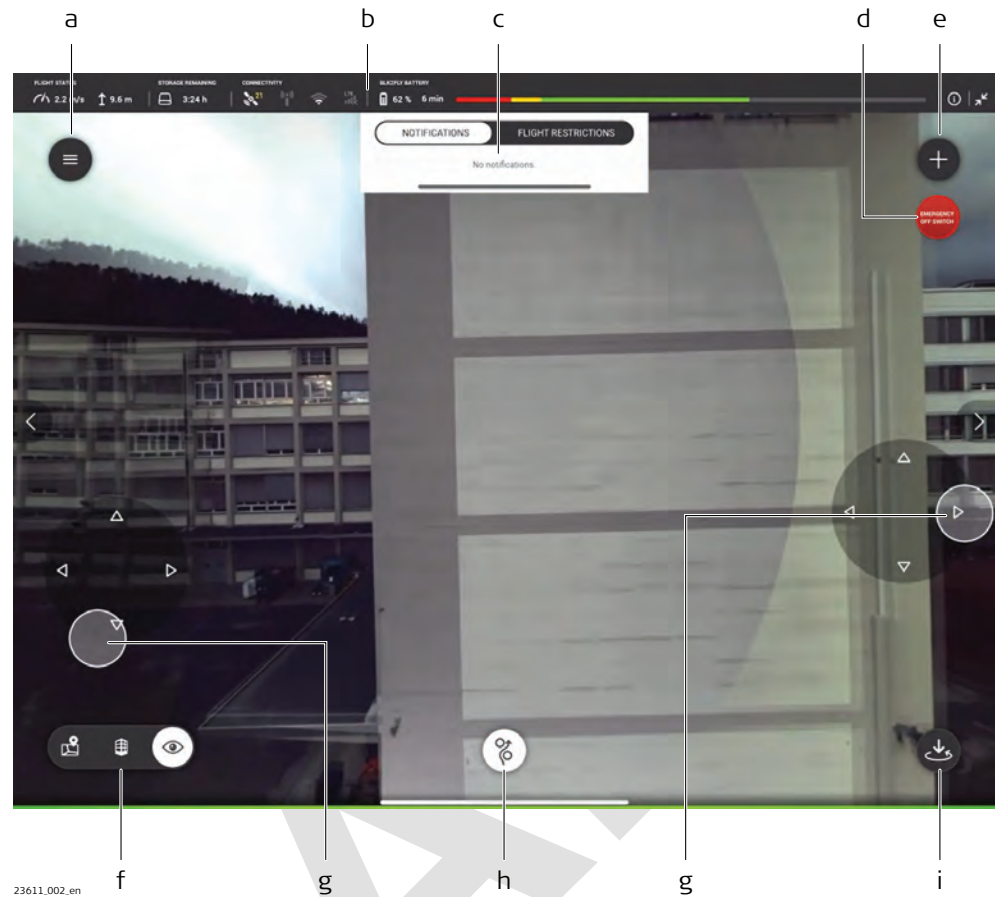

a Hamburger menu. Refer to 7.6 Hamburger Menu for details

b Status bar. Refer to 7.4 Status Bar for details

c **NOTIFICATIONS** and/or **Flight Restrictions**

d **Emergency off switch**

e Tap to open the **ADD A NEW SCAN** menu. Refer to 7.7 Scan Modes for details.

f Toggle between **Map View**, **3D View** and **Live View**

g Joystick control for the BLK2FLY

h Tap to return to launch. Define return behaviour under **Settings** → **Flight** → **Return behaviour**. Refer to 7.6.7.4 Flight Screen for details¹⁾

Options

- Navigate the BLK2FLY
- Show the current live view of the BLK2FLY
- Position the BLK2FLY to have the object of interest in view
- Single tap on the screen to centre the view on the defined point
- Open the **ADD A NEW SCAN** menu
- Manual control the BLK2FLY using the virtual joysticks



Zooming in this view flies the BLK2FLY to a new position to be able to show the area of interest.



Digital zoom is only possible in **3D View**.

¹⁾ By holding the button for 2 sec, it is possible to define the return behavior manually.

Description

This screen shows a visualisation of the onboard map in real-time. This voxelized map does not represent the current data being captured.

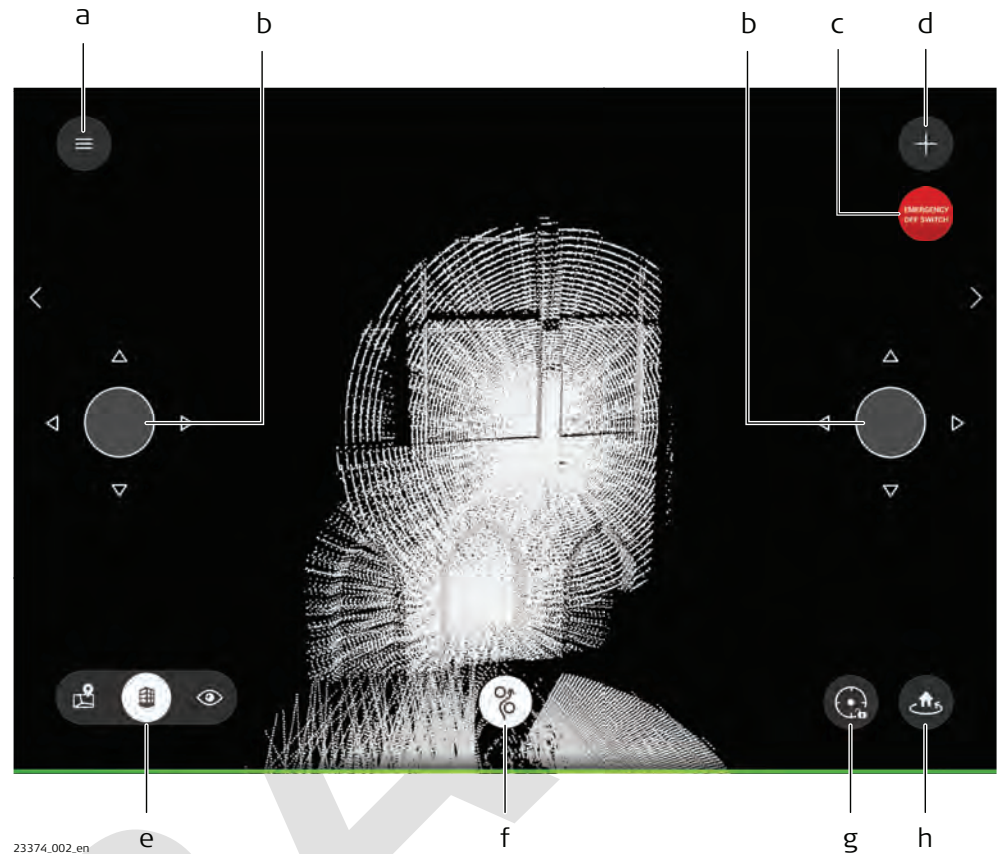

- 23374_002_en
- a Hamburger menu. Refer to 7.6 Hamburger Menu for details
 - b Virtual joysticks
 - c **Emergency off switch**
 - d Tap to open the **ADD A NEW SCAN** menu
 - e Toggle between **Map View**, **3D View** and **Live View**
 - f Obstacle avoidance button
 - g Centre button
 - h Tap to return to launch. Return behaviour can be defined under **Settings** → **Flight** → **Return behaviour**. Refer to 7.6.7.4 Flight Screen for details²⁾

Description of the keys

Menu	Description
Virtual joysticks	Appear when touching the vertical centre at the very left/right edge of the screen.
Obstacle avoidance	Obstacle avoidance can be turned off. A warning appears before finally turned off.

²⁾ By holding the button for 2 sec, it is possible to define the return behavior manually.

Menu	Description
Centre button	<p data-bbox="845 157 1442 189">Centres view on BLK2FLY Live app:</p> <ul data-bbox="845 189 1442 378" style="list-style-type: none"><li data-bbox="845 189 1442 283">• Short tap centres for the current location of BLK2FLY, but won't keep centred on BLK2FLY<li data-bbox="845 283 1442 378">• Long tap, button turns white and view will always centre on the BLK2FLY, even location is changed. <p data-bbox="845 378 1442 457">A longpress again, turns off this behaviour.</p>

DRAFT

7.6.3

Map View Screen

Description

- Easily locate the BLK2FLY on the map
- Show flight advisories and rulesets
- Define a permitted flight area, so called fence. This fence supports the pilot to fly with the BLK2FLY only in the permitted area.

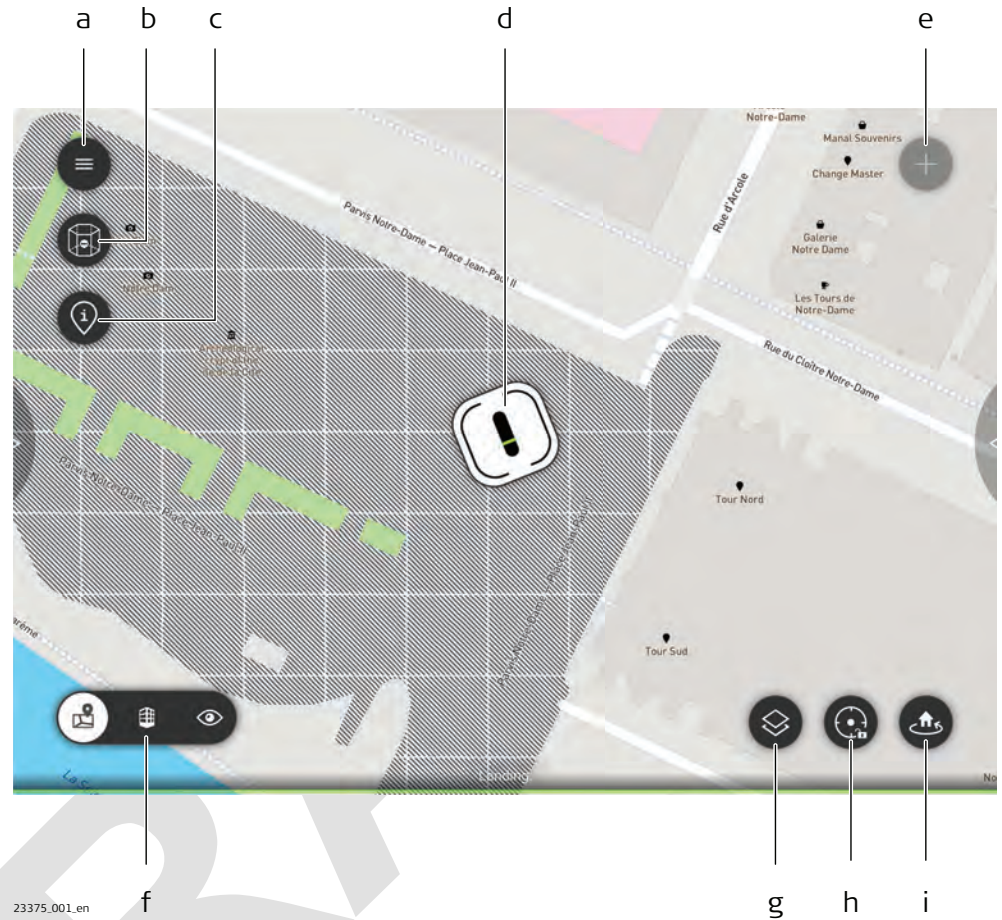

- 23375_001.en
- a Hamburger menu. Refer to 7.6 Hamburger Menu for details
 - b **Fencing** button. Refer to 8.2.2 Fencing for more details
 - c **AIRSPACE INFORMATION** button
 - d Position and orientation of the BLK2FLY
 - e Tap to open the **ADD A NEW SCAN** menu
 - f Toggle between **Map View**, **3D View** and **Live View**
 - g **Map type** button
 - h **View Center** button
 - i Tap to return to launch. Return behaviour can be defined under **Settings** → **Flight** → **Return behaviour**. Refer to 7.6 Hamburger Menu for details

7.6.4

Project Browser Screen

Description

Open this screen optionally direct from the menu **WELCOME**. Use this screen to manage projects.

PROJECTS screen



23361_001_en

- a Hamburger menu. Refer to 7.6 Hamburger Menu for details
- b Add new project to the existing project list
- c Given projects. Active project is highlighted.
- d Adds new scan to the active project
- e Edit the name of the project. Example: TEST18032021
- f Delete the selected project. Example: TEST18032021
- g Scans and collections
- h Select sorting criteria for given scans. Either by time or name

Description

- **ADVISORIES:** Rulesets for current airspace
- **RULESETS:** Rulesets for the country where flying the BLK2FLY



AIRSPACE INFORMATION can be checked in the **Map View** or in the **AIRSPACE INFORMATION** screen.

Flight restrictions on location

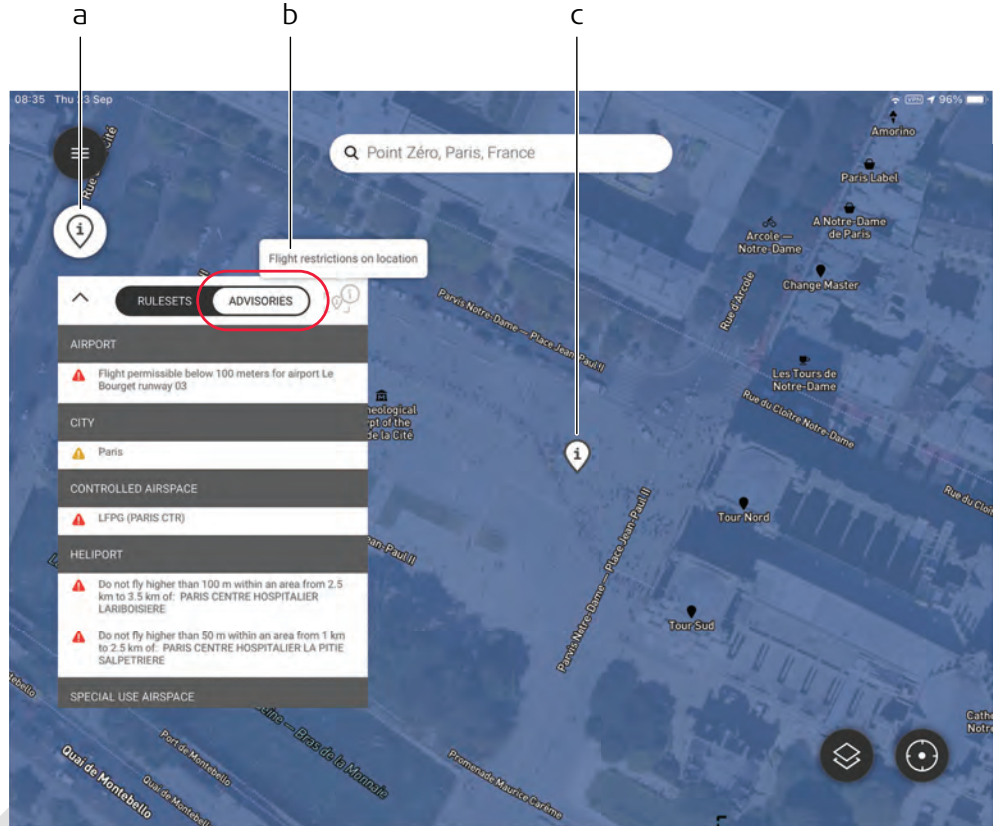

23376.001.en

- AIRSPACE INFORMATION. Tap, to show/hide the restrictions overlay. As well valid for official no-fly zones.
- Help text for active selection on overlay.
- Location, where the advisories and rule sets are valid for.

Flight restrictions on map

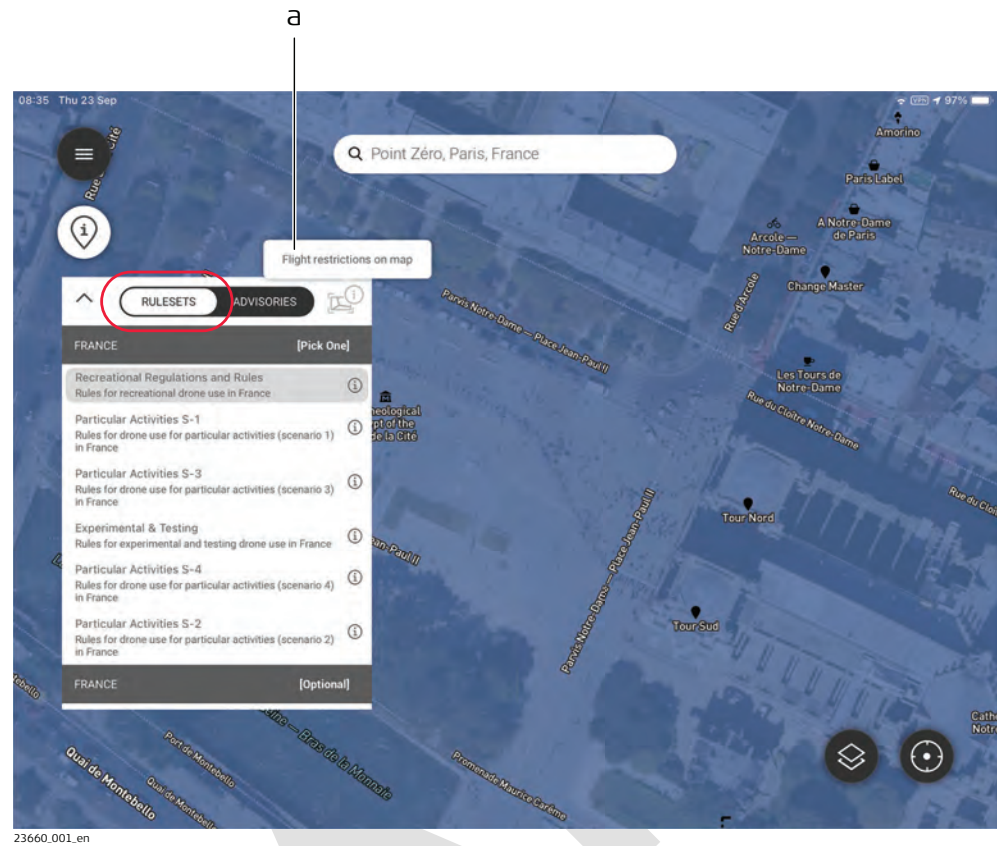

a Help text for active selection on overlay.

Description

This screen gives an overview of the Smart Battery GEB374 installed in the BLK2FLY.

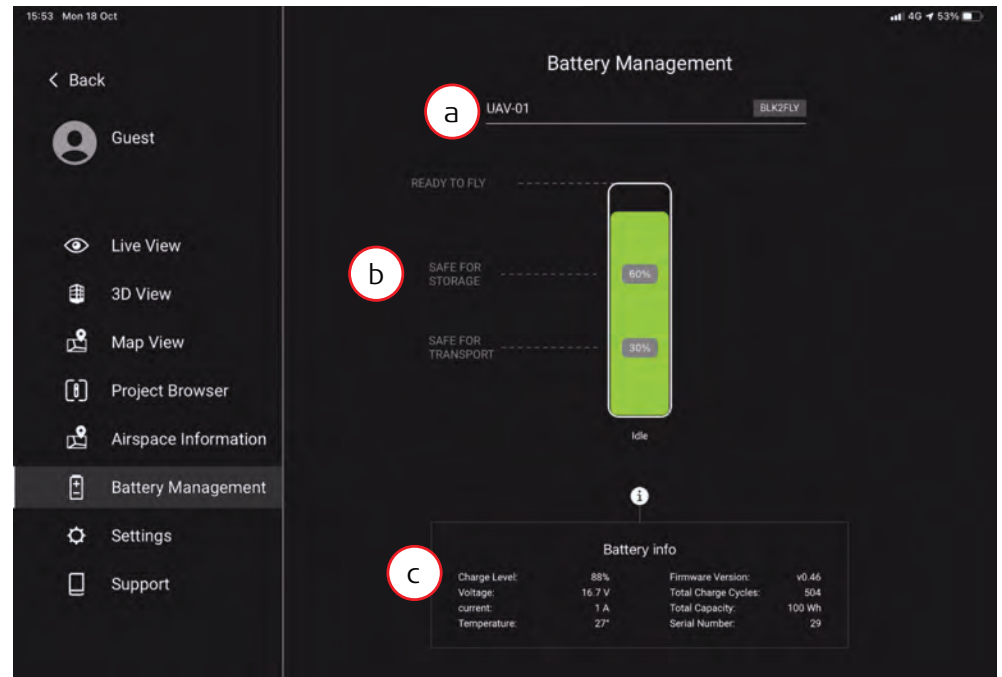

- a Name of the BLK2FLY
 b Predefined charge levels for reference

c **Battery info**

Detailed description

Type	Description
Predefined charge levels for reference	<ul style="list-style-type: none"> • READY \nTO FLY = 100% • SAFE FOR \nSTORAGE = 60% • SAFE FOR \nTRANSPORT = 30%
Battery info	Current information on the battery

Description

Use this screen to check/set up settings of the BLK2FLY Live app and BLK2FLY.

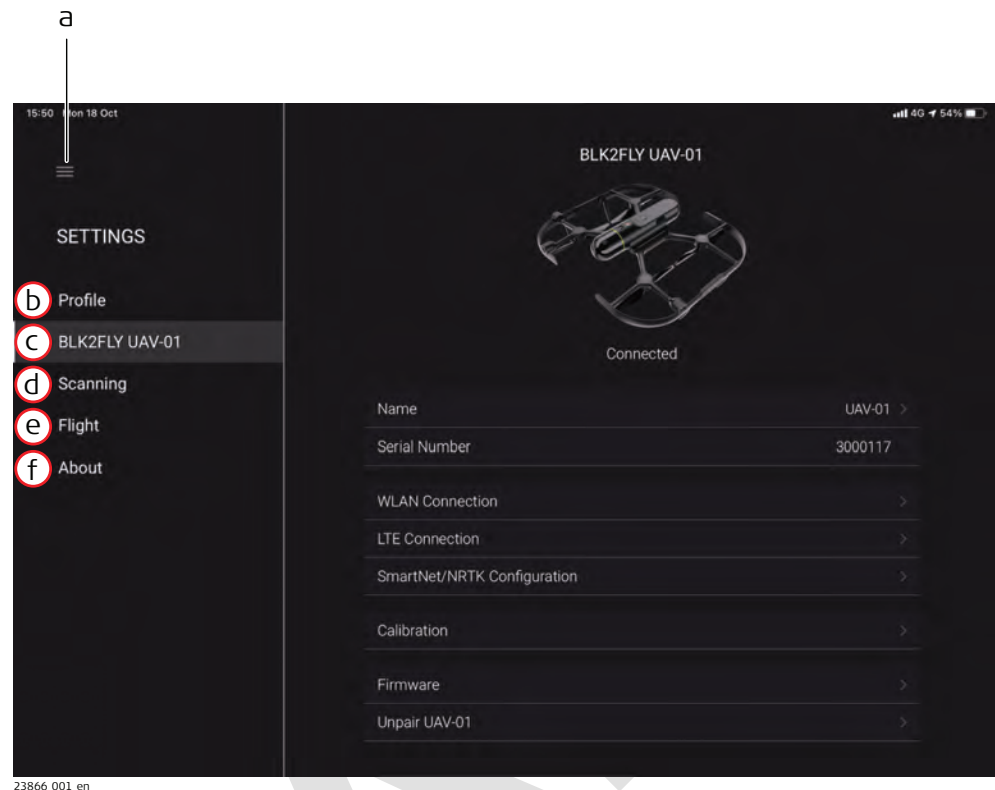

- a Hamburger menu. Refer to [7.6 Hamburger Menu](#) for details
 b Profile
 c Name

- d Scanning
 e Flight
 f About

Detailed description

Type	Description
Profile	Refer to 7.6.7.1 Profile Screen for details.
Name	Refer to 7.6.7.2 BLK2FLY Screen for details.
Scanning	Refer to 7.6.7.3 Scanning Screen for details.
Flight	Refer to 7.6.7.4 Flight Screen for details.
About	Information on used open source libraries.

7.6.7.1

Profile Screen

Description

Use this screen to manage the profile of the current logged on operator.

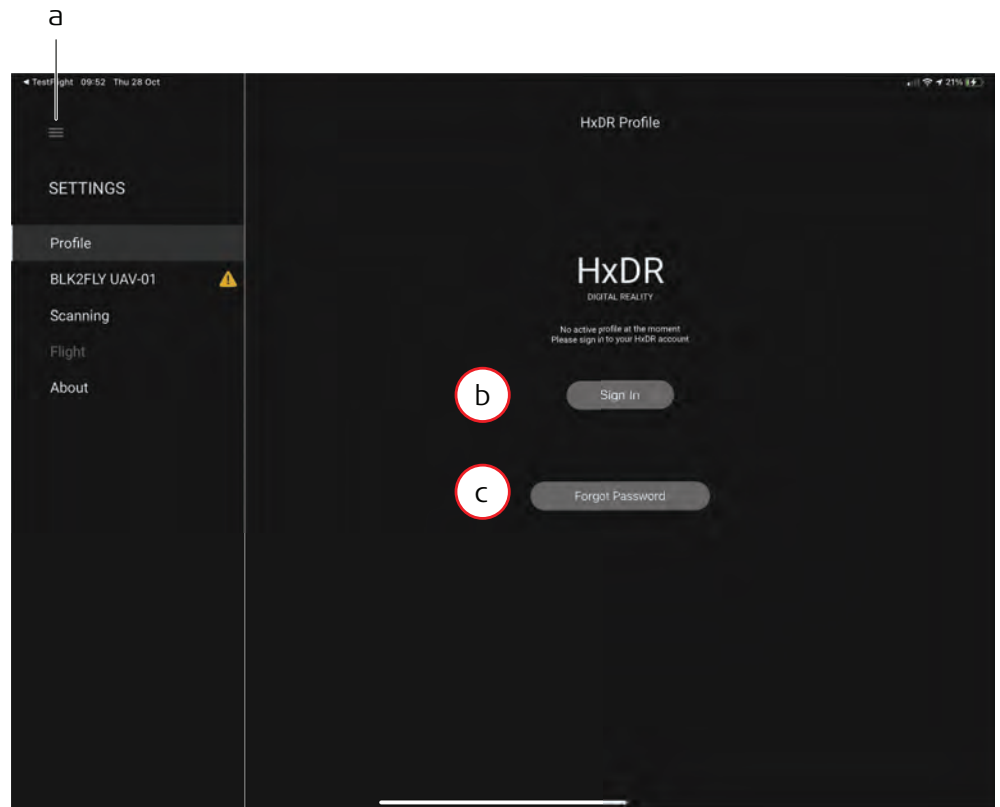

a Hamburger menu. Refer to 7.6 Hamburger Menu for details

b **Sign In**
c **Forgot Password**

Detailed description

Type	Description
Sign In	Sign in to HxDR Leica Geosystems network. Refer to Sign In entry mask for details.
Forgot Password	Redirect to webpage hxdn.app/pw-recovery to request new password.

Sign In entry mask

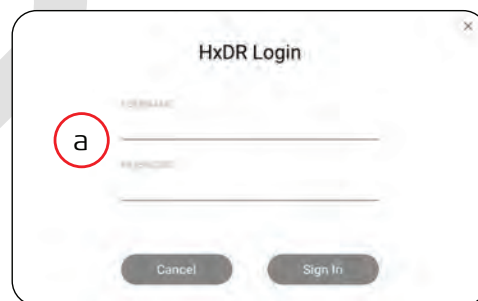

a Username and password to log in

Description

Use this screen to configure, calibrate and update the BLK2FLY.

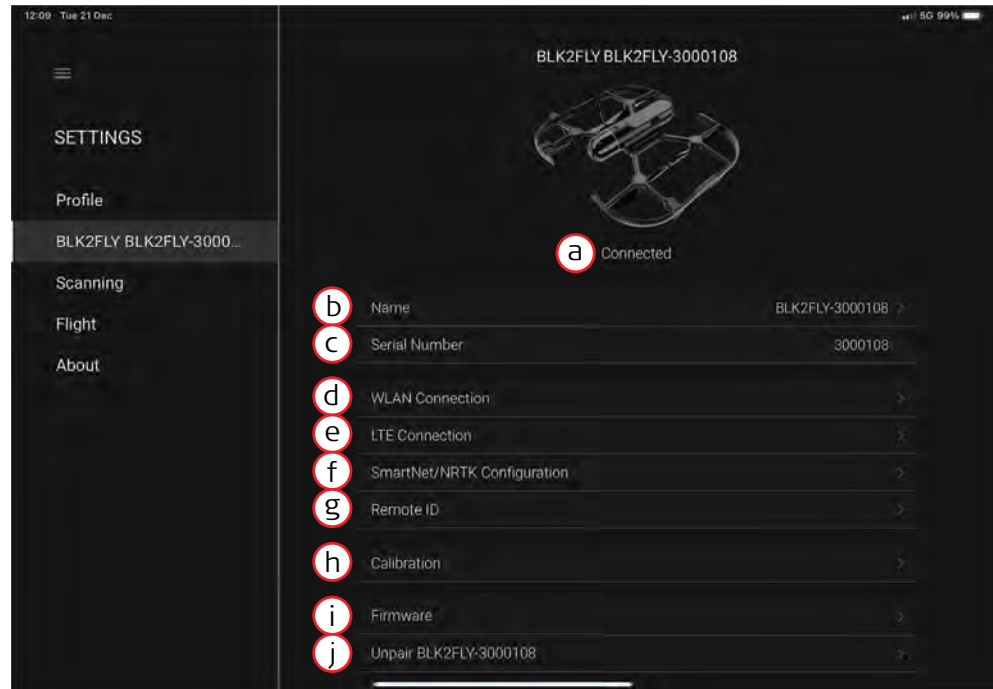

23389_002_en

a	BLK2FLY connection status	f	SmartNet/NRTK Configuration
b	Name	g	Remote ID
c	serial number	h	Calibration
d	WLAN Connection	i	Firmware
e	LTE Connection	j	Unpair

Detailed description

Type	Description
BLK2FLY connection status	<ul style="list-style-type: none"> Connected Not connected Searching
Name	Menu to edit the name of the BLK2FLY.
serial number	Displays the serial number of the BLK2FLY.
WLAN Connection	Tap to configure WLAN connection for data transfer. Refer to BLK2FLY WLAN Connection screen for details.
LTE Connection	Tap to configure LTE connection. Refer to BLK2FLY LTE Connection screen for details.
SmartNet/NRTK Configuration	Tap to configure access for the NRTK provider. Refer to SmartNet/NRTK Configuration screen for details.
Remote ID	Tap to edit the operator number. Refer to Remote ID screen for details.
Calibration	Tap to calibrate the compass. Refert to 10.4 Compass Calibration for details.

Type	Description
Firmware	Tap to check: <ul style="list-style-type: none"> • Current firmware installed on BLK2FLY • Latest available firmware • Smart Battery firmware Refer to Firmware screen for details.
Unpair	Unpair the BLK2FLY from the Apple iPad for pairing with a different BLK2FLY.

BLK2FLY WLAN Connection screen

Use this screen to select/connect to the BLK2FLY using WLAN.
 The WLAN connection is used for data transfer using Leica Cyclone REGISTER 360 or uploading to HxDR.

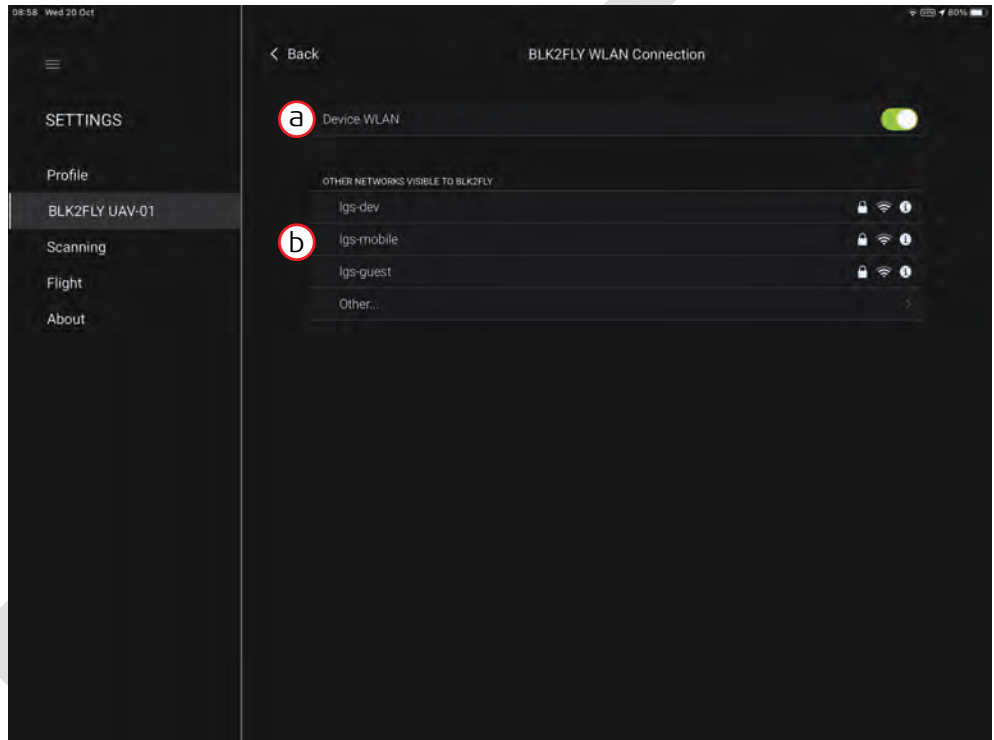

a Device WLAN

b List of networks visible to BLK2FLY

Detailed description

Type	Description
Device WLAN	Enable/disable WLAN connectivity.
Visible networks	Choose the network to connect with the BLK2FLY.

BLK2FLY LTE Connection screen

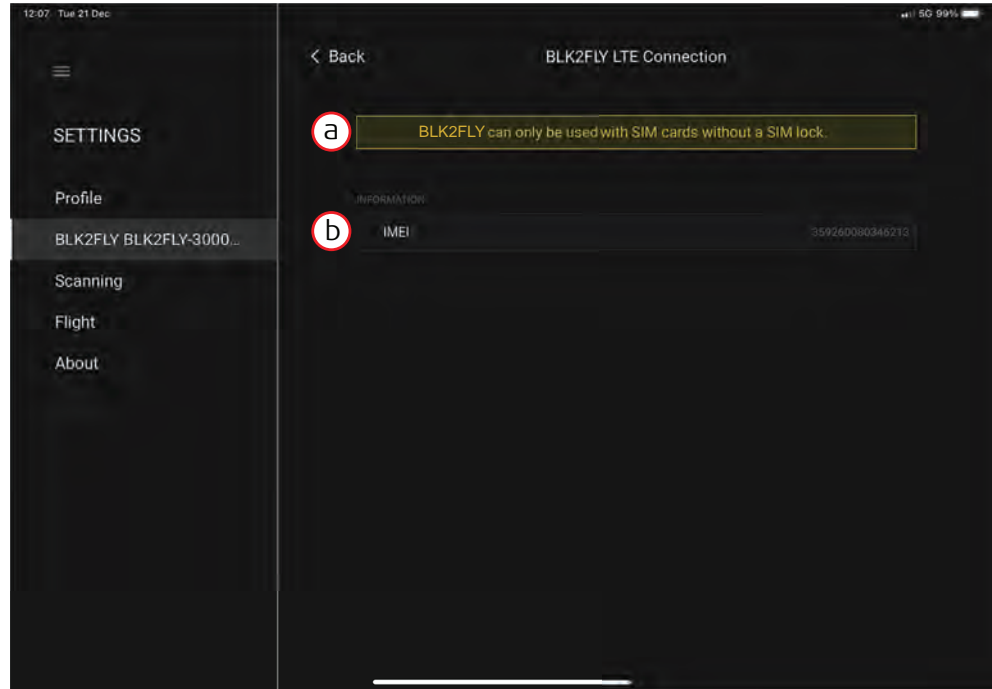

23892_002_en

a Information message

b IMEI number

Detailed description

Type	Description
SIM card	This menu highlights that a SIM card must not have a SIM lock. Remove SIM lock by using for example a mobile phone before usage with BLK2FLY.
IMEI	<p>The IMEI number, International Mobile Equipment Identity, is a unique 15-digit code. It precisely identifies the device with the SIM card input. The GSM Association organisation defines the first 14 digits. An algorithm named Luhn formula generates the last digit. It is a control character. This whole number is an individual number assigned to each and every mobile device all over the world.</p> <p>As the SIM card number cannot be a permanent identifier of the device, the IMEI was created. The SIM card is associated with the user. It can be easily transferred from the mobile to another mobile.</p>

SmartNet/NRTK Configuration screen

Use this menu to configure the Network configuration.

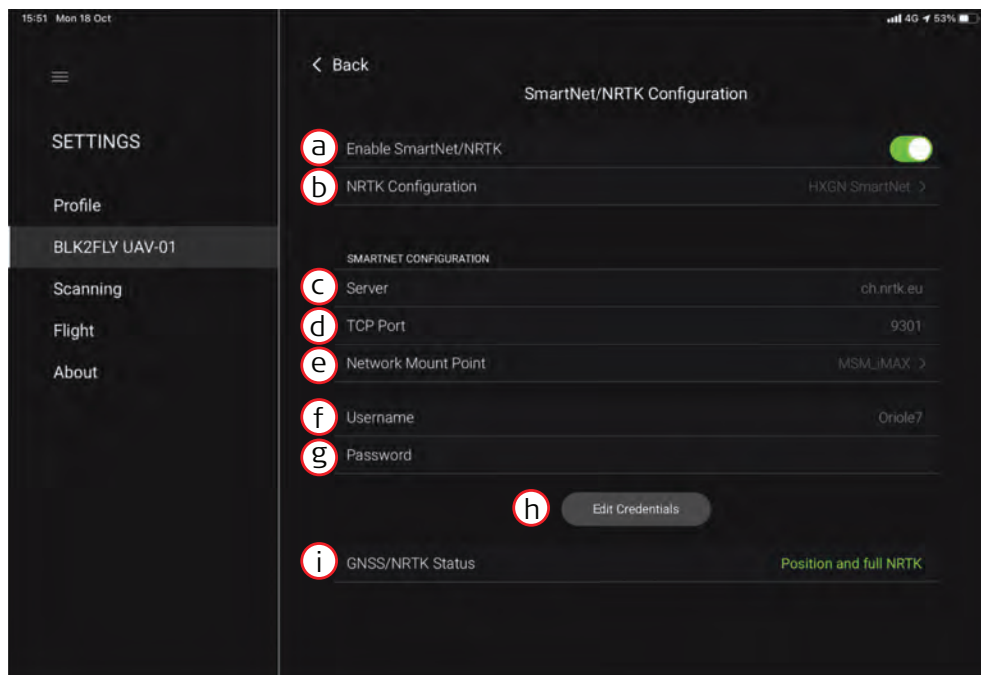

23391.001.en

- | | | | |
|---|-----------------------------|---|-------------------------|
| a | Enable SmartNet/NRTK | f | Username |
| b | NRTK Configuration | g | Password |
| c | Server | h | Edit Credentials |
| d | TCP Port | i | GNSS/NRTK Status |
| e | Network Mount Point | | |

Detailed description

Type	Description
Enable SmartNet/NRTK	Tap to enable/disable SmartNet/NRTK.
NRTK Configuration	Tap and choose the NRTK Configuration Mode from the list.
Server	Tap to enter the server host address.
TCP Port	Tap to enter the TCP Port .
Network Mount Point	Tap to enter Network Mount Point name.
Username	Active username provided by the NRTK service provider.
Password	Active password provided by the NRTK service provider.
Edit Credentials	Menu to edit/enter username and password for the NRTK service provider.
GNSS/NRTK Status	Displays GNSS position and NRTK status.

Remote ID screen

Use this menu to enter the operator registration number.

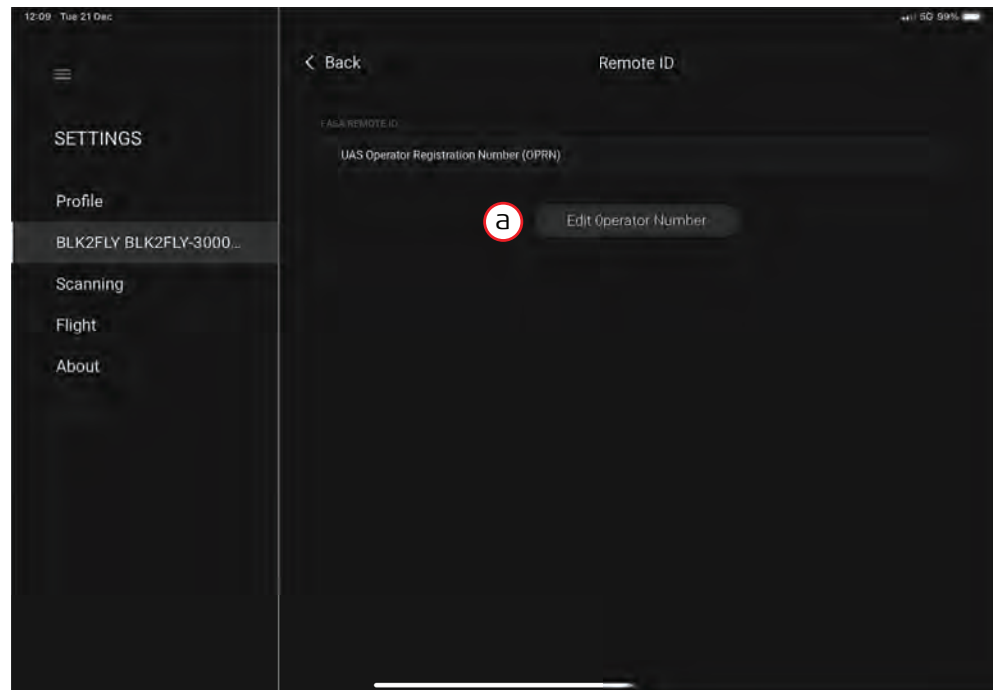

a Edit Operator Number button

Tap Edit Operator Number to open the entry mask.

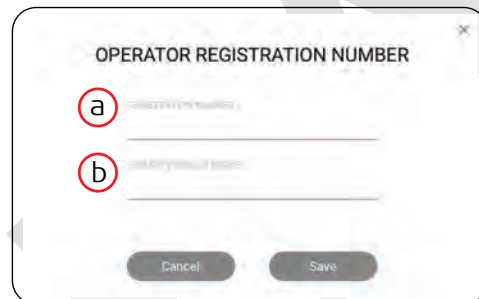

a Registration number

b Security code (3 digits)

Detailed description

Type	Description
Registration number	Enter the registration number.
Security code (3 digits)	Enter the security code – three digits.

Firmware screen

This screen shows the current firmware versions for BLK2FLY and Smart Battery GEB374.

The operator gets informed once new firmware versions are available. Refer to the blue text lines on this screen.

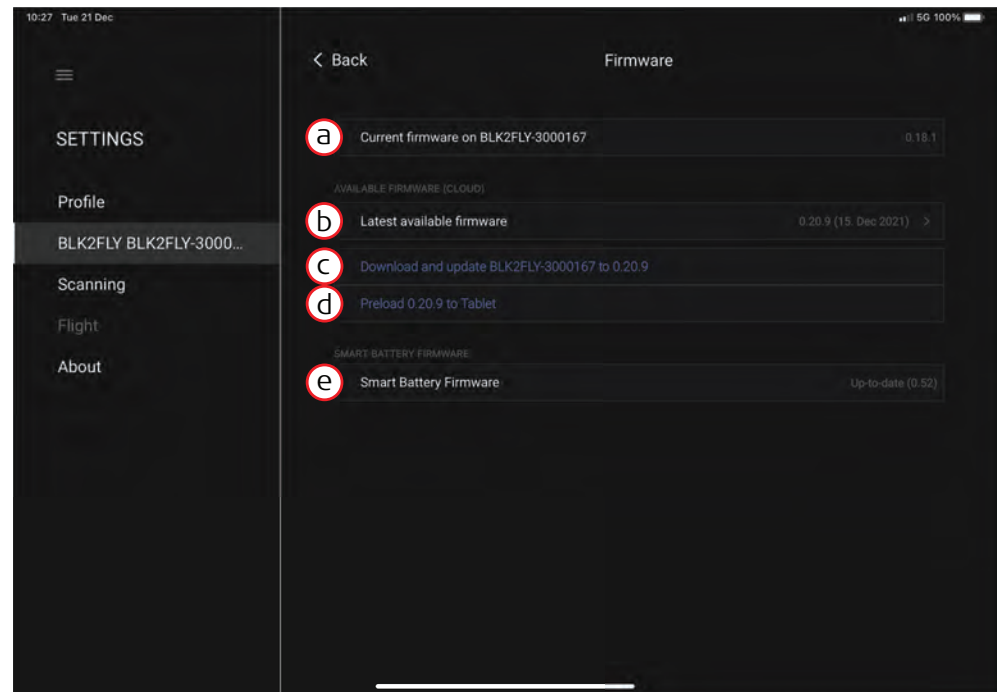

23890_002_en

- a **Current firmware on %@ connected BLK2FLY**
- b **Latest Available Firmware**
- c **Download and update %@ to %@**
- d **Preload %@ to Tablet**
- e **Smart Battery Firmware**

Detailed description

Type	Description
Current firmware on %@	Shows the currently installed firmware version on the BLK2FLY.
Latest Available Firmware	Tap to read the latest release notes.
Download and update %@ to %@	This entry is only visible, once a new firmware is available. Use this option to update the currently paired BLK2FLY.
Preload %@ to Tablet	This entry is only visible, once a new firmware is available. Use this option to have the firmware file available locally on the Apple iPad. This way any BLK2FLY can be updated after pairing with the Apple iPad, even when offline.
Smart Battery Firmware	Shows the status of the current Smart Battery Firmware .

Update the BLK2FLY as follows:

Option 1:

1. Tap **Download and update %@ to %@** directly in this menu.



Attention: Mobile data used for download.
Size of firmware is about 1 GB.

NOTICE

It is highly recommended to have a SIM with unlimited data contract.
Flying using LTE as connection protocol to BLK2FLY, uses mobile data too.

Option 2:

1. Tap **Preload %@ to Tablet** directly in this menu. It downloads the firmware to the Apple iPad.
2. Tap **Done**, after the firmware download is finished.
3. Connect/pair the Apple iPad with the BLK2FLY.
4. Tap **Update %@ to %@** for updating the connected BLK2FLY.

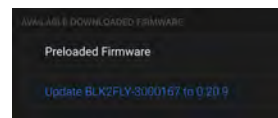
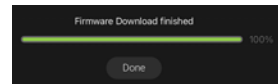

7.6.7.3

Scanning Screen

Description

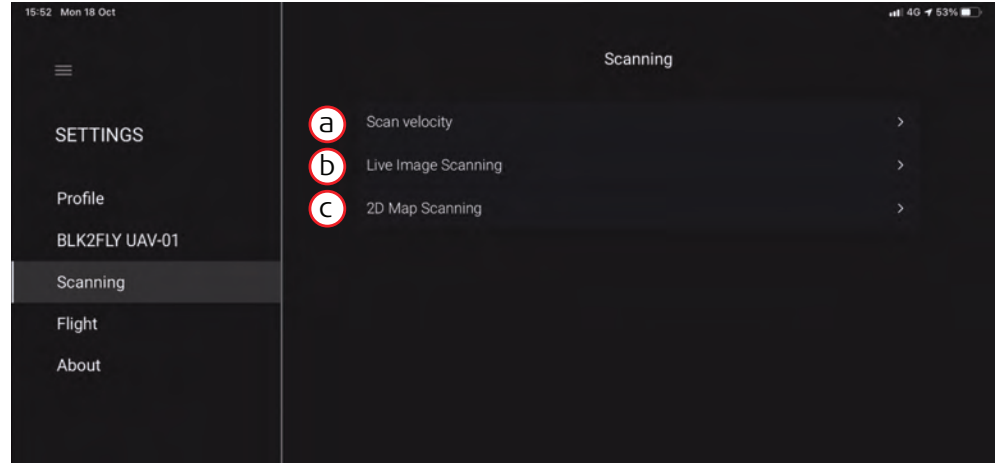

- a Scan velocity
- b Live Image Scanning
- c 2D Map Scanning

Detailed description

Type	Description
Scan velocity	Define flying speed for autonomous scanning. Refer to Scan velocity screen for details.
Live Image Scanning	Define parameters for live image scanning. Refer to Live Image Scanning screen for details.
2D Map Scanning	Define parameters for 2D map scanning. Refer to 2D Map Scanning screen for details.

Scan velocity screen

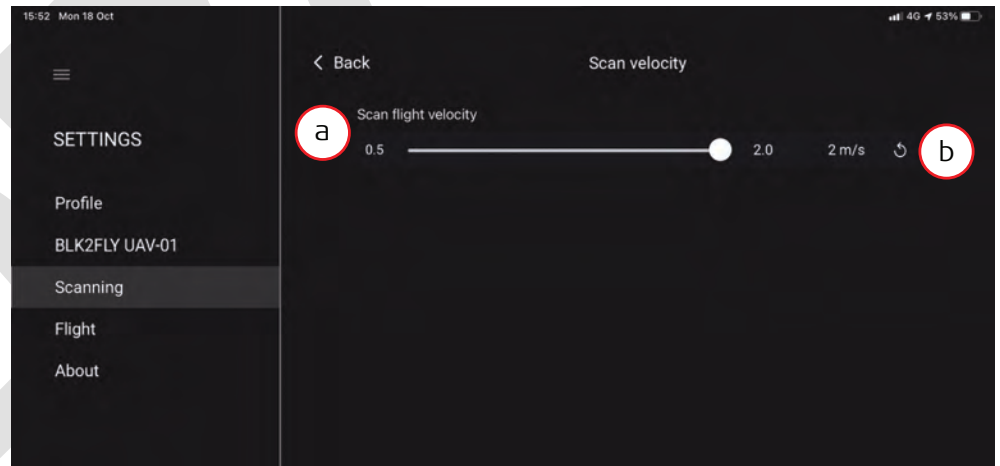

- a Scan flight velocity
- b set back to default value

Detailed description

Type	Description
Scan flight velocity	Define flying speed for autonomous scanning.

Live Image Scanning screen

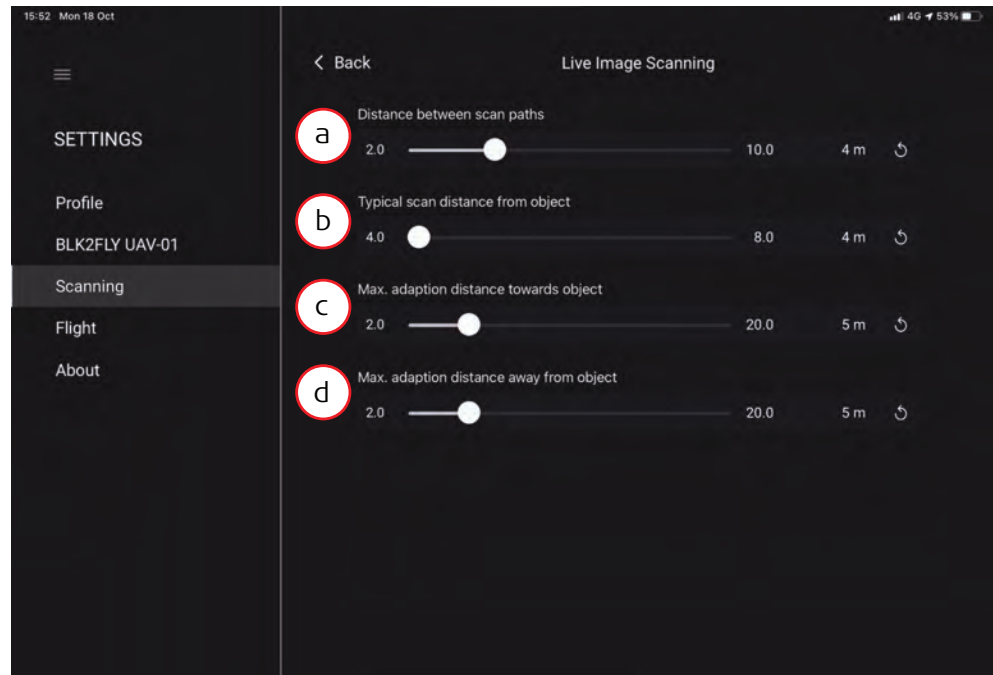

23864_001_en

- a Distance between scan paths
- b Typical scan distance from object
- c Max. adaption distance towards object
- d Max. adaption distance away from object

Detailed description

Type	Description
Distance between scan paths	Defines the distance between scan lines/flight lines. The closer the scan lines are defined, the more dense is the point cloud.
Typical scan distance from object	Distance from object to scan lines.
Max. adaption distance towards object	Maximum adaption distance defines on how much the UAV is allowed to deviate from its original planned path/plane towards the object. For example, if there is a large recess.
Max. adaption distance away from object	Maximum adaption distance defines on how much the UAV is allowed to deviate from its original planned path/plane away from the object. For example, if there is a balcony standing out.

2D Map Scanning screen

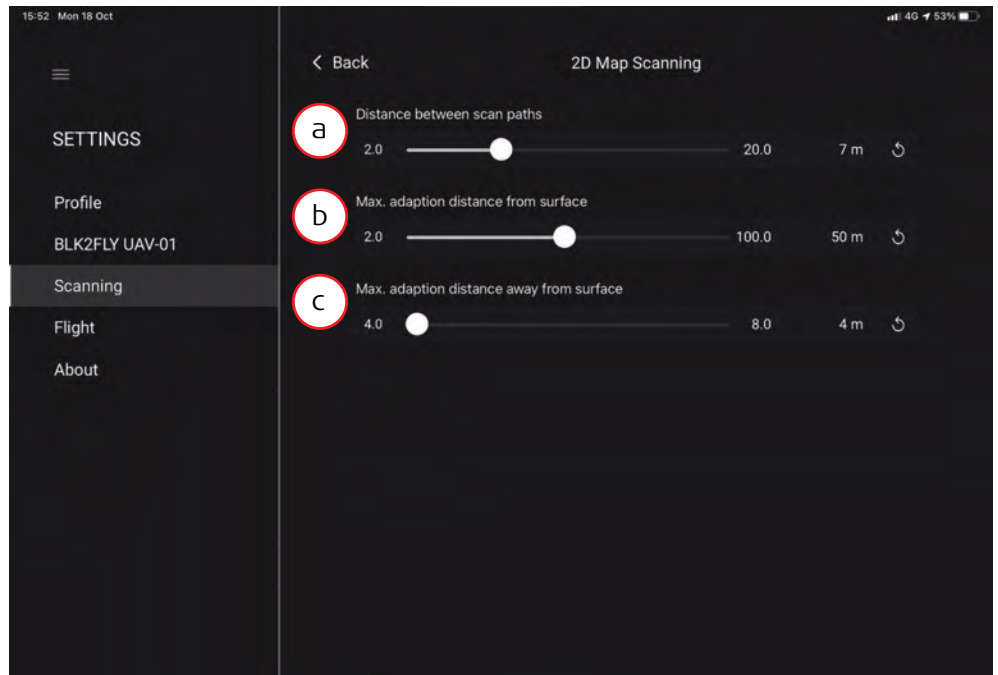

23865_001.en

- a Distance between scan paths
- b Max. adaption distance from surface
- c Max. adaption distance away from surface

Detailed description

Type	Description
Distance between scan paths	Defines the distance between scan lines/flight lines. The closer the scan lines are defined, the more dense is the point cloud.
Max. adaption distance from surface	Maximum adaption distance defines on how much the UAV is allowed to deviate from its original planned path/plane towards the surface. For example, if there is a large whole.
Max. adaption distance away from surface	Maximum adaption distance defines on how much the UAV is allowed to deviate from its original planned path/plane away from the surface. For example, if there is a high building.

Description

Use this screen to manage the profile of the current logged in operator.

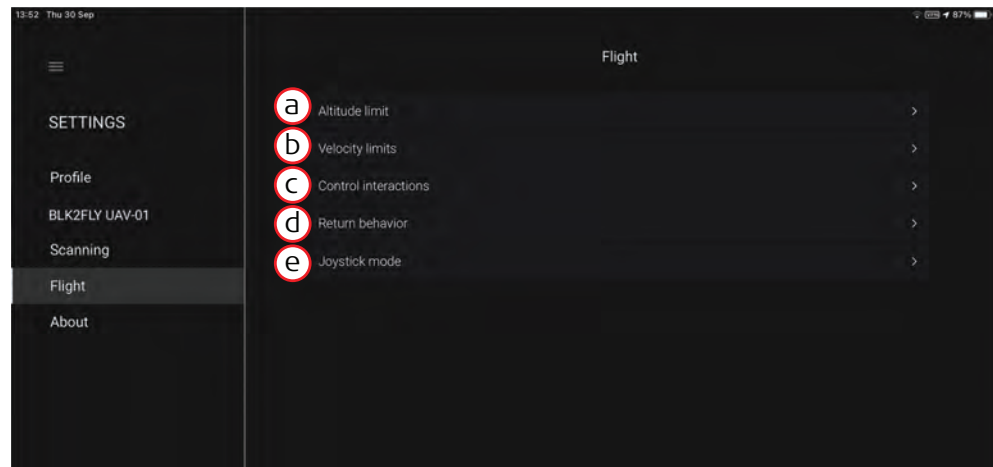

23399_001_en

- | | | | |
|---|-----------------------------|---|-------------------------|
| a | Altitude limit | d | Return behaviour |
| b | Velocity limits | e | Joystick mode |
| c | Control interactions | | |

Detailed description

Type	Description
Altitude limit	Define maximum flight height. Refer to Altitude limit screen for details.
Velocity limits	Define maximum flying speed. Refer to Velocity limits screen for details.
Control interactions	Defines flying distance when double tapping on a certain location in the Live View. Refer to Control interactions screen for details.
Return behaviour	Defines failsafe settings. Refer to Return behaviour screen for details.
Joystick mode	Defines joystick mode. Refer to Joystick mode screen for details.

Altitude limit screen

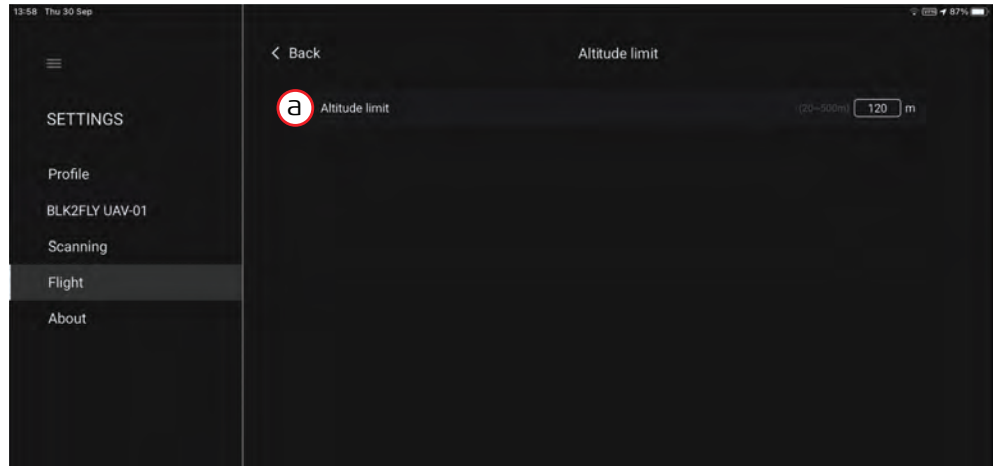

a Altitude limit

Detailed description

Type	Description
Altitude limit	Set the maximum height relative to the home position.

Velocity limits screen

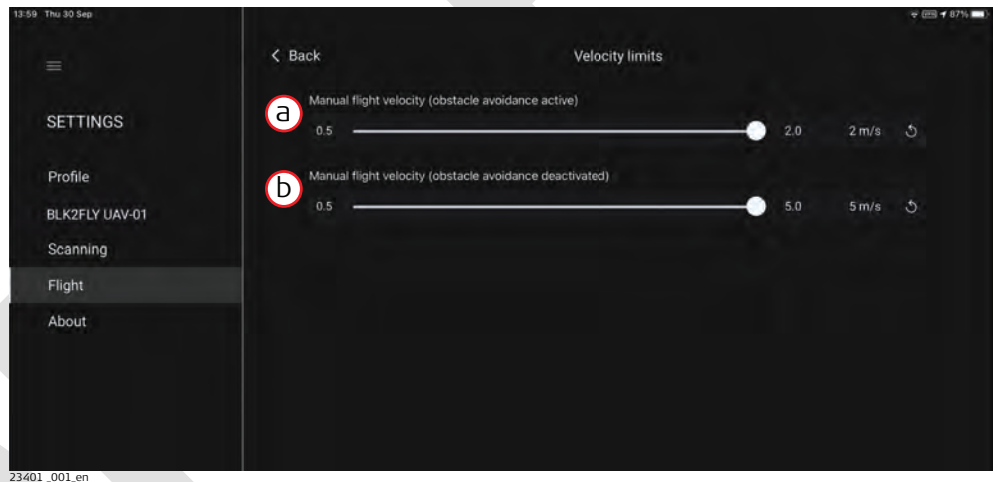

a Manual flight velocity (obstacle avoidance active)

b Manual flight velocity (obstacle avoidance deactivated)

Detailed description

Type	Description
Manual flight velocity (obstacle avoidance active)	Set the maximum flight speed in manual mode when obstacle avoidance is active.
Manual flight velocity (obstacle avoidance deactivated)	Set the maximum flight speed in manual mode when obstacle avoidance is deactivated.

Control interactions screen

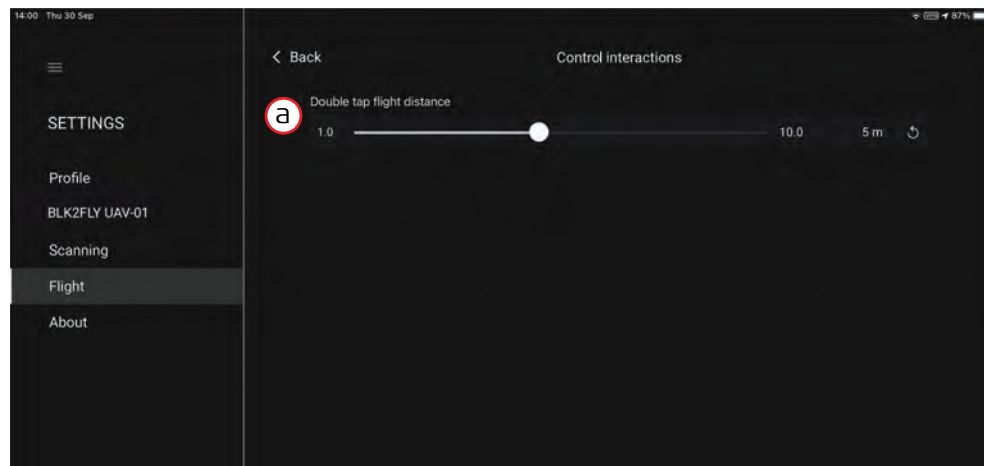

23402_001_en

a Double tap flight distance

Detailed description

Type	Description
Double tap flight distance	To set the distance the BLK2FLY is flying in direction of the double tap when being in the Live View .

Return behaviour screen

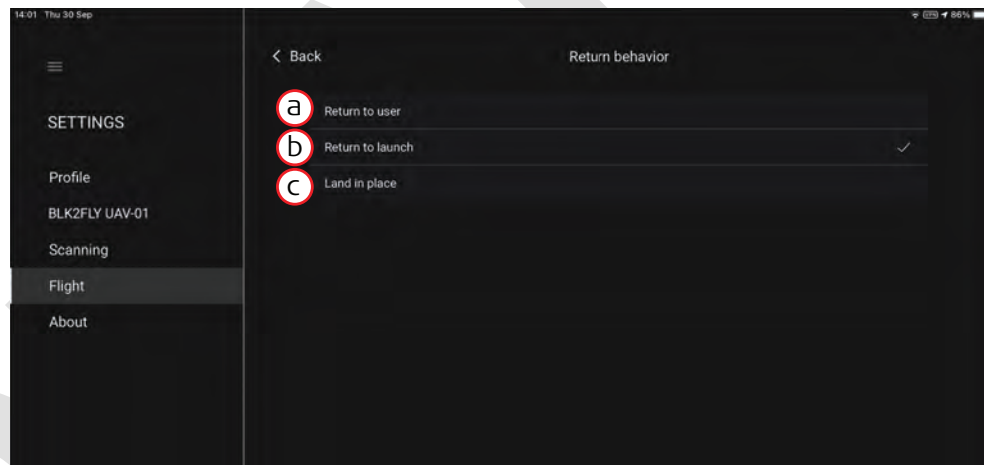



23403_001_en

a Return to user
b Return to launch

c Land in place

Detailed description

Type	Description
Return to user	Sets the position of the Apple iPad as the return point when tapping the home button while flying.  Use Return to user with caution. Due to Apple iPad position inaccuracy, UAV landing spot may be inaccurate. Be ready to take-over manual control.
Return to launch	Sets the launch position as the return point when tapping the home button while flying.

Type	Description
Land in place	BLK2FLY lands in place, current position, when tapping the home button while flying.  Be aware, that the BLK2FLY is landing wherever it currently is.

 There is no setting for minimum height to return to home. The BLK2FLY always flies directly to the defined return location using obstacle avoidance.

Joystick mode screen

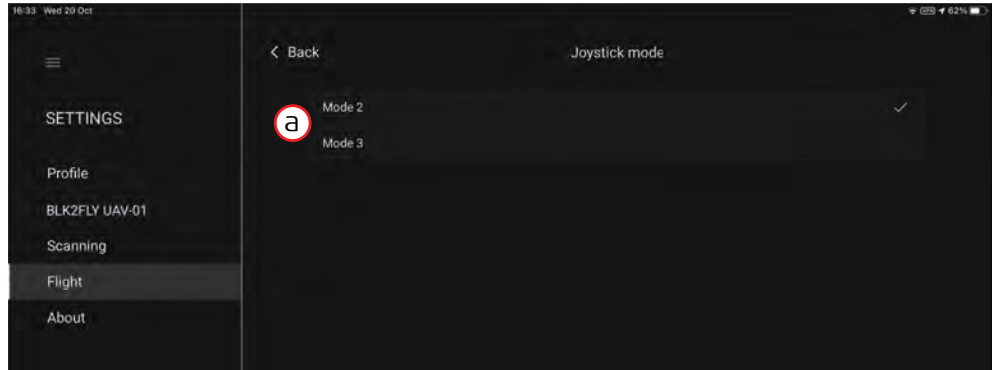

a Joystick mode

Mode 2

Left virtual joystick

Right virtual joystick

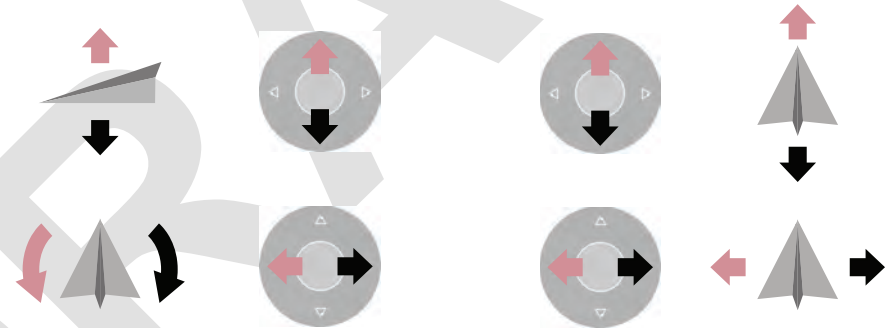

Mode 3

Left virtual joystick

Right virtual joystick

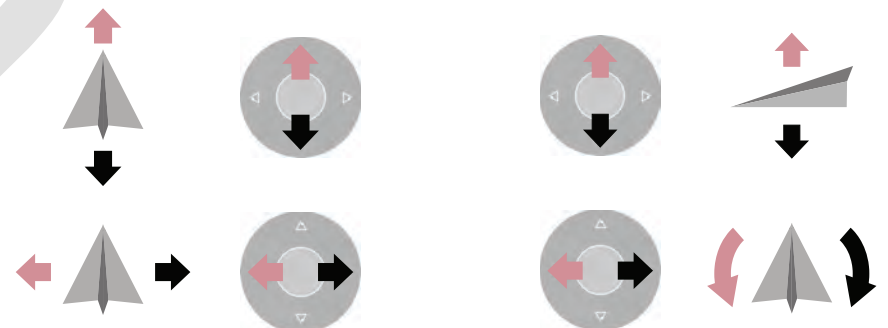

Product Feedback screen

Use this screen to share feedback with Leica Geosystems about your experience with BLK2FLY.

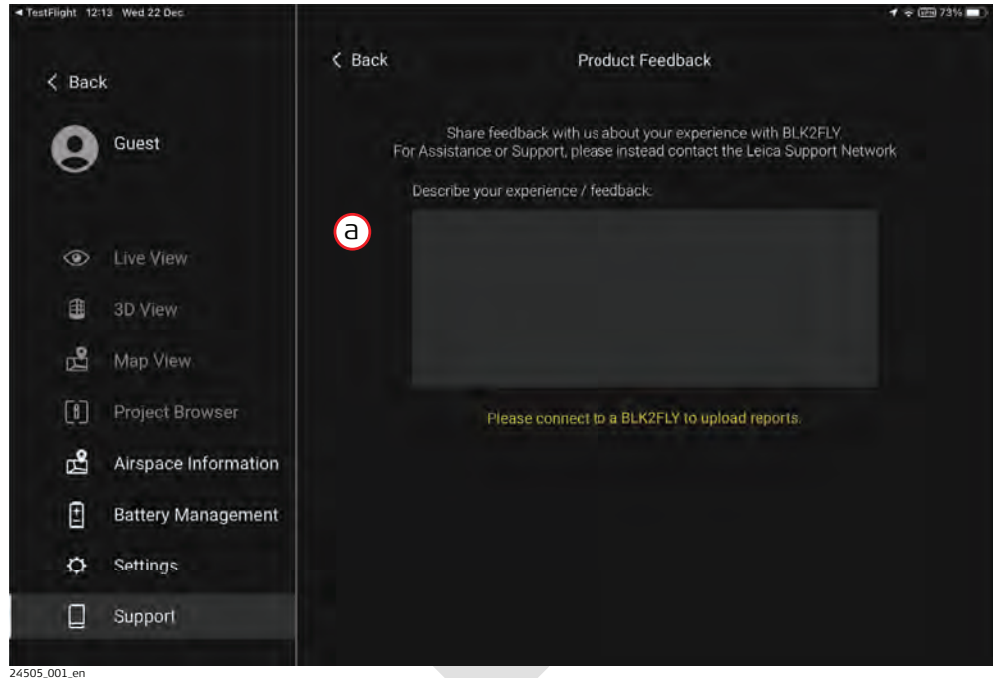

a Entry mask for sharing feedback

Issue Reporting screen

Use this screen to upload reports from your flight after any issue.

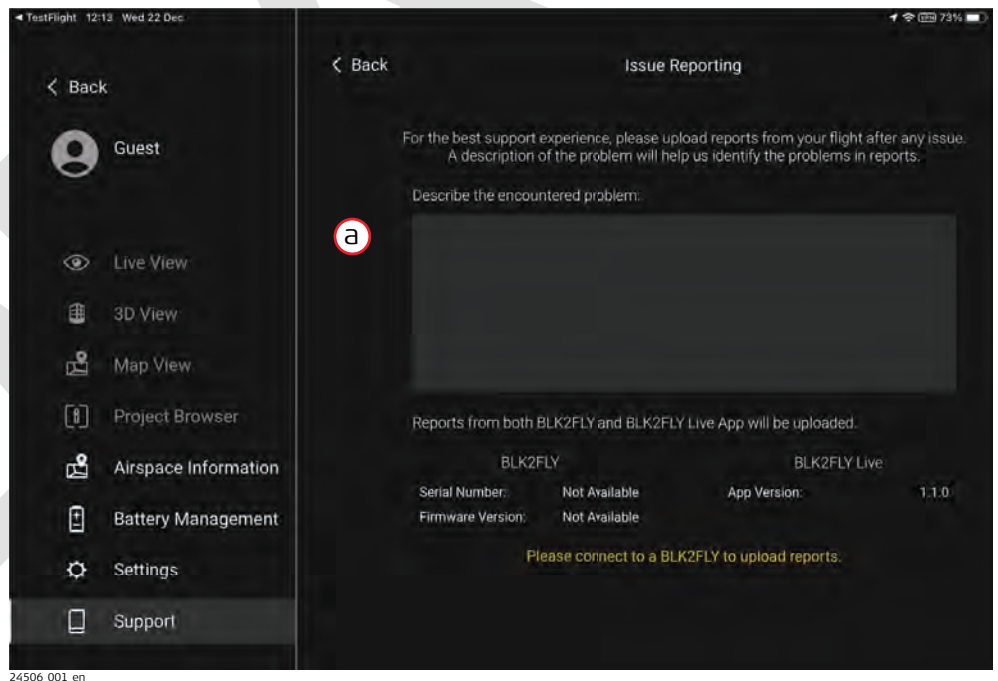

a Entry mask to describe and send an issue

Contact Support screen

Any issue using BLK2FLY? Use this screen to locate your closest Leica support contact.

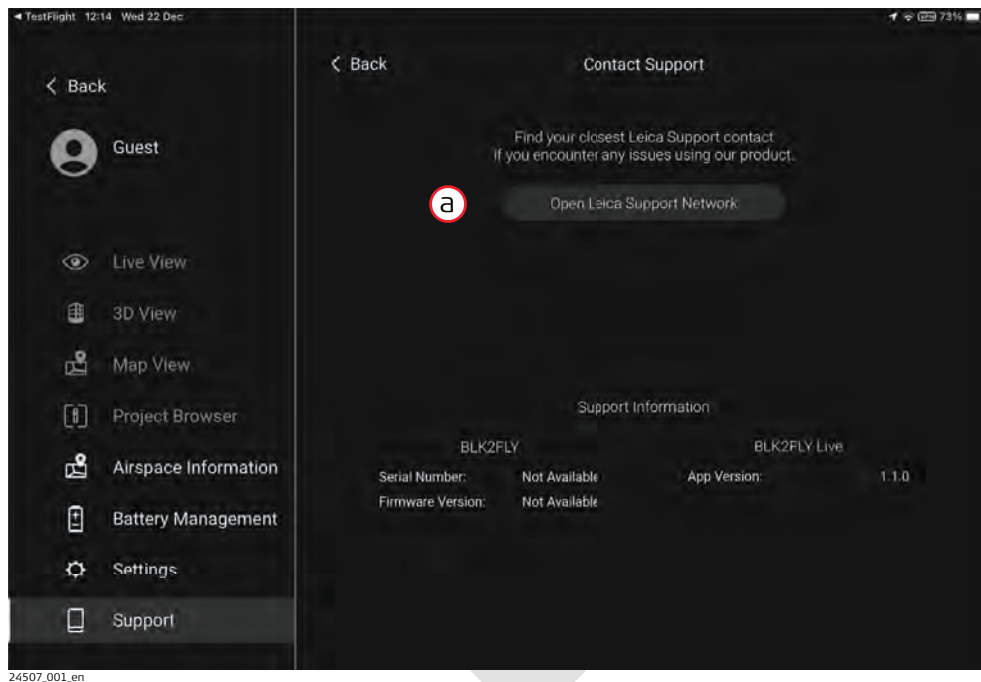

a Open Leica Support network button

- All scan/flight modes that the BLK2FLY can be operated in
- How to select the scan modes in the app
- Operational assumptions about the scan modes
- When to use the operational assumptions and when not to use them
- The level of control the operator can still exercise over the BLK2FLY in each scan mode

Description

Menu Start Scanning

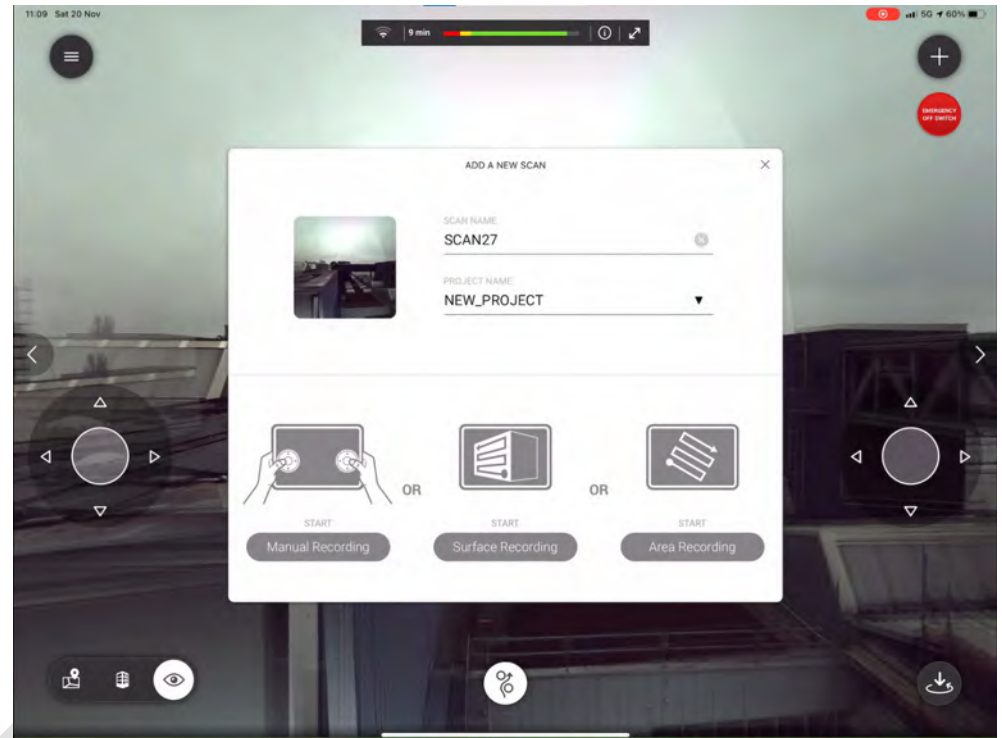

Detailed description

Menu	Description
Manual Recording	Refer to 7.7.1 Manual Recording for details.
Surface Recording	Refer to 7.7.2 Surface Recording for details.
Area Recording	Refer to 7.7.3 Area Recording for details.

Overview

This menu is used to manually operate/fly the BLK2FLY for recording.



- a Hamburger menu. Refer to 7.6 [Hamburger Menu](#) for details
 b Status bar. Refer to 7.4 [Status Bar](#) for details.

- c **Emergency off switch**
 d Add a new scan
 e Switch between different views
 f Take-off button

Manual Recording, step-by-step

1. Tap/hold the take-off button for > 3 s.
 The BLK2FLY starts and hovers at 1 m

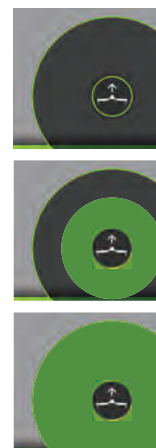

2. Tap the **+** icon to open the menu to add a new scan.



3. Tap **Manual Recording**.

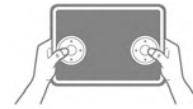

START

Manual Recording

4. The **Live View** opens. Use the virtual joysticks to control the BLK2FLY to manually record the surface/area.



As soon as the menu opens, the recording starts immediately. An active timer in the top right of the menu is indicating recording in progress. Example:



Keep an eye on the status bar for the remaining battery life-time.



5. Once the surface/ area recording is finished, the BLK2FLY returns to what is defined in the menu **Return behaviour**. Tap/hold the home icon to expand for the **Return behaviour** options.



The default setting is **Return to launch**.

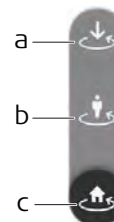

- a Land in place
- b Return to user
- c Return to launch



In case battery runs low, an acoustic warning and additional information appears on the screen. Once the count-down is finished, the BLK2FLY returns automatically to the position defined in settings. Joystick control is automatically disabled, once the battery life lasts only for direct landing any more.



NOTICE

Important: The default settings in case of low battery are only defined in settings. This setting can be different to the return menu in the normal view. Whatever is configured, they are used when return function is called manually.

DRAFT

Overview

This menu is used to fly a mission. A mission automatically records data of a predefined surface.

If the battery life does not last for the whole surface scan, divide the surface into more than one individually planned surfaces.

Currently, a surface scan stopped due to low batteries, cannot be resumed.

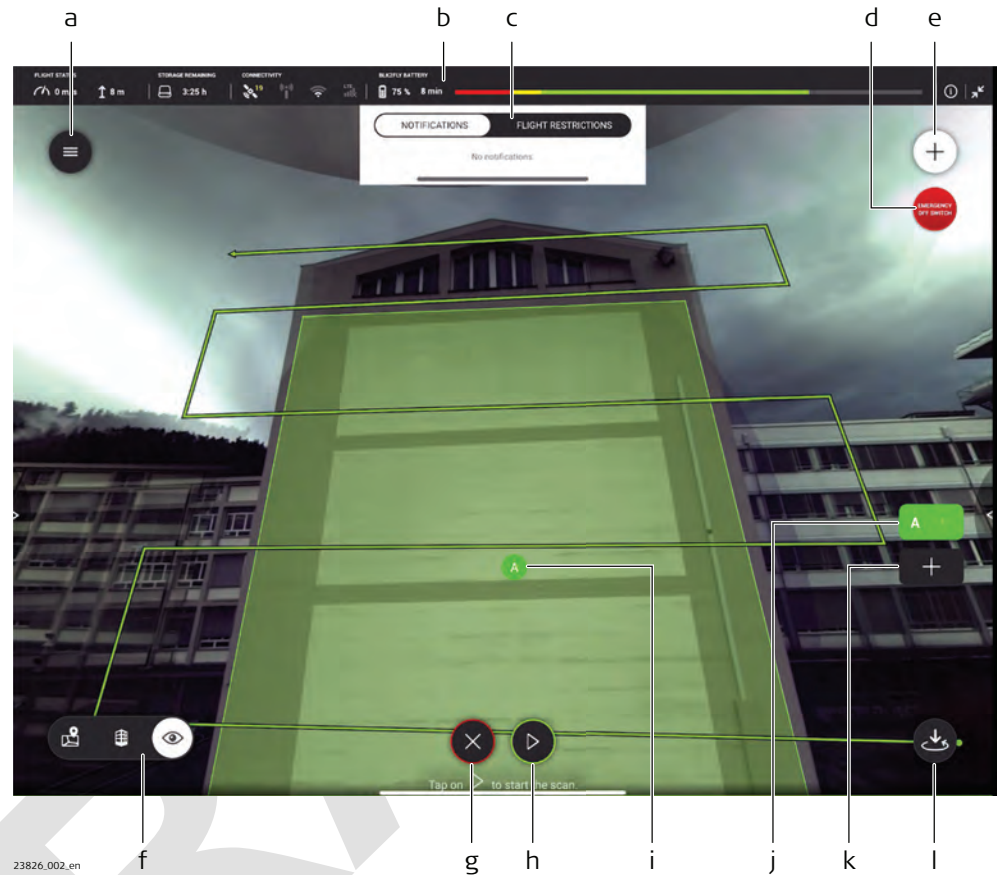

- 23826_002_en
- a Hamburger menu. Refer to 7.6 [Hamburger Menu](#) for details
 - b Status bar. Refer to 7.4 [Status Bar](#) for details.
 - c **NOTIFICATIONS** and/or **Flight Restrictions**
 - d **Emergency off switch**
 - e Add a new scan
 - f Switch between different views
 - g **Cancel** surface scan planning

- h **Start** surface scan mission
- i Represents the scan pattern A. Tap to edit
- j Tap to open the surface scan editor for scan pattern A again
- k Add another scan pattern. Simply drag and drop scan patterns A, B, ... to reorder them
- l **Return to launch** button

Surface Recording, step-by-step

1. Tap/hold the take-off button for > 3 s.
 The BLK2FLY starts and hovers at 1 m

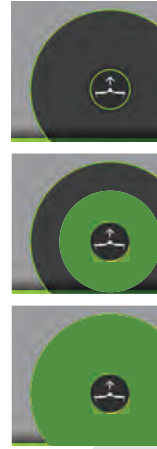

2. Tap the  icon to open the menu to add a new scan.



3. Tap **Surface Recording**.



START



Surface Recording

4. Use the virtual joysticks and/or tap/hold and shift to navigate to the front of the surface of interest.



If prompted by the BLK2FLY Live app message, fly the BLK2FLY closer to the surface. Within 20 metre from surface of interest is fine.



5. Tap on the surface to set corners to create an area for recording.
- Edit the area by tap/shift of the dots
 - Delete single dots. Use the small bin icon  near the dot
 - Delete the whole area. Use the large bin icon bottom/centre 



6. Once defined, accept the area.



The flying pattern for the surface recording is displayed. The BLK2FLY is ready to start the mission.

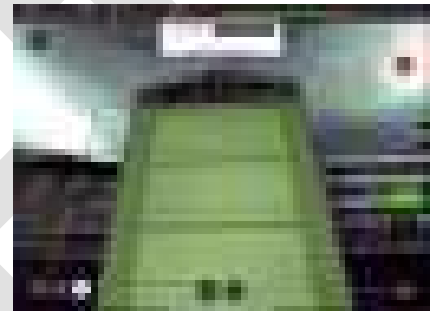

7. Option: Tap one of these buttons to open the area editor again.



8. Option: Tap to add an area to the already defined area.



9. Option: Tap  to cancel the area definition

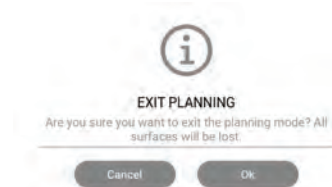

10. Tap to start the surface recording.

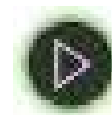

The BLK2FLY starts surface recording. Example: **Map View**

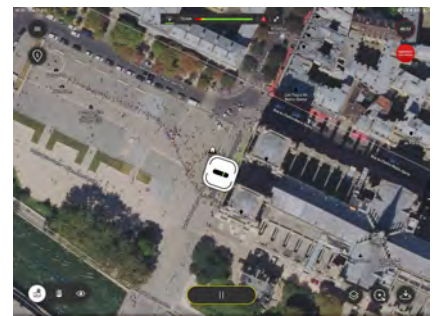

Example: **Live View**



Example: **3D View**

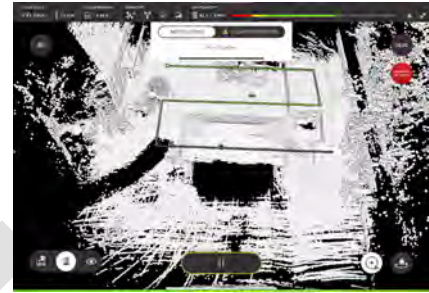

 An active timer in the top right of the menu is indicating recording in progress. Example:



 Option: Abort and return at any time. Tap/hold the home icon to expand for the home position options.

 The default setting is **Return to launch**.

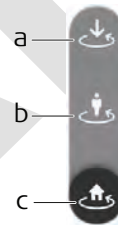

- a Land in place
- b Return to user
- c Return to launch

11. Once the surface recording is finished, the dialog box shows **Mission Completed!**
- Stop: Return the BLK2FLY and land.
 - Continue: depending on battery status, define a new area for surface recording and continue to record data.

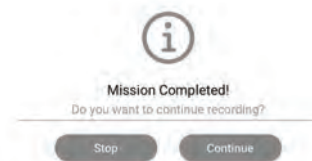

Overview

This menu is used to fly a mission. A mission automatically records data of a predefined area on ground or top side/roofs of buildings.

If the battery capacity does not last for the whole area scan, divide the area into more than one individually planned areas.

With this release version, an area scan stopped due to low batteries, cannot be resumed.

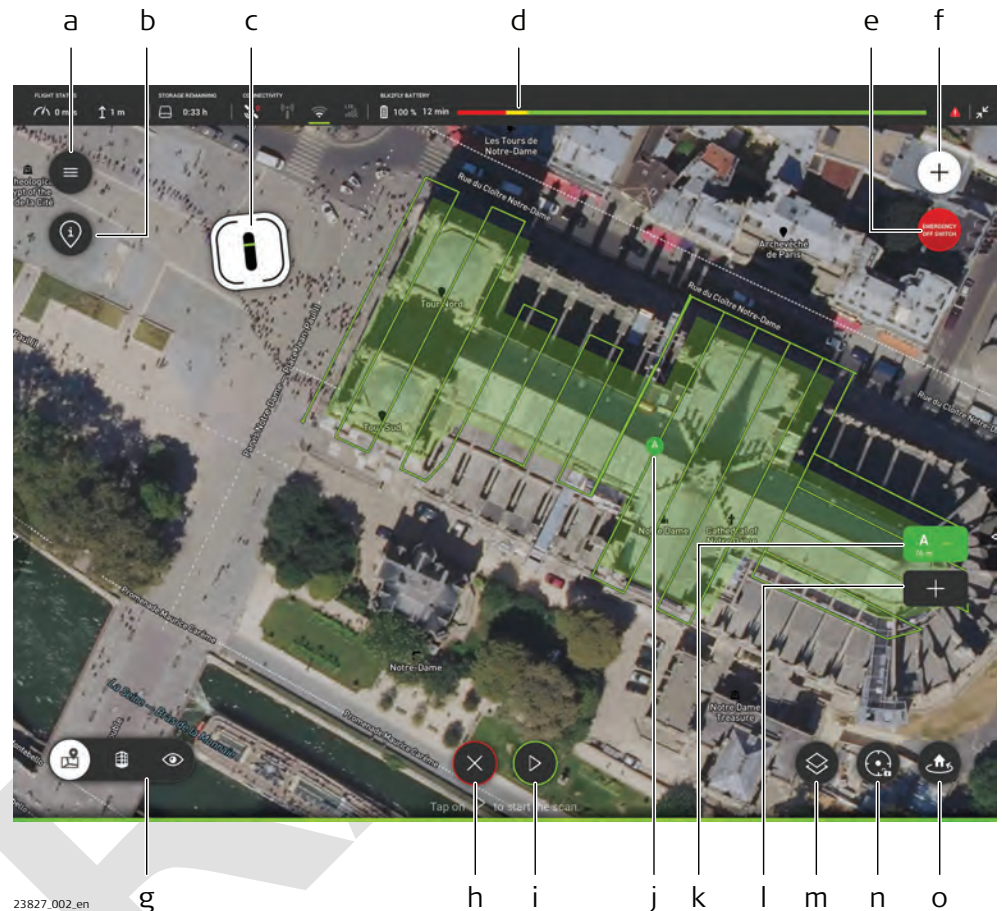

- 23827_002.en
- a Hamburger menu. Refer to 7.6 [Hamburger Menu](#) for details
 - b **AIRSPACE INFORMATION** button
 - c Current position/orientation of the BLK2FLY
 - d Status bar. Refer to 7.4 [Status Bar](#) for details.
 - e **Emergency off switch**
 - f Add a new scan
 - g Switch between different views
 - h **Cancel** area scan planning

- i **Start** area scan mission
- j Represents the scan pattern A. Tap to edit
- k Tap to open the area editor for scan pattern A again
- l Add another scan pattern. Simply drag and drop scan patterns A, B, ... to reorder them
- m **Map type** button
- n **View Center** button
- o **Return to launch** button

Area Recording, step-by-step

1. Tap/hold the take-off button for > 3 s.
 The BLK2FLY starts and hovers at 1 m

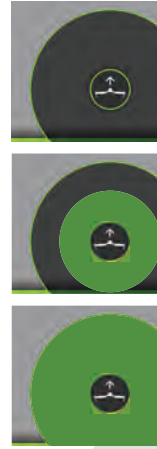

2. Tap the  icon to open the menu to add a new scan.



3. Tap **Area Recording**.





START

Area Recording

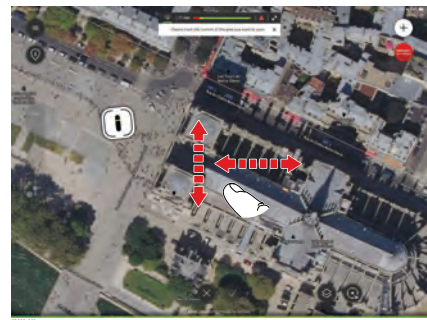
-  Tap/hold to shift the map to the area of interest.



4. Tap on the map to set corners to create an area for recording.
 - Edit the area by tap/shift of the dots
 - Delete single dots. Use the small bin icon  near the dot
 - Delete the whole area. Use the large bin icon bottom/centre 



5. Tap/shift to set the height for the BLK2FLY to fly the mission



6. Once defined, accept the area.



The flying pattern for the area recording is displayed. The BLK2FLY is ready to start the mission.

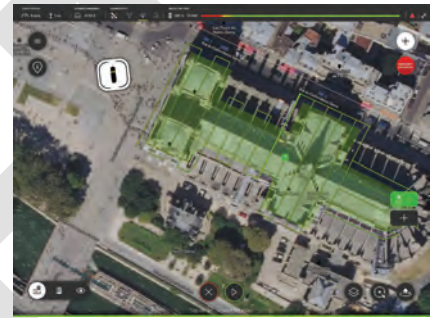

7. Option: Tap one of these buttons to open the area editor again.



8. Option: Tap to add an area to the already defined area.



9. Option: Tap  to cancel the area definition



10. Tap to start the area recording.

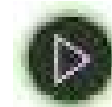

The BLK2FLY starts area recording. Example: **Map View**

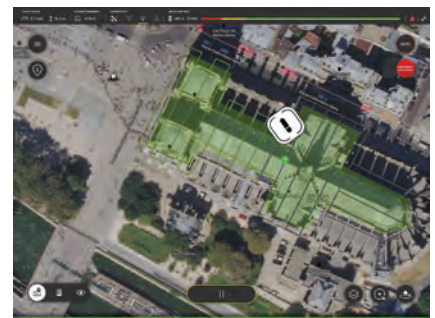

Example: Live View



Example: 3D View

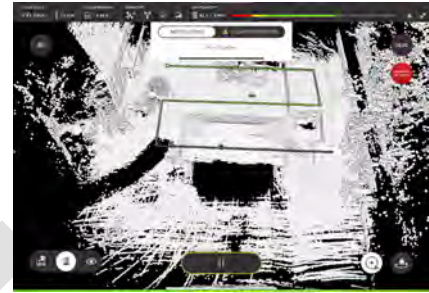

 An active timer in the top right of the menu is indicating recording in progress. Example:



 Abort and return at any time is set for automatic return to home due to low battery. There is no connection with the home button on the screen while flying.

11. Option: Abort and return to home at any time. Tap once, to trigger return to the location defined in settings.

 The default setting is **Return to launch**.

Tap/hold the home icon to expand for the home position options.

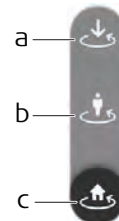

- a Land in place
- b Return to user
- c Return to launch

12. Once the surface recording is finished, the dialog box shows **Mission Completed!**
- Stop: Return the BLK2FLY and land.
 - Continue: depending on battery status, define a new area for surface recording and continue to record data.

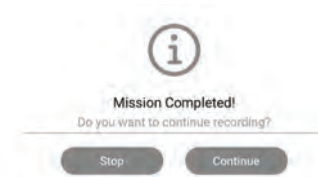

8

Alerts, Geo-awareness, Operational Information

8.1

Description of Alerts, Warnings and Information

Warnings

Warnings are always in the center of the screen, just below the status bar.

Example: Low battery in 3D View

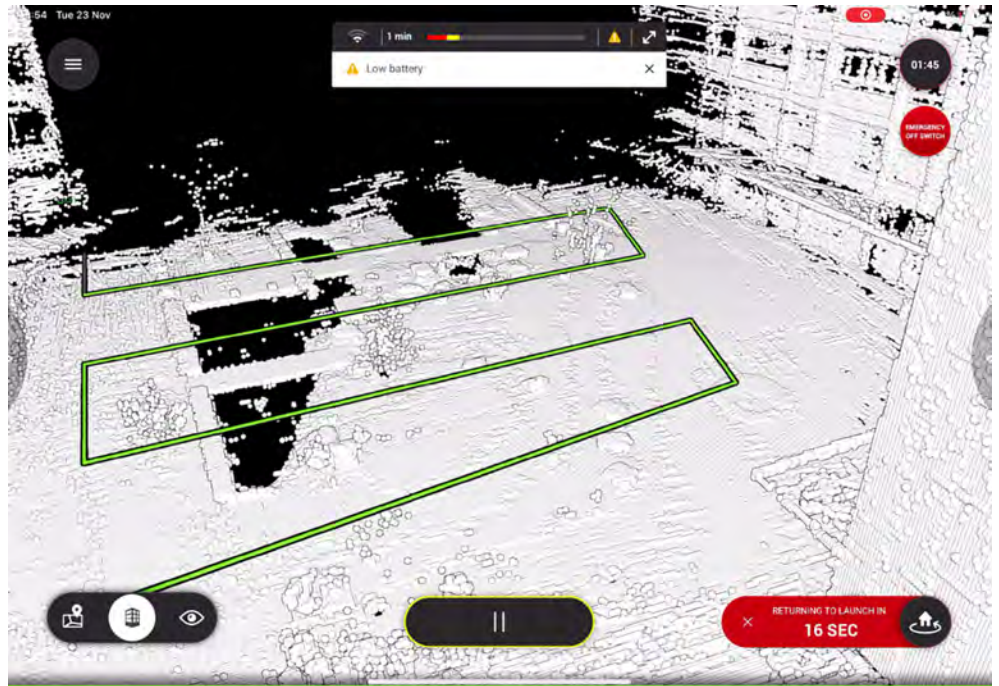

Example: Low battery in Live View

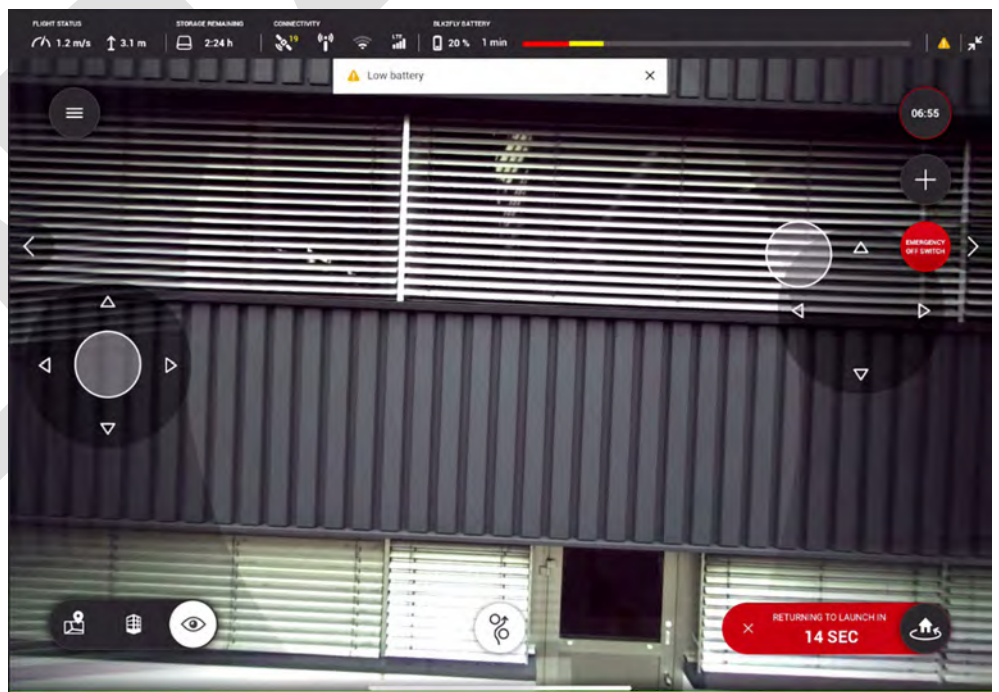

Flight restrictions

Tap on  to see flight restriction information on map and a specific location.

Flight restriction information on map

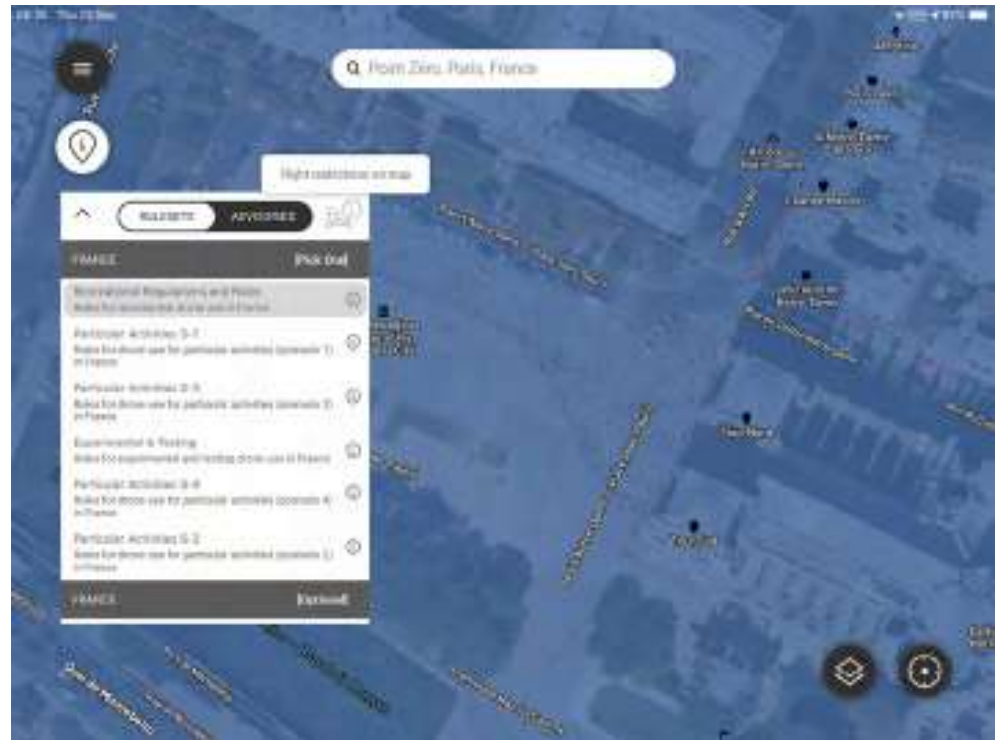

Flight restriction information on a specific location

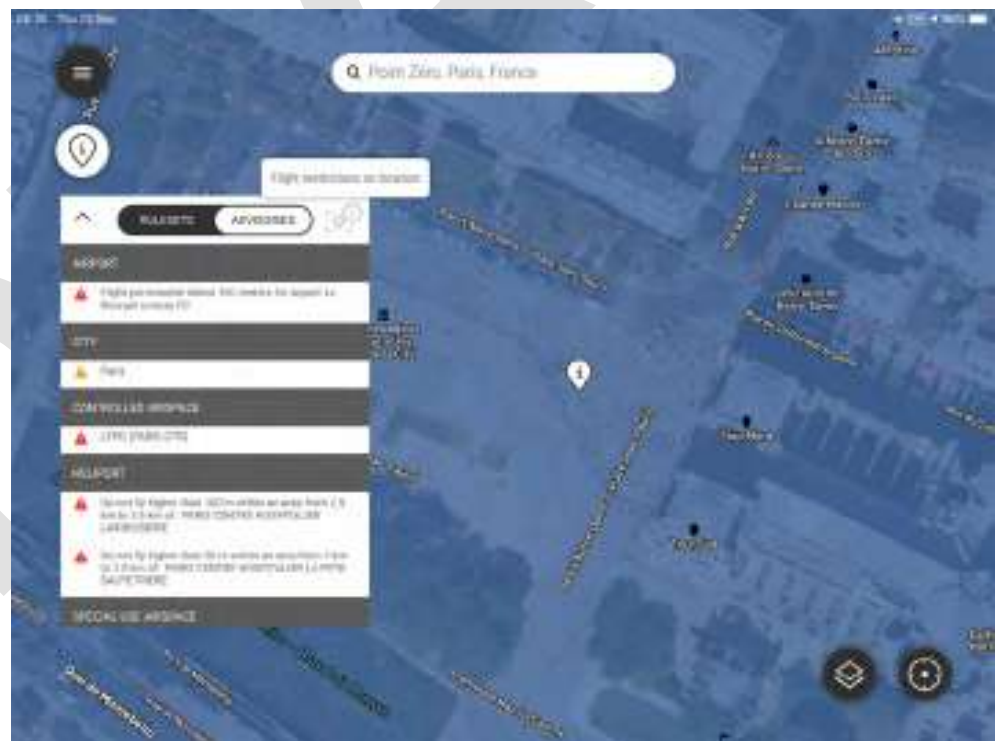

Notifications

Warning messages that have occurred are listed under NOTIFICATIONS.



DRAFT

8.2

Geo-awareness System, Fencing

8.2.1

Geo-awareness System

Once the fencing is set up and active, BLK2FLY cannot pass the fence. This flight limitation is valid for horizontal and vertical direction.

When the BLK2FLY flies into the active fence, it stops continue flying in that direction automatically. An error message is shown.



8.2.2

Fencing

Set up the fencing, step-by-step

Follow this procedure to set up a fencing area to keep the BLK2FLY within safe flight area.

 Grey button: the fencing set up is deactivated.



White button: the fencing set up is activated.

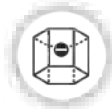

1. Tap the Fencing button to activate the setup.
2. Tap on the satellite view/map view to set the first position of the fence.
3. Tap on another position to set the second point of the first line of the fence.

4. Continue to set corners of the fence to limit flight space.
- Move/delete the highlighted edgepoint to set up an appropriate fence
 - Add edgepoints using the small grey dots in-between two white corners

Example:

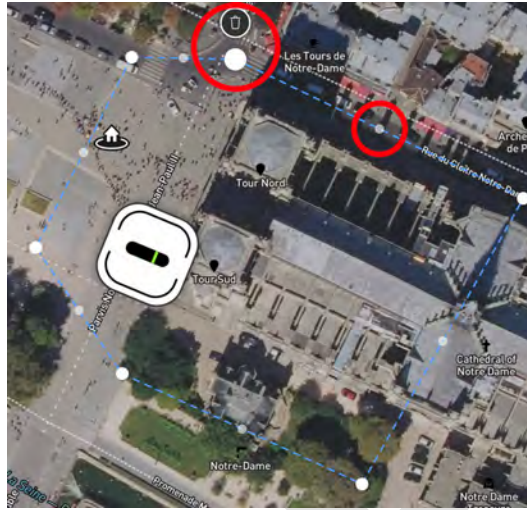

5. Define the maximum flight height by using the slider on the left side. The maximum set flight height is displayed on top of the slider. Example: 85 m



When flying, the slider shows the current flight height of the BLK2FLY. Example: 31 m

6. Tap **OFF** to activate the fence and finalise the setup.



Button turns to **ON** indicating that geo-awareness/fencing is activated.

7. Tap the tickmark or the fencing button to leave the fencing editing mode.



When in editing mode, the fence can always be deleted using the bin symbol.

DRAFT

9 Description of Further Components

9.1 Battery

Smart Battery GEB374 The battery type is LiPo (Lithium-Ion-Polymer).

Refer to the enclosed Leica GKL352 Quick Guide or documentation on <https://myworld.leica-geosystems.com> for details.

- Charge/discharge the battery
- Obtain information about battery charge status

 Check the Smart Battery GEB374 for inflation or damage. You must never use problematic batteries.

 Charge the Smart Battery GEB374 at least once every 3 months to 60% for optimal storage and lifetime.

 It is recommended to store the battery at around +20 to +25 °C.

 Always remove the Smart Battery GEB374 from the BLK2FLY if not operated in order to prevent battery damage.

9.2 Single Charger

**Single charger,
Leica GKL352**

The single charger Leica GKL352 is shipped together with the BLK2FLY. A single Smart Battery GEB374 can be charged at a time. Refer to the enclosed Leica GKL352 Quick Guide or documentation on <https://myworld.leica-geosystems.com> for details.

- Make sure that the single charger is in working condition
 - Check the connectors before use. Replace the single charger in case of bent or broken contacts
 - Check the cables before use. Replace broken cables or if connectors are defective
-

9.3 Multi-charger

**Multi-charger,
Leica GKLxyz,
available in 2022**

Order the multi-charger Leica GKLxyz as an optional accessory. Up to five Smart Battery GEB374 can be charged at a time. Refer to documentation on <https://myworld.leica-geosystems.com> for details.

- Make sure that the multi-charger is in working condition
 - Check the connectors before use. Replace the multi-charger in case of bent or broken contacts
 - Check the cables before use. Replace broken cables or if connectors are defective
-

10 Operation

10.1 Setup Procedures

10.1.1 Airspace Limitations

AIRSPACE INFORMATION is automatically available when being on-site and checking the airspace information in the BLK2FLY Live app in **Map View**. An Internet connection over the SIM card or WLAN is mandatory.

It is also possible to open the **Map View** within the BLK2FLY Live app in the office being connected to WLAN, pan within the map to the upcoming flight areas and check the airspace information.

 The airspace information cannot be downloaded to be shown in off-line mode. It is live information only. Therefore it is highly recommended to have always the Apple iPad with SIM card and mobile data activated.

Refer to [7.6.5 AIRSPACE INFORMATION Screen](#) for details.

10.1.2 Firmware Updates

The firmware update requires an Internet connection. Use WLAN or LTE on the Apple iPad to download new firmware.

In order to upload firmware to BLK2FLY and the Smart Battery GEB374, the BLK2FLY Live app must be paired with the correct BLK2FLY.

 The BLK2FLY Live app can only be updated over the Apple App store.

10.1.3 Configure GNSS RTK

Follow these steps to configure GNSS RTK for network corrections. Refer to [SmartNet/NRTK Configuration screen](#) for details.

Supported data and network protocols:

RTK data protocols: RTCM v3.0, v3.1, v3.2 MSM

RTK Network protocol: iMAX, MAC (RTCM SC 104), VRS, FKP

10.2 Preparation Procedures

- The operator must check himself, whether operational approval by his civil aviation authority or other entity is needed. If so, he is responsible to perform all the risk assessment and concept of operations (ConOps). Refer to [3 Regulatory Situation](#) for details.
 - Charge the required number of batteries
 - Ensure the Apple iPad is charged
 - Check weather forecast. The BLK2FLY cannot be flown in rain and strong wind conditions. Refer to [6.3.1 Meteorological Conditions](#) for details
-

10.3

Pre-flight Procedures

Overview

- Visual inspection of BLK2FLY
- Take off and landing zone:
 - It is recommended for take off and landing zone, to have at least 4 m clear distance to any potential obstacles
 - Ensure a safe take off and landing area
- Take off and landing zone on grass: The BLK2FLY is able to take off and land on grass. However, the grass should not be higher than 5 cm above the ground. This ensures that the rotor and obstacle avoidance operate correctly.
- Environmental and weather conditions:
 - Ensure the environmental and meteorological conditions are adequate for BLK2FLY operation
 - Refer to [6.3.1 Meteorological Conditions](#) for details

Checklist

- Check if compass calibration is needed. Refer to [10.4 Compass Calibration](#) for details
- Environmental and weather conditions allow BLK2FLY operation
- Check for charged batteries
- Ensure a safe take off and landing area
- Check airspace information
- Ensure fencing is set up and active if required
- Ensure **Return behaviour** is defined as required. Refer to [Return behaviour screen](#) for details

10.4

Compass Calibration

Overview

Be sure to calibrate the compass before the first flight. After that, calibrate the compass when the BLK2FLY Live app prompts to do so.

 Take-off is prevented and pilot gets an information message (in flight screen) once compass calibration is required.

When and how to run compass calibration in general

- When moving to new sites, a compass calibration is more likely to be needed
- Compass calibration shall be executed in area free of magnetic fields
- Keep enough distance to metal structures, metal pipes, on top on concrete with rebar or any other place where magnetic interferences likely to be present
- User should not wear watches, or other objects which can distort natural magnetic field. UAV should be able to get GNSS position
- Apple iPad can create magnetic field distortions. Ensure the Apple iPad is at sufficient distance while calibrating.

Step-by-step

Follow this procedure to calibrate the compass of the BLK2FLY

1. Tap the hamburger menu icon.



☞ The hamburger menu slides in from the left side. Example:

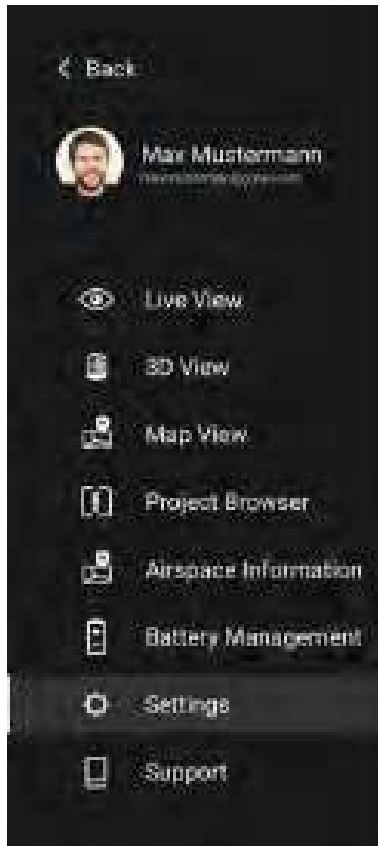

2. Tap on **Settings**.

☞ The settings for the BLK2FLY are shown. Example:

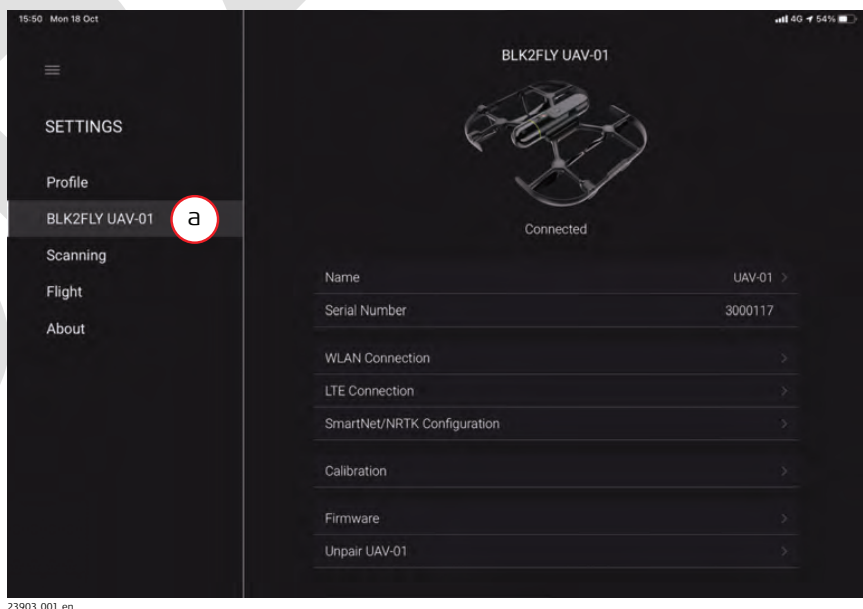

3. Tap on a) in the **Settings** menu.



The **Calibration** menu opens.

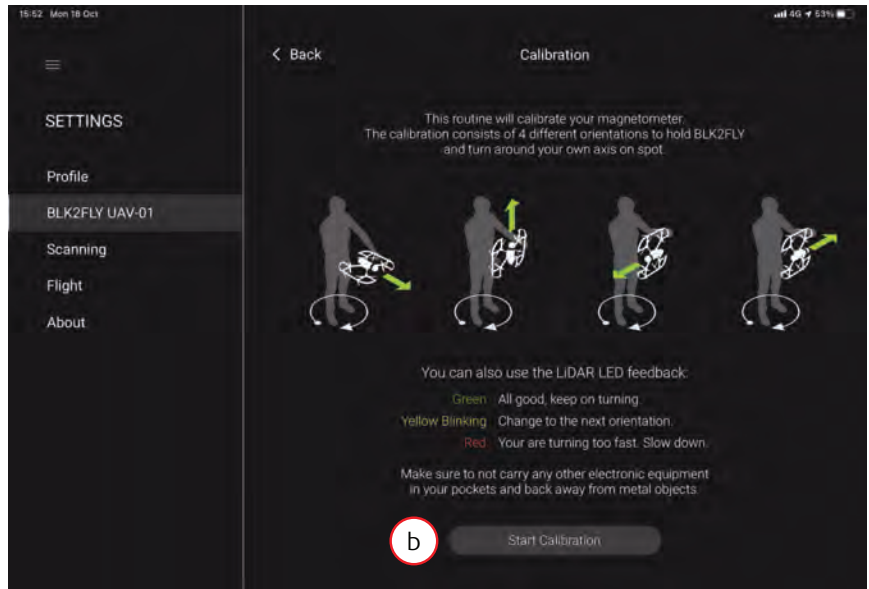

23583.001_en



Read the instructions on the page.

4. Tap b) **Start Calibration** to start the calibration.
5. Follow the calibration guide step 1–4 as shown on the screen. Refer to [Blinking patterns](#) for help during the calibration.

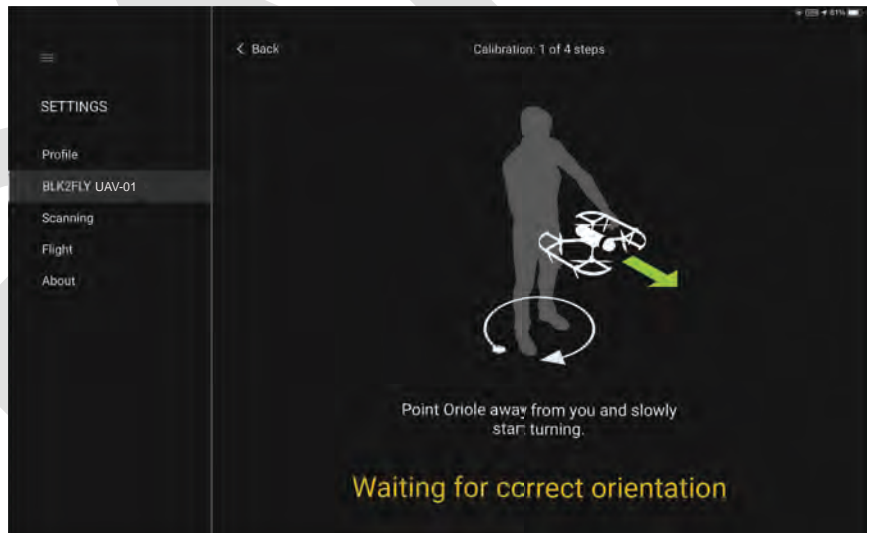

23584.001_en



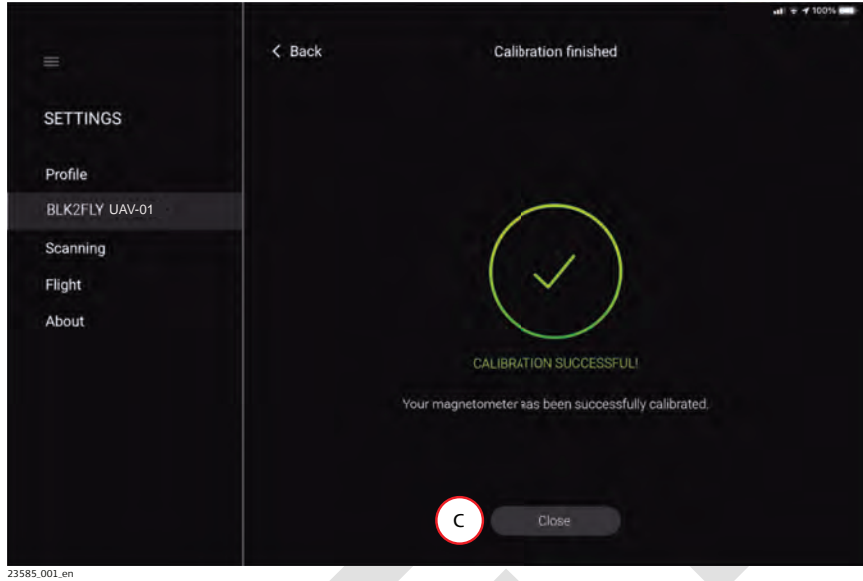

- After successful calibration, the message **CALIBRATION SUCCESSFUL** is displayed.



- Tap c) **Close** to close this menu and finish the calibration.

Blinking patterns

LiDAR

LED ring colour	Lighting interval	Instrument status
	0.5 Hz pulsating, 100% / 10% brightness	Keep rotating.
	2 Hz blinking for 10 s, 100% / 0% brightness	Finished calibration.
	0.5 Hz pulsating, 100% / 10% brightness	Next step / wrong direction.
	2 Hz blinking, 100% / 0% brightness	Rotating too fast.

Position LED

Lighting interval	Instrument status
0.5 Hz pulsating	Keep rotating.
2 Hz blinking	Next step / wrong direction.
2 Hz blinking for 10 s	Finished calibration.

Calibration failed

The pilot can tap < **Back** at any time to cancel the calibration procedure.

Restart of compass calibration is possible then.

Possible reasons

- GNSS is not available
- Generic calibration error. Something went wrong.
 - Make sure to turn around slowly, around 8 s per turn
 - Make sure to have empty pockets
 - Make sure to not be close to metal objects
- BLK2FLY positioned in wrong orientation
 - If BLK2FLY is positioned in the wrong orientation, the BLK2FLY Live app waits until the BLK2FLY is in the required orientation

10.5

Flight Procedures

Normal procedures

Procedures used during normal flight:

- Take-off
- Land
- Change altitude
- Operator-controlled operation procedures
- Initiate building scan
- Monitoring of environmental conditions
- Monitoring of airspace
- Always check battery level
- BLK2FLY must always be in line of sight
- Ensure that obstacle avoidance is always enabled

Contingency procedures

Contingency procedures come into effect in abnormal situations. In these situations, it is no longer possible to continue the flight using normal procedures. The safety of the aircraft or persons on the ground is not in danger.

- Especially in automatic flights, the pilot must be ready to take over the control of the BLK2FLY at any time
- In case of doubt for completing a mission, pause the automatic flight or land the BLK2FLY. Doubts may rise due to changing environmental conditions, abnormal behaviour of BLK2FLY, other aircraft close by.

Refer to [12 Troubleshooting](#) for details.

Emergency procedures

Safety has always highest priority.

Type	Details
Obstacle avoidance	If possible, always keep obstacle avoidance activated. This is important to ensure safety during scans and when returning back home.
Emergency case	For example: <ul style="list-style-type: none">• BLK2FLY is flying away• Crash with another aircraft is about to happen
Turn off engines	It is possible to turn off the motors of BLK2FLY while still flying. This way, the BLK2FLY is crash landing in its current position. Greater damage is prevented. <ul style="list-style-type: none">• Refer to Emergency off switch. for details• Refer to 12 Troubleshooting for details

Recommended post-flight procedure

- Visual inspection of the BLK2FLY
- In case the unit got damp, ensure to take it out of the transportation case as soon as possible to dry
- Charge batteries again
- Connect the BLK2FLY to a computing device using WLAN or the USB-C type cable
- Upload data to HxDR in the BLK2FLY Live app under Settings > Profile

Connect BLK2FLY to USB-C Cable for data download

1. Remove the Smart Battery GEB374 to get access to the USB-C port.
2. Connect the included USB-C cable to the BLK2FLY.



3. Connect the BLK2FLY to the computer.



The BLK2FLY boots up automatically. It is then visible for:

- Leica Cyclone REGISTER 360
- Leica Cyclone REGISTER 360 (BLK Edition)
- Leica Cyclone BLK Data Manager

In case an issue needs to be reported to Leica support, go to the **Support** menu to upload logs. Refer to [7.6.8 Support Screen](#) for details.

Post processing software

- Leica Cyclone REGISTER 360
- Leica Cyclone REGISTER 360 (BLK Edition)
- HxDR
- Leica Cyclone BLK Data Manager

Occurrence reporting is mandated by law. Information is available from the national aviation authority.

- It is the pilots responsibility to report any occurrence happened while flying with the BLK2FLY
- The operator must know how to recover flight log information from the BLK2FLY. Refer to [7.6.8 Support Screen](#) for details
- He must know how to recover geo-awareness information. For example timestamp of last update of geo-awareness data and operational status
- Verify, that information was not manipulated
- The occurrence report must be sent to the national aviation authority
- The pilot must know local emergency numbers



For example:

[Swiss Federal Office of Civil Aviation FOCA - occurrence reporting](#)

DRAFT

11

Maintenance

11.1

Maintenance Plan

General

BLK2FLY is a professional UAV solution and is used in varying conditions. It needs regular maintenance to maximise the usage, life and secures the investment of the UAV solution. Find this guideline on maintenance activities that the pilot and Leica Geosystems Service Center should perform for the system regularly. In a summary, the intervals are:

- Every flight check (before and after)
- 5 hours flight time check
- 50 hours flight time check
- 200 hours flight time check

Every flight

Minor service performed by pilot before and after every flight.

Before flight

- Check landing gear: Intact, no cracks, clean
- Check propellers: Propeller edge check, flex for delamination/cracks, clean
- Spin all propellers to check motors: Listen for noises, look for irregularities
- Visual inspection of the BLK2FLY body and LiDAR lighthouse
- Check the camera lenses are clean

After flight

- Motor check: Feel for excess heat on all motors
- Check landing gear: Intact, no cracks, clean
- Check propellers: Propeller edge check, flex for delamination/cracks, clean
- Visual inspection of the BLK2FLY body and LiDAR lighthouse

5-hour check

Minor service performed by pilot once a week or after a long day.

- Clean any dirty surfaces: Camera lens, propellers, BLK2FLY body, landing gear
- Clean the LiDAR lighthouse. Be careful. Refer to [General](#) for details
- Battery inspection for battery life/damage/puffing/charge levels

50 hour/200 flight check

This service is recommended after 50 hours or 200 flights.

BLK2FLY

- Visual inspection of all components: Motors, propellers, landing gear, cameras, LiDAR, Time of flight sensor
- If applicable, firmware updates for:
 - BLK2FLY
 - Apple iPad
 - Batteries

Apple iPad tablet

- Functional test
- Installation of latest firmware and applications

Acceptance test flight

- BLK2FLY flight performance test

General

- Cleaning of entire BLK2FLY system

200 hour/800 flight check

This service is recommended after 200 hours or 800 flights.

BLK2FLY	<ul style="list-style-type: none">• Visual inspection of all components: Motors, propellers, landing gear, cameras, LiDAR, Time of flight sensor• If applicable, firmware updates for:<ul style="list-style-type: none">- BLK2FLY- Batteries
Apple iPad tablet	<ul style="list-style-type: none">• Functional test• Installation of latest firmware and applications
Acceptance test flight	<ul style="list-style-type: none">• BLK2FLY flight performance test
General	<ul style="list-style-type: none">• Cleaning of entire BLK2FLY system

Every year

This service is recommended every year.

- Replace the propellers after flying over 300 hours or using for one year
 - Ship the BLK2FLY to your local Leica Geosystems Customer Support Centre for inspection and overhaul
-

11.2

Manufacturer Repair

In case other parts of the BLK2FLY are damaged, Leica Geosystems support must be contacted. Refer to [7.6.8 Support Screen](#) for details.

11.3

Maintenance Recordkeeping

We recommended recording when propellers have been exchanged.



Important: Follow the recommendations in [11.1 Maintenance Plan](#).

11.4

Recommended Training

A product training is recommended for BLK2FLY. Such a training allows correct handling of the device.

Help for troubleshooting

Problem	Solution
BLK2FLY cannot take off – LiDAR LED ring is yellow.	BLK2FLY is not ready to take off. This can be due to reasons like: <ul style="list-style-type: none"> • BLK2FLY standing on a tilted or moving platform • System error – check the BLK2FLY Live app for error message • Make sure the BLK2FLY is correctly unfolded Contact a Leica Geosystems authorised Service Centre for further investigation.
Symptoms of dirty camera lenses.	<ul style="list-style-type: none"> • Soiling of the glass pane can cause extreme measurement errors and therefore useless data. • May cause moderate flight performance issues.
Symptoms of dirty LiDAR.	Due to the encapsulated mirror design, the mirror is protected against direct contact. But dirt on the dome such as a layer of dust, condensation or fingerprints may cause considerable measuring errors.
BLK2FLY is stuck in air. It does not move.	<ul style="list-style-type: none"> • Try activating the virtual joysticks to fly away from any obstacles • If BLK2FLY does not react to inputs, it might be stuck in ghost obstacles – obstacles detected around it, that do not really exist • Deactivate obstacle avoidance when in virtual joystick mode, manoeuvre BLK2FLY away from obstacles and activate obstacle avoidance again
BLK2FLY Live app seems to have lost connection to BLK2FLY during flight.	No worry! The BLK2FLY is hovering in case of BLK2FLY Live app control loss. In any way, at low battery, the BLK2FLY makes its way back to the home point and lands autonomously.
When using tap to fly in 3D View or the return to home, BLK2FLY does not start flying.	It might be, that BLK2FLY cannot find a path to the desired 3D point or the home point respectively. Try to get closer in choosing a 3D point that is closer to BLK2FLY and in well-known space, for example at a location BLK2FLY flew through before.
BLK2FLY fails to pair.	Search for available BLK2FLYs again.
BLK2FLY is blinking blue but cannot be found during pairing.	Restart the device.
BLK2FLY LED blinks red/ solid red after booting.	Restart the device.
Planned surface scan mission does not match the facade.	Get more points on the facade.

Problem	Solution
New firmware failed to upload to the BLK2FLY.	Retry uploading.
Connection between Apple iPad and BLK2FLY is lost and does not recover. No LTE.	<ul style="list-style-type: none"> • Check WLAN connection • Restart the BLK2FLY Live application
After planning a mission, data recording is not starting.	<ul style="list-style-type: none"> • Check free space: Telemetry information bar; recording time left should be > 0 • Delete old data like projects or individual recordings • Reboot the BLK2FLY
BLK2FLY fails to start or proceed with planned mission.	<ul style="list-style-type: none"> • Adjust BLK2FLY position by manual control, move a few metres in any direction and retry resuming/starting the mission. • In more challenging environment, consider manual scanning as alternative to automated one.

DRAFT

13 Care and Transport

13.1 Storage

Product





Respect the temperature limits when storing the equipment, particularly in summer if the equipment is inside a vehicle. Refer to [14 Technical Data](#) for information about temperature limits.

Smart Battery GEB374

The battery type is LiPo (Lithium-Ion-Polymer).

Refer to the enclosed Leica GKL352 Quick Guide or documentation on <https://myworld.leica-geosystems.com> for details.

- Charge/discharge the battery
- Obtain information about battery charge status

-  Check the Smart Battery GEB374 for inflation or damage. You must never use problematic batteries.
-  Charge the Smart Battery GEB374 at least once every 3 months to 60% for optimal storage and lifetime.
-  It is recommended to store the battery at around +20 to +25 °C.
-  Always remove the Smart Battery GEB374 from the BLK2FLY if not operated in order to prevent battery damage.

13.2 Cleaning and Drying

General

Only use a damp microfibre cloth to clean the BLK2FLY. Do not use detergent on carbon fibre parts. Use a brush to remove loose dust.

NOTICE

Prevent scratching the LiDAR lighthouse

- ▶ Remove particles very careful. Do not scratch the LiDAR lighthouse.

13.2.1 Dome Cleaning Procedure

General cleaning information

The dome must be kept clean. The instructions must be followed as described in this chapter to clean the dome.

CAUTION

Before any cleaning procedure, ensure that the instrument is switched off and the battery has been removed.

Dust and debris on the dome

Using a compressed gas duster or canned air, remove dust and debris from surface of the dome.

-  Never rub off dust or debris as this will scratch the glass and so possibly cause permanent damage to the special optical coatings.

Cleaning of the camera lenses

Soiling of the glass pane can cause extreme measurement errors and therefore useless data!

-  All soiling that is visible on the glass pane has to be removed, except for single small dust particles that adhere inevitably.

For the glass cleaning procedure, the wet and dry lens cleaner Green Clean LC-7010 is recommended (www.green-clean.at/en.html).

Clean the glass pane regularly with the recommended cleaning tissue:

- Switch off instrument and remove the battery.
- Washing hands is necessary in order to avoid grease on the cleaning tissue.
- Better, use gloves to avoid finger oil on the glass.
- Then use the wet lens cleaning tissue (Green Clean LC-7010) until there is only a thin film of detergent visible.
- After that use the dry lens cleaning tissue (Green Clean LC-7010) to remove any remaining detergent.
- If any smears from cleaning are visible against back light, repeat the procedure.
- Do not use air from the pneumatic power system as this is always slightly oily!

Damp products

Dry the product, the container, the foam inserts and the accessories at a temperature not greater than 40 °C and clean them. Do not repack until everything is completely dry.

Cables and plugs

Keep plugs clean and dry. Blow away any dirt lodged in the plugs of the connecting cables.

13.3

Transport

Transport in a road vehicle

Never carry the product loose in a road vehicle, as it can be affected by shock and vibration. Always carry the product in its container and secure it.

Handcarrying the BLK2FLY

- Hold it either on the mainbody or inner arms
- Prevent holding the BLK2FLY at the shrouding or outer arms
- Watch out not to touch/scratch the LiDAR lighthouse, camera and tof lenses
- Watch out for the propellers when folding BLK2FLY. Do not scratch the lighthouse.

Shipping

When transporting the product by rail, air or sea, always use the complete original BLK2FLY packaging, container and cardboard box, or its equivalent, to protect against shock and vibration.

Shipping batteries

Discharge batteries to around 30%.

14.1

BLK2FLY

Environmental specifications

Temperature

Type	Operating temperature [°C]	Storage temperature [°C]
BLK2FLY	+5 to +35	-10 to +60
Apple iPad tablet	-20 to +40	< than 3 months: -28 to +45 > than 3 months: +22 to +30
Smart Battery GEB374 Lithium-Ion-Polymer	+10 ³⁾ to +35	-10 to +45 Recommended +20 to +25
Single Charger Leica GKL352	+10 to +30	-10 to +60
Multi-charger	+10 to +30	-10 to +60

Aircraft

IP rating	IP54 (IEC 60529) in non-operating mode. Dust protected.
Humidity	Protection against splashing water from any direction. Humidity max. 95% non condensing.
Pollution degree	2
Use at altitude	Electrical safety is guaranteed ≤ 2000 m above sea level.

Dimensions

Aircraft	L × W × H [cm]
Unfolded	53 × 60 × 19
Folded	53 × 32 × 14
Propeller	[inch]
Diameter	10
Pitch	4.5

Weight

Type	Weight [kg]
BLK2FLY including battery	2.6
Maximum takeoff mass MTOM	2.6 No additional weight must be added.

Flight performance

Type	Value
Typical flight time ⁴⁾	13 min
Maximum speed, obstacle avoidance inactive	5 m/s

³⁾ Flight start temperature at +5 °C is allowed, once the temperature of the Smart Battery GEB374 is ≥ 10 °C when flight starts.

⁴⁾ Flight time depends on operation mode, weather conditions, altitude and payload

Type	Value
Maximum speed, obstacle avoidance active	3 m/s
Maximum wind resistance	12 m/s
Maximum flight altitude above sea level	1800 m (5900 ft)
Flight time	13 min ⁵⁾
Hovering accuracy: P-mode, with GPS	Vertical: ± 0.5 m, Horizontal: ± 1.5 m
Maximum pitch angle	25°

Sound power level



According to the safety standard IEC 61010-1, it is necessary to wear hearing protection at levels higher than 80 dB.

Therefore, a minimum distance of 6 m from the BLK2FLY must be maintained during take-off and landing. There, the value is lower than 80 dB. For each country, the pilot is responsible for clarifying the valid limit values beforehand.

Power management

Refer to [14.2 Smart Battery GEB374](#) for details.

GNSS

Multi-band GNSS high precision receiver.

Supported signals

System	Signal
GPS	L1C/A, L2C
Galileo	E1B/C, E5b
BeiDou	B1I, B2I
QZSS	L1C/A, L1S, L2C
SBAS	L1C/A

RTK network

RTK data protocols	RTCM v3.3
Network RTK protocols	VRS, FKP, iMAX, MAC (RTCM SC 104)

Instrument channels

Depending on the satellite systems and signals configured, a maximum number of 184 channels is allocated.

Accuracy

Centimeter level accuracy⁶⁾

In this release the pointcloud cannot yet be geo-referenced.

⁵⁾ 400 m above sea level

⁶⁾ Accuracy is dependent upon various factors including the number of satellites tracked, constellation geometry, observation time, ephemeris accuracy, ionospheric disturbance, multipath and resolved ambiguities.

LiDAR and imaging

Type	Details
Laser class	1 (in accordance with IEC 60825-1)
Wavelength	830 nm
Field of view	Vertical: 360° Horizontal: 270°
Scan range	Min. 0.5 m, up to 25 m
Point measurement rate	420,000 pts/sec
Vision system	5-camera system, 1.6 MP each, total FoV 300° × 180°, global shutter

Autonomy

Type	Details
Obstacle avoidance coverage	Full spherical, 360°
Obstacle avoidance min. distance	3.5 m
Obstacle avoidance: Undetectable objects	Cables < 5 mm diameter. Radar does not reliably detect very thin objects like cardboard or small tree branches. It might miss glossy, transparent or dark surfaces.

System performance, SLAM based

Type	Details
Relative accuracy	< 20 mm ⁷⁾
Absolute accuracy, w/o GNSS	40 mm ⁸⁾
Area coverage: Vertical	1550 m ² in 12 min. (0.5 pts/cm ²) 4700 m ² in 12 min. (0.17 pts/cm ²)
Area coverage: Horizontal	1350 m ² in 12 min. (0.5 pts/cm ²) 4100 m ² in 12 min. (0.17 pts/cm ²)

Communication

Type	Data
Communication port	USB 3.1
Storage	Internal storage 256 GB
GNSS	Fully integrated
LTE - Radio ⁹⁾	Fully integrated, receive, external antenna, 403 to 470 MHz
BLE - Bluetooth Low Energy	Fast pairing between BLK2FLY and Apple iPad

⁷⁾ Concrete/brick surface

⁸⁾ 4 m distance from object, 2 m/s flying speed, 8 min flight, concrete/brick surface

⁹⁾ For real-time correction services

Type	Data
WLAN	<ul style="list-style-type: none"> • Video streaming, Live View on the Apple iPad • Control link to navigate the BLK2FLY by the Apple iPad • Data offload from the BLK2FLY to the Cloud

Data processing

Type	Details
Data transfer	Wireless: WLAN/LTE and USB 3.1 (USB C)
Desktop software compatibility	Leica Cyclone REGISTER 360 Leica Cyclone REGISTER 360 (BLK EDITION)
Supported data processing software	Leica Infinity and 3 rd party software (after geotagging the images in Infinity)
Cloud solution	HxDR: Hexagon Digital Reality (direct upload WLAN and LTE)

14.2

Smart Battery GEB374

Smart Battery GEB374

Cell type	LiPo (Lithium-Ion-Polymer)
Number of cells	4
Nominal voltage [V]	14.8
Nominal capacity [Ah]	6.75
Nominal energy [Wh]	99.9
Communication interface	UART on battery connector
Recommended storage temperature [°C]	+20 to +25

14.3

Tablet

Apple iPad

Type	Details
Application on Apple iPad	BLK2FLY Live Supporting LTE connectivity (iOS 12 or later). Including: flight planning, live 2D and 3D visualisation, device status and data management
Communication	WLAN / LTE / Bluetooth (pairing only)
WLAN frequencies	2.4 Ghz access point (flight operation) 5 GHz client (offload operation)
Max./typical transmission distance	WLAN: 100 m, line of sight LTE: depends on network
Internal memory	256 GB or around 5.25 h of scanning data
Brightness – High	1000 cd/m ²
Operating system	iOS 13 or later

BLK2FLY CE

- when it has to be right 



EU Declaration of Conformity

This corresponds to EN ISO/IEC 17050-1

We,

Leica Geosystems AG, CH-9435 Heerbrugg (Switzerland)

declare under our sole responsibility that the product

BLK2FLY

following the provisions of Directive(s)

- Directive 2011/65/EU**
(incl. delegated directive 2015/863 amending Annex II to Directive 2011/65/EU)
- Directive 2014/53/EU**
(in accordance with annex III, Module B of the Directive 2014/53/EU)
(EU-Type Examination Certificate G0M-2011-9488-V0x)
Notified Body 0681: Eurofins Product Service GmbH, Storkower Straße 38c, 15526 Reichenwalde, Germany
- Directive 2006/42/EU**

to which this declaration relates is in conformity with the following standards

- | | |
|-------------------------|-----------------------|
| EN 62311:2008 | EN 301 489-1 V2.2.3 |
| EN 61010-1:2010+A1:2016 | EN 301 489-3 V2.1.1 |
| EN 60825-1:2014 | EN 301 489-17 V3.2.2 |
| CISPR 32:2015 | EN 301 489-19 V2.1.1 |
| | EN 301 489-52 V1.1.1 |
| | EN 303 413 V1.1.1 |
| | EN 300 328 V2.2.2 |
| | EN 301 893 V2.1.1 |
| | EN 301 908-1 V13.1.1 |
| | EN 301 908-2 V11.1.1 |
| | EN 301 908-13 V11.1.1 |
| | EN 305 550-2 V1.2.1 |



Leica Geosystems AG, [mmm dd, yyyy]

Hannes Juen
Director Global Quality Engineering

Translation into the official EU languages please see www.leica-geosystems.com/about-us/compliance-standards/conformity-declarations

Leica Geosystems AG
Heinrich-Wild-Strasse
CH-9435 Heerbrugg
Switzerland
Phone +41 71 727 31 31
www.leica-geosystems.com

210082QE Leica BLK2FLY CE V2.docx

14.5

Conformity to National Regulations

14.5.1

Labelling

Labelling BLK2FLY



22340_001

14.5.2

BLK2FLY Aircraft

Frequency bands

Radio technology	Frequency band [MHz]
Bluetooth BLE (0–39)	2400–2483.5
WLAN	2.4 GHz (1–11)
	5 GHz (36, 38, 40, 42, 44, 48, 52, 54, 56, 58, 60, 62, 64, 100, 102, 104, 106, 108, 110, 112, 116, 118, 120, 122, 124, 126, 128, 132, 134, 136, 140)
UMTS	UMTS (FDD I) UL: 1950, DL: 2140
	UMTS (FDD II) UL: 1880, DL: 1960
	UMTS (FDD IV) UL: 1732.5, DL: 2132.5
	UMTS (FDD V) UL: 836.5, DL: 881.5
	UMTS (FDD VIII) UL: 897.5, DL: 942.5
	UMTS (FDD IX) UL: 1767.4, DL: 1862.4
LTE	LTE (FDD 1) UL: 1920–1980, DL: 2110–2170
	LTE (FDD 2) UL: 1850–1910, DL: 1930–1990
	LTE (FDD 3) UL: 1710–1785, DL: 1805–1880
	LTE (FDD 4) UL: 1710–1755, DL: 2110–2155
	LTE (FDD 5) UL: 824–849, DL: 869–894
	LTE (FDD 7) UL: 2500–2570, DL: 2650–2690
	LTE (FDD 8) UL: 880–915, DL: 925–960
	LTE (FDD 9) UL: 1749.9–1784.9, DL: 1844.9–1879.9

Radio technology	Frequency band [MHz]
LTE (FDD 12)	UL: 698-718, DL: 728-746
LTE (FDD 13)	UL: 777-787, DL: 746-756
LTE (FDD 18)	UL: 815-830, DL: 860-875
LTE (FDD 19)	UL: 830-845, DL: 875-890
LTE (FDD 20)	UL: 832-862, DL: 791-821
LTE (FDD 26)	UL: 814-849, DL: 859-894
LTE (FDD 28)	UL: 703-748, DL: 758-803
LTE (FDD 29)	UL: n/a, DL: 717-728
LTE (FDD 66)	UL: 1710-1780, DL: 2110-2200
LTE (TDD 41)	2496-2690
Radar	F1N (Sweep)
	60100-63900
GNSS	GPS
	L1 C/A 1575.42
	GPS
	L2 C 1227.6
	GLONASS
	L1 C/A 1598.0625 - 1609.3125
	GLONASS
	L2 C 1242.9375 - 1251.6875
	Galileo
	E1 1575.42
	Galileo
	E5b 1207.14
	BeiDou
	B1I 1561.098
	BeiDou
	B2I 1207.14
	SBAS
	L1 1575.42
	QZSS
	L1 C/A 1575.42
	QZSS
	L2C 1227.6

Output power

Radio technology	Output power [dBm] [Conducted]	
Bluetooth BLE (0-39)	6	
WLAN	2.4 GHz (1-11, OFDM, 1SS)	13
	2.4 GHz (1-11, HT20, 1SS)	13
	2.4 GHz (1-11, OFDM, 2SS)	10
	2.4 GHz (1-11, HT40, 1SS)	13
	2.4 GHz (1-11, HT40, 2SS)	10
	5 GHz (36-64, OFDM, 1SS)	10
	5 GHz (100-144, OFDM, 1SS)	13
	5 GHz (36-64, HT20, 1SS)	10
	5 GHz (36-64, HT20, 2SS)	10
	5 GHz (36-64, HT40, 1SS)	10
	5 GHz (36-64, HT40, 2SS)	10
	5 GHz (100-144, HT20, 1SS)	13
	5 GHz (100-144, HT20, 2SS)	13

Radio technology		Output power [dBm] [Conducted]
	5 GHz (100–144, HT40, 1SS)	13
	5 GHz (100–144, HT40, 2SS)	13
	5 GHz (36–64, VHT20, 1SS)	10
	5 GHz (36–64, VHT20, 2SS)	10
	5 GHz (36–64, VHT40, 1SS)	10
	5 GHz (36–64, VHT40, 2SS)	10
	5 GHz (36–64, VHT80, 1SS)	10
	5 GHz (36–64, VHT80, 2SS)	10
	5 GHz (100–144, VHT20, 1SS)	16
	5 GHz (100–144, VHT20, 2SS)	13
	5 GHz (100–144, VHT40, 1SS)	16
	5 GHz (100–144, VHT40, 2SS)	13
	5 GHz (100–144, VHT80, 1SS)	16
	5 GHz (100–144, VHT80, 2SS)	13
UMTS	UMTS (FDD, all)	23 (±1)
LTE	LTE (FDD, all)	23 (±1)
	LTE (TDD, all)	22 (±1)
Radar	601000–63900	8

Rated antenna gain

Radio technology	Frequency band [MHz]	Peak gain [dBi]
Bluetooth	2400–2483.5	3.5
WLAN	2401–2473	3.5
	5170–5710	4.8
UMTS	UMTS (FDD I)	3.6
	UMTS (FDD II)	3.8
	UMTS (FDD IV)	2.3
	UMTS (FDD V)	3.0
	UMTS (FDD VIII)	2.3
	UMTS (FDD IX)	1.7
	LTE	LTE (FDD 1)
LTE (FDD 2)		3.8
LTE (FDD 3)		2.3
LTE (FDD 4)		2.3
LTE (FDD 5)		3.0
LTE (FDD 7)		2.5
LTE (FDD 8)		2.3
LTE (FDD 9)		1.7
LTE (FDD 12)		1.0

Radio technology	Frequency band [MHz]	Peak gain [dBi]
	LTE (FDD 13)	2.2
	LTE (FDD 18)	2.8
	LTE (FDD 19)	3.0
	LTE (FDD 20)	3.1
	LTE (FDD 26)	3.0
	LTE (FDD 28)	1.2
	LTE (FDD 29)	RX only
	LTE (FDD 66)	2.3
	LTE (TDD 41)	3.0
Radar	60100–63900	8.1

Europe



Hereby, Leica Geosystems AG declares that the radio equipment type BLK2FLY is in compliance with Directive 2014/53/EU and other applicable European Directives.

USA

FCC ID: RFD-BLK2FLY
FCC Part 15

This device complies with part 15 of the FCC Rules. Operation is subject to the following two conditions:

1. This device may not cause harmful interference, and
2. This device must accept any interference received, including interference that may cause undesired operation.

This equipment has been tested and found to comply with the limits for a Class B digital device, pursuant to part 15 of the FCC Rules.

These limits are designed to provide reasonable protection against harmful interference in a residential installation.

This equipment generates, uses, and can radiate radio frequency energy and, if not installed and used in accordance with the instructions, it may cause harmful interference to radio communications.

However, there is no guarantee that interference does not occur in a particular installation.

If this equipment does cause harmful interference to radio or television reception, which can be determined by turning the equipment off and on, the user is encouraged to try to correct the interference by one or more of the following measures:

- Reorient or relocate the receiving antenna.
- Increase the separation between the equipment and the receiver.
- Connect the equipment into an outlet on a circuit different from that to which the receiver is connected.
- Consult the dealer or an experienced radio/TV technician for help.

Changes or modifications not expressly approved by Leica Geosystems for compliance could void the user's authority to operate the equipment.

Leica's Ictos device integrated in the BLK2FLY (938405) is certified and must be operated in accordance with the following requirements of the FCC Waiver DA 20-795 (Section 10):

1. The Leica Ictos device is certified for compliance with all the technical specifications applicable to operation under 47 CFR part 15, with the exception of the following provisions in: 1) 47 CFR § 15.255(a)(2), which is waived to allow the device to operate under the provisions of 47 CFR § 15.255 as a mobile field disturbance sensor;
2. 47 CFR § 15.255(b)(2), which is waived to allow the device to operate on-board a UA while not being part of a closed, exclusive on-board communication networks within the aircraft; and 3) 47 CFR § 15.255(c)(3), which is waived to allow the device to operate in the 60-64 GHz band at a maximum +19 dBm peak EIRP.
3. The Leica Ictos device is installed to transmit on a horizontal plane with respect to the UA on which it is mounted to limit emissions above the horizon. Operation is limited to line-of-sight only.
4. The Leica Ictos device comply with the following technical characteristics: a) intentional emissions will be contained to the 60-64 GHz band; b) out-of-band emissions will not exceed -51.3 dBm EIRP/MHz; c) transmit duty cycle will not exceed 50% over any 40 milliseconds interval; and d) transmission will occur only when the device is in motion.
5. Leica Ictos devices is allowed to operate below a maximum altitude of 400 feet above ground level, unless the small unmanned aircraft: (1) is flown within a 400-foot radius of a structure; and (2) does not fly higher than 400 feet above the structure's immediate uppermost limit.
6. U.S. sales will not exceed 400 Leica Ictos devices in the first year and up to 800 per year for subsequent years. The Leica Ictos device is not be marketed for retail consumer markets.
7. This waiver and its conditions apply only to the Leica Ictos device installed on a UA as described herein and are not to be considered to apply generally to other field disturbance sensors or radars. A copy of this Order will be provided with the application for certification of the Leica Ictos device.

Others

The conformity for countries with other national regulations has to be approved prior to use and operation.

14.6

Dangerous Goods Regulations

Dangerous Goods Regulations

Many products of Leica Geosystems are powered by Lithium batteries.

Lithium batteries can be dangerous under certain conditions and can pose a safety hazard. In certain conditions, Lithium batteries can overheat and ignite.



When carrying or shipping your Leica product with Lithium batteries onboard a commercial aircraft, you must do so in accordance with the **IATA Dangerous Goods Regulations**.



Leica Geosystems has developed **Guidelines** on "How to carry Leica products" and "How to ship Leica products" with Lithium batteries. Before any transportation of a Leica product, we ask you to consult these guidelines on our web page ([IATA Lithium Batteries](#)) to ensure that you are in accordance with the IATA Dangerous Goods Regulations and that the Leica products can be transported correctly.



Damaged or defective batteries are prohibited from being carried or transported onboard any aircraft. Therefore, ensure that the condition of any battery is safe for transportation.

DRAFT

Software Licence Agreement

This product contains software that is preinstalled on the product, or that is supplied to you on a data carrier medium, or that can be downloaded by you online according to prior authorisation from Leica Geosystems. Such software is protected by copyright and other laws and its use is defined and regulated by the Leica Geosystems Software Licence Agreement, which covers aspects such as, but not limited to, Scope of the Licence, Warranty, Intellectual Property Rights, Limitation of Liability, Exclusion of other Assurances, Governing Law and Place of Jurisdiction. Please make sure, that at any time you fully comply with the terms and conditions of the Leica Geosystems Software Licence Agreement.

Such agreement is provided together with all products and can also be referred to and downloaded at the Leica Geosystems home page at [Hexagon – Legal Documents](#) or collected from your Leica Geosystems distributor.

You must not install or use the software unless you have read and accepted the terms and conditions of the Leica Geosystems Software Licence Agreement. Installation or use of the software or any part thereof, is deemed to be an acceptance of all the terms and conditions of such Licence Agreement. If you do not agree to all or some of the terms of such Licence Agreement, you must not download, install or use the software and you must return the unused software together with its accompanying documentation and the purchase receipt to the distributor from whom you purchased the product within ten (10) days of purchase to obtain a full refund of the purchase price.

DRAFT

947309-1.1.0en

Original text

Printed in Switzerland, © 2022 Leica Geosystems AG



- when it has to be **right**



Leica Geosystems AG

Heinrich-Wild-Strasse
9435 Heerbrugg
Switzerland

www.leica-geosystems.com

