

# Bugs 8 Pro



PROFESSIONAL RTF RACING DRONE

## Instruction Manual



Brushless motor  
(2204 1800KV)



4-in-1 ESC  
(stuck and high-  
temperature protection)



Two-direction 2.4GHZ  
(weak signal and low voltage  
remote controller alarm)

# Important statement and safety guidelines

---

Thank you for purchasing MJX product. Please read this manual carefully before use and retain it for future reference.

## Important statement

- This aircraft is not a toy, but hobby grade model. It should be assembled and operated properly. Pilot must operate this hobby model in safe way. Improper operation may cause injury or property damage.
- This aircraft is applicable for pilots aged 14+ who are with skilled flying experience.
- Users are in full charge of proper operating this aircraft. Manufacturer and dealers disclaim any responsibility for damages caused by misuse.
- Keep the small accessories away from kids to avoid accident.

## Flight safety guidelines

Hobby grade radio control aircraft is somewhat considered to be the highest danger potential article. Users should firmly uphold the principle of “safety comes first”. Never fly the aircraft near airports, above crowds or in zones storing dangerous goods and understand the responsibility of the accident may cause by improper operations.

### • Stay away from obstacles, crowds, power lines, trees or waters

Always choose a wide open area for every flight, well away from people and property. Never fly directly over people or animals. Please don't fly in such bad weather conditions as high temperature, snow, strong wind ( $\geq$ level 5), rain or fog. Maintain a 7ft (2m) distance from the aircraft when taking off and landing.

### • Keep the aircraft in dry environment

The aircraft is composed by sophisticated electronic components and mechanical parts. To avoid damages on the mechanical and electronic components, please keep the aircraft in dry environment and use clean cloth to wipe the surface and keep it clean.

### • Practice flying together with skillful pilot

Beginners are suggested to practice flying together with skillful pilot's guidance. Do not fly alone.

## ● Bear proper operation and safe flight guidelines in mind

Please take a careful look at the manuals before flights for important information of product functions and operation tips, and learn how to use the accessory, safe flight always comes first. Stay informed of and abide strictly by relevant local laws and regulations. Keep away from any non-flight zones and respect other people's privacy.

## ● Safe flying

Please make sure you are in good shape mentally before every flight. Fly the aircraft as per your flying experience. Never fly under influence of alcohol or drugs. Keep the remote controller at least 20 cm away from your body when flying the aircraft.

## ● Keep distance from a flying aircraft

Never use your hands to touch a flying aircraft under any circumstance. Don't approach and touch a landed aircraft before its propellers are completely locked.

## ● Keep away from heat source

The aircraft is made of metal, fiber, plastic, electronic component and other material. Please keep it away from the heat source to avoid deformation or even damage caused by sun exposure and high temperature.

## ● Environmental protection requirements

To protect our blue planet, so please recycle the aircraft as per local laws and regulations.

# Product profile

---

## Product configuration

### Package includes:

Aircraft (camera not included) x1      Extra Propellers A/B x2      Propeller changing tool x1  
Screwdriver x1      Power adaptor x1      Balance charger x1      Remote controller x1      Battery x1  
Silicone rubber ring x4      Jumper wire cap x1

### Technical parameter of the aircraft

Diagonal: 250mm      Overall height: 90mm      Brushless motor: 2204 1800KV  
Gross Weight: about 420g      Battery: 11.1V 1300 mAh      Charging time: around 150 minutes  
Maximum flying time: about 10 minutes

# Product assemble

## Propellers installation/removal

### How to install propeller A:

Put the propeller with marking 'A' into the clockwise rotating motor shaft (the side marked A should be upwards). Then, put the silicone rubber ring into the center bore of the propeller. Last, choose the propeller screw with dot and put it onto the motor shaft; tighten the screws by counter-clockwise.

### How to install propeller B:

Put the propeller with marking 'B' into the counter-clockwise rotating motor shaft (the side marked B should be upwards). Then, put the silicone rubber ring into the center bore of the propeller. Last, choose the propeller screw without dot and put it onto the motor shaft; tighten the screw by clockwise.

### How to remove the propeller

Hold the aircraft brushless motor and unscrew the screw without dot by counter-clockwise (screw with dot should be rotated by clockwise) to take apart the propeller.

**⚠ Attention:** Please install all fittings step by step as below pictures. Keep in mind that the propellers are distinguished by A & B mark and propellers screws are distinguished by dot mark. Please pay attention to your rotation direction.

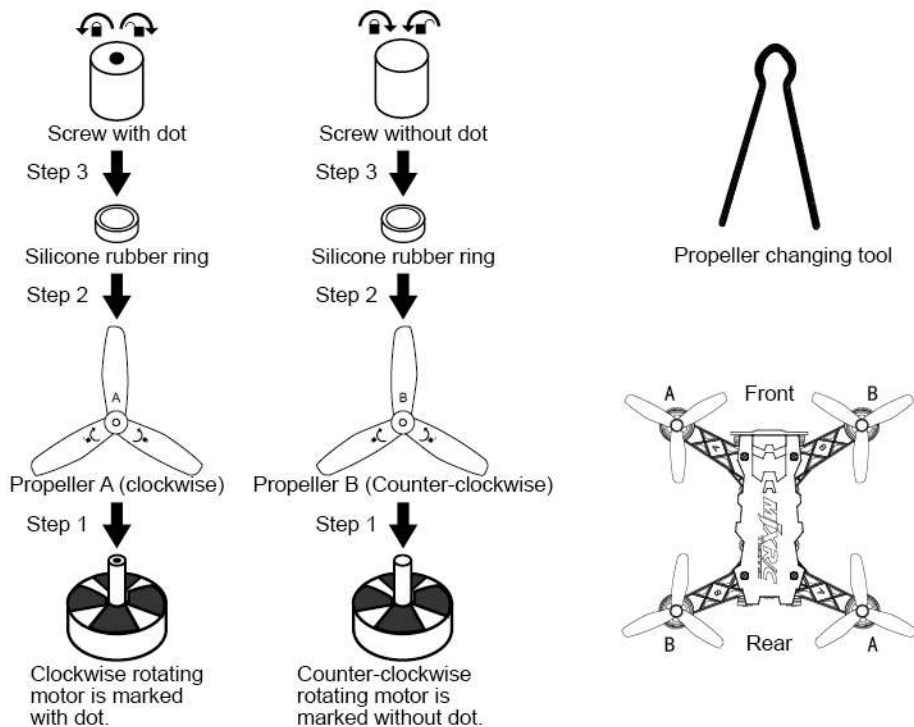

- ⚠**
- Please make sure that the clockwise and the counter-clockwise propellers are installed on the correct motors, because the aircraft will not fly normally for wrong propellers installation.
  - Be careful when installing the propellers, as they are a little sharp.
  - Please use MJX propellers for this aircraft.
  - Extra propellers can be ordered additionally.

## Battery installation

Insert the battery into the battery compartment and make sure the battery is installed in place. Then, insert the power plug of the battery into the power socket locating at the rear of the aircraft.

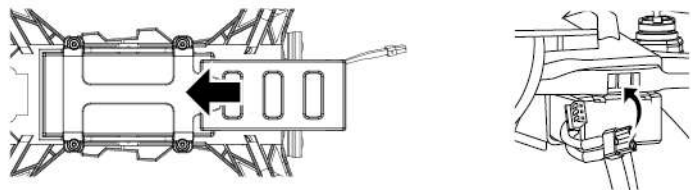

**⚠ Note:** Please connect the power plug as per the indicated positive and negative polarity.

## How to install the battery of remote controller

Open the battery door, install 4\*AA batteries into the battery compartment according to the given polarity and then close the battery compartment.

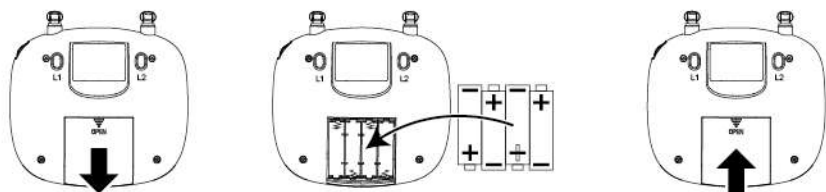

- ⚠**
- Insert batteries with correct polarity.
  - Non rechargeable batteries are not to be charged; the transmitter need 4\*AA batteries for work.
  - Do not mix old and new batteries.
  - Do not mix alkaline, standard (carbon-zinc), or rechargeable (nickel-cadmium) batteries.
  - Rechargeable batteries are to be removed from the aircraft before being charged;
  - Rechargeable batteries are only to be charged under adult supervision;
  - Exhausted batteries are to be removed from the aircraft;
  - The supply terminals are not to be short-circuited.

## How to charge the battery of aircraft

Plug the adaptor into power outlet; then, connect the adaptor cable with the balance charger; finally, insert the white quadruplex-wire plug of the battery into the quadruplex-wire socket of balance charger. When charging is proceeding, the green light keeps flashing and the red keeps solid on; when charging is finished, both of the green light and the red light keep solid on. If battery wire is not connected with the balance charger, but the balance charger is connected with the adaptor, the red light is on and the green light is off. Full charging time takes about 150 minutes.

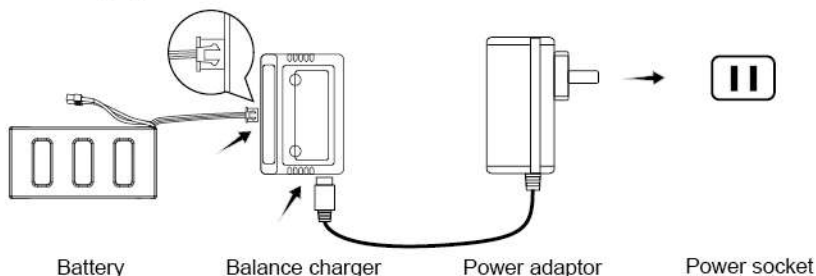



Warnings: We recommend using MJX adaptor for charging.



- Need adult supervision when this aircraft is being played by children.
- Only batteries of the same or equivalent type as recommended are to be used.
- Insert batteries with correct polarity.
- Non rechargeable batteries are not to be charged; the transmitter need 4\*AA batteries for work.
- Do not mix old and new batteries.
- Do not mix alkaline, standard (carbon-zinc), or rechargeable (nickel-cadmium) batteries.
- Rechargeable batteries are to be removed from the aircraft before being charged.
- Rechargeable batteries are only to be charged under adult supervision.
- Exhausted batteries are to be removed from the aircraft.
- The supply terminals are not to be short-circuited.
- The charging line to be used with the product should be regularly examined for potential hazard, such as damage to the cable or cord, plug, enclosure of other parts and that in the event of such damage, the product must not be used until that damage had been properly removed.

## Major parts of the aircraft

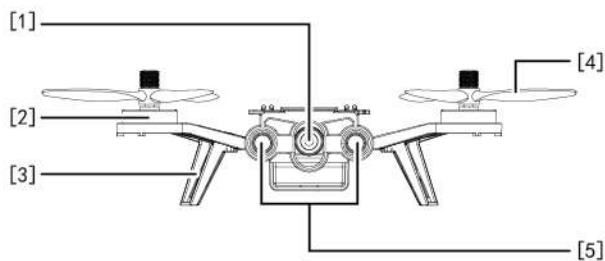

- [1] Camera C5830 (Optional)
- [2] Brushless motor
- [3] Undercarriage
- [4] Propeller
- [5] Front light

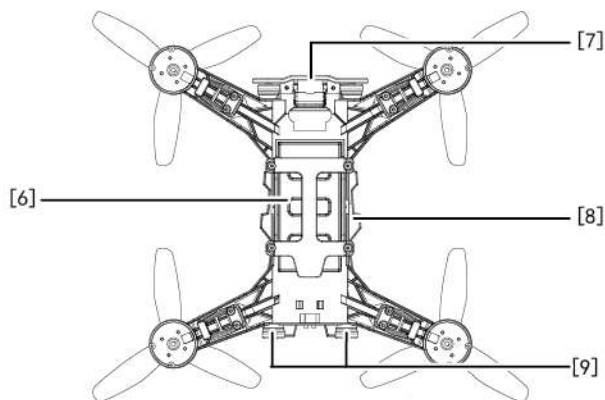

- [6] Battery compartment
- [7] Front cover
- [8] Upper cover
- [9] Rear light

## Major parts of the remote controller

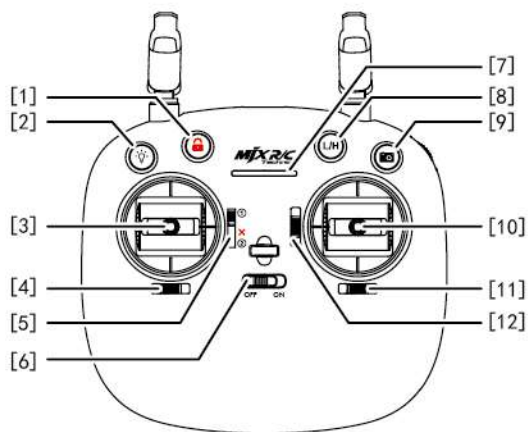

- [1] Unlock (short-press)/lock (long-press)
- [2] Light switch
- [3] Left stick
- [4] Turn left/right trimmer
- [5] Angle mode/Acro mode
- [6] Power switch
- [7] Power indicator
- [8] High/Low speed switch
- [9] Photo/shooting
- [10] Right stick
- [11] Leftward/rightward flight trimmer
- [12] Forward/backward trimmer

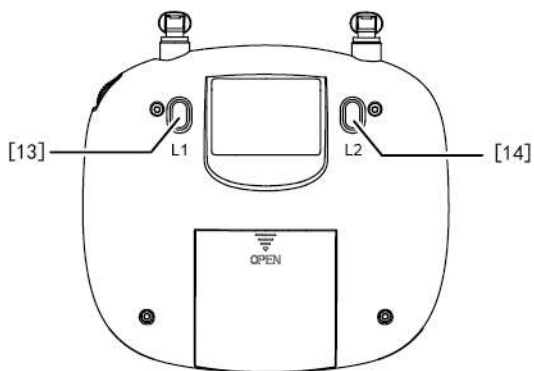

- [13] 3D flips & rolls button
- [14] Null button

## Remote controller

### How to connect the signal of the aircraft with the remote controller

- Keep pressing the red button and turn on the remote controller. The remote controller makes 2 beep sounds, and the indicator light keeps flashing; the remote controller is under signal connection status.
- Turn on the aircraft. The aircraft will make beep sounds with rear lights flashing and the aircraft automatically links to the remote controller. Once the aircraft rear lights turn from flashing to off, it means that signal connection is succeeded. (Place the aircraft on the flat ground when proceeding signal connection.)

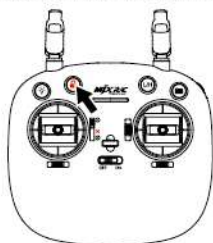

- 
- ⚠** • Signal connection is done once for all if the remote controller is not linked to other aircraft.
- Set the connection one by one to avoid signal connection error.
- 

## Remote controller control stick calibration

1. Keep pressing the red locking button and turn on the remote controller.
2. Push down the calibration button (shown as pic.1) and hold on for 3 seconds, the remote controller will make 3 beep sounds and the indicator light of the remote controller turns from flashing quickly to slowly. Maximum rotate both of the left and right control stick to any direction for 2 circles (shown as pic.2).
3. Then, again, push down the calibration button and hold on for 3 seconds. The remote controller will send out 3 beep sounds and the indicator light of the remote controller turns from flashing slowly to quickly, which means that the control stick calibration is completed.

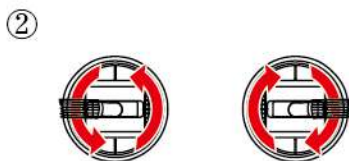
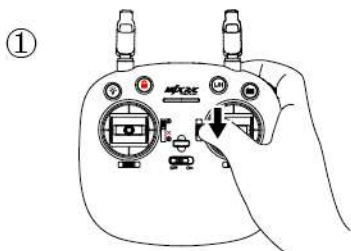

- 
- ⚠** Warm tips: All remote controllers have been calibrated when manufacturing. Remote controller calibration is requested only if pilots find that the remote controller control sticks are not working normally.
- Attention: Please do not power on your aircraft when calibrate the control stick for the remote controller.
- 

## Aircraft gyro calibration

After the aircraft and the remote controller are banded, set the aircraft on flat ground and follow the indication photo as below to calibrate the gyro. Once the aircraft rear lights turn from flashing quickly to off, it means that gyro calibration is succeeded.

- This is not compulsory step. But it is recommended to do gyro calibration for every flight to obtain best flight experience.





# How to lock and unlock the aircraft

## Unlock the aircraft

Once the aircraft and the remote controller are banded, the front lights of the aircraft keep solid on. Short-press the red button (indicated as below photo), the remote controller makes a long beep sound, and both the front and rear lights of the aircraft keep solid on. The motors rotate slowly, the aircraft is unlocked.

## Lock the aircraft

Method 1: Pull down the throttle stick to the bottom position, long-press the red button (indicated as below photo). The remote controller makes "Di...Di..." sound. After that, the motors stop rotating and the rear lights turn off, which means that the aircraft is locked.

Method 2: After the aircraft lands on the ground, pull down the throttle stick to the bottom position for 15 seconds; then, the motors stop rotating and the aircraft lock automatically. Once the aircraft is locked, it could not fly unless the motor is unlocked.

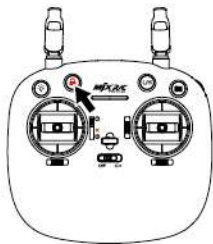

---

**⚠ Warnings:** The throttle control stick should be pushed to the bottom position when long-press the red button to lock the aircraft. Otherwise, the aircraft could not be locked.

---

# Angle Mode/Acro Mode

## Angle mode:

Angle mode, also named as self-level mode, is an assisted flight mode where the flight controller would always attempt to put the aircraft in its neutral position when there is no user control. This means that with your hands off the controls, it will use 6-axis gyroscope to keep the aircraft level. The aircraft can perform flips and rolls by pressing the rolls button and operating joystick. This is the default flight mode. It is suitable for beginner.

## Acro mode:

Acro mode, as known as rate mode, doesn't level the aircraft automatically but always requires manual control during flight. Acro mode uses only the 3-axis gyro sensor. This is the more difficult mode for flying but also much more responsive. Acro mode is great for acrobatics such as flips and rolls. The aircraft can perform flips and rolls by operating joystick. It requires that pilot should be skillful enough and beginner is not suitable for Acro mode.

● Please choose flight mode before turn on the remote controller.

## How to set Acro mode & Angle mode :

**Note:** The remote controller is set in Angle mode (factory default mode), which the jumper wire cap is not inserted into the PIN port locating on the flight-control board.

Step 1: Make sure that the remote controller and the aircraft are off. Plug the jumper wire cap into the PIN port locating the flight-control board (Pic.1);

Step 2: Plug the jumper wire cap into the PIN port located at the flight-control board (Pic.1); slide the flight mode button from position "①"(Angle mode) to position "②"(Acro mode) , the flight mode will change to Acro mode accordingly. Slide the flight mode button back to position "①", the flight mode will resume to Angle mode.

The aircraft flight mode could not be changed during flight. It is important to slide the button to the right position when choosing mode. "X" position is null, without function. Please be noted.

Step 3: Power on the remote controller and install the battery of the aircraft (Pic. 3).

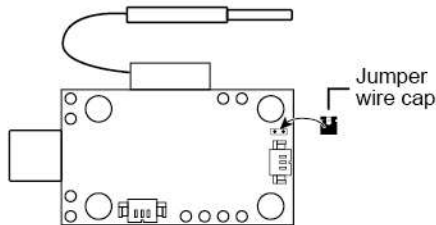

Pic.1



Pic.2



Pic.3

### ⚠ Warm tips:

- 1.The aircraft flight mode could not be changed during flight.
- 2.Please follow the above setting instruction step by step when setting Acro mode. Failure to do so, your aircraft will be always in angle mode.
- 3.Once the jumper wire cap is pulled out from the PIN port, re-set Acro mode is requested before every flight. Failure to do so, your aircraft will be always in angle mode.
- 4.If the jumper wire cap plug keeps connected and the flight mode button is remained at the position of "2"; then, once you turn on your aircraft, it is in Acro mode already.

## Operate the aircraft

Remote controller	Aircraft	Remote controller	Aircraft
	<p>Ascent</p> <p>Descent</p>		<p>Turn Right</p> <p>Turn Left</p> <p>Front</p> <p>Rear</p>
	<p>Backward</p> <p>Forward</p>		<p>Left Side Flight</p> <p>Right Side Flight</p> <p>Front</p> <p>Rear</p>

# Flips & rolls

## Flips & rolls operation

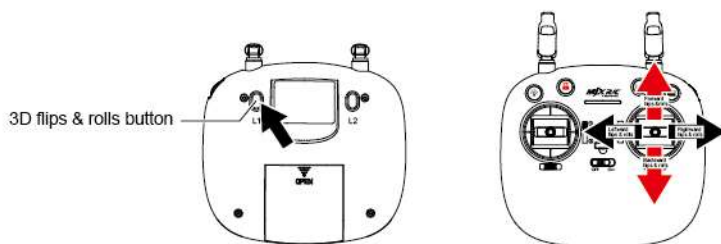
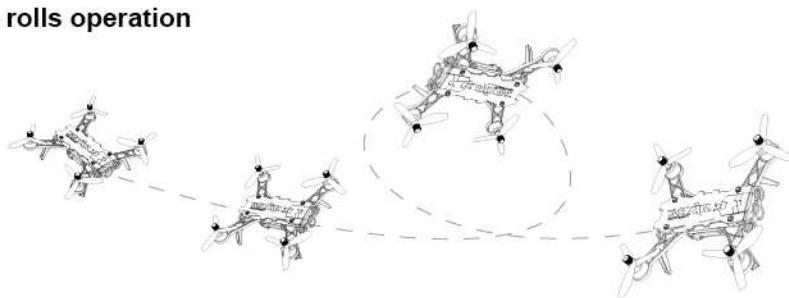

**⚠ Warm tips:** To flip and roll, please press down the 3D flips & rolls button and push the direction control stick at the same time. If not, the aircraft could not perform flips & rolls action normally.

## How to fine-tune the aircraft

If the aircraft keeps moving in any direction even this is no control signal given after flying, users may adjust the remote controller's trimmer button to keep the aircraft balance.

### Forward/backward trimmer

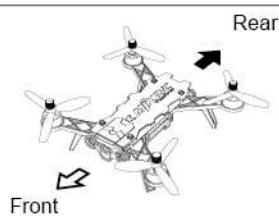

### Turn left/ turn right trimmer

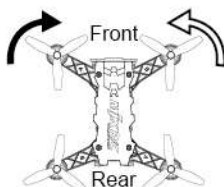
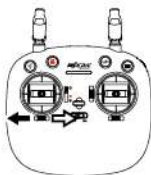

### Leftward/rightward trimmer

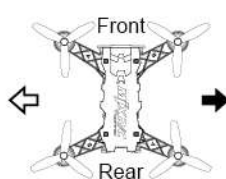
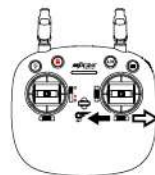

## Status indicator

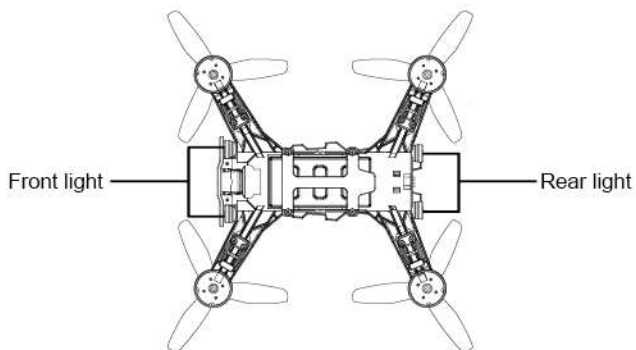

Sound of the aircraft	Status lights of the aircraft	Description
-	The rear lights flash quickly	The gyroscope is in the checking state , the aircraft is fail to connect the signal.
Send out continuous beep sound quickly	The rear lights flash once then turn on for 2 seconds	The signal of remote controller is lost after the aircraft received the signal from the remote controller.
Send out continuous beep sound slowly	The rear lights flash slowly	The aircraft is underpowered and the remote controller send out the sound "beep... beep... beep...".
-	The front lights turn on, and the rear lights turn off	The aircraft is under lock status.
-	The front lights power on/off	Turn on or turn off by the remote control.

## Remote controller power indicator light description

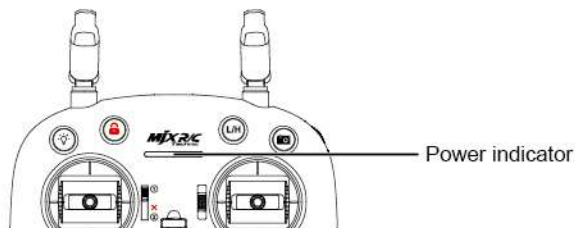

Remote controller sound	Power indicator	Description
Send out continuous beep sound quickly	On	1. The aircraft is too far away from the remote controller that resulted in weak receiving signal. 2. The aircraft is powered off after successful signal connection.
Send out continuous beep sound slowly	On	The aircraft is in low voltage status.
Send out a long beep sound only	On	The remote controller has connected with the aircraft successfully.
Send out "beep beep" sound continuously	Flashing slowly	The remote controller is under power.
Send out "beep" occasionally	On	The aircraft receives very weak signal from the remote controller.

# Flight

## Before you take off, check and make sure that

- 1.The aircraft and the remote controller are full charged.
- 2.The propellers are installed correctly.
- 3.The motors work normally after unlocking.

## Basic flight operations

### Basic flight operations step

- 1.Connect the remote controller with the aircraft.
- 2.Unlock the aircraft after the detection of gyro of the aircraft is completed.
- 3.Pull up the throttle stick then the aircraft takes off, and control the aircraft flight by left/right stick.
- 4.Push the throttle stick to the bottom, lock the aircraft by press the lock button for long time.
- 5.Take out the battery from the aircraft.

## Receiver PCB connecting diagram



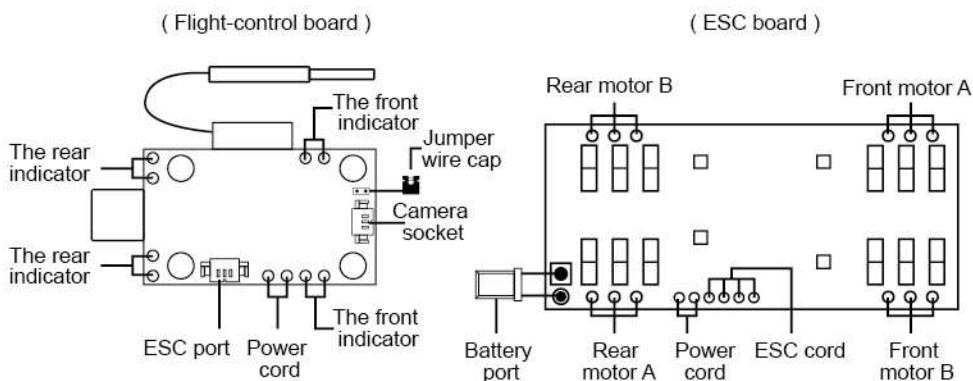













To make sure the aircraft works normally, the installation direction of the flight-control board and the connection location of the insertion wiring must be the same as shown below:



 Warnings: Please purchase MJX camera.

# Product components

## Basic parts

			
Upper cover B8PR01	Main frame B8PR02	Propeller A/B B8PR03	Screw without dot/ Screw with dot B8PR04
			
Battery door/Front cover B8PR05	Receiver PCB/ Jumper wire cap B8PR06	Clockwise motor B8PR07	Counter clockwise motor B8PR08
			
Battery B8PR09	Undercarriage B80005	Bolt/Antenna buckle/ Lamp cover ring/ Bolt buckle B80008	Lamp cover of the front and rear light B80009
			
Propeller changing tool B80010	ESC board B80012	Front/Rear light bar B80015	Silicone rubber ring B80017

			
Heat sink B80018	Screws pack B80019	Remote control GR6120B	

## Optional accessories

			
5.8G Receive screen 4.3-inch LCD Display D43	VR goggles G3	5.8G FPV Camera C5830	

## Trouble shooting

No.	Phenomenon	Solution
1	The lights are flashing quickly.	The Gyro of the aircraft is under signal detecting condition, set the aircraft to any flat surface.
2	The aircraft can't be kept balance after taking off and lean one side.	1) Adjust all trimmer buttons to the middle value. 2) Lay the aircraft in the flat surface or flat ground and proofread the gyro of the aircraft again.
3	The aircraft is shaking fiercely.	The rotor blade is out of shape, change the propellers.
4	The aircraft fail to unlocked, the rear indicator flash slowly.	The battery is under low power situation, please charge the battery full.
5	The aircraft can't be locked.	1) Push the throttle stick to the bottom first, then press the lock button for long time. 2) Proofread the stick of the remote control then push the throttle stick to the bottom, later press the lock button for long time.

Note:

- a) Changes or modifications not expressly approved by the party responsible for compliance could void the user's authority to operate the equipment.
- b) This equipment has been tested and found to comply with the limits for a Class B digital device, pursuant to part 15 of the FCC Rules. These limits are designed to provide reasonable protection against harmful interference in a residential installation. This equipment generates, uses and can radiate radio frequency energy and, if not installed and used in accordance with the instructions, may cause harmful interference to radio communications. However, there is no guarantee that interference will not occur in a particular installation. If this equipment does cause harmful interference to radio or television reception, which can be determined by turning the equipment off and on, the user is encouraged to try to correct the interference by one or more of the following measures:
- Reorient or relocate the receiving antenna.
  - Increase the separation between the equipment and receiver.
  - Connect the equipment into an outlet on a circuit different from that to which the receiver is connected.
  - Consult the dealer or an experienced radio/TV technician for help.

