

# Ninja Dragon Phantom Z Manual



# Important safety information

( 1 ) The product is not a toy, but the mechanical, electronic, aerodynamics, high-frequency transmission and other professional knowledge into one of the fine Dense equipment, the need for proper assembly and commissioning to avoid accidents. The product holder must use a safe way. Operation control: improper operation, may cause serious personal injury or property damage. We are not responsible for this. Because we can not control the assembly, use, operation process.

( 2 ) This product is suitable for people with operating model experience, the age of not less than 14 years of age.

( 3 ) The flight site must be a local legal remote control model flight site.

( 4 ) Once the product is sold, we will not be responsible for any safety and safety arising from operation and use, control, etc.

( 5 ) If any using, operating and measuring problems, please contact with local distributors, for we have assigned those distributors to provide technical support and after sales service.

## 2. Safety Precautions:

Remote control model aircraft is a high-risk goods, must be away from the crowd when flying. Artificial assembly or body damage, electronic control. Improper equipment, and operation are not familiar with, are likely to cause damage to the aircraft or personal injury and other unpredictable accidents. please. Pilots must pay attention to safety, and need to understand due to their own negligence caused by accidental responsibility.

( 1 ) Away from obstacles and crowds

The flight of the remote control flight has an uncertain flight speed and state, there is a potential risk. Fly away from the flight. People, high-rise buildings, high-voltage wires, etc., while avoiding wind and rain, thunderstorms and other bad weather flight to ensure that pilots, The surrounding population and the safety of the property.

( 2 ) Away from the damp environment

The interior of the aircraft is made up of many sophisticated electronic components and mechanical parts, so it is necessary to prevent the aircraft from wet or into the body, so as to avoid mechanical, electronic components failure caused by accidents!

( 3 ) Safe operation

Please operate the remote control aircraft according to your own status and flight skills. Fatigue, poor spirit or improper operation will increase. Probability of accidental risk.

( 4 ) Keep away from high-speed rotating parts

When the propeller in the high-speed flight, the pilot, the surrounding crowd and objects away from the rotating parts, so as to avoid danger and damage.

( 5 ) Keep away from heat

Remote control aircraft is composed of metal, fiber, plastic, electronic components and other materials, so as far as possible away from heat, to prevent day. Drying, to avoid deformation caused by high temperature or even damage.

---

## The plant is made of lithium polymer battery ( LiPo )

Lithium batteries are different from the general battery, which consists of a thin layer of thin paper wrapped with its chemical endoplasm. This can be great. To reduce its weight, but it makes it more vulnerable in the face of rough or inappropriate operations. Like the same. There is a battery, as inappropriate operation will cause a fire explosion.

 ● Do not put the battery in the model for charging, which may cause the battery to fire and damage you of the aircraft.

● If you plan to use this product for one week or more, keep the battery 50% Increase the battery life. Keep the battery 50% of the battery, just use the battery when fully charged Half of the time to charge.

● Please use the original professional charger to charge the battery.

● Do not charge the carpet to prevent fire.

● Lithium battery in the storage for more than three months after the need to charge to maintain the voltage to ensure that it should have Of life.

## Remote control and aircraft battery installation and charging instructions

Remote control battery installation:

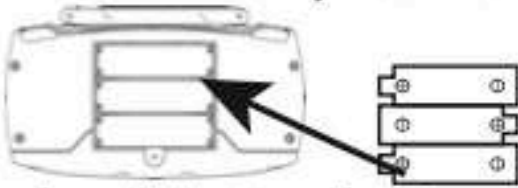

As shown in the figure according to the electrode box electrode instructions (+ / -)  
Place the battery correctly (as shown).

The aircraft battery is charged

1. Connect the USB cable to the computer to charge:  
USB charging end connected to the aircraft battery plug, the other end can be connected to the computer USB port to charge the battery, charging lights, full when the lights off.

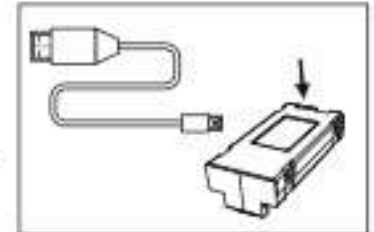

2. Connecting the aircraft power supply:

Put the charged battery into the battery holder of the aircraft, and then place the battery plug at the power supply on the vehicle Into the socket for power connection, connected to open the aircraft power, then the aircraft lights.

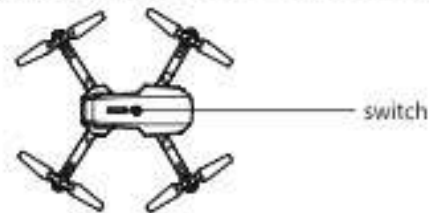
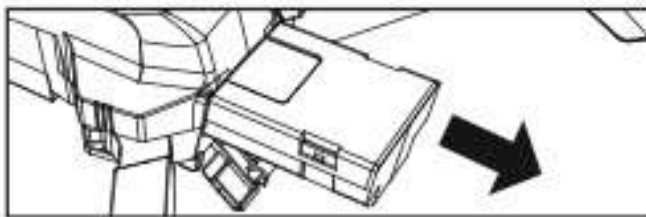

## Aircraft installation

1、 Folding function display

When folding, please fold the back  
Show arms, and then folded in front  
of the arm,Expand the opposite!

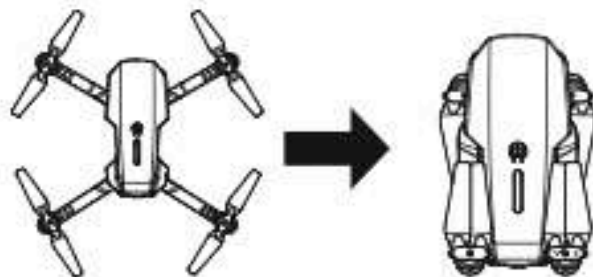

2、 Aircraft fan installation

Please follow the correct direction to install the propeller, propeller on the sign. Installed to the upper left corner of the aircraft and the lower right corner of the arm, with the phase. With the propeller on the sign B mounted to the upper right corner of the aircraft and the lower left corner of the arm, the installation of the fan folder when the alignment of the cone assembly Square accessories, installed in place after the locking screw!

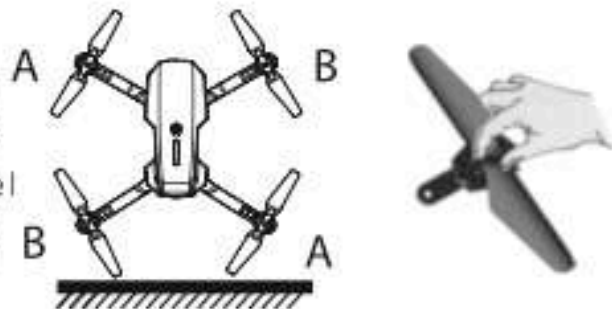

3、 Aircraft protection rack installation

The protective frame at the aircraft arm position (pictured) Install fastening.

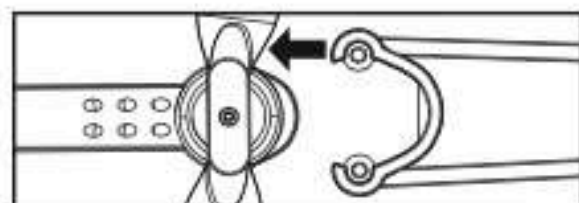

## Remote control function name

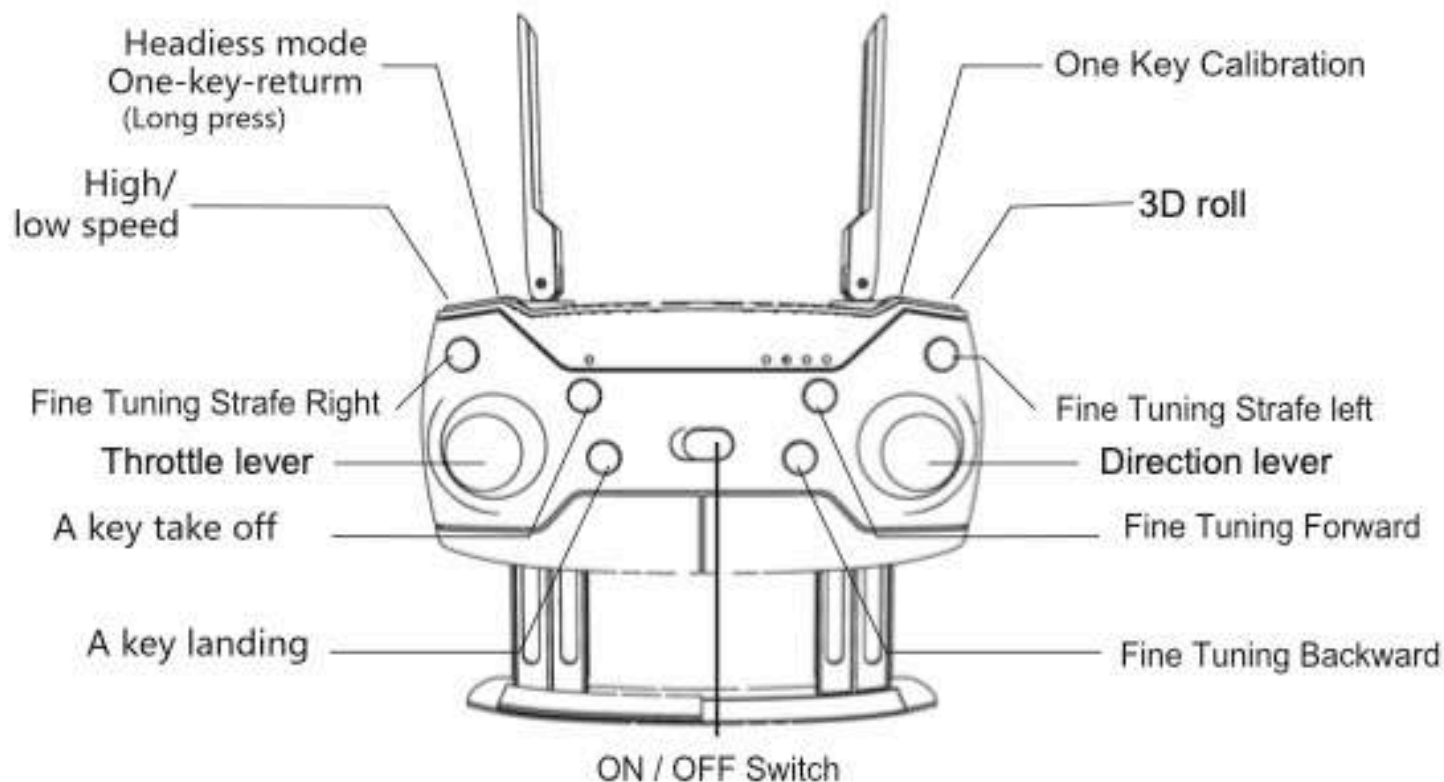

## Remote control

### 1、 Mobile phone rack

Pull out the remote control lower bracket, clamp the phone.

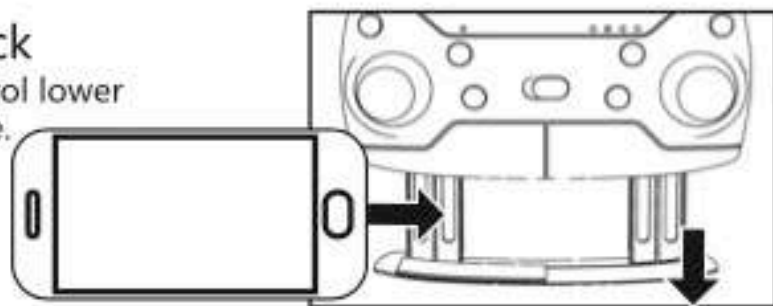

### 2、 2.4G frequency

Open the aircraft power switch, the aircraft placed in the flat Ground, then the aircraft indicator light flashes, open the remote control power source switch, the throttle joystick pushed to the highest after the pull to the lowest, Buzzer prompt "tick" sound! The aircraft indicator light is on, right Frequency to complete, then you can take off!

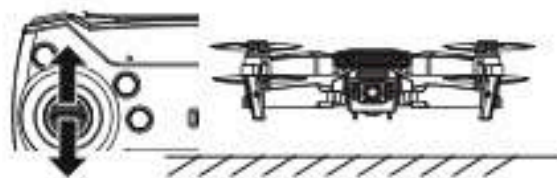

### 3、 A key to start and a key landing

Tip: This product is determined by the barometer. In a variety of environmental temperature and other factors, The aircraft will automatically start when flying or low voltage. Appear high and low changes are normal!

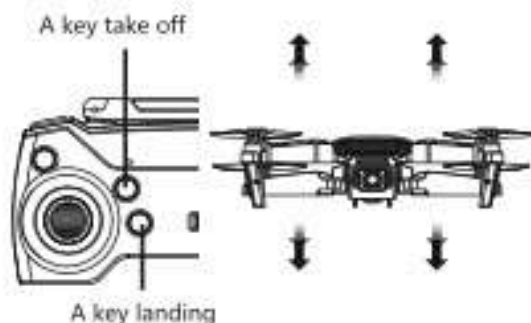

## 4、Flight control

### A.Throttle (left lever)



### B.Forward and backward (right lever) (with camera front side)

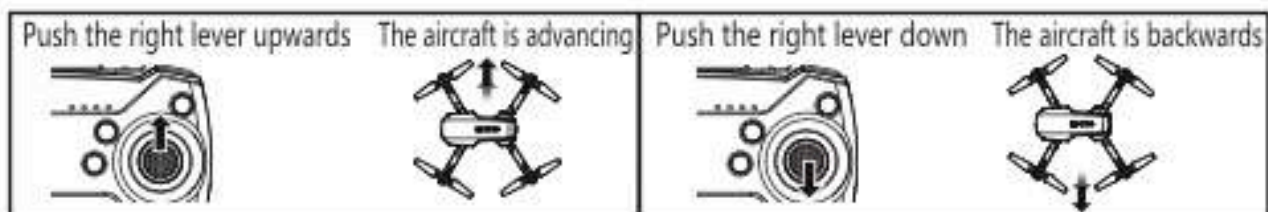

### C.Left and right side fly

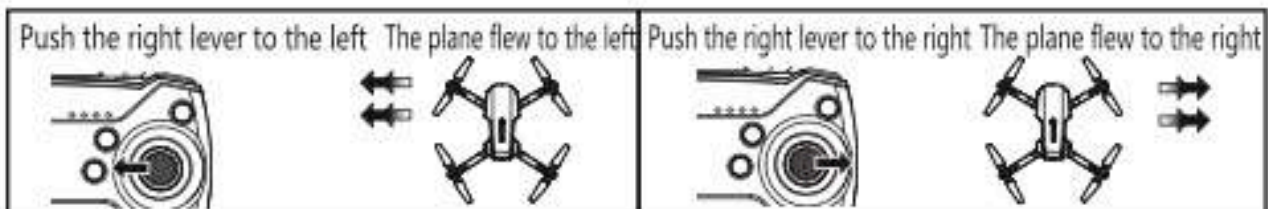

### D.Turn left and right (with camera front side)

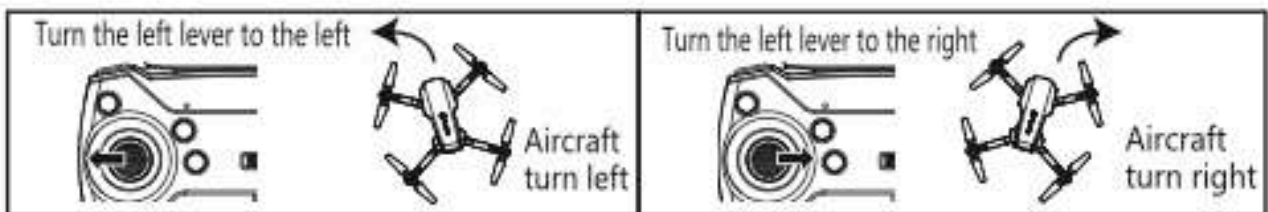

## 5、Fine-tuning control (with camera front side)

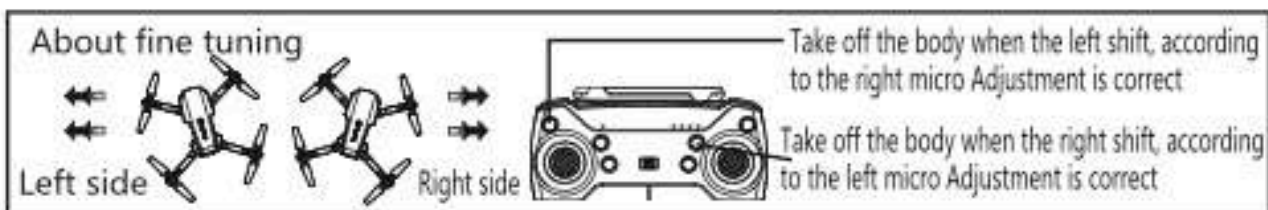
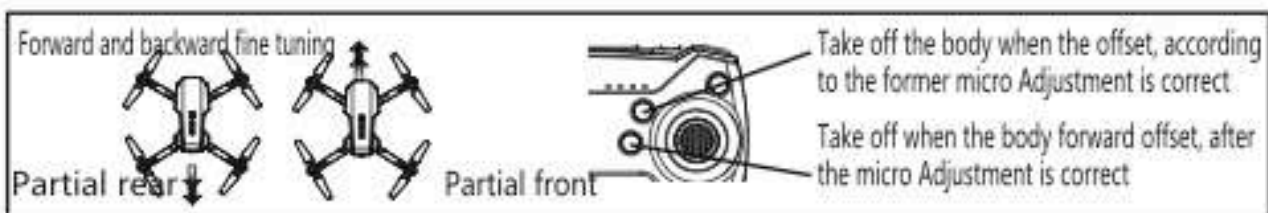

## Directional definition and mode selection of headless mode

When converting to headless mode, the aircraft will give up its front and rear azimuths, and reposition the front and rear with the remote control as a reference point. Such as: when the right lever to push forward, the aircraft will fly away from the remote control; when the right lever to pull back, the aircraft will fly to the remote control. (With camera front side)

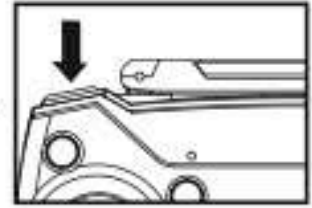

1. The direction of the aircraft before departure: the direction of the aircraft forward in front of you, (With the camera side for the front) remote control to the end of the direct flight and then press a key. Take off, that is, to complete the flight head mode direction definition.

2. When flying by the headless mode of the remote control issued a "flute, flute" twice, the aircraft lights Light flashing into the headless mode. And then press the remote control issued a "flute" sound Exit the headless mode.

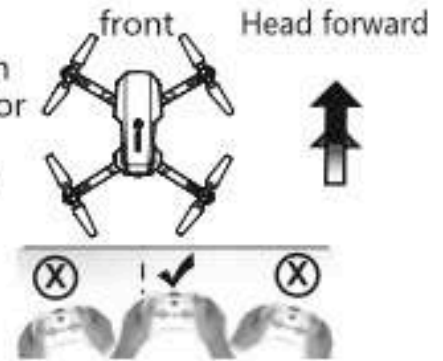

## A key return

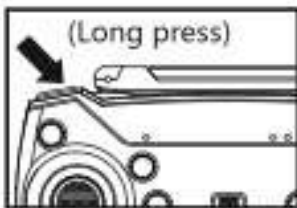

Press a key return, the aircraft will give up their own front and rear left and right direction, automatically defined by the headless mode of backward direction of flight, when the control of the right lever when the stop this function

\* Note: This feature can only be done automatically and the flight can not be reached automatically.

## Speed selection

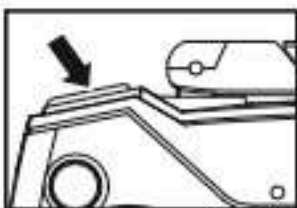

Speed file is to advance, back and left and right side of the flight is divided into third gear speed, the remote control is turned on by default when the slow power, press the remote control button issued a "flute" "flute" twice as midfielder, "flute" " " Flute "press three times for the fast file," flute "soon return to slow file.

(Recommended beginners with slow operation)

## One Key Calibration



Place the drone on the horizontal plane, press one key calibration to automatically correct the drone.

## Aircraft settings reset

When a novice operates this remote control aircraft, if the flight is unstable after takeoff and drifts rapidly in one direction, the gyroscope level correction function can be used to correct the aircraft. Method As shown in the figure, the aircraft is placed on the flat ground after the start-up frequency is completed, and The throttle lever and the directional lever are simultaneously angled to the bottom right corner, the buzzer emits a "drop" sound, and the aircraft lights shine long, indicating that the horizontal correction is completed.



### \* Emergency shutdown

1. If there is danger during the flight, you need to stop the emergency can be shown as shown, long press the roll button, the aircraft immediately stop running. This function does not attempt to operate when the aircraft is flying at normal altitude, and the non-side aircraft will fall quickly.
2. When the aircraft tilts more than 45 degrees, the aircraft will automatically stop protection.
3. When operating with APP, pull down the throttle and press a key stop button at the same time that is an emergency stop

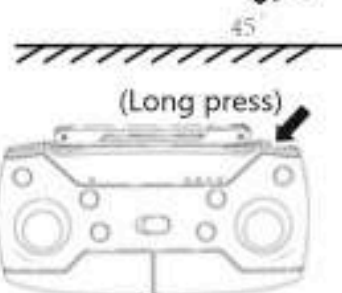

## Problem guide

Ask questions	The original for	Approach
Connect the flying saucer batteries and fly The indicator light on the dish continues Flicker, operation no response	Remote control and UFO is not successful	Please re-perform the remote control and the flying saucer
Connect the flying saucer battery There's nothing wrong with the orbiter should.	<ol style="list-style-type: none"> <li>1. Check if the remote control and the flying saucer are powered on</li> <li>2. Check whether the remote control and the UFO battery are in a low power state</li> <li>3. Is the battery positive and negative</li> </ol>	<ol style="list-style-type: none"> <li>1. Turn on the remote control and insert the UFO battery.</li> <li>2. Use full charge Full battery</li> <li>3. Reinsert the battery and confirm that the battery and battery are positive or negative Pole piece of contact is normal.</li> </ol>
Push the throttle lever. The motor does not turn and flies The indicator light on the disc starts flashing	UFO lithium battery power shortage	Charge the battery or replace another fully charged battery
The flying saucer main rotor continues turn but cannot take off	<ol style="list-style-type: none"> <li>1. The main rotor deformation</li> <li>2. UFO battery power shortage</li> </ol>	<ol style="list-style-type: none"> <li>1. Replace the main rotor</li> <li>2. Charge or replace the battery with another battery</li> </ol>
The flying saucer vibrates badly	Main rotor deformation	1. Replace the main rotor
The flying saucer will still go on or on After moving	The gyroscope is not at all right	The remote control can be automatically corrected mode, or restart the re-frequency
The flying saucer fell behind and lost flat On the fly.	The gyroscope is not at all right	The remote control can be automatically corrected mode, or restart the re-frequency