



PILOTS HAND BOOK

HIGH PERFORMANCE BATTLE DRONES

T-65 X-WING

PILOT'S HANDBOOK

WARNING: Never leave Li-poly batteries charging unattended for extended periods of time. Please refer to enclosed safety instructions.

PACKAGE CONTAINS:

- T-65 X-WING
- 2.4 GHz WIRELESS CONTROLLER
- 2 X-WING BATTERIES
- INSTRUCTION BOOKLET
- CHARGER + USB CABLE + WALL ADAPTER
(wall adapter + USB is for both packaging and battery charger)
- PROTECTIVE TRAINING CAGE
- SCREWDRIVER (in side of controller)
- PROPELLER MULTI-TOOL
- FAUX BATTERY COVER (for use with collectors display box)
- SPARE PARTS
- COLLECTOR'S LIGHT UP DISPLAY BOX

Colors and styles may vary (BC)

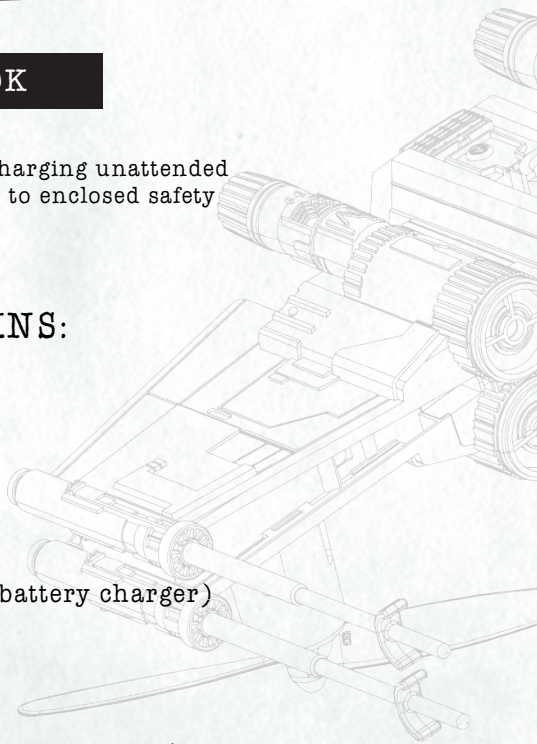

TABLE OF CONTENTS

PAGE

01. Features	04
02. Pilot's gear	Fold-out page (After Pg. 4)
03. Vehicle stats	05
04. Removing the X-wing from the box	06
05. Display case functions	06
06. Controller battery installation	07
07. Ship battery installation	08
08. Charging your ship's battery	09
09. Replacing the propeller blades	10
10. Turning your controller on	10
11. Syncing your ship	11
12. Controller functions	14
13. Learning how to fly (T-mode)	15
14. Protective cage	16
14. Preparing for flight	17
15. Flight Controls	18
16. Flying tips	18
17. Recognizing the front and back of your ship	18
18. Speed select	19
19. Turn On/Off LEDs & auxiliary weapons	20
20. Auto-start and auto-land	21
21. Combat	22
22. Warnings	31
23. FCC Notice	33
24. Warranty and legal information	34
25. Pilot's Log	36

TABLE OF CONTENTS

FEATURES:

- Built-in 6-axis gyroscope keeps the X-wing extremely stable in all conditions
- 4-channel flight controls allow for incredible maneuvering including 360° rolls
- LED directional lights make your ship easy to follow
- Hand-painted collectible ship
- Running lights illuminate your ship during low-light flying
- Barometric pressure sensor (repulsorlift) for fixed altitude hovering
- Auto-start and auto-land functions
- Gyroscope calibration
- Crash protection with Auto-Land
- T-mode training for beginner pilots
- Dynamically integrated sound tracks and battle sounds create an immersive experience
- Controller tactile feedback during battling sequences
- Replaceable batteries for extended play
- Swappable Li-poly batteries for continuous play
- Infrared battling technology
- Built-in *Star Wars* soundtracks for complete sonic immersion
- Controller speaker and headphone jack
- Collectible identifying marks for traceability
- Easy-to-replace parts and transparent blades
- Protective cage
- Wax seal (If you are reading this you have already broken the wax seal)
- Screwdriver for replacing controller batteries and ship repair
- ...and a few fun surprises

COMING SOON:

- Companion smartphone app coming soon. Stay posted at www.propelsw.com



PILOT'S GEAR

Back Lights

Battery Lock

Bluetooth Sync for future app integration

Barometric pressure sensor On/Off

Battery

Auto-start / Auto-land

Neck Strap Attachment
(Lanyard not included)

Propeller

Life LED's

Calibrate Gyro

Handle grip

Turn On/Off LED's

Speaker

Headphone Jack

Controller Power on/off

Battery Cover

IR Transmitter

Speed change

Counterclockwise Roll

Left Gimbal (Control stick)

IR Receiver

Phone holder Pull tab

Weapons Fire

Clockwise Roll

Right Gimbal (Control stick)

Extended
Phone Holder
Detail

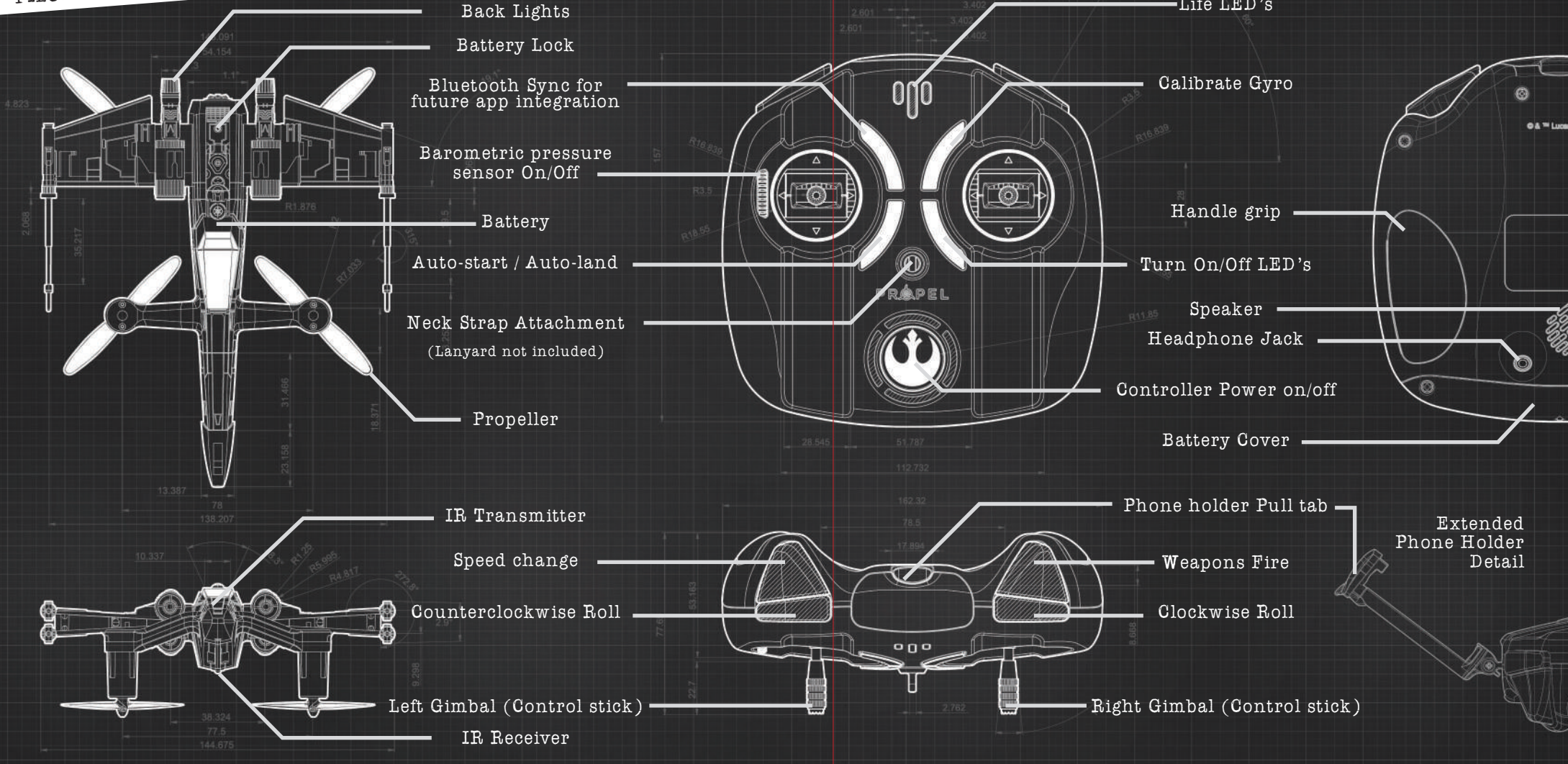

VEHICLE STATS



74-Z Speeder Bike™



Engine:

Aratech military-grade repulsorlift

Land Speed:

500 km/hr

Construction:

Reinforced durasteel

Operators:

1 pilot

Weapons:

One Ax-20 blaster cannon



TIE Advanced X1™

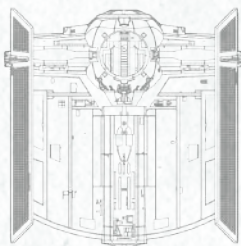

Reactor:

SFS I-s3a solar ionization

Engines:

SFS P-s5.6 twin ion

Atmospheric speed:

1200 km/hr

Spaceframe:

Reinforced durasteel

Crew:

1 pilot

Weapons:

Two L-s9.3 laser cannons



T-65 X-Wing™

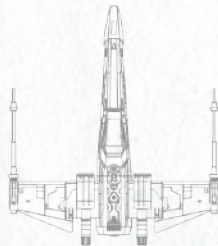

Reactor:

Novaldex O4-Z cryogenic power cell

Engines:

Four Incom 4L4 fusial thrust

Atmospheric speed:

1050 km/hr

Spaceframe:

Titanium alloy

Crew:

1 pilot, 1 astromech droid

Weapons:

Four Taim and Bak KX9 laser cannons

REMOVING THE X-WING FROM THE DISPLAY CASE

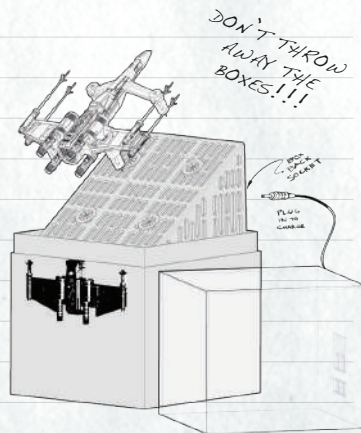
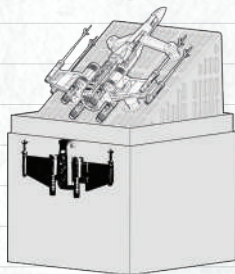

Carefully remove the top cover of the box and the acrylic window from the packaging, and place them somewhere safe. To free the ship from the support, gently pull up on the body of the ship and release the motors from the rubber grommets. Slowly pull the ship away from the surface of it's support, making sure not to force it.

Important note: For packaging and display purposes the propeller blades are not pre-installed on the ship. You will need to follow the instructions for installing propeller blades on page 10.

DISPLAY CASE FUNCTIONS

When the cover is removed, the inside display case will come to life with light and music.

Note: Each time you replace the cover of the box and open it, a new music track will play.

To recharge the display case, first remove the acrylic top. This will give you access to the display charging port in the back side of the display fixture. Use the included USB cable and wall adapter. When the display is charging, the sound and lights will turn off. When the battery is fully charged, the display lights will turn on again. Now you are ready to replace the acrylic top of your display box.

If you are unsure if the battery is charging, remove the charging cable after several minutes of charging and the display should light up. Fully charging the display case takes approximately 40-60 minutes under normal conditions.

Note: Be sure to disconnect the charging cable once the packaging is fully charged to preserve the battery.

When battery is low the lights will flash.

OPEN PAGE
TOP SECRET

REMOTE CONTROL BATTERY INSTALLATION



USE ALKALINE OR 1.5V
RECHARGABLE BATTERIES

1. On the back of the controller, unscrew and slide off the battery cover. *- THERE IS A SCREWDRIVER HIDDEN IN THE RIGHT SIDE ARM OF THE CONTROLLER.*

2. Install 4 "AA" alkaline batteries (1.5V rechargeable batteries are preferred) into the controller. *CHECK PROPER ORIENTATION!*

3. Replace the battery cover and secure it with screws.

4. Replace the screwdriver into the side of the controller

1 - UNSCREW AND SLIDE

2 - 4 AA BATTERIES

3 - PUT BACK COVER

(ALL THE LEDS ON THE CONTROLLER
SHOULD BE FLASHING)

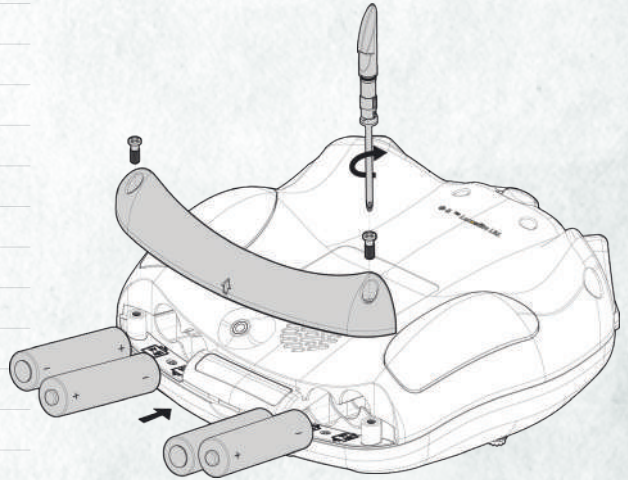

5. Turn over the controller and push the power button for 2 seconds, and verify that the LEDs are on.

SHIP BATTERY INSTALLATION

1. During your first installation, slide the clasp to the unlocked position (as shown in illustration) to unlock the battery. Next, remove the battery cover that comes in the package, as this cover is cosmetic and used for display purposes only.
2. Slide the fully-charged battery into the ship's battery compartment (see diagram).
3. Push down and make sure the battery is fully seated as shown below. The ship's LED lights will illuminate and start flashing when the battery is properly connected.
4. Close the clasp to lock the battery securely in place.

FIRST INSERT THE NOSE
OF THE BATTERY AT A
FORWARD ANGLE, NEXT
PUSH THE BACK OF THE
BATTERY DOWN

SLIDE TO LOCK /
UNLOCK BATTERY

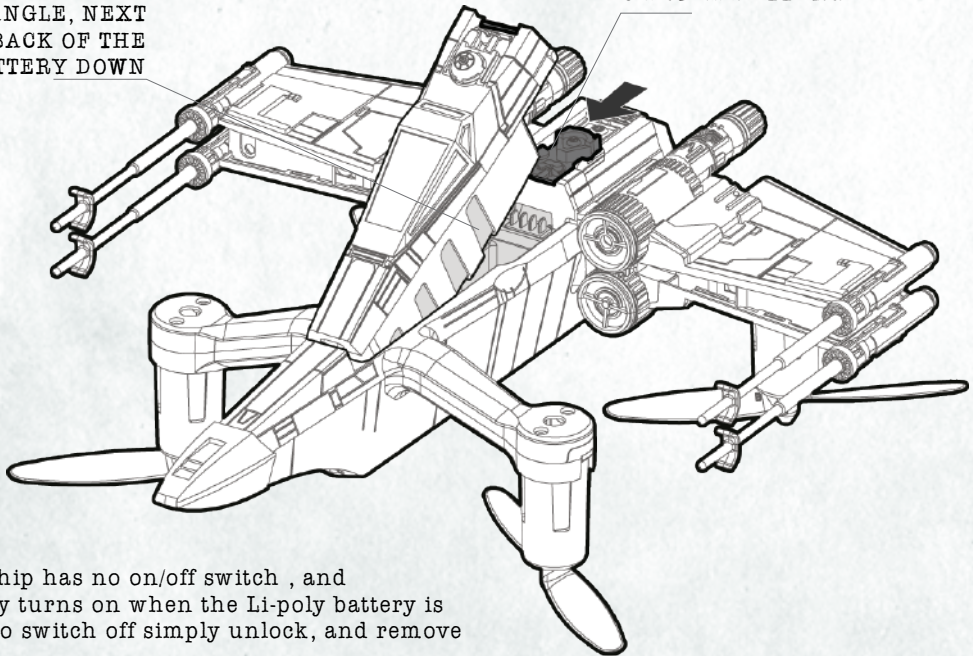

NOTE: The ship has no on/off switch, and automatically turns on when the Li-poly battery is connected. To switch off simply unlock, and remove the battery.

CHARGING YOUR SHIPS LI-POLY BATTERY

1. Insert the correct wall socket extension into the wall adapter depending on the country you are in (see illustration A).
2. Next, connect the USB charging cord to the wall adapter and the charger.

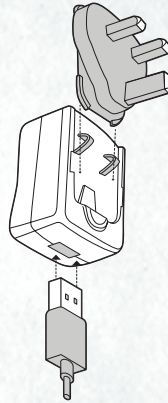
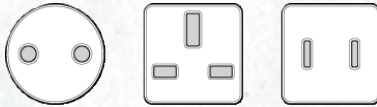

Illustration A

NOTE: THE CHARGING ADAPTER WILL SHOW A RED INDICATOR LIGHT WHEN PLUGGED IN, AND A BLINKING RED INDICATOR LIGHT WHEN CHARGING THE BATTERY.



STEADY RED -> PLUGGED IN

BLINKING RED -> CHARGING IN PROGRESS

3. When the ship's battery is charged to 90%, the charging indicator light will turn blue.
4. When the ship's battery is fully charged, the charging indicator light will turn green.



GREEN
Fully charged



BLUE
90% charged

5. Average charging time is approximately 30 minutes to reach 90% charge and an additional 10 minutes to charge completely. We suggest flying at a 90% charged battery. A 90% charged battery can power your ship for 6-8 minutes depending on environment and flight aggressiveness. Never leave Li-poly batteries sitting in charger for extended periods of time.

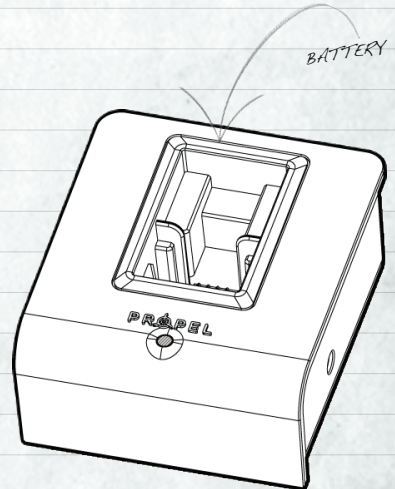

PROPELLER INSTALLATION AND REPLACEMENT

Your X-wing's propeller system is a precision instrument that may need repair or replacement from time to time for optimal flight function. Crash landing from high-speed aerial flights may cause damage to your propellers.

1. The ship has four propellers, two "A" Propellers, and two "B" Propellers.
2. When replacing the propeller blades, make sure to put A propellers on A Motors, and B Propellers on B motors, as per the diagram at the right.
3. To replace the blade, gently pull off the broken blade and snap the new correct blade in place by pushing down firmly.

Multi-Tool:

The multi-tool is used to help install and remove the propellers from the ship.

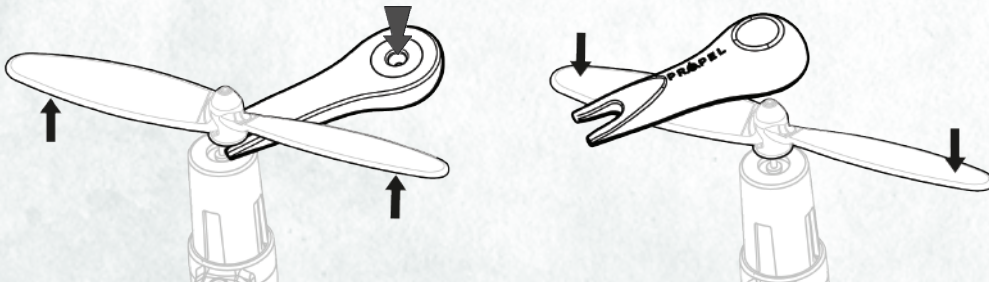
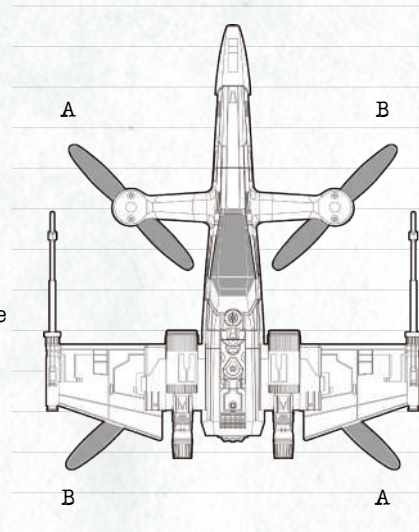

1. To remove the propeller, wedge the thin side of the multi-tool between the motor mount and the propeller and push the propeller upwards.
2. To install the propeller use the opposite side of the multi-tool to push down on the propeller blade. You will notice some pressure and then the blade will move into place. The proper position of the propeller is when the base of the blade shaft is seated slightly below the motor hole. Always check to make sure that the blade spins freely.

PROPEL

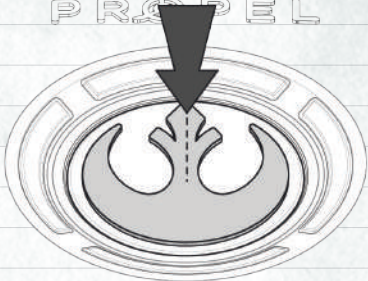

**2 SECOND PUSH
ON/OFF**

*AT THIS POINT YOU MAY
CHOOSE TO LISTEN TO THE
OPENING SOUNDTRACK THAT
PLAYS WHEN YOU POWER ON
YOUR CONTROLLER, WHILST
YOU CONTINUE READING THIS
HANDBOOK.*

*ALL LIGHTS
FLASHING RED*

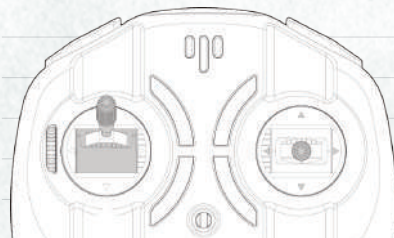

WARNING!

Do not fly your ship in foul weather!



Important! When syncing your ship with the controller, always check that the ship is on a flat level surface. This ensures that the 6-axis gyro is properly calibrated. Your ship utilizes an automatic 2.4 GHz channel selection system that allows up to 12 people to fly side-by-side in the same wireless range with no interference.

CONTROLLER POWER ON/OFF

Hold button for 2 seconds and the power will turn on, followed by a slight vibration. All LEDs (life LEDs and speed LEDs) will flash red until the controller is synced to the ship.

Hold button for 2 seconds and the power will turn off. The vibration motor will spin and all LEDs will flash red for 3 seconds.

SYNC TO SHIP: FOR SINGLE-PERSON PLAY

Push the left control stick all the way up until you hear 1 beep, then push the stick all the way down. You will hear 2 beeps to indicate the controller is synced. Once synced, the LEDs surrounding the power button will illuminate to indicate the selected speed.

At this point you may want to listen to the opening soundtrack that plays after your controller powers on, while you continue reading.

MUSIC MODE

Music mode lets you adjust the volume on your speaker or headphones or choose a background track. To enter music mode, hold down button 2 and button 4 for two seconds. The Life LEDs will glow blue (or red in simulation mode). Push both buttons again for two seconds to exit music mode. If no buttons are pushed for five seconds while in music mode, the controller will automatically exit the mode.

No other buttons will function while in music mode except for the 4 buttons on the face of the controller (buttons 1, 2, 3, and 4).

1. Change track: Push once to change the track (up to six times). Push again to shuffle all tracks (confirmed by the “shuffle all” sound). Push again to turn off the music but keep the sound effects (confirmed by the “music off” sound). Push again to turn all sounds off (confirmed by the “all sound off” sound). Push again to start over again from the beginning.

2. Change Volume: To change volume first enter music mode, then push button (3) to increase volume or push button (4) to decrease volume.

(See diagram)

X-wing soundtracks

TITLE: “MAIN TITLE”
MOVIE: *STAR WARS: A NEW HOPE*

TITLE: “THE BATTLE OF ENDOR 1”
MOVIE: *STAR WARS: RETURN OF THE JEDI*

TITLE: “THE THRONE ROOM”
MOVIE: *STAR WARS: A NEW HOPE*

TITLE: “THE ASTEROID FIELD”
MOVIE: *STAR WARS: THE EMPIRE STRIKES BACK*

TITLE: “ALLIANCE ASSEMBLY”
MOVIE: *STAR WARS: RETURN OF THE JEDI*

TITLE: “LANDOS PALACE”
MOVIE: *STAR WARS: THE EMPIRE STRIKES BACK*

TITLE: “THE STARS AWAIT”
COMPOSER: DAVID PELLICCIARO

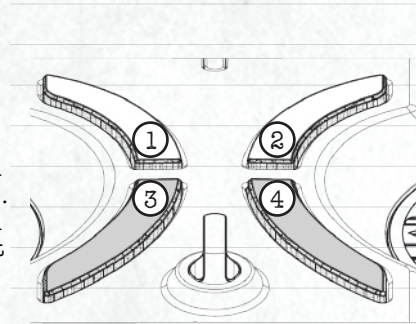

ENTER MUSIC MODE

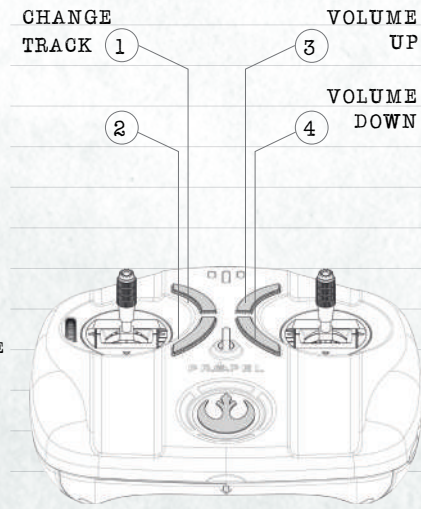
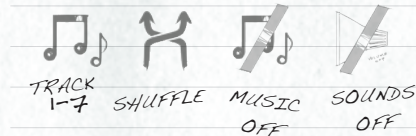

SCREWDRIVER

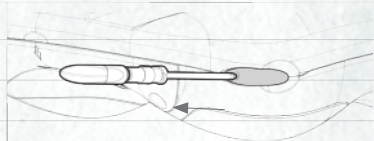

This handy screwdriver attaches to your controller and can be used to remove screws from the battery cover or to tighten the screw on the phone holder. It can also be used to remove parts on your ship if repairs are needed.

SPEAKER

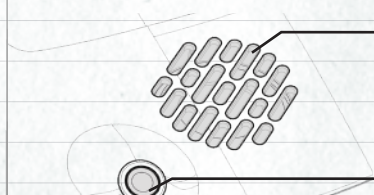

The controller's speaker will play every sound, including music, explosions, and more.

HEADPHONE JACK



The controller's headphone jack functions in the same way as the speaker, but will only work when the headphones are plugged in. When headphones are connected, the controller's speaker will switch off and all sound will be routed through the headphones. When the headphones are unplugged, sound will resume through the speaker.

NECK STRAP ATTACHMENT

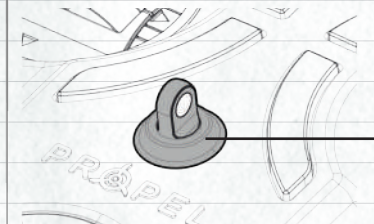

For use with a lanyard, to help support the controller around your neck. (Lanyard not included)

CALIBRATE

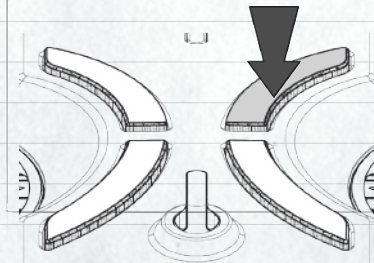

If you experience a hard landing or crash, and your ship begins to drift in a particular direction, you will need to land and recalibrate the gyro. On a flat level surface with the ship's motors stopped, hold down the button for 2 seconds to calibrate the gyro.

BAROMETRIC PRESSURE SENSOR ON/OFF (REPULSORLIFT ON/OFF)

The barometric pressure sensor maintains the altitude of your ship above the ground, simulating the anti-gravity effect of a repulsorlift engine. This also lets you adjust your altitude incrementally during flight. Push the gimbal up or down and then release it, and your ship will hover at the new altitude.

Having the barometric pressure sensor activated enables your ship to perform an auto-start, but it also limits your angle of inclination and makes it less agile at performing stunts.

SMARTPHONE HOLDER

To use the smartphone holder, extend the pull tab on the top back side of the controller and pull it out until you hear a click.

Pull the end out and place your smartphone inside. It will close around your smartphone using spring pressure.

You can adjust the angle of your phone and lock it into place by tightening the screw at the base of the phone holder using the screwdriver in the side of the controller.

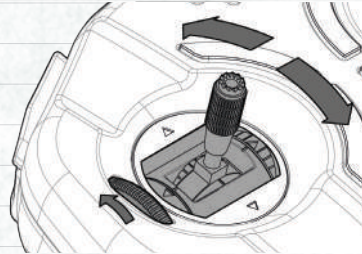

Barometric Pressure OFF

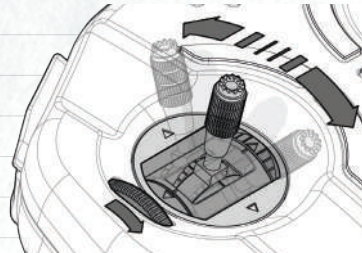

Barometric Pressure ON

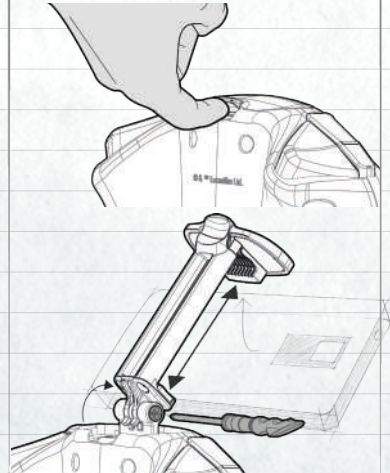

LEARNING HOW TO FLY (T-MODE)

If this is your first time flying please read the following instructions. If you are an experienced pilot feel free to skip ahead to the next section.

T-mode is a special flying mode intended to help ease new pilots into learning basic flight controls in a safe environment. To operate in T-mode you must first activate the repulsorlifts on the controller (see repulsorlifts on page 14). When in T-mode, your ship will help you to learn how to fly by moving in a controlled slow rate with added stability. T-mode allows you to familiarize yourself with the various functions of the control sticks before moving on to normal speed ratings.

INVISIBLE CEILING AND FLOOR:

When flying upwards in T-mode, your altitude is automatically governed by an invisible ceiling at approximately 6 feet (2 meters). In addition to the ceiling there is also an invisible floor that prevents your ship from touching the ground creating a safe area to fly. In order to land your ship in T-mode you will need to activate the auto-landing sequence (See auto-landing on page 21).

To enter T-mode, hold down the speed change button for 3 seconds. You will know you have entered T-mode when all the lights around the power button turn blue. To exit T-mode simply press the speed control button once again and you will hear a beep and the LED speed indicator lights around the power button will return to red.

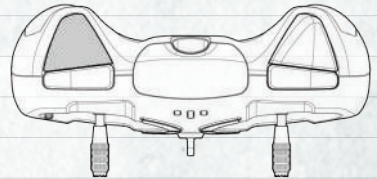
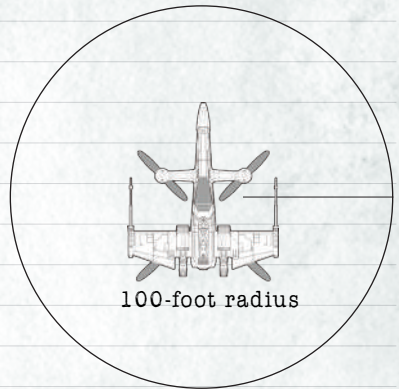

T-MODE

PROTECTIVE CAGE

For beginner pilots we strongly suggest using the protective cage. Make sure you install your protective cage before flight. This cage protects the propeller blades and the outside of the ship from taking damage when crashing into walls and other objects.

INSTALLING THE CAGE:

To install the cage place the ship in the cage with the central bar running from front to the back (not side to side) and with the 4 C-shaped plastic connectors slide over each of the motor arms (see diagram a). Proceed to securely fasten the cage by pinching the 4 C-shaped connectors with your thumb and forefinger until you feel a small snap indicating that the connector is locked into the motor arm (see diagram b).

Note: Make sure the cage C-shaped connectors are seated all the way in the highest position (see diagram c)

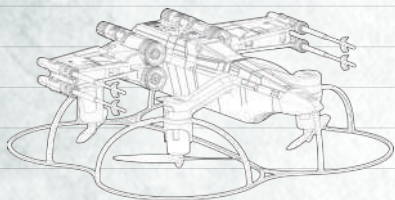

diagram c

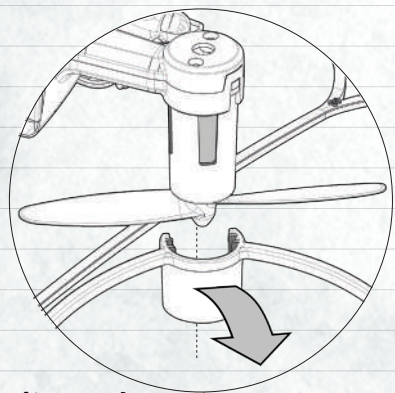

diagram b

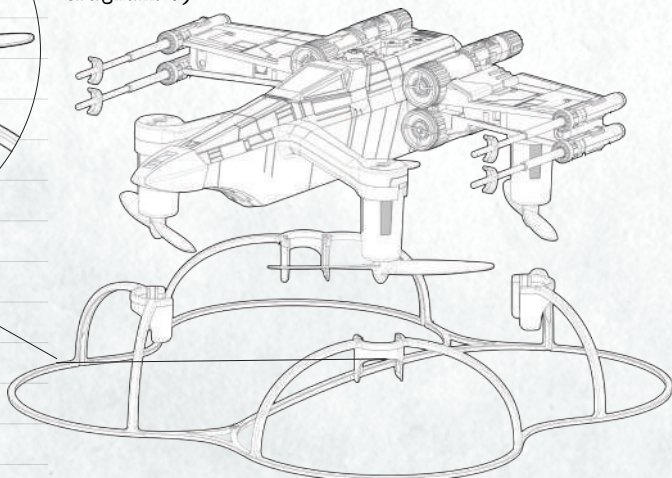

diagram a

FOR MULTI-PERSON PLAY

Before beginning, ensure that all ships and controllers are powered off. Make sure that no other 2.4 GHz devices are in the area.

Each person must sync their ship individually, one at a time, in order to avoid interference. Follow steps on page 11 (“SYNC TO SHIP: FOR SINGLE-PERSON PLAY”), making sure to keep away from others while ensuring that no one else is syncing at the same time.

After one player syncs their ship, it should be left on until all players have finished syncing their own ships.

Should a mistake or interference occur, all players should turn off their controllers and ships for 60 seconds and begin the process again.

PREPARING FOR FLIGHT

- Verify that the controller has 4 “AA” batteries and the ship’s battery is fully charged.
- Make sure your ship and controller are both powered on.
- Operate in a large space, with an open radius of at least 100 feet.
- Check the environment to ensure it has no obstacles or a river. Set your ship on a clean flat surface before takeoff.

DO NOT FLY YOUR Ship DURING RAIN, SNOW, OR HEAVY WINDS.



SPEED 1



SPEED 2



SPEED 3



T-MODE

RED BULL'S -STOP
FLASHING WHEN SYNCED
TO SHIP

- ✓ 4 “AA” BATTERIES
- ✓ POWER ON
- ✓ 100 FOOT RADIUS
- ✓ NO RIVERS
- ✓ GOOD WEATHER

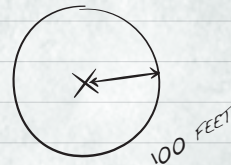

FLIGHT CONTROL

These are the basic flight functions for your ship. While learning to fly it is best to begin with a large space, at least until you get used to the basics. Once you master your ship you can tackle more advanced maneuvers.

Practice makes perfect! Once you have these steps mastered, move to the next level.

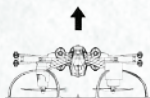

Move the Throttle up to increase the speed of the motors and the X-wing will rise up.

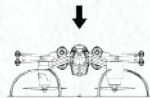

Move the Throttle down to decrease the speed of the motors and the X-wing will descend.

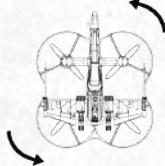

Move the Throttle stick left and the X-wing will rotate left.

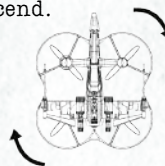

Move the Throttle stick right and the X-wing will rotate right.

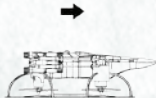

Move the Direction Control up and the X-wing will move forward.

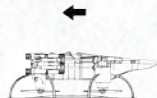

Move the Direction Control down and the X-wing will move backward.

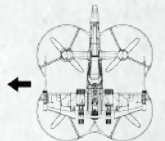

Move the Direction Control left and the X-wing will bank to the left.



Move the Direction Control right and the X-wing will bank to the right.

FLYING TIPS

- Operate your ship in a wide space. Ideally, the space will have at least a 100-foot radius.
- If you are flying your ship with others, make sure spectators are located behind you.
- For best performance, it is recommended that you operate the ship during zero wind conditions, as wind can greatly affect flight performance.

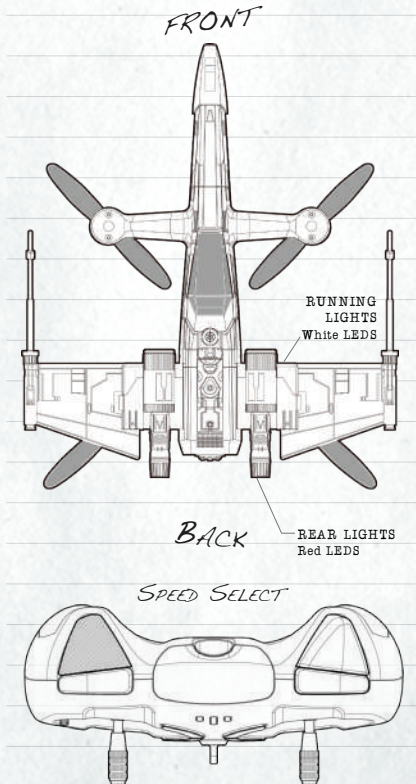

RECOGNIZING THE FRONT AND BACK OF THE SHIP

Even though your ship has four rotors, it still has a “front” or forward-facing direction, and a “back” or backwards-facing direction.

NOTE: The front of the ship displays white LEDs. The back displays red LEDs.

SPEED SELECT BUTTON

Your ship has 3 speed settings: SLOW, MEDIUM and HIGH. The default setting is SLOW.

Change the speeds using the speed select button.

Select your speed according to your flying skill. The speed select button is located on the top left side of the controller.



SPEED 1



SPEED 2



SPEED 3



T-MODE

SPEED CHANGE

When the controller is powered on, it will always start on Speed Mode 1. If the controller was in Speed Mode 3 before turning it off, it will return to Speed Mode 1 when it is turned back on.

Push the button to change speeds between Modes 1-3. If you are in Speed Mode 3 and press the button, you will cycle over to Speed Mode 1.

Flying speed is indicated by the LEDs surrounding the controller's power button.

RED - SYNCED TO SHIP

TURN ON/OFF LED'S AND AUX WEAPONS

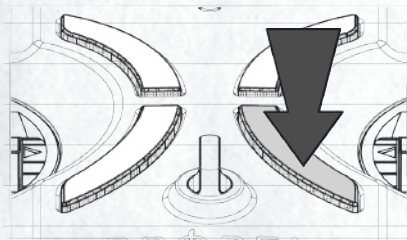

Push the button for 1 second (you will hear 1 beep) to turn on/off the white LEDs that illuminate your ship. (The red LEDs in the rear of your ship will remain on.)

Hold down the button for 4 seconds (you will hear 2 beeps) to turn on/off your ship's aux weapons.

Note that when the set of aux weapons are activated, the IR transceiver will be deactivated, and vice versa.

1 BEEP

1 seconds

on/off

white LEDs

2 BEEP

4 seconds

on/off

aux weapons

EMERGENCY STOP

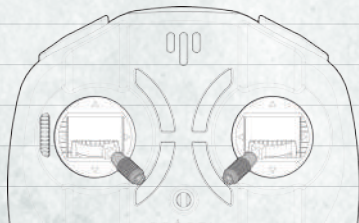

Simultaneously push the left and right gimbals (control sticks) down and in to activate the emergency stop. This will cut all power to the motors and the ship will fall to the ground. This is only to be used in case of emergency, as the ship may get damaged when it hits the ground.

AUTO-START/AUTO-LAND

When repulsorlifts are activated, push button once when on the ground to auto-start.

Push button for 2 seconds when in the air to auto-land.

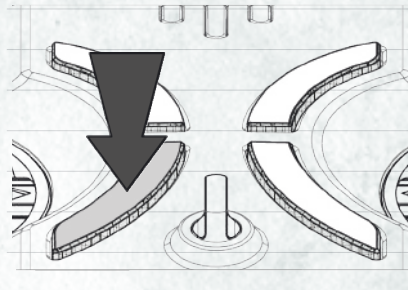

AUTO-START

Auto-start only works when the barometric pressure sensor is activated.

If barometric pressure sensor is activated, auto-start will work only if the left stick (gimbal) is in the center position.

The right control stick will function normally during the auto-start sequence, allowing you to control the direction of your take-off.

After auto-start button is pressed, motors will activate and the ship will take off and hover at a height of approximately 6 feet.

If the left stick (gimbal) is pushed up or down, the auto-start will be canceled and normal controls will resume.

AUTO-LAND

Push button for 2 seconds while in the air to auto-land.

When auto-land is pushed it will override the left sticks (gimbals) control, unless the left stick (gimbal) is moved up or down during the auto-land operation.

The right control stick will function normally during the auto-land sequence, allowing you to control the direction of your descent.

If the barometric pressure sensor is off (for a manual take-off), then the left stick must be moved all the way down before the blades will unlock and allow you to control the throttle manually.

CLOCKWISE ROLL (A)

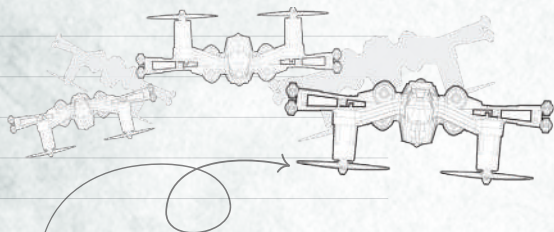

Push the right trigger button while flying and your ship will perform a 360-degree roll in a clockwise motion while continuing its current movement. If the ship is flying forward it will continue to move forward as it performs the roll, and will perform similarly with any directional movement.

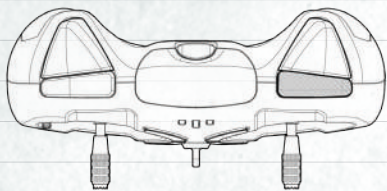

Clockwise Roll (A)

COUNTERCLOCKWISE ROLL (B)

Push the left trigger button while flying and your ship will perform a 360-degree roll in a counter-clockwise motion while continuing its current trajectory.

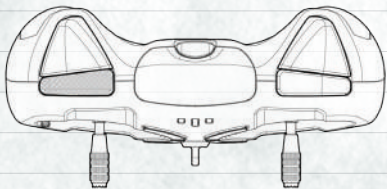

Counterclockwise Roll (B)

WEAPONS FIRE (C)

Your ship comes pre-installed with infrared battling transmitters and receivers as well as laser receivers. Only one type of weapon can be used at a time, meaning you can either fight with infrared weapons or with aux weapons.

Push the button to fire the weapon. Let go and push again to fire a second time.

The weapons button activates either the infrared LED or the aux weapons, depending on which weapons system is equipped. If aux weapons are activated, the infrared LED transmitter and receiver will be deactivated. If the infrared LED transmitter is activated, the laser receivers will be deactivated.

When weapons are fired, you will hear a sound from the controller's speaker (or headphones if plugged in).

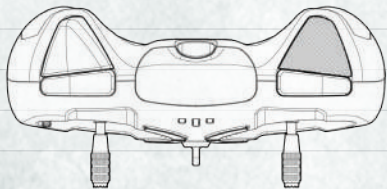

Weapons Fire (C)

BATTLING

When battling with your vehicle it is best to fly outside in a wide open space of about 200-300 feet, in an open field with no obstruction such as trees, houses, open water, or power lines. When battling indoors it is recommended to do so in a very large open area such as a gymnasium or sports center with high ceilings and no obstructions.

IR BATTLING

With IR battling, the infrared transmitters in the front of the ship will send a signal and the infrared receiver beneath the ship will register a hit.

IR battling is relatively easy because it sends a wide signal and the receiver points down underneath the ship. If you aim anywhere beneath your target ship from a range of less than 2-3 meters, you will most likely score a hit.

A few things to note about IR battling:

Sunlight greatly reduces the distance that an IR signal can travel. Battling outside in daytime means that you will need to be especially close to your opponent to score a hit.

When battling indoors, IR signals can bounce off of walls (especially white walls). You can sometimes achieve a hit even if you weren't directly aiming at your opponent, if you fire using the right angle.

When IR battling, you will not be able to battle with any *Star Wars* ships that are set to use aux weapons.

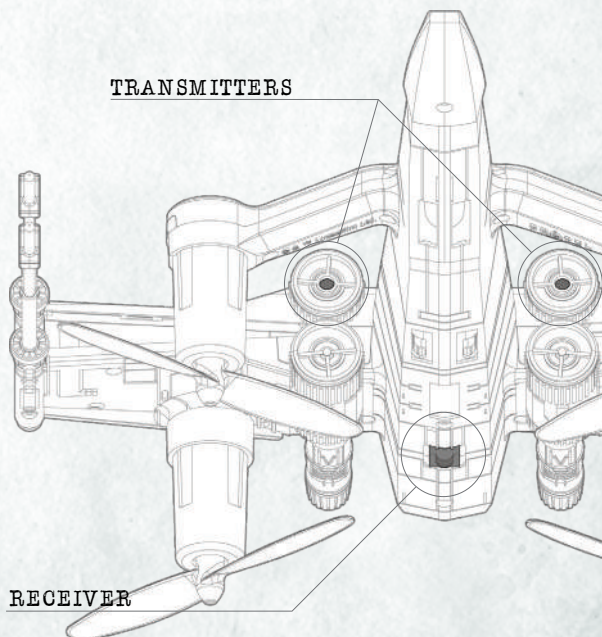

LIFE LED'S

When the controller's power is turned on, all 3 life LEDs will flash.

Once synced, all 3 life LEDs will glow red.

Reactions to being hit:

When the ship is hit by an opponent, it will react and alter its flight.

No additional hits can be inflicted on the ship during this time.

FIRST HIT:

The ship will continue on its current trajectory, but will rock back and forth two times left to right in a fluid motion. The controller will vibrate for 3 seconds and play a unique sound effect through the speaker. During this time, the 3 life LEDs will flash and the ship will not react to any other weapons. At the end of the maneuvers, only 2 life LEDs will remain lit, and the player who has struck your ship will receive a notification through their controller of a successful hit.

SECOND HIT:

Similar to first hit, but the movement will be more aggressive. The 3 life LEDs will flash and the ship will not react to any other weapons. At the end of the rocking, only 1 life LED will remain lit, and the player who has struck your ship will receive a notification through their controller of a successful hit.

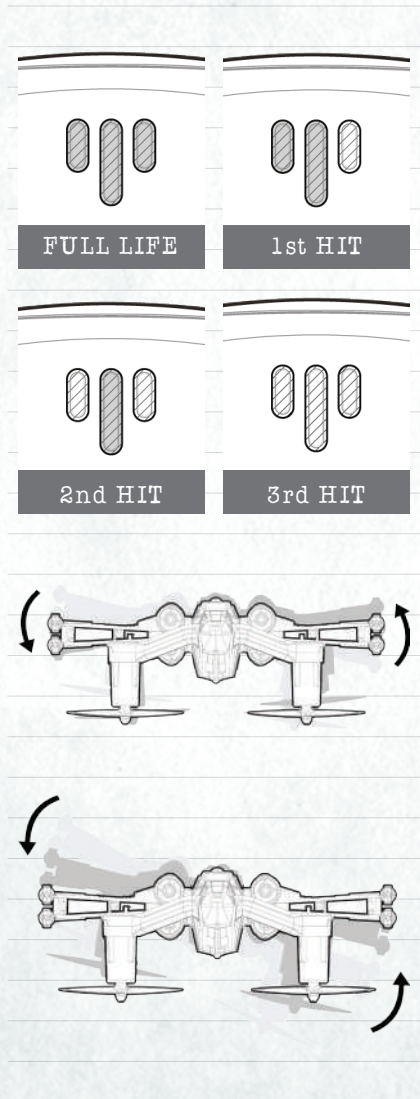

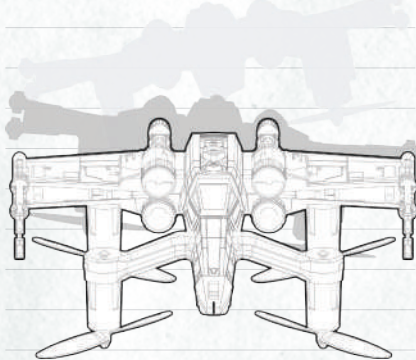
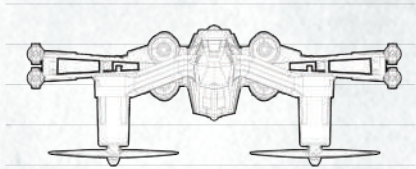

THIRD HIT AUTO-LANDING

This is the final hit in battle.

When you have been hit a 3rd time your ship will enter into auto-land mode and descend in a downward spiral.

TAKING OVER LANDING SEQUENCE

Pulling your left throttle stick all the way down during auto-landing sequence will activate user-controlled landing mode.

This feature allows you to take control of your direction while you fall.

This may be used to avoid hitting an obstacle.

IN ADVANCED MODE (REUPULSORLIFT DEACTIVATED)

When descending, all the controls will remain active except the throttle, allowing you to move freely and create your own crash-landing pattern.

GAME RESET

During a 3rd hit auto-landing you will have no access to throttle as your ship descends and stops. During this time, the 3 life LEDs will flash and the ship will not react to any other weapons fire.

All flight controls will return to normal after the 10 seconds are up. Three new life LEDs will light up on your controller, signifying that you may re-enter the battle.



NOTES

CIRCULAR STRAFE

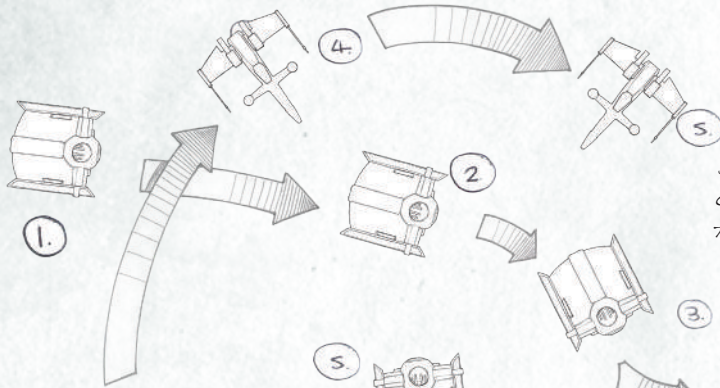

STAY IN FRONT
OF YOUR ENEMY'S
TURN

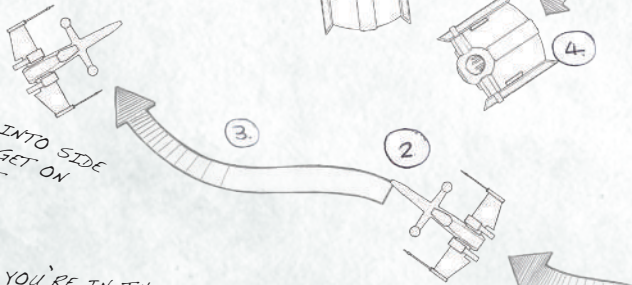

WATCH FOR THE
COUNTER TURN!

EASE INTO SIDE
SLIP-GET ON
TARGET

WHEN YOU'RE IN THE RIGHT SPOT, USE A COMBINATION OF YOUR YAW AND AILERON (SIDEWAYS STRAFE) CONTROLS TO STRAFE IN A FULL CIRCLE AROUND YOUR OPPONENT. IF YOU TIME IT RIGHT, YOU CAN DEVASTATE IMPERIAL ATTACKERS.



NOTES

DROP BACK AND ATTACK

①

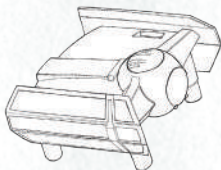

①

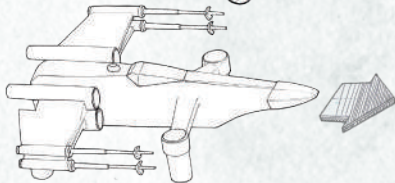

KRIFF THE
EMPEROR!

②

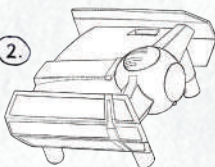

②

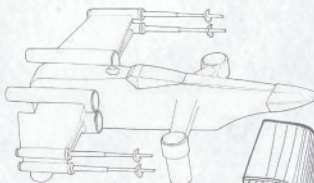

CLEAR SKIES

WATCH HIM SAIL BY!

③

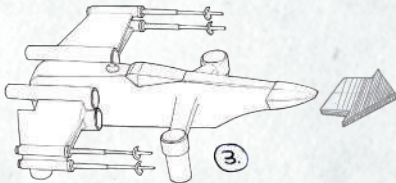

③

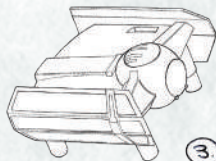

CUT YOUR THROTTLE AND DROP BENEATH THE ELEVATION OF A CHASING ENEMY. PROTECT YOUR X-WING'S VULNERABLE UNDERBELLY WHILE MANEUVERING INTO ATTACK POSITION!



NOTES

REVERSE THROTTLE HOP

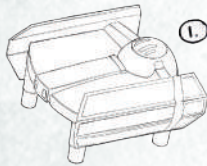

1

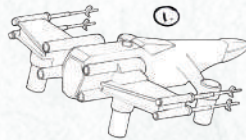

1



SAY NO TO MEMORY-WIPED
ASTROMECHS

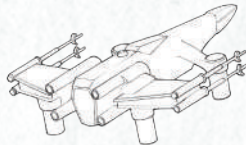

2

NOSE UP! PROTECT YOUR
BELLY

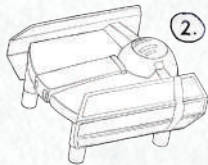
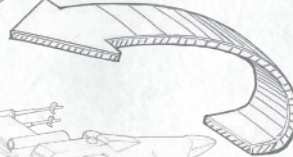

2

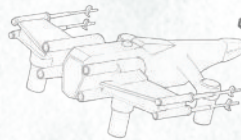

GET ON HIS TAIL QUICK!

3

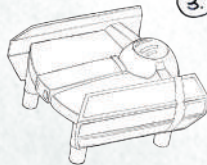
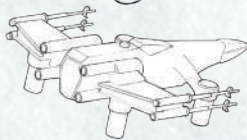

3

WHEN YOUR ENEMY IS CLOSING IN FROM YOUR REAR, EXECUTE A JUMPING HOP, BY PULLING UP AND EASING OFF ON YOUR THROTTLE, LOSING YOUR FORWARD SPEED AND DROPPING BACK BEHIND THEM. IF YOU DO IT RIGHT, YOU'LL FIND YOURSELF IN A POSITION FOR A KILL SHOT.



NOTES

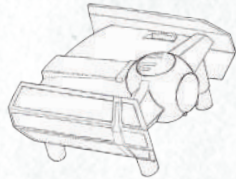
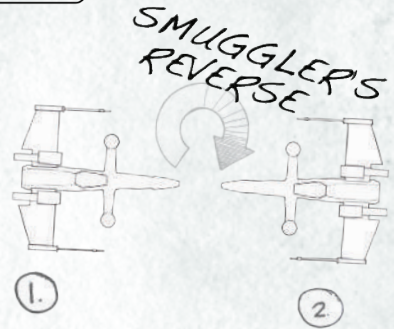
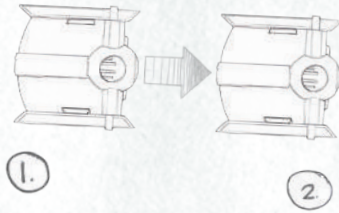

DROP BELOW TO ATTACK
YOUR ENEMY'S BELLY

PREY TURNS PREDATOR

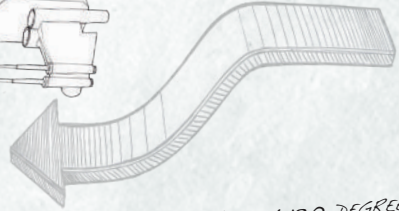
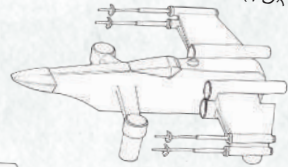
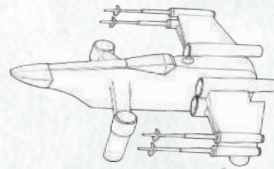

180 DEGREE
YAW TURN

MOST REBEL PILOTS KNOW THIS ONE. MAKE A 180 DEGREE TURN AT FULL THROTTLE, RESULTING IN A RAPID DIRECTIONAL CHANGE WITH ALMOST NO TURNING ARC. YOU CAN THEN SURPRISE YOUR ENEMY WITH A FOUR-CANNON LASER BLAST. THIS BOLD MANEUVER CAN SURPRISE AN ENEMY WITH ITS BRAZEN, STARING-DEFEAT-IN-THE-FACE APPROACH!



NOTES

TALLON ROLL

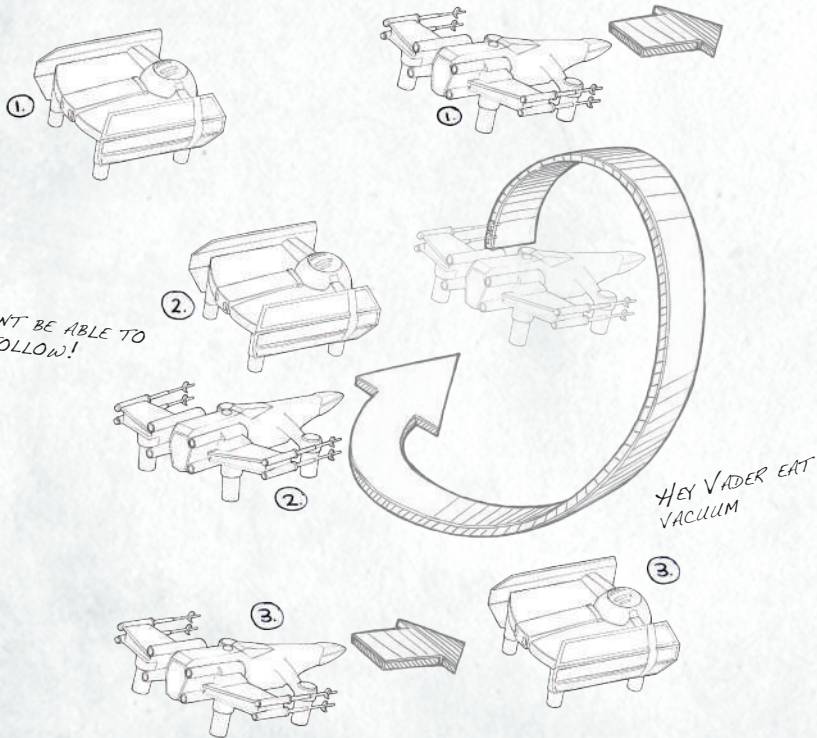

NAMED AFTER ADAR TALLON, IMPERIAL DEFECTOR WHO BRAVELY AIDED THE ALLIANCE, THE TALLON ROLL IS A TRICKY TECHNIQUE THAT'S EXECUTED WHEN AN ENEMY PILOT IS APPROACHING FAST FROM THE REAR.

IF THE PILOT LEVELS OUT AND PULLS UP WHILE ROLLING AWAY FROM THE DIRECTION OF THE TURN, THEY CAN SLIP BACK IN BEHIND THE ENEMY WITH NO LOSS OF DISTANCE OR SPEED.

X-WING WARNING

Your X-wing is designed for INDOOR or OUTDOOR use. The X-wing blades revolve at high speeds and can cause harm to the user, spectators, and animals.

Stand clear of the ship to reduce the risk of getting into its flight path. Warn spectators that you will be flying your ship so that they can remain aware of its position. Before flying, inspect the ship's rotor blades to ensure they are securely fastened.

WARNING!

Choking/Cutting Hazard: Small parts/sharp rotor blades.

Keep hands, hair and loose clothing away from the propeller when the power switch is in the ON position.

Turn off the controller and ship's power switches when not in use.

The included charger is built specifically for the X-wing's Li-poly battery. Do not use it to charge any other battery.

New alkaline or rechargeable 1.5v batteries are recommended for maximum performance.

BATTERY WARNINGS

This ship uses a Li-poly rechargeable battery. If the battery no longer stays charged, dispose of it properly according to local disposal requirements.

CONTROLLER BATTERIES:

Controller requires 4 "AA" batteries (not included). Please read the important battery safety warning below.

Do not mix alkaline, standard (carbon-zinc) and rechargeable batteries (Nickel Metal Hydride).

Do not mix old and new batteries.

Non-rechargeable batteries are not to be recharged.

Rechargeable batteries are to be removed from the item before being charged (if removable).

Rechargeable batteries are only to be charged under adult supervision.

Exhausted batteries should be removed immediately and must be recycled or disposed of properly according to state or local government ordinances and regulations.

The supply terminals are not to be short-circuited.

Only batteries of the same or equivalent type as recommended are to be used.

Batteries are to be inserted with the correct polarity (see inside booklet for diagram).

Do not dispose of batteries in a fire as batteries may leak or explode.

CARE AND MAINTENANCE

Always remove the batteries from the controller when it is not being used for an extended period of time.

To clean, gently wipe the controller and ship with a clean damp cloth.

Keep your equipment away from direct heat or sunlight.

Do not submerge the controller or ship in water. This can damage the unit beyond repair.

Parental guidance recommended when installing or replacing batteries.

FCC PART 15 C NOTICE

CAUTION: Changes or modifications not expressly approved by the party responsible for compliance could void the user's authority to operate the equipment.

NOTE: This equipment has been tested and found to comply with the limits for a Class B digital device, pursuant to Part 15 of the FCC Rules. These limits are designed to provide reasonable protection against harmful interference in a residential installation. This equipment generates, uses and can radiate radio frequency energy and, if not installed and used in accordance with the instructions, may cause harmful interference to radio communications. However, there is no guarantee that interference will not occur in a particular installation. If this equipment does cause harmful interference to radio or television reception, which can be determined by turning the equipment off and on, the user is encouraged to try to correct the interference by one or more of the following measures:

- Re-orient or relocate the receiving antenna.
- Increase the separation between the equipment and receiver.
- Connect the equipment into an outlet on a circuit different from that to which the receiver is connected.
- Consult the dealer or experienced radio/TV technician for help.

This device complies with Part 15 of the FCC Rules. Operation is subject to the following two conditions :

- (1) This device may not cause harmful interference, and
- (2) this device must accept any interference received, including interference that may cause undesired operation.

PROPEL UK RETURNS POLICY

At Propel, we make premium products using the very best components.

There are, on occasions, reasons for customers to return products to us. Propel UK offers a 90-day warranty to cover these eventualities, the details of which can be found on the Propel UK website at propelrc.co.uk.

In the event of this being necessary you are required to choose the correct reason for the return. The details as to what is required are below. For our full terms and conditions please visit our website and select "customer care," where you will find our Returns Policy and Procedures.

If you have simply changed your mind:

If you have received an item which you have decided you do not wish to keep for whatever reason, then you must inform us within 7 working days of the proof of purchase, in writing to the following address:

Propel UK C/O 9, Sterling Centre Eastern Road Bracknell Berkshire United Kingdom
RG12 2PW

Alternatively, you may send an email to customercare@propel.co.uk.

ITEMS FAULTY ON ARRIVAL

If you receive your item and find it to be faulty, you have 7 working days from the proof-of-purchase date to inform us, either in writing by mail to the address above or by e-mail to customercare@propel.co.uk.

A Propel Customer Care Representative will contact you and provide you with an RMA form containing all the necessary information for us to proceed with your request. We will then arrange to collect the item from you, and once the fault has been verified, we will either replace or fully refund the item. If however, the item is found not to be faulty, you will be charged for all return carriage costs incurred by us. Again, all items should be returned in their original packaging complete with any accessories, power cords and/or documentation, including manuals.

RETURNED ITEMS FAILING

WITHIN THE WARRANTY PERIOD

If a fault occurs within the first 90 days from the date of purchase (and the fault is covered under the manufacturer's guarantee) then you will need to go to propelrc.co.uk and select the "customer care" link and request a Return Merchandise Authorization Form or "RMA". You will need to ship the product to our address (see above) with a copy of the completed RMA form inside the box. Once the item is received, our technicians will inspect the product and if found faulty, repair or replace the product and ship it back to you at no extra cost.

All returned goods must be returned in adequate packaging. Propel will not be responsible for any damage that is incurred to goods that are not packaged in the original packaging that the goods were shipped in. If you do not have the original packaging, you will need to obtain appropriate packaging and ensure that the returning goods are protected against the rigors of courier transit. Please also send the package in a manner that requires a signature upon delivery. Propel UK will not be responsible for any packages mislaid or stolen in transit.

If the returned item is found not to be faulty and the problem is one of incorrect usage, operator error and/or operator damage, the customer will be liable for the carriage costs of the goods back to us and also for returning the product back to the customer. Once product is received, our warranty repair technicians will review the product to determine if it was actually faulty or not. If the product is deemed not faulty according to Propel's warranty guidelines, a customer care representative will contact you with a quote to repair and replace the product. Please note that all carrier charges and repair charges must be collected before we can return the product.

Please ensure that all goods returned have a copy of the original proof of purchase and a completed RMA form stating the full reasons for return. Failure to do this may slow down any repair or refund.

ITEMS DAMAGED DURING TRANSIT

In the event that you purchased online, and later signed for, an item that has clearly been damaged in transport, you should add a comment to your signature for the items with the courier. You must also still inform us within the 7-working-day period if you have accepted goods which were clearly damaged when you received them by completing the Returns Authorisation Form with all the required information. Items must then be boxed in all original packaging, whether that packaging is damaged or not and again complete with any and all accessories, including paperwork and manuals. We will then arrange collection of the item. Once we receive the item back into our shop we will send a replacement item out to you or if requested, we will issue a full refund to the credit card used to pay for the item.

In all cases, any goods being returned must be adequately packaged and protected. Propel UK will not be responsible for any damage or loss of goods that occurs in transit back to us.

If you need to reach us, please email us at customerservice@propelrc.co.uk. Alternatively, you can go to www.propelrc.co.uk and click on the "customer care" tab to schedule an appointment to speak with a propel customer care associate.

Refunds

Qualifying refunds shall be made within 30 days from receipt of returned goods, and shall be for the full original purchase price you paid for said goods, provided that the goods are returned by you at your own cost and received by us in a new and unused condition. Qualifying goods returned otherwise shall be refunded the full original purchase price less any costs incurred in shipping or re-packaging.

Please ensure that all goods returned have a copy of the original proof of purchase and a completed RMA form stating the full reasons for return. Failure to do this may slow down any repair or refund.

Schipholweg 321, Badhoevedorp 1171 PL, The Netherlands
+44 (0) 330 123 3457

© 2016 Rooftop Group Europe, BV. All Rights Reserved.
www.propelsw.com

PILOT'S LOG



www.propelsw.com