

**Ruko**<sup>®</sup>

**14+**  
for age

# User Manual

v2.0

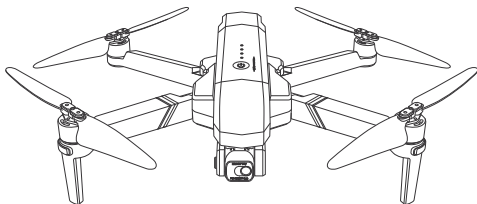

# F11GIM2

CONTACT US FOR MORE TECH SUPPORT

 +1 (888)892-0155 | Mon-Fri 7:00AM - 7:00PM (PST)



rukotoy.com

CONTACT US FOR MORE TECH SUPPORT

 +1 (888)892-0155 | Mon-Fri 7:00AM - 7:00PM (PST)

 +86 19129317359



# Contents

<b>1 Using This Manual</b>	4
1.1 Legend	4
1.2 Read Before the First Flight	4
1.3 Video Tutorials	4
1.4 Download the App	4
<b>2 Package Contents</b>	5
<b>3 Preface</b>	6
<b>4 Warning</b>	10
<b>5 Fly Safety</b>	13
<b>6 Remote Controller</b>	15
6.1 Controller Features	15
6.2 Controlling the Drone	16
6.3 Optimal Transmission Zone	21
6.4 Emergency Stop	21
6.5 Charging the Controller	22
<b>7 Drone</b>	22
7.1 Preparing the Aircraft	22
7.2 Drone Diagram	23
7.3 Assemble the Propeller	23
7.4 Intelligent Flight Battery	24
7.5 Gimbal and Camera	24

<b>8 Drone Status Indicators</b>	27
<b>9 Product Functions Profile</b>	28
9.1 Return to Home	28
9.2 Waypoint Flight	30
9.3 Point of Interest	31
9.4 GPS Follow Me	32
9.5 Image Recognition Follow Me	32
9.6 Hand Gesture	33
<b>10 Connect the APP</b>	33
10.1 Download the APP	33
10.2 Connect the APP with Drone	33
<b>11 APP Functions</b>	34
11.1 Control	34
11.2 APP Icons Introduction	35
<b>12 APP Setting</b>	36
12.1 Setting	36
<b>13 APP Functions</b>	38
13.1 APP One Key Share Function	38
13.2 How to Download the Pictures and Videos	40
<b>14 Flight</b>	42
14.1 Take Off/Landing Procedures	42
14.2 Quick Start	42

<b>15 Specifications</b>	44
15.1 Drone	44
15.2 Gimbal Stabilization	44
15.3 Camera	45
15.4 5G Transmission	45
15.5 APP/Live View	45
15.6 Remote Controller	46
15.7 Intelligent Flight Battery	46
15.8 Charging Cable: Type-c	49
<b>16 Common Problems</b>	47
<b>17 Accessories Support</b>	52

# 1 Using This Manual

## 1.1 Legend

- The following terms are used throughout the product literature to indicate various levels of potential harm when operating this product :

✔ Recommend    ✘ Warning    ⚠ Hints & Tips    📖 Reference

## 1.2 Read Before the First Flight

- Read the following documents before using Ruko drone.
  - ① User Manual
  - ② Quick Start Guide
  - ③ Disclaimer and Safety Guidelines
- It is recommended to watch all the guide videos on our website and read the disclaimer and safety guidelines before using for the first time.

## 1.3 Video Tutorials

- Scan the QR code to watch the guide videos, which demonstrate how to use Ruko drone.



## 1.4 Download the App

- Scan the QR code download **"RUKO DRONE"** app.



QR code of "RUKO DRONE" for Apple IOS system.

The IOS version of RUKO DRONE is compatible with IOS v9.0 and later.



QR code of "RUKO DRONE" for Android system.

The operation system version of RUKO DRONE is compatible with Android v5.0 and later.

## 2 Package Contents



Drone



Remote Controller



Drone Battery



Gimbal Cover



Spare Propeller



USB Charging Cable



User Manual



Allen Wrench



Screw

## 3 Preface

Thank you for purchasing the Ruko-Series GPS aircraft. Please read all instructions and warnings carefully before operating. Please also keep this instruction manual for future reference and maintenance.

### Important

- This product should be operated by the people who are over 14 years old. It is a precision device; integrating machinery and electronics with air mechanics and high frequency transmission. It requires correct assembly and debugging to avoid any accident. The user should operate and control this product in a safe manner. In case of incorrect operation, it may cause serious injury or damage property. It can also be lost due to incorrect operation.
- This product is suitable for experienced UAV pilots no less than 14 years of age.
- In the event of a problem during using, operating, or maintenance, please contact the local sales agent or retailer or keep in touch with the responsible staff of our company.

### Safety Precautions

This R/C aircraft can be dangerous when in use, **please make sure you keep it far away from any persons or spectators when flying.** In-correct installation, poor conditions, or users not familiar with operation may cause damage to the aircraft or injure people or may cause an unexpected accident. Please pay close attention to flying safety and learn to recognize more dangerous conditions which may cause an accident due to your own negligence.



- **Keep it far away from any structures or crowds.**

This R/C aircraft may vary slightly in speed or sensitivity while flying and can cause potential danger. Therefore, please keep it far away from crowds, buildings, trees, structures, high-voltage wire, etc. Please also avoid flying in adverse weather conditions such as rain, electrical storms, and high winds to ensure safety of the user, any spectators, and surrounding property.

- **Keep it away from any moist environment.**

The inside of the aircraft is composed of many precision electronic and mechanical parts. Therefore, please try to avoid any moisture or water content from entering the main body of the aircraft as it may cause a breakdown of the mechanical and electronic parts and thus cause an accident.

- **Only operate with included parts for intended use.**

Please use the original parts made by Ruko-Series for any re-equipping or maintenance to ensure flying safety. Please operate and use only under the scope of the product function permitted. Using un-approved parts will void warranty.

**DO NOT** use for any illegal purpose or use beyond the scope of which your local laws and regulations have stipulated.

- **Avoid controlling it independently.**

New users may have certain difficulties during the early stages of learning to operate this aircraft. Please try to avoid operating the aircraft alone. When available, always operate this aircraft under the guidance of a more experienced user.

- **Do not operate under the influence of drugs or alcohol.**

Please operate this R/C aircraft according to your own state and flying skill. Any fatigue, bad mental state, or incorrect operation may increase the probability of accidental risk.

- **Do not operate under the influence of drugs or alcohol.**

Please operate this R/C aircraft according to your own state and flying skill. Any fatigue, bad mental state, or incorrect operation may increase the probability of accidental risk.

- **Please keep a safe range from aircraft when using top speed.**

When the operator is flying in high speed, please keep the aircraft far from the pilot and any surrounding persons or objects so as not to cause danger or damage.

- **Store it in a cool, dry place.**

The R/C aircraft is composed of material such as metal, fiber, plastic, electronics, etc. Therefore, please keep it away from any heat source and avoid prolonged exposure to direct sunlight. Excessive heat exposure can cause distortion and damage.

 This equipment has been tested and found to comply with the limits for a Class B digital device, pursuant to part 15 of the FCC Rules. These limits are designed to provide reasonable protection against harmful interference in a residential installation. This equipment generates, uses and can radiate radio frequency energy and, if not installed and used in accordance with the instructions, may cause harmful interference to radio communications.

However, there is no guarantee that interference will not occur in a particular installation.

If this equipment does cause harmful interference to radio or television reception, which can be determined by turning the equipment off and on, the user is encouraged to try to correct the interference by one or more of the following measures:

Reorient or relocate the receiving antenna.

Increase the separation between the equipment and receiver.

Connect the equipment into an outlet on a circuit different from that to which the receiver is connected.

Consult the dealer or an experienced radio/TV technician for help.

Please note that changes or modifications not expressly approved by the party responsible for compliance could void the user's authority to operate the equipment.

## 4 Warning

There is important information contained in this package and instruction manual, please keep it for future reference.

- You have the responsibility to make sure that this model of aircraft won't cause injury to others' body or cause any damage to property.

Please operate strictly as shown on the instruction manual when debugging or assembling this aircraft. During the process of flying or landing, please pay more attention to keep 1-2 meters between the user and the aircraft to avoid colliding to the head or face or

- body, which may cause injury.

Our company and distributors won't be responsible for any incorrect operation, which may cause loss or damage or injury to the

- body.

Children ages 14 and up should use this product under the guidance of an adult. This product is FORBIDDEN to be used by children

- under 14 years old.

Please correctly assemble and use this product as shown on the instruction manual or packing instruction. Some parts should be

- assembled by an adult.

Small parts are included with this product. Please place it beyond the reach of the children to avoid a CHOKING HAZARD or parts

- being mistakenly swallowed.

Playing on the road or near high traffic areas is strictly FORBIDDEN

- so as not to cause an accident.

Please dispose of the packing material timely so as not to cause

- injury to children.

**Please DO NOT** disassemble or re-equip the aircraft as it may cause a breakdown of the aircraft during flying.

- Batteries in the battery compartment of the charger should be inserted into the designated power source which has the same logo as the product.
- Built-in rechargeable 3.7V lithium polymer battery included in the transmitter.
- Only the original charging cable make from our factory can be used.
- **Charging cable is not a toy.**
- When charging the battery, please conduct it under the surveillance of an adult. Please also keep it far away from any combustible object when charging. Please keep this aircraft within eyesight when charging.
- **Please DO NOT** make it short-circuited or squeeze the battery so as not to cause an explosion.
- **DO NOT** mix the Li-ion battery with a different type of battery.
- Intelligent lithium battery is loaded in the Quad-rotor. Both built-in or external can be used for charging.
- **Please DO NOT** make the battery short-circuited or decompose the battery or throw the battery into the fire; **DO NOT** place the batteries near the high temperature or heated area (such as near the fire or near the electric heating device).
- The aircraft should be kept far away from any other electric compliance or equipment as far as possible or kept far away from the place where having the magnetic object nearby as they may cause interference with each other.
- Please keep the safe distance from the high-speed rotating rotor so as not to cause twisted or danger of being wounded or being cut.
- Engine will heat up. **Please DO NOT** touch it to avoid being burned or injured.

- **Please DO NOT** close this product to your ear as it may cause injury to your hearing.
- Type-C 5V wall charger recommended for charging. **DO NOT** use any charger stronger than 5V.
- To comply with the command of the magnetic environment requirement formulated by the Aviation Radio Bureau and the related authority, during the regulated period in certain areas, please stop using the transmitter of this model when such regulation command is issued.
- Keep your UAS within sight.
- Never fly over groups of people.
- Never fly over stadiums or sports events.
- Understand airspace restrictions and requirements.



**⚠️ • Product should only be used by adults and children 14 years and older. Adult supervision required for children under 14 years of age.**

## 5 Fly Safety

### • WIFI transmission area requirements:

- ① Make sure correctly open the remote control antenna.
- ② Make sure fly in the open area without any interference and obstacle.
- ③ Do not fly against the wind; WIFI transmission distance is 3KM.



Fly in Open Areas

+



Strong GPS Signal

+



Maintain Line of Sight

+



Maximum flight altitude height is about 120 meters



- Avoid flying over or near obstacles, crowds, high voltage power lines, trees, airport or bodies of water.

**DO NOT** fly near strong electromagnetic sources such as power lines and base stations as it may affect the onboard compass.



- **DO NOT** use the drone in adverse weather conditions such as rain, snow, fog and wind speeds exceeding 7 m/s or 16 mph.
- 

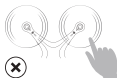

Stay away from the rotating propellers and motors.



It's important to understand basic flight guidelines, for the safety of both you and those around you. Don't forget to read the Safety Guidelines before flight.

---



## 6 Remote Controller

### 6.1 Controller Features

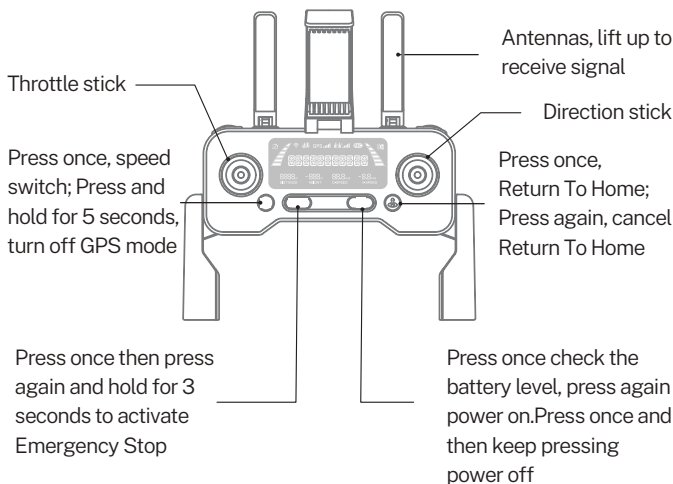
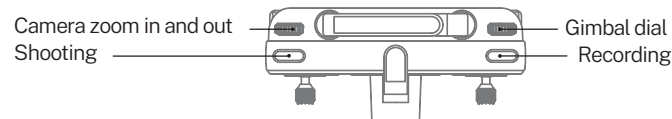

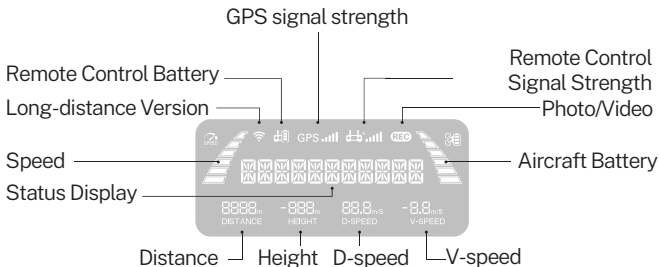

- The F11 GIM2 has **three** speed mode: **Camera mode** 14.76 ft/s, **Normal mode** 29.53 ft/s, and **Sport mode** 39.37 ft/s. The default speed is Normal mode, higher speed will consume battery faster.

## 6.2 Controlling the Drone

- Remote Controller Stick Mode-Mode 1 (Default Mode)

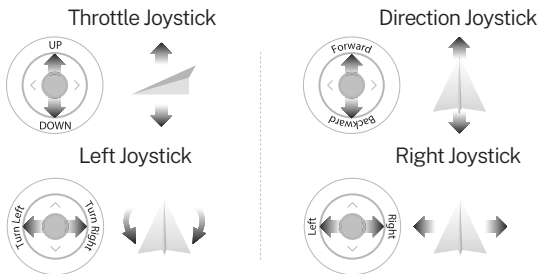

## • Switch Remote Controller Stick Mode--Mode 2

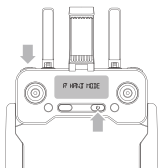

Power off the remote control.

Keep pressing the , clicking the  twice.

(Click once indicating the power level, click again the remote control beeps three times and power on, LED screen indicates "RHAND MODE".)

**Note:** Once restart, the controller will back to default mode - Mode 1.

Direction Joystick



Left Joystick





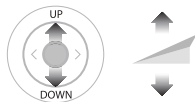

Throttle Joystick

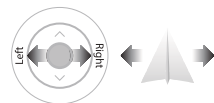

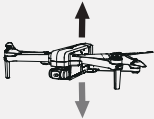
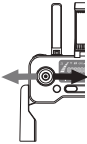

Right Joystick



Transmitter (Default Mode)	Aircraft Direction
	
<p style="text-align: center;"><b>Remarks</b></p> <p>Push up/down the throttle stick to control the aircraft up and down.</p> <p>Push up and the aircraft rises. Pull down the lever and the aircraft lowers. When released, the joystick is in the middle position and the aircraft remains hovering.</p> <p>When the aircraft takes, the throttle lever must be pushed up and the aircraft takes off the ground (please push the stick slowly to prevent the aircraft from suddenly rush up).</p>	
Transmitter (Default Mode)	Aircraft Direction
	
<p style="text-align: center;"><b>Remarks</b></p> <p>Push the throttle stick left/right to control the aircraft heading.</p> <p>Push the stick to the left and the aircraft will rotate counter-clockwise. Push the stick to the right and the aircraft rotates clockwise. In the neutral position, the angular velocity of rotation is zero, and the aircraft does not rotate.</p>	

Transmitter (Default Mode)	Aircraft Direction
	
Remarks	
<p>Push up/down the direction bar to control the aircraft to fly back and forth.</p> <p>Push the stick up and the aircraft leans forward and flies forward. Pull down the lever, the aircraft tilts backwards and flies backwards. The aircraft's front and rear directions remain level in the neutral position. The joystick offset corresponds to the angle of the aircraft's front and rear tilt. The greater the offset, the greater the tilt angle and the faster the flight speed.</p>	

Transmitter (Default Mode)	Aircraft Direction
	
Remarks	
<p>Push the direction stick left/right to control the aircraft to fly left and right.</p> <p>Hit the stick to the left, the aircraft tilts to the left and flies to the left. Hit the stick to the right, the aircraft tilts to the right and flies to the right. The left and right directions of the aircraft remain horizontal in the middle position.</p> <p>The joystick offset corresponds to the angle of the aircraft left and right tilt. The greater the offset, the greater the tilt angle and the faster the flight speed.</p>	

## 6.3 Optimal Transmission Zone

- The signal between the drone and the remote controller is most reliable when the antennas are positioned in relation to the aircraft as shown below.

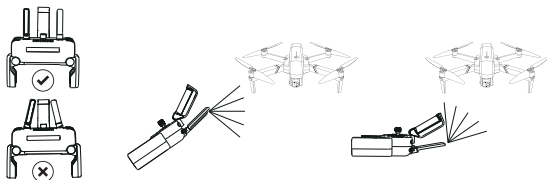

- ⚠️ • DO NOT use other wireless devices to avoid interference to the remote controller.**

## 6.4 Emergency Stop

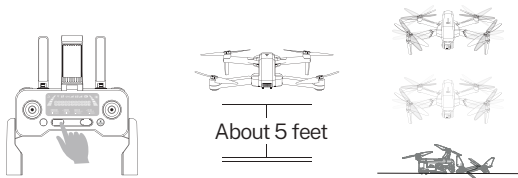

- Click once and hold the **STOP** for **3 seconds** to enter into Emergency Stop mode. It only activated when the drone's flight altitude within 5-42ft.

- ⚠️ • By using this function the drone motor will stop working immediately thus fall to the ground, which might cause damage. Only use this feature when in emergency so as to reduce the risk of damage or injury.**

## 6.5 Charging the Controller

Phone Adapter: 5V--3A

(Not Included)



USB Adapter  
(5V/3.0A)



The Remote Control Is Charging

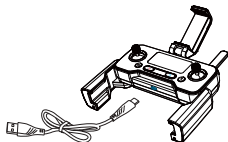

Charging Time: About 2 Hours

(Depending on Charging Adapter)



Fully Charged With Remote Control

- When the remote control is charging, the LED screen will indicate the battery level, when fully charged, it will indicate "BAT 100 PCT". Controller is built-in 3.7V 1500mAh lithium polymer battery. Use the original type-C cable to connect an AC power adapter (5V/3A) to charge. It takes approximately **2hours** to full charge the remote controller. The charging time depends on what adapter are using, suggest to use charger with output current 5V/3A. **Never overcharge.**

## 7 Drone

### 7.1 Preparing the Aircraft

All aircraft arms are folded before ship out of the factory. Please follow the steps below to unfold the arms.

- Take off the Gimbal Cover
- Unfold the front arms

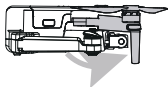



- Unfold the rear arms and then unfold all the propellers

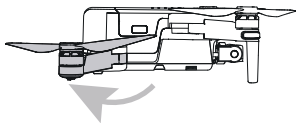

## 7.2 Drone Diagram

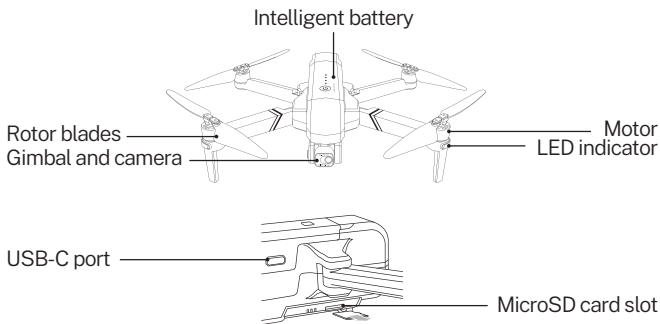

## 7.3 Assemble the Propeller

- Please note that the letter "A" or "B" is printed on each propeller, and make sure all the propellers are attached in the correct motor position.

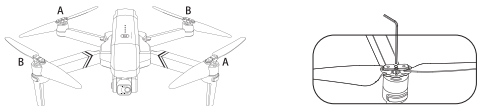

## 7.4 Intelligent Flight Battery

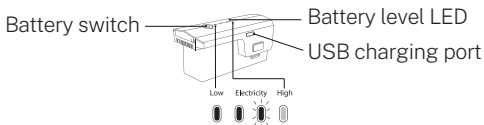

- Hold the switch button for 3 sec.power on; then press the button for 3 sec. power off.
- Refer to the battery level LED, when only one LED left, charge the battery.

- ⚠️ • DO NOT install the battery with the power already switched on.**
- DO NOT charge the battery immediately after flight as the temperature may be too high.Wait until it cools down to room temperature before charging again.**

## 7.5 Gimbal and Camera

- The gimbal of F11GIM2 drone ensure the user can capture clear and stable impage and videos even when the drone is flying, the camera also equipped with electronic stabilization function.
- The camera uses an upgraded 5GHz Wi-Fi FPV real-time transmission function, equipped with 2-Axis Gimbal 4K EIS, 100° FOV lens and a 80° adjustable camera, which can stably shoot 4K ultra-clear videos and images, providing you with a broad field of vision for unforgettable moments.



• Camera Guideline:

- ① Please take off the gimbal camera cover before flight.
- ② When taking off from grass or sand, please place the aircraft on the landing pad or cardboard to keep it level.



⊗ On the grass



⊗ On the sand

- ③ **Do not** turn on the aircraft when it is on desk or hollow wooden floor. They will amplify the small vibrations into high-frequency vibrations, which will cause the gimbal cannot work.

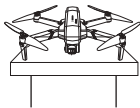

⊗ On the desk



⊗ On the hollow wooden floor

- ④ **Do not** interfere with the gimbal by putting external forces or picking up the aircraft during calibration. Otherwise, the gimbal will stop to work.



⊗ Touching the camera

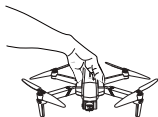

⊗ Picking up the Aircraft  
(during self-inspection)

⑤ The Gimbal cannot work during the compass and Gyro calibration. Put the aircraft on a level surface after calibration, then the gimbal will start to work after **20 seconds**.

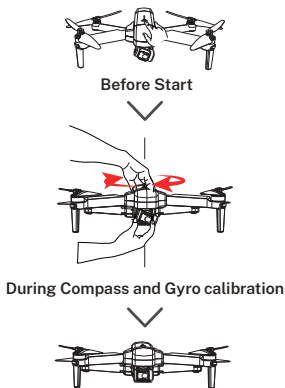





Put on a level surface and wait for 20 seconds

- ⚠ Precision elements in the gimbal may be damaged in a collision or impact, which may cause the gimbal to function abnormally.
- Avoid getting dust or sand on the gimbal and the camera, especially in the gimbal motors.
- DO NOT** apply extra force to the gimbal after the gimbal is powered on, as this may cause the gimbal to function abnormally or even lead to permanent motor damage.
- Make sure to install the gimbal cover when the drone is not in use.
- If the gimbal gets wet after flying in wet weather, temporary failure might occur, make the gimbal and the drone dry so as to get it recover to full function.

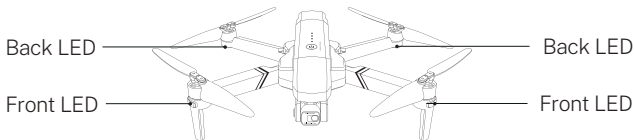
## 8 Drone Status Indicators

- F11GIM2 drone has front and back four LED lights.





LED light indicator	Color	Reason	Action required
Front and back lights flashing red		Low Power	Charge the battery
		The controller is not connected to the drone	Restart and wait for the drone and controller auto-connection
Front and back lights flashing white and pink		The drone turns to Compass Calibration process	Follow the instruction to rotate the drone to complete calibration process
Front and back lights rapid-flashing white and blue		The drone is in Gyroscope Calibration process	Wait till the drone complete calibration automatically (This only take 2-3 seconds)
Front and back lights flashing white and blue		GPS searching	Waiting for GPS signal
			Change to another place and try again

## 9 Product Functions Profile



### 9.1 Return to Home

The Return to Home (RTH) function brings the drone back to the Home Point.

This function can only be achieved under GPS mode. There are three types of RTH: Smart RTH, Low Battery RTH, and Fail connection RTH. If the drone have successfully recorded the Take off Point and the GPS signal is strong, the RTH will be triggered when either the Smart RTH is initiated, the drone battery level is low, or when the signal between the drone and remote controller is lost.

Home Point	GPS	Description
		The default Home Point is the first location where the drone received a strong or moderately strong GPS signal (3 or more satellite reception).

#### • Smart RTH

Smart RTH can bring the drone back to the Home Point. It is initiated by either clicking the  button once on the remote controller or on the app, the remote controller will alert with a "DI DI" sound. Click the  button again cancel the RTH process.

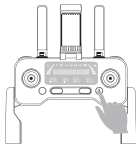

#### • Fail Connection RTH

If the Home Point has been recorded successfully and the compass function can work normally, the Fail Connection RTH function will be triggered once the remote controller signal is lost, the drone will return to the Home point in straight line. The drone may link to the remote controller automatically during the RTH process, if connected successfully, the RTH process will stop.

### • Low-Battery RTH





Low-Battery RTH is triggered when the drone battery level is low, this function is triggered automatically, drone will first rise to the setted return altitude and fly back to the Home Point, this process is unable to cancel, but it is allowed to control the drone with direction joystick to land it in a safe area.

If the battery can't support the drone fly back to the Home Point, it will land automatically where it is, and the remote controller dirction joystick is available during landing.

#### • Cautions

- Never turn off the remote controller during RTH process.
- Set a proper return home altitude on the app before take-off.
- NO obstacle avoidance function is available with this drone.
- When flight distance less than 98 ft, the drone flies back at the current altitude instead of setted return altitude, make sure it flies higher than any other objects surrounding.
- When flight distance further than 98 ft, make sure the drone has enough battery to fly back.
- The drone can NOT return to Home Point without a strong GPS signal.

## 9.2 Waypoint Flight

- When the phone mobile data is available, select  in the app, load the map data of the area which intended to fly.
- Connect the drone's WiFi on the phone, view the map by clicking  on the app.
- The red circle is the limited flight range for this function, click to set points within the red circle to execute the waypoint flight function (16 points the most).
- Click  and  to reset the points of flight route.
- Click , confirm to start Waypoint Flight.
- Push the Direction Joystick to cancel the Waypoint Flight .

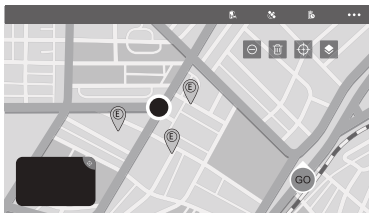





## 9.3 Point of Interest

- This feature enable the drone to fly around the point in a 360 circle.



- Open the app,click "CONTROLS" 
- Click ,click "Point of Interest"
- Slide to right to set the surround radius
- Slide to confirm to perform Point of Interest
- Click "Cancel" to exit Point of Interest







When the electromagnetic interference value is bigger than 150, please land the drone and complete the compass calibration again or change to another place to fly.

 This function will only be available when the GPS signal is strong.

## 9.4 GPS Follow Me



GPS Follow Me function requires strong GPS signal, once the function been initiated, the drone can follow the smart phone wherever it goes, below are the steps to activate this function:

- Connect the drone's WiFi on the smart phone, access to the app CONTROL  interface.
- Make sure the flight distance is within **10-100meters**.
- Click the  on the app.
- Waiting for app to indicate drone status "**Follow Me Ready**", now the drone will move along with the positioning coordinates on the app.
- Click the  on the app interface again to exit the Follow Me mode.

 • **GPS Follow Me function will be affected by the tall structures, trees and the living areas with WIFI signal interference. GPS Follow-me function is not activated when the GPS signal weak or GPS positioning off on the mobile device.**

## 9.5 Image Recognition Follow Me

Image Recognition Follow Me function enables the drone to follow the object's in circle movement to rotate.

- Connect the drone's WiFi on the smart phone, access to the app CONTROL  interface.
- Click , tap on the object or person plans to track, tap to confirm the selection, drone rotates following the object's in circle movement.

 • **Make sure the size of the frame isn't too large, so as to ensure the recognition is achievable.**

## 9.6 Hand Gesture

- Click  on the app, count down 3 seconds to 0 with hand motion to take photos and record video. Follow the instruction on the app.

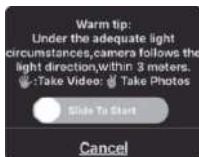

-  **When raise the hand, make sure to keep the elbow at the same height of the shoulder.**

## 10 Connect the APP

### 10.1 Download the App



QR code of "RUKO DRONE" for Apple IOS system.



QR code of "RUKO DRONE" for Android system.

### 10.2 Connect the APP with Drone

- Once the drone and remote controller connected, access "SETTING" on smart phone, open the "WLAN", find the drone's WiFi which name "RUKO-GIM-XXXX", open the app.

#### **Tips:**

- Android phones requires user to check a "confirm connection" after choose the drone's WiFi on the phone, please wait around 10-30 seconds until this reminder come up, otherwise the connection will be failed.



- Once the drone WiFi has been connected, the app will recognize the drone model and connect automatically.

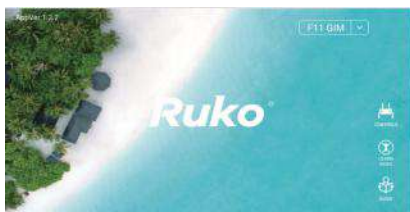

- **CONTROLS:** tap to access the instant video transmission and drone control interface.

**LEARN TO FLY:** tap to watch the guide video.

**GUIDE:** tap in to read the manual, and watch instructional videos.

## 11 APP Functions

### 11.1 Control

- Wait until the drone status says "**Ready to Fly**" before initiating flight, access to the control interface.



## 11.2 APP Icons Introduction

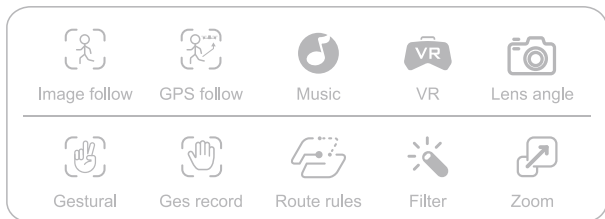
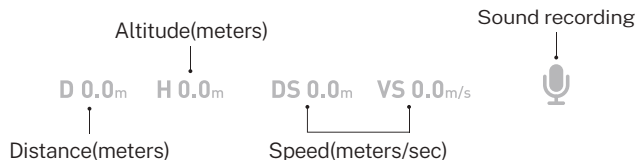
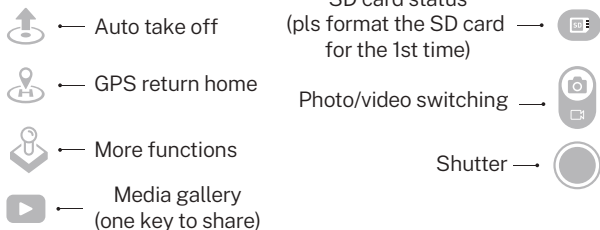
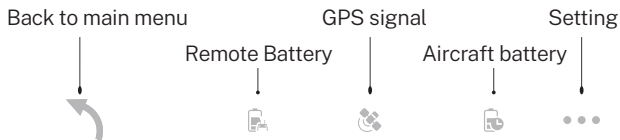

- User can refer to the aircraft flight direction from the Attitude Indicator in the app.

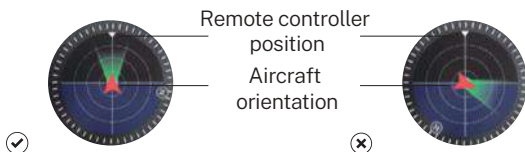

## 12 APP Setting

### 12.1 Settings



#### • Flight Setting and Out of Beginner Mode

While the drone is under GPS mode, its default mode is Beginner Mode, Which limits the flight range: Maximum Flight Distance is 30 meters; Maximum Flight Altitude is 30 meters; Setted RTH Altitude is 20 meters; Follow below picture to turn off the Beginner Mode and set the proper flight setting in the app.

 **The drone must be conneted with the app to save the setting.**



### • Find the Lost Drone

When the drone has connected with app, and drone GPS signal is strong, the drone's location can be recorded in the app.

- ① Access to "Track", click **Find aircraft >** to open the map surface to search the drone.

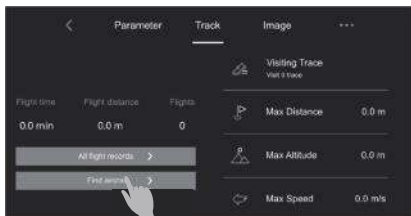

- ② The last position of lost drone will be showed on the map.



Current position of the mobile phone

- **Gimbal Back to Factory Setting**

Get the gimbal back to factory setting, access to "PTZ adjust", click "Restore factory setting"



- **How to change units**

This function enables to switch the units between Inch(MPH), Meter(m/s), Metric(km/h).



## 13 APP Functions



### 13.1 App One Key Share Function

- Open the app, click  , enter into the file (Pic 1.)



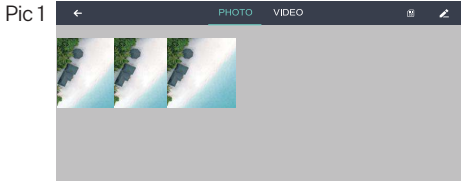



- Click once or press  to select the photos which to share, click , choose the media to be shared (Pic 3)

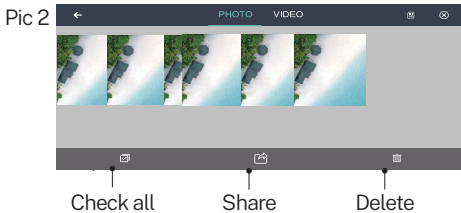



- ⚠ • It is only allow to share 9 pictures or 1 video the maximum at one time.

## 13.2 How to Download the Pictures and Videos

After shooting and recording were completed, photo and video save to both the app album and microSD card, to download the files:

- Connect the drone's WiFi on the phone, access to the app "control" interface, click , either choose to download the picture and video from SD card or app album :

- ① Download the picture and video from SD card, click , choose files and click  save to the mobile album.

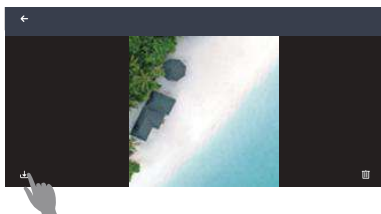
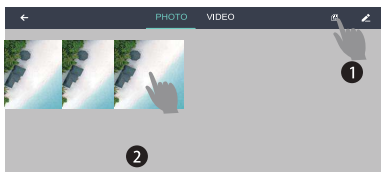

- ② Download the picture and video from app album, choose files and click  to save to mobile album.

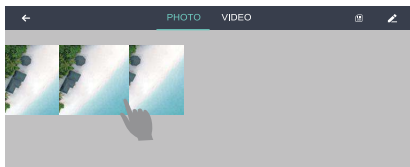

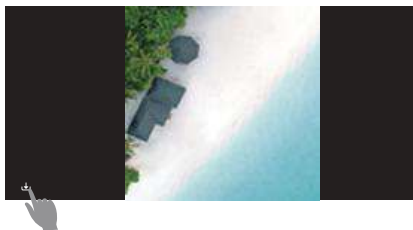

- Take out the SD card from drone, insert the card into a card reader and read the data on computer, download the video and photo into a computer.

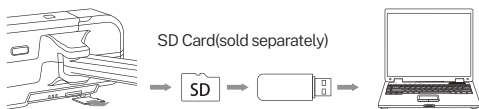

**⚠ • Video be stored in the app album will be compressed, thus always suggest to download the video from the SD card to get the best resolution.**

## 14 Flight

### 14.1 Takeoff/Landing Procedures

- Place the drone in an open, flat area, remove the gimbal cover.

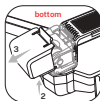
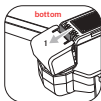

- Power on the remote controller and the drone.
- Wait until the remote controller and drone connected, connect the app, complete the calibration process.
- Keep the drone camera facing forward, start the motors.
- Gently push the throttle joystick up to take off.
- Pull the throttle joysticks down to land the drone.
- Stop the motors after landing.
- Power off the drone remote controller, replace the gimbal cover.

### 14.2 Quick Start

- Step 1: Turn on the controller**

Power on the controller, lift up the antenna to receive signal.



- Step 2: Turn on the drone**

Remove the gimbal cover gently, place the drone on a level surface, power on the drone. All lights blinking red. Drone and remote controller connects successfully, all lights flashing white and blue then turn to flashing white and pink.

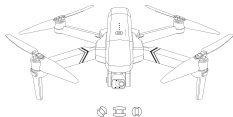

 • This connect process take around 40seconds.

- **Step 3: Connect the app**

Open the phone's WiFi list, connect the drone's WiFi which names "**RUKO-GIM-XXXX**", open the "RUKO DRONE" app.



- **Step 4: Complete compass calibration**

Pick up the drone and hold it level, rotate the drone in one full circle (360°), until hear a "beep" sound reminder. Hold the drone vertically with camera facing to the sky, rotating a full circle (360°), there are two "beep" sound reminder.

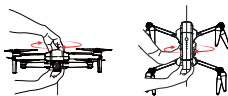

- **Step 5: Complete the gyroscope calibration**

Put the drone on a level surface, push the left and right joysticks to the 11' and 1' o'clock positions, lights flashing white and blue quickly.



- Drone searches for GPS signal automatically, when lights turn to solid blue and white, drone is ready to fly.
- App drone status: "Fly" is displayed in the app, drone is ready to fly.

**⚠️ • When it is needed to manually trigger the compass calibration to adapt to the environment, please push the joystick to 1 & 11 o'clock position, follow the above steps to rotate the drone.**



### • Step 6: 3 Ways to land the drone



Press the RTH button , drone will return to the Home Point.

Press the land button  on the app, the drone will land directly.

Keep pulling Throttle Joystick down until the drone lands and motors stop.



**Always keep the head of drone facing forward**

 **If the drone keep searching for GPS but no success because of weak GPS signal, keep pressing the  button to turn off the GPS Mode and switch to Manual Control mode, so that it is able to get the drone take-off. However, under Manual Control mode, there is high risk that the drone will fly away with the wind, as no GPS positioning assisted.**

## 15 Specifications

### 15.1 Drone

- MODEL: F11 GIM2
- Weight (Including Battery): 585g/20.6oz
- Flight Time: About 28 mins
- Motor Model: 1806
- Operating Temperature Range: 32° to 104° F ( 0° to 40° C)
- Satellite Systems: GPS/GLONASS
- Dimensions (LxWxH): Unfolded: 45X40.5X8(cm)  
Folded: 17.6X10.5X8(cm)

### 15.2 Gimbal Stabilization

- Mechanical Range: Tilt About -100°TO+70°, Roll About -35°TO+35°
- Controll Range: Adjusted angle of camera (up and down): About -80° TO+0°

## 15.3 Camera

- Lens:FOV: 100°
- Equivalent Focal Length: 60CM
- Focus range: Fixed-focus
- Resolution of photo: Phone 3840X2160P  
SD card 3840X2160P
- Resolution of video: Phone 1280X720P  
SD card 3840X2160P
- Photo Format: JPEG
- Video Format: MP4
- Supported File Systems: FAT32
- Supported SD Cards: Micro SD card (Class 10/U1 or later) 32G-128G



## 15.4 5G Transmission

- Operating Frequency: 5.15-5.35 GHz; 5.725-5.825 GHz
- Supported Transmission Protocol: 802.11a; 802.11n20; 802.11n40
- Video Transmission Frame Rate: 30FPS

## 15.5 APP / Live View

- Mobile App: RUKO DRONE
- Live View Quality:

CONFIGURATION	STORAGE METHOD		RESOLUTION	TRANSMISSION FRAME RATE
4K	Phone	Photo	3840X2160P	30fps
		Video	1280X720P	
	SD card	Photo	3840X2160P	30fps
		Video	3840X2160P	

- **Required Operating System: IOS 9.0 or later/Android 5.0 or later**

## 15.6 Remote controller

- Operating Frequency: **2.4G + 5G bridge**
- Max operating distance: Up to 3KM (Outdoor and Unobstructed)
- Battery: 1500mAh Li-polymer
- Charging time: about 2 hours
- Operating time: about 2.5 hours
- Operating Voltage: 3.7V
- Mobile Device Holder: 4.7 "to 6.5" Smart Phones
- Operating Temperature: 32° to 104° F ( 0° to 40° C )

## 15.7 Intelligent Flight Battery

- Capacity: 2500 mAh
- Voltage: 11.1V
- Battery Type: Li-polymer
- Energy: 27.75Wh
- Net Weight: 195 g / 6.8 oz
- Max Charging Power: 15W
- Max Charging Time: About 4.5 hours (Depending on Charging Power)
- Charging Temperature Range: 32° to 104° F ( 0° to 40° C )

## 15.8 Charging cable: Type-C

- Compatible Charger (not included): Output current 5V/3A
- Rated Power: ≤15 W



## Common Problems and Solutions

Question	Reason	Solutions
The motors cannot be started	Weak GPS signal	Turn on the Aircraft in an open area with strong GPS signal
	The red light stays on	The Aircraft has low battery. Please charge the battery in time
	The pink light stays on	The compass is not calibrated. Please refer to the "Calibration Before Flight" section of the user manual
	The left and right joystick are not in place	Push the left and right joysticks simultaneously to 5 o'clock and 7 o'clock for 2 seconds
Unstable flight	Flying too low, affected by Aircraft airflow	Please fly the Aircraft above 9.84ft(3 meters)
	The gyroscope is not calibrated	Place the Aircraft on a horizontal surface and conduct gyroscope/horizontal calibration. Please refer to the "Calibration Before Flight" section of the user manual
	The propellers become deformed and incomplete	Replace the propellers with new ones
	GPS signal is unstable. Flying near buildings and in obstructed places	Please fly the Aircraft in an open area free of obstacles within the circle of radius 32.81 ft(10 meters)

Question	Reason	Solutions
Out of control, spinning around on its own, abnormal sound	The Transmitter signal is interfered or the Aircraft exceeds the range of remote control	Please fly the Aircraft outdoors without interference, and ensure that it is within a controllable range
	Compass interference	Please manually land the drone in time and calibrate the compass. Please make sure to fly away from the buildings, trees, power lines, and signal towers
	The propellers become deformed and incomplete	Replace the propellers with new ones
The camera is tilted/Gimbal is not working/ Can't adjust the camera angle	The drone was placed on an unlevel surface such as grass and sand and so on	Place the drone on landing pad or cardboard horizontally, and ensure a gap between the camera and the surface
	The drone was placed on the surface which transfer small vibration, such as hollow wooden floor, desk and so on	Place the drone on a solid level ground
	Keep touching the camera and gimbal or holding the drone before all set	Never touch the camera when the power is on, place the drone on a level ground until the gimbal complete self-check
	The compass is in calibrating	After complete the compass calibration, place the drone on a level ground

Question	Reason	Solutions
Video freezes, image transmission distance is short	The Aircraft is out of Wi-Fi range	Fly the Aircraft within the range of the Wi-Fi
	WiFi image transmission signal interference	Fly the Aircraft in an unobstructed open area free of buildings, high-voltage wires and signal towers
	The transmitter and the mobile phone are not pointed at the direction of the drone	Point the Transmitter and the mobile device at the flying direction of the Aircraft to maintain the strongest signal connection
	Phone performance freezes	Close unused apps running in the background to maintain the best performance of the phone
Video is not clear	If use APP storage, the pixels are 1920×720P	Insert the memory card and storage the video on the memory card
App does not show what the drone's camera is taking	The phone is not connected to the drone's Wi-Fi	Connect the drone's Wi-Fi : Ruko-GIM-***** on the phone
	The phone operating system version is too low	The required device operating system to work with the app is Android 6.0 and above, IOS 10.02 and above
	Certain phones' setting preventing the app working normally	Set the phone to airplane mode
	The VPN app block the connection of the phone and the drone	Turn off the VPN
	Didn't keep the drone's network when trying to connect the drone's WiFi	Please do keep the drone's WiFi connected when the phone pop up reminder that "This network has no internet access"

Question	Reason	Solutions
APP crashes or functions abnormally	Wrong app downloaded	Download the correct App
	A few mobile phone versions are old and incompatible with APP	Provide mobile phone version and model, we will adapt and solve it
Phone cannot connect to the drone's Wi-Fi	It will take longer time for certain phone to connect with the drone's Wi-Fi for the first time	Try several times or restart the phone
The drone's WiFi name is not displayed in the list	WiFi has not been activated	The WiFi will be available when the drone and the transmitter connected, which take around 40 seconds
GPS signal is weak	Turning on the drone indoors	GPS signals cannot be found indoors. Please search for GPS signals in an open place outdoors
	Under the tree, next to the building, in an obstructed place	Please stay away from obstacles for more than 32.81 feet(10 meters), and search for GPS signals in an open area
Unable to return home, drifting and flying away	GPS signal was turned off during the flight	Please don't turn off GPS suddenly during outdoor flight. Switch back to GPS mode in time
Cannot charge battery/Cannot fully charge battery	Using inferior charger or charging on the computer with unstable voltage output	Use a mobile USB charger that ensures constant stable voltage output(5V) and amperage output(2-3A)
	Using inferior charging cables	Please use the original factory charging cable to charge

Question	Reason	Solutions
Short battery life	Flying in windy weather	Flying in windy weather will accelerate power loss
	Flying in cold weather	In low temperatures, the chemical reaction of the lithium battery is slowed down and the energy cannot be fully released
	The battery is not fully charged	Fully charged with the correct USB charger before flying
The product has slight marks	We tested all Aircraft before shipping	In order to give you the best experience, we tested functions of all Aircraft before shipping. Therefore, it is inevitable that there will be slight traces. However, it can be guaranteed that all Aircraft are 100% brand new

## 17 Accessories Support



Battery



Propeller



Landing Gear



Arm



Transmitter

All of the above accessories can be searched and purchased on Amazon, and you can enter the Ruko store to buy them yourself. Be sure to use original accessories. The use of non-original accessories may cause danger to the safe use of the aircraft.



## CONTACT US FOR MORE TECH SUPPORT

Printed in China.

Ruko Tech Support  
<https://rukotoy.com/support-drones>

This User Manual is subject to change without notice.

**You can check the recently updated version of "User Manual"  
on Ruko's official website**  
<https://rukotoy.com/support-drones>

If you have any questions or suggestions about the User Manual,  
please contact us via the following email:  
[rukobrandstore@gmail.com](mailto:rukobrandstore@gmail.com)

Ruko is a trademark of Shenzhen Ruike Innovation Technology Co.,Ltd  
Copyright 2023 Ruko All Rights Reserved.

# *Ruko*<sup>®</sup>

rukotoy.com

CONTACT US FOR MORE TECH SUPPORT



+1 (888)892-0155 | Mon-Fri 7:00AM - 7:00PM (PST)



+86 19129317359



rukobrandstore@gmail.com

