

Ruko[®]

14+
for age

User Manual

v3.0

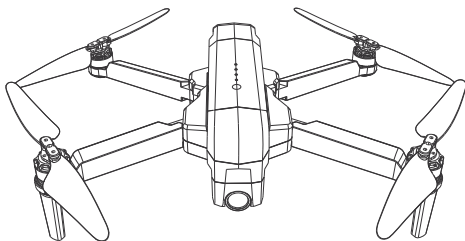

F11PRO

CONTACT US FOR MORE TECH SUPPORT

 +1 (888)892-0155 | Mon-Fri 7:00AM - 7:00PM (PST)



rukotoy.com

CONTACT US FOR MORE TECH SUPPORT



+1 (888)892-0155 | Mon-Fri 7:00AM - 7:00PM (PST)



+86 19129317359



Disclaimer and Safety Guidelines - - - - - 1-7

User Manual - - - - - 10-55

Safety at a Glance

 The Ruko F11 PRO is NOT a toy and is NOT suitable for people under the age of 14.

1. Glossary

- The following terms are used throughout the product literature to indicate various levels of potential harm when operating this product:



Recommend



Warning



Hints & Tips



Reference

2. Disclaimer and Warning

- This product is NOT a toy and is NOT suitable for people under the age of 14. Keep the aircraft out of the reach of children and exercise caution when operating this aircraft in the presence of children.
- This product is a flying camera that offers easy flight when in good working order as set forth below. Read the materials associated with the product before using it for the first time. These documents are included in the product package.
- Inappropriate use of the product could result in personal injury or property damage.
- The information in this document affects your safety and your legal rights and responsibilities. Read this entire document carefully to ensure proper configuration before use. Failure to read and follow the instructions and warnings in this document may result in product loss, serious injury to you, or damage to your aircraft.
- By using this product, you hereby signify that you have read this disclaimer carefully and that you understand and agree to abide by the terms and conditions herein. Please be sure to strictly abide by the specification requirements and safety guidelines stated in this document.
- You agree to use this product only for purposes that are proper and in accordance with local regulations, terms and all applicable policies and guidelines.
- Any personal injury property damage, legal disputes and all other adverse events caused by the violation of the safety instructions or due to any other factors, WILL NOT be Ruko's responsibility.

3. Flight Environment Requirements

- Fly in an open field far away from densely populated areas, residential surroundings and electromagnetic interference sources. When flying in areas below 2000 meters above sea level, please be at least **3 meters** above the water when flying on the water.

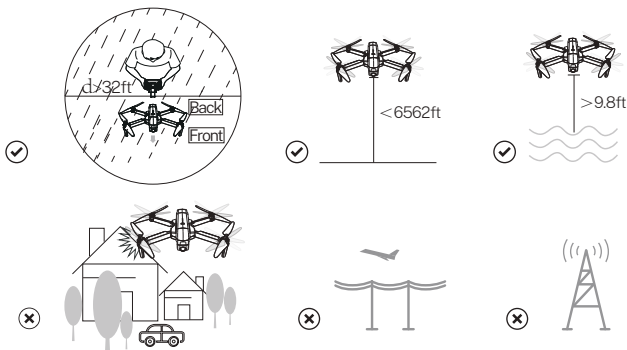

-
- ⚠ • The compass and GPS signals on the aircraft will be interfered by buildings, mountains, and trees.
- It is recommended to fly in an open space with a diameter of 10 meters without interference.
 - The flying height must be **higher** than the obstacles on the ground to avoid collision.
 - It is recommended that the flight altitude be greater than **15 meters** to avoid other signal interference from the ground.
 - Electromagnetic interference sources include, but are not limited to: high-voltage power lines, high-voltage power transmission stations, mobile phone base stations and TV broadcast signal towers, Wi-Fi hotspots, routers, and Bluetooth devices. Must fly away from electromagnetic interference sources.
-

- Fly in an environment of 0°C to 40°C and good weather (not rain, fog, snow, thunder and lightning, strong wind, or extreme weather).





- It is forbidden to fly indoors. Please do not fly in the no-fly zone and comply with local laws.

4. Pre-Flight Checklist

- Ensure that the arms of the aircraft are fully extended. Make sure that the battery compartment cover is fastened firmly and the intelligent flight battery is installed firmly.
- Ensure that the propeller is free from damage, aging, deformation, no foreign matter entanglement, and firm installation.
- Please make sure that GPS is turned on to avoid that it would be lost please fly outdoor in an open place.
- Turn on the aircraft, then turn on the transmitter, please pair it with the aircraft.
- Connect Aircraft's Wi-Fi with your phone, make sure that you have connected the Wi-Fi name "RUKO-PRO-XXXXXX" exactly after App access right and Internet permission with your phone, please make reference to operation video on App first before flying.

5. Flight Operations

- **Keep away from propellers and motors that are working and rotating.** Fly in a non-interference environment and within line of sight (VLOS).
- Do not make calls or send text messages during the flight.
- When the GPS signal is poor, please return as soon as possible when the battery is low or the wind is warning.

- The aircraft is not equipped with obstacle avoidance function. During the flight, please judge the flight status reasonably, avoid obstacles in time, and set the corresponding flight and return altitude according to the flight environment.
If the aircraft drifts during flight and cannot hover steadily, please land the drone and re-calibrate the compass before taking off.

6. Instructions for Using Intelligent Flight Battery and Warning

- It is recommended to charge and discharge it once a month, do not store it fully charged, keep 50%-60% of the electricity, the storage temperature is 10-40°C, and the best storage temperature is 19-21°C.
- Water enters the battery and the battery protection board fails, which will cause the battery to not be used normally. Do not use the battery in rain or in a humid environment, as this may cause the battery to self-ignite or even explode.
- If the battery is squeezed, deformed and dropped from a high altitude, it is forbidden to use it again.
- Prohibition of prolonged high-temperature exposure. The high temperature of the battery will cause the internal pressure of the battery to be too high and cause an explosion.
- The positive and negative poles are short-circuited for a long time (such as the short-circuit caused by the water coming out of the battery contacts, the foreign matter in the hair, etc.). If it exceeds 30 minutes, the protection board IC will fail and disconnect, and the battery will not work normally.
- DO NOT use fast chargers that exceed the rated power of the battery when charging. It is recommended to use 5V/2A or 5V/3A chargers, do not use more than 5V/3A chargers.
- If the aircraft has not been used for a month, the battery must be removed to prevent the battery from being in a long-term low-power discharge state.

- ⚠️ • Use 5V/3A charging plugs. Fast charging plugs exceeding 5V/3A are prohibited.



- It is prohibited to use computer USB, simple USB, and inferior charging cables for charging.

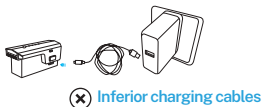
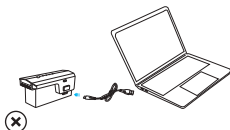

- Please remove the battery in time after the aircraft has landed on low power to avoid battery damage caused by battery over-discharge.
- It is forbidden to overcharge the battery, please remove charging cable in time after fully charged to avoid damage due to over-charge.

✓ Charging Time≈5 hours



✗ Overcharge>5 hours



- **DO NOT charge the battery immediately after the flight as the temperature may be too high.** Wait until it cools down to room temperature before charging again. Due to the battery current output, slight hotness is normal while flying.



7. Problems You May Encounter

1. To Prevent Flying Lost

1) It is better for beginners to fly the aircraft within real-time image transmission range on your phone's APP for safety.

2) **During flight, DO NOT turn off GPS signal** (Do not long press this button on the left upper corner  , otherwise GPS will turn off), the aircraft would fly unsteadily, or lose the direction or will be lost completely.

3) During flight, if picture freezes, the reason is Wi-Fi disconnection, please RETURN THE DRONE first, change to another new environment or check if there is interference around, then connect again.

4) This button on the right upper corner  after long pressing is only for emergency stop.

DO NOT use it casually while flying, otherwise it will crash.

2. Camera Guidelines

1) Do not place the aircraft on rough ground and turn on, coz camera will adjust up and down for self-calibration, please place it in a **horizontal position** to make sure there is **enough gap under the camera**, otherwise camera would be stuck.

2) If camera is stuck, please place the drone on horizontal position without obstacles and restart the aircraft. then check if it can make self-calibration, or make avroscope calibration to check camera self-calibration.

3) If not, turn off the aircraft, then move camera up and down by hand. If still stuck, please contact us for technical support.

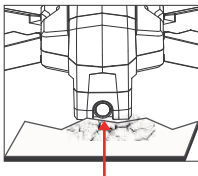

Rough ground

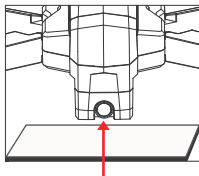

large gap

3. Wi-Fi Guidelines

1) For Android phones, after connection with aircraft's Wi-Fi RUKO-PRO-XXXXXX, please wait for about 10-40 seconds, note if there is any option popping up about Internet settings, make sure connected, otherwise, there is no picture after entering APP.

2) If still without Wi-Fi connection, please turn on your phone's airplane mode and connect drone's Wi-Fi.

3) The phone WLAN compatible with this drone must support dual-band Wi-Fi (2.4 and 5G).



4. Remote Controller Guidelines

After a full charge, if it shows a low battery on App, please remember to pair the remote controller first with the drone, then connect Wi-Fi and enter the App to check. If there are other problems, please get in touch with technical support.

5. Return within 30 meters

If it's one button return, it flies back above its original take-off point directly. If return by low battery, it flies back due to current height, this can not be cancelled.

CONTACT US FOR MORE TECH SUPPORT

Please go to the front of the User Manual for contact in formation.

Printed in China.

Contents

1 Using This Manual	10
1.1 Legend	10
1.2 Read Before the First Flight	10
1.3 Download the Ruko Pro APP	10
1.4 Video Tutorials	10
2 Product Profile	11
2.1 Important	11
2.2 Product List	11
2.3 Preparing the Aircraft	12
2.4 Aircraft Diagram	12
2.5 Transmitter Diagram	13
3 Aircraft	15
3.1 Three Gears Speed of the Aircraft	15
3.2 Calibration and Aircraft Status Indicator	16
3.3 Return to Home	17
3.4 Intelligent Flight Mode (Waypoint / Follow / Surround / Gesture)	21
3.5 Propellers	24
3.6 Intelligent Flight Battery	25
3.7 Camera Overview	28

4 Transmitter	29
4.1 Transmitter Profile	29
4.2 Using the Transmitter	29
4.3 Communication Range of Transmitter	35
4.4 Linking the Transmitter	36
5 Ruko Pro APP	36
5.1 Home	36
5.2 Camera View	37
6 Flight	42
6.1 Flight Environment Requirements	42
6.2 Pre-Flight Checklist	43
6.3 Calibration Before Flight	43
6.4 Starting/Stopping the Motors	48
6.5 Automatic Take-off / Automatic Landing	49
6.6 How to take off the Ruko F11 PRO Drone	50
6.7 Aerial Photography Tips & Tricks	51
7 Appendix	52
7.1 Specifications	52
7.2 Accessories Support	54
7.3 Common Problems and Solutions	55

1 Using This Manual

1.1 Legend

☑ Recommend ⊗ Warning ⚠ Hints & Tips 📖 Reference

1.2 Read Before the First Flight

- Read the following documents before using the Ruko F11 PRO
 - ① User Manual
 - ② Quick Start Guide
- It is recommended to watch all tutorial videos on the official website and read the Disclaimer and Safety Guidelines before using for the first time. Prepare for the first flight before reviewing the Quick Start Guide and refer to this User Manual for more information.

1.3 Download the Ruko Pro APP

- Make sure to use Ruko Pro App during the flight. Scan the QR code on the right to download the latest version of the app.
- Ruko Pro App supports Android 6.0 or higher, iOS 10.0.2 or higher, dual-band wifi (2.4GHz) and 5.8GHz phones.



1.4 Video Tutorials

- Visit the following link to watch the tutorial videos to ensure correct and safe use of the product.
<https://www.ruko.net/pages/video>



2 Product Profile

Thank you for purchasing from Ruko. Please read all instructions and warnings carefully before operating. Please also keep this instruction manual for future reference and maintenance.

2.1 Important

- The Ruko F11 PRO is NOT a toy and is not suitable for people under the age of 14.
- It requires correct assembly and debugging to avoid any accident before every flight. Inappropriate use of the product could result in personal injury or property damages.
- In the event of a problem during use, operating, or maintenance, please feel free to contact the Tech Support rukodrone@gmail.com.

2.2 Product list



Drone



transmitter



Battery



Screwdriver

USB Charging Cable
(charger not included)

Screw



Propeller



User Manual



Quick Start Guide

2.3 Preparing the aircraft

All aircraft arms are folded before the aircraft is packaged. Follow the steps below to unfold the aircraft arms.

- Unfold the front arms

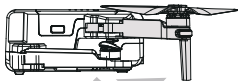

- Unfold the rear arms and then unfold all the propellers

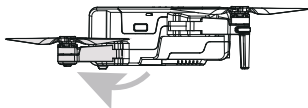

- ⚠ • Unfold the front arms before unfolding the rear arms.
- Before powering on the aircraft, ensure that the front and rear arms are extended and the camera is placed on the horizontal ground. Ensure that there is sufficient space under the camera to prevent the camera angle from being stuck to the ground during the self-check.

2.4 Aircraft Diagram

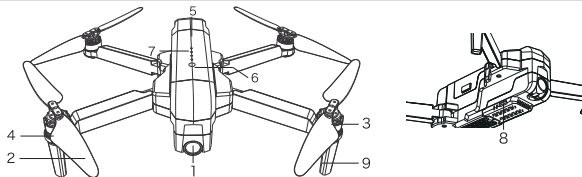

- | | |
|----------------------------|-----------------------|
| ① High-definition Camera | ⑥ Power Button |
| ② Propellers | ⑦ Battery Level Leds |
| ③ Motor (Pointing Unclear) | ⑧ Camera SD Card Slot |
| ④ Led Indicator Light | ⑨ Landing Gear |
| ⑤ Flight Battery | |

2.5 Transmitter Diagram

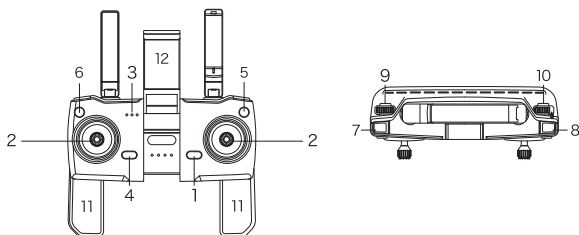

① Power Button

Short-press once to start; Short-press + long-press for more than 2 seconds to turn off the transmitter;

② Control Sticks

(American control sticks) Use a control stick to control aircraft movements. The left control stick is the throttle lever, which can adjust the aircraft's altitude and nose direction. The right control stick is a directional stick that controls the aircraft's flight direction (forward / back / left / right). The Japanese hand's control stick functions in reverse to the American control sticks;

③ Battery Level LEDs

Displays the current battery level of the transmitter. a) Turn on the power, and the white light blinks. b) Push the left control stick up and down to pair the transmitter with the aircraft, and the white light is steady on. c) Blinking white light during flight indicates the battery of the transmitter is low.

④ Press Smart RTH Button

Press the button to let the aircraft automatically return to the take-off position. Due to GPS signal problems (commercial class), the landing position may be slightly different from the take-off position. The deviation range is about 10 feet(3 meters) in diameter. Press the RTH button once again to cancel the intelligent return.

⑤ Emergency Landing / One-button Automatic Hover / One-button Landing

Press and hold the button for 3 seconds to make the aircraft land in an emergency effective within 49.21 feet(15 meters height). **After pressing the emergency stop button, the aircraft will lose power and fall out of the sky directly. It is recommended to use it only in an emergency to avoid loss.**

One-click takeoff: after unlocking the motor, press one button to automatically take off up to a height of about 4.92 feet(1.5 meters).

One-click landing: Press one button to land the aircraft in flight and the aircraft will descend to the ground at the existing coordinates.

⑥ Turn on/off GPS; The Headless Mode

Not taking off: long press for 3 seconds to turn off GPS.

GPS mode in flight: Turn off the GPS during flight, the command will not take effect, and it will take effect and turn off GPS after the aircraft lands.**(Do not turn off GPS when flying outdoors in case the aircraft is lost)**

Click the button once to activate the headless mode. In the headless mode, please remember the orientation of the aircraft camera during takeoff. No matter what direction the aircraft camera will be facing during flight, the orientation of the camera during takeoff is always the forward direction of the remote-control stick. Click the button again to turn off headless mode.

⑦ Shutter Button

Press once to take a picture.

⑧ Record Button

Press once to start recording, and press again to stop recording.

⑨ Adjust the Aircraft Speed

Turn the right wheel to the left to reduce the aircraft's speed; Turn the wheel to the right to accelerate the aircraft.

⑩ Adjust the Camera Angle

Rotate the left wheel to the left to adjust the camera lens to point downwards; Rotate the wheel to the right to adjust the camera lens to point upwards.

⑪ Mobile Device Clamps

Push outwards to open the two mobile device clamps of the transmitter for easy manipulation of the control stick of the transmitter.

⑫ Mobile Phone Holder

Flip up to open the holder for placing mobile devices. The width of the phone holder is adjustable. The maximum adjustable width is up to 3 inches.

3 Aircraft

F11PRO aircraft is mainly composed of a flight controller, communication system, video downlink system, propulsion system, and an intelligent flight battery.



3.1 Three Gears Speed of the aircraft



- The F11PRO has three speed ranges: 14.76 ft/s, 29.53 ft/s, and 39.37 ft/s. The default speed is medium speed. Turn the speed wheel to the right to adjust the flight speed up to 39.37 ft/s, and turn the wheel to the left to slow the aircraft down to 14.76 ft/s, which provides a diverse flight experience and meets various needs with speed.

- ⚠️ • When wind speed is high, high-speed flight should be maintained to improve wind resistance effect.
- When flying with fast gear, the pilot should reserve at least **3 meters** of braking distance to ensure flight safety when flying in windy conditions.
- When using the fast gear for flight, the power of the aircraft will be greatly improved, and the operation of the remote lever on the transmitter will lead to the large flight action of the aircraft. During the actual flight, the pilot reserves enough flying space to ensure the safety of the flight.

3.2 Calibration and aircraft Status Indicator

- The F11PRO aircraft's status indicator is located above the nose landing gear to indicate the current status of the flight control system. Please refer to the following table for the status of the flight control system represented by different blinking modes.

Color of light	Blinking status of the indicator	Conditions
Front and rear red lights 	Continuous blinking of red light	The transmitter has not been paired with the aircraft (by pushing the left control stick up and down).
Four pink lights 	Blinking back and forth 3 times per second	Compass calibration is required.
The front is white and the back is blue 	Blinking slowly back and forth blinking twice per second	Aircraft low battery warning



Color of light	Blinking status of the indicator	Conditions
The front is white and the back is blue 	White and blue are blinking twice every second blinking once every second	Searching for GPS Blinking twice per second indicates GPS signal has not been found. Blinking once per second indicates that GPS signal is detected but the conditions for takeoff are not met.
The front is white and the back is blue 	White and blue are blinking fast	Gyroscope/level calibration is required.
The front is white and the back is blue 	White and blue always turn on	GPS signal is detected and take-off conditions are met.

3.3 Return to Home

The Return to Home (RTH) function brings the aircraft back to the last recorded Home Point. There are three types of RTH: Smart RTH, Low Battery RTH, and Signal Disconnection RTH. If you activate the RTH function under the condition that the aircraft successfully recorded the Home Point and the GPS signal is good, the aircraft will automatically return to the Home Point and land.

☰	GPS	Description
Home Point	Using five bars of signal	When flying outdoors, the GPS signal icon is displayed with 3 bars or more for the first time, and the take-off location will record the aircraft's current position as the Home Point. During the flight, if the aircraft lands at a new location, the point from which you retook off will become the latest Home Point, and the aircraft will return to the latest Home Point.

• Smart RTH

When the pilot needs the aircraft to return home automatically, he can click the smart RTH button on transmitter  or tap the return home icon  on the Ruko Pro APP to activate RTH.

-  • When the aircraft executes smart RTH **within a radius of 98 feet (30 meters)**, the aircraft will return from the **current altitude** to the take-off point. **(Pay attention to maintaining the flying height to avoid hitting people or obstacles)**

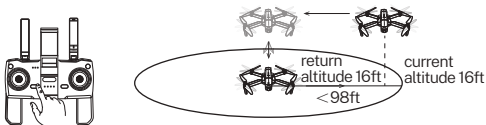

- ⚠️ • When the aircraft returns to the Home Point **beyond the 98 feet (30 meters) radius**, if the return altitude is **not set** and the aircraft is flying **below 65 feet(20 meters)**, it will **automatically fly up** to the default return altitude of 65 feet(20 meters) before returning home.

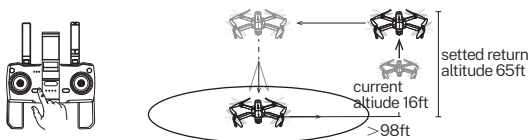

- ⚠️ • When the aircraft returns to the Home Point **beyond the 98 feet (30 meters) radius**, if the RTH altitude is **set** (before flight), the aircraft will ascend to the altitude already set before returning to the take-off point, if the current altitude of the aircraft is **lower** than the RTH altitude. The aircraft will return to the Home Point from the current altitude, if the current altitude of the aircraft is **higher** than the RTH altitude.

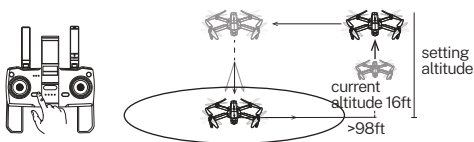

- The aircraft is not equipped with obstacle avoidance function. Please judge the flight status reasonably during the flight. Avoid obstacles in time, and set the corresponding flight and return altitude according to the flight environment.

• Low Battery RTH

When the intelligent flight battery is too low or there is not enough power to return home, the user should land the aircraft as soon as possible to avoid damage to the aircraft or other dangers.

In order to prevent unnecessary dangers due to insufficient battery power, when the aircraft battery power is low, the intelligent low battery return home function will be automatically triggered.

According to the remaining power after returning, there are 2 situations after returning:

① First-level low battery: the aircraft returns to the point 98 feet(30 meters) above the take off point and hover. After hovering, you can continue flying the aircraft at a height of 98 feet (30 meters) and within a radius of 30 98 feet(30 meters).

② Second-level low battery: the aircraft will fly directly from the current altitude to the point 98 feet(30 meters) above the Home Point and then descend to the ground.

 • **Must pay attention to the flight altitude when the battery is low. Avoid hitting obstacles due to the low flying altitude when returning home with the second-level low battery.**

- The remaining power after returning is related to the return distance, wind speed, and wind direction.
-

• Lost Signal RTH

When the transmitter has a low battery or is turned off or loses signal for 6 seconds, the aircraft will enter the auto-return mode and return to the take-off point. If the signal is recovered during the return home process, the aircraft will stop returning and rebind with the transmitter signal, and the transmitter can control the aircraft again at this time. Automatic Return to Home process when signal is lost

- ① aircraft stores its position when taking off after the GPS signal is successfully received, and records it as the Home Point;
- ② Trigger RTH (triggered by low battery of transmitter, signal loss, etc.);
- ③ After triggering the Return-to-Home function, the aircraft adjusts the nose direction and starts to return home;
- ④ The aircraft automatically flies to the top of the home point, then starts to land, and completes the home return;

3.4 Intelligent Flight Mode

F11 PRO has four intelligent flight modes: Route rules, follow mode, surround mode and gesture mode. According to the user's shooting needs, the operation can be completed by one click, which is simple and fast.

 Route rules: aircraft flies along the path marked on the app.

 Follow Mode: aircraft will lock onto the user and can track user's movement as he moves.

 Surround Mode: aircraft orbits around the point already set on the app at a certain distance.

 Gesture Mode: aircraft takes photos or videos according to the manipulation commands of different gestures.

• Route Rules

- ① Make sure you have downloaded Ruko Pro APP on your phone;
- ② Connect your smartphone to the aircraft's WiFi;
- ③ After the aircraft takes off, in GPS mode, tap on the app  ;
- ④ You can find a red circle on the map (limited flight range). Mark the points (up to 16) which you plan to fly the aircraft along within the circle;
- ⑤ If you want to reset the marked point or flight path, you can tap "Delete Single Point" or "Delete All";
- ⑥ Confirm that the marked points are correct and tap "Go" button. The aircraft will start Waypoint Flight.

 • Push the right joystick to cancel the waypoint flight function.

• Follow Mode

- ① Ensure that the Ruko Pro APP has been downloaded and installed on the smartphone;
- ② Turn on the GPS positioning of the smartphone to connect to the Aircraft's WiFi;
- ③ After the aircraft takes off in an open environment with good GPS signal, ensure that the flight range is within 32-164 feet(10-50 meters) for the best effect;
- ④ Tap the  icon on the APP interface, and then click the "GPS Follow" icon to enter the follow mode;
- ⑤ "Follow me mode is ready" will be displayed on the APP interface and the aircraft turns on the "follow mode" . The aircraft tracks your movement as you move.
- ⑥ Tap the icon on the APP interface again to exit the "Follow Me" mode.

 • The GPS follow-me function only works when the GPS signal is strong. Please avoid high buildings, trees, and areas where WIFI signal might be interfered.

- Aircraft is not equipped with obstacle avoidance function. Please use it in open areas free of obstacles.
-

• Surround Mode

- ① Make sure that the Ruko Pro APP has been downloaded and installed on the smartphone;
- ② Connect your smartphone to Aircraft's WiFi;
- ③ After the aircraft takes off, fly it in GPS mode;
- ④ Press the camera and video buttons on the transmitter at the same time to activate the "surround mode" and set the current position of the aircraft as the center point;
- ⑤ Move the direction joystick to set the flight radius of the aircraft (within the range of 6 -328 feet (2-100m)). Push the stick downwards to increase the flight radius and push the stick upwards to decrease the radius.
- ⑥ Press the camera and video buttons on the transmitter again, and the aircraft will start to fly around the radius set in step 3;
- ⑦ Move the direction joystick to cancel the point of interest mode.

 • If the surrounding radius is less than 6 feet (2 meters), the aircraft will automatically fly up to 6 feet(2 meters).

- Press the camera and video buttons at the same time to activate the "surround mode".

• Gesture Mode



- ① Make sure you have downloaded and installed the Ruko Pro APP on your smartphone;
- ② Connect your smartphone to aircraft's WiFi;
- ③ After the aircraft takes off, use it in GPS mode;
- ④ Open the APP, tap the  button on the APP interface, and tap the "Ges photo" button. In this mode, raise your right hand to shoulder height and make a "scissors hand" pose to take pictures;
- ⑤ Tap the "Ges record" button. In this mode, raise your right hand to shoulder height and show your palm to the camera to turn on the recording mode.

 • Use the mode in a well-lit environment. Tap the button again to exit the gesture mode.

- Gesture mode can only be activated with the right hand.
-

3.5 Propellers

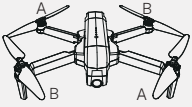
The propellers on the adjacent motors of the F11 PRO are forward and reverse propellers. The two propellers on the same motor are the same, and the propellers are marked with A and B respectively. The rotation directions of the propellers with the same mark are different.

Propellers	Mark A	Mark B
		
Installation location	Installed to the motor with A mark on the arm	Installed to the motor with B mark on the arm

• Attaching the Propellers

Taking the camera direction as the front, the left front arm and right rear arm must be equipped with propellers marked with A; the right front arm and left rear arm must be equipped with propellers marked with B. Use a screwdriver to install and make sure the screws are tightened.

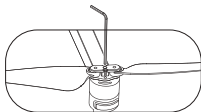

• Detaching the Propellers

Use the screwdriver to detach the propellers from the motors.

- Please use the propellers provided by Ruko, and do not mix propellers of different types.
- ⚠️ • Please check whether the propeller is installed correctly and tightly before each flight.
- Before each flight, please check to make sure that the propellers are in good condition.
- Make sure that the ESC emits a tone after the aircraft is powered on.

3.6 Intelligent Flight Battery

The F11PRO intelligent flight battery has a capacity of 2500mAh, a rated voltage of 11.1 V, and with charge and discharge management functions. This battery uses high-energy and large-capacity batteries to increase the flight time of the aircraft.

⚠ • Please read carefully and strictly abide by Ruko's Requirements in this Manual, Disclaimer and Safety Summary, and stickers on the battery surface before using the battery. The user shall bear the consequences caused by failure to use it as required.

• Using the Battery

Install the Intelligent Flight Battery into the battery compartment and push it down until you hear a "click" from the battery buckle, indicating that it pops up and locks. Make sure the battery is in place.

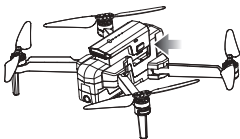

To remove the battery, press the buckles on both sides of the battery and pull it out of the battery compartment.

-
- ⚠ • Do not install the battery into the aircraft or remove the battery from the aircraft when the battery power is turned on. Otherwise, the poor contact of the battery interface during the operation may cause the battery to short-circuit and burn the aircraft. The battery must be installed or removed with the battery power turned off.
-

• Checking Battery Level

Press and hold the power button, after the indicator light turns on to the fourth, and release the power button to check the current battery level.

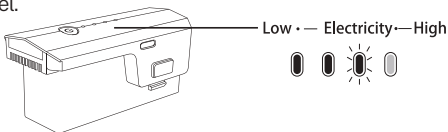

• Powering On

Press and hold the power button for 3 seconds, release the power button after the indicator light turns on to the fourth. When turned on, the power indicator shows the current battery power.

• Powering Off

Press and hold the power button for 3 seconds, release the power button after all the indicator lights are off; after turning off, the indicator lights are all off.

• Low Temperature Notice

When using the battery in a low temperature environment (0°C to 5°C), make sure that the battery is fully charged. The discharge capacity of the battery will be reduced when working in a low temperature environment. In a low temperature environment, due to the battery output power limitation, the aircraft's wind resistance and flight performance will be reduced. Please be careful. **You need to be extra cautious when flying in low-temperature and high-altitude environments.**

• Charging the Battery

Before using the Intelligent Flight Battery, be sure to fully charge it. Please use a 5V/3A USB charging plug.

In the charging state, the battery power indicator will flash and indicate the current charge level; when the fourth indicator light is always on, it indicates that the charging is complete.

After charging is complete, please remove the charger in time.



• Daily Preservation Advice

It is recommended to charge and discharge it once a month, do not store it with a full charge, keep 50%-60% of the power, the storage temperature is 10-40°C, and the best storage temperature is 19-21°C. If water enters the battery and the battery protection board fails, the battery cannot be used normally. Do not use the battery in rain or in a humid environment, as this may cause the battery to self-ignite or even explode.

If the battery is squeezed, deformed and dropped from a high altitude, it is forbidden to use it again.

Prolonged exposure to high temperatures is forbidden. High temperatures will cause the internal pressure of the battery to become too high and cause an explosion.

The positive and negative poles are short-circuited for a long time (such as water coming out of the battery contacts, short-circuiting caused by foreign objects in the hair, etc.). If it exceeds 30 minutes, the protection board IC will fail and disconnect, and the battery cannot be used normally.

It is forbidden to use fast chargers that exceed the battery's rated power for charging. It is recommended to use a 5V/2A or 5V/3A charger. If the aircraft has not been used for a month, the battery must be removed to prevent the battery from being discharged for a long time.

3.7 Camera Overview

• Camera overview

The camera uses an upgraded 5GHz Wi-Fi FPV real-time transmission function, equipped with a 120°FOV lens and a 90°adjustable camera, which can stably shoot 4K HD video and 4K ultra-clear images, providing you with a broad field of vision for unforgettable moments.

• Camera Guideline

Do not place the aircraft on rough ground and turn it on, because the camera will adjust up and down for self-calibration. Please place it in a horizontal position to ensure that there is enough clearance under the camera, otherwise the camera will get stuck. If the camera is stuck, please place the aircraft in a horizontal position with no obstacles, restart the aircraft, and then check whether it can perform self-calibration or gyroscope calibration, and check the camera's self-calibration. If not, turn off the aircraft and move the camera up and down by hand. If it is still stuck, please contact us for technical support.

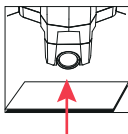

✓ large gap

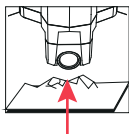

✗ Rough ground

• Storing Photos and Videos

F11 PRO is equipped with a micro SD card slot for storage space expansion.

Card speed: 10M/s;

File format: support FAT32 format;

Memory capacity: a memory card with a memory capacity of 32G or less.

The phone and the memory card store photos and videos at the same time. If you want a clearer video, please download the video files in the memory card.

- ⚠️ • Check whether the capacity of the memory card is sufficient. If the capacity of the memory card is insufficient, videos and pictures cannot be stored.
- If you cannot save pictures or videos, try formatting the memory card.
- Do not insert or remove the micro SD card when the aircraft is turned on. Plugging or unplugging the micro SD card or removing the battery while the power is on during recording may cause damage to the micro SD card and loss of stored data.
- You must turn on the aircraft and connect to the aircraft WiFi to copy or download the photos or videos stored in the aircraft memory card to the phone.

4 Transmitter

4.1 Transmitter Profile

- F11 PRO transmitter uses the 2.4 GHz frequency band, and the transmitter distance is up to 4000FT (unobstructed and interference-free environment). The foldable handle can stably place the mobile device, and the maximum adjustable width is 3.1 inches.
- transmitter built-in 300mAh capacity battery, charging time is 40 minutes, the longest working time is about 10 hours.

4.2 Using the Transmitter

- Press the power button once to turn on the transmitter. Hold press to turn the transmitter on or off. If the battery level is too low, charge before use.

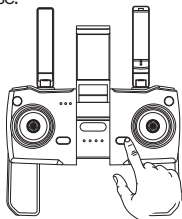

• Charging the Battery

Connect the transmitter Type-C interface to the charger for charging. It is forbidden to use fast chargers that exceed the rated power of the battery. It is recommended to use 5V/2A or 5V/3A chargers, do not use more than 5V/3A chargers.



Transmitter's light description

- ① Green light on: Charging is complete
- ② Red light on: Charging
- ③ Power light:
 - a. The white light flashes when the power is turned on, and the white light is always on after the left joystick is pushed up and down to unlock the link.
 - b. Blinking during flight indicates that the transmitter is low power.
- ④ GPS/return to home light:
 - a. Turn off the GPS and the light goes out.
 - b. Return home: flashing + DI, DI sound
- ⑤ Speed light:
 - a. Low gear: off.
 - b. Medium-speed gear: always on.
 - c. High-speed gear: flashing
- ⑥ Photos/videos:
 - a. Take pictures: Press once to blink +DI sound.
 - b. Video: Always flashing + Didi sound
- ⑦ Headless mode:
 - a. Turn on the headless mode;
 - b. Turn on the blue light.

⚠ • The transmitter cannot be turned on during charging, and the transmitter can be turned on after unplugging the charging cable.

- **Controlling the Camera**

Video Button: Press once to switch to video recording mode or start/stop recording.

Photo Button: Press once to take a photo.

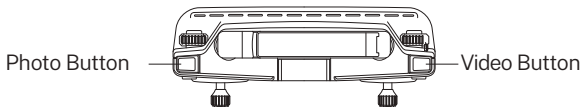



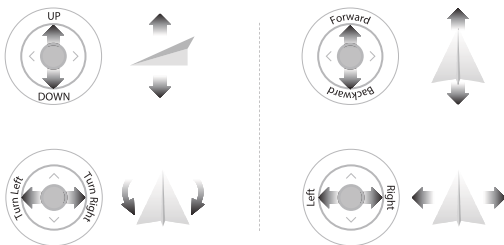

- **Joystick Control Aircraft**

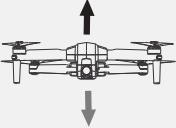
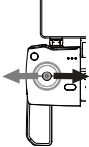
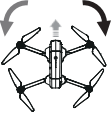
The control method of the transmitter joystick is as follows:

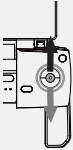

Transmitter (Default Mode)	Aircraft Direction
	
Remarks	
<p>Push up/down the throttle stick to control the aircraft up and down.</p> <p>Push up and the aircraft rises. Pull down the lever and the aircraft lowers. When released, the joystick is in the middle position and the aircraft remains hovering.</p> <p>When the aircraft takes off, the throttle lever must be pushed up and the aircraft takes off off the ground (please push the stick slowly to prevent the aircraft from suddenly rush up).</p>	
Transmitter (Default Mode)	Aircraft Direction
	
Remarks	
<p>Push the throttle stick left/right to control the aircraft heading.</p> <p>Push the stick to the left and the aircraft will rotate counter-clockwise. Push the stick to the right and the aircraft rotates clockwise. In the neutral position, the angular velocity of rotation is zero, and the aircraft does not rotate.</p>	

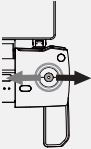
Transmitter (Default Mode)	Aircraft Direction
 A line drawing of a transmitter's control stick and direction bar. The direction bar is a vertical lever with a small rectangular tab at the top. The stick is a circular joystick with a central button. The direction bar is positioned to the right of the stick.	 A top-down view of a quadcopter drone. A vertical double-headed arrow is centered on the drone, indicating its forward and backward flight directions.
Remarks	
<p>Push up/down the direction bar to control the aircraft to fly back and forth.</p> <p>Push the stick up and the aircraft leans forward and flies forward. Pull down the lever, the aircraft tilts backwards and flies backwards. The aircraft's front and rear directions remain level in the neutral position. The joystick offset corresponds to the angle of the aircraft's front and rear tilt. The greater the offset, the greater the tilt angle and the faster the flight speed.</p>	

Transmitter (Default Mode)	Aircraft Direction
	
Remarks	
<p>Push the direction stick left/right to control the aircraft to fly left and right.</p> <p>Hit the stick to the left, the aircraft tilts to the left and flies to the left. Hit the stick to the right, the aircraft tilts to the right and flies to the right. The left and right directions of the aircraft remain horizontal in the middle position.</p> <p>The joystick offset corresponds to the angle of the aircraft's left and right tilt. The greater the offset, the greater the tilt angle and the faster the flight speed.</p>	

- ⚠️ • The forward direction of the aircraft is based on the direction of the nose.

• Smart RTH Button

Tap the Smart RTH button on the transmitter, and the aircraft will activate the automatic return home function. Tap it again to exit the smart return home. The aircraft is hovering in the mid-air of the return home. At this time, you can operate the joystick to control the aircraft.

4.3 Communication Range of transmitter

- When controlling the aircraft, the position and distance between the transmitter and the aircraft should be adjusted in time, and the antenna position should be adjusted to ensure that the aircraft is always within the best communication range.

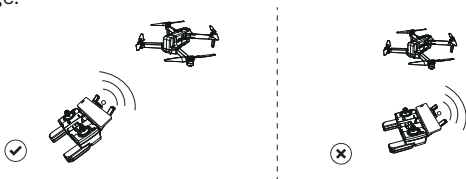

- Install the mobile phone into the transmitter bracket, refer to the aircraft flight direction of the Attitude Indicator in the APP, and the Attitude Indicator points straight ahead (perpendicular to the coordinates), indicating that the transmitter is facing the aircraft.

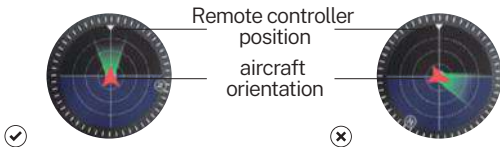

4.4 Linking the Transmitter

Before each aircraft flight, you need to link with the transmitter. After the linking is successful, you can control the flight of the aircraft. The steps for the pairing are as follows:

- Turn on aircraft
- Turn on transmitter
- Flick the left stick of transmitter up and down, and after the aircraft emits a beep, it means the linking is successful.
- Connect your mobile phone to aircraft's WiFi "RUKO-PRO-XXXXXX", tap the APP to enter the control interface; the mobile phone screen displays information such as the transmitter's battery signal and camera screen.

⚠ If the connection is successful, the aircraft light will turn pink.

- Before each flight, check the power of the transmitter. The transmitter will "beep" when the battery is low. The transmitter will automatically shut down after 10 minutes of inactivity. Toggle the joystick or press any button to restore the transmitter to its normal working state.
- When using the transmitter handle to hold a mobile device, be sure to press it firmly to prevent the mobile device from slipping off.
- Keep the battery at around 3.8-3.9V, and recharge it every 1 month or so to keep the battery active.

5 Ruko Pro App

5.1 Home

- After running Ruko Pro App, enter the homepage.



• CONTROLS

Operate the aircraft through the APP page buttons to realize the functions of the aircraft.

• LEARN TO FLY

Click to enter the flight YouTube video website, where you can view the flight guidance of the corresponding product.

• GUIDE

Click to view Help Manual、Instructions Videos and Quick Start. Long press the position of the non-function icon on the APP homepage to enter the flight log interface, and click the file to share and send.



5.2 Camera View



① Aircraft Status Indicator Bar

In flight: Display the flight status of the aircraft and various warning information.

② Transmitter Battery Display

When the mobile phone is not connected to the aircraft's WiFi, this icon is transmitter . After the mobile phone is connected to the aircraft's WiFi, this icon is the transmitter real-time voltage  1.6V.

③ GPS Status

Used to display the GPS signal strength, 3 bars indicate that the GPS signal meets the flight requirements, 1 or 2 bars indicate that the GPS signal is weak, and the flight position needs to be changed.

- ④ **🔋 Intelligent Flight Battery Information Bar**
Display the current intelligent flight battery power and voltage, and the power progress bar displays.
- ⑤ **⋮ System Settings**
System settings include flight range settings, data recording, English and metric unit switching, route display, reminder information and voice prompt settings.
- ⑥ **🗂️ SD Card**
Check the SD card capacity and formatting.
- ⑦ **📷 Shooting Mode**
Choose to take a picture or record a video.
- ⑧ **📸 Shutter / Record Button**
Tap to start shooting photos or recording video.
- ⑨ **▶️ Playback**
Tap to enter playback and preview photos and videos as soon as they are captured.
- ⑩ **🎤 Recording**
Tap this button to trigger the mobile phone end of the APP to start/stop recording.
- ⑪ **Flight Status Parameters**
D N/A: Flying distance
H N/A: Flying height
DS N/A: Flying speed
VS N/A: Ascent/decrease speed
- ⑫ **Attitude Indicator**
Display information of the orientation of the aircraft, and position of the transmitter .

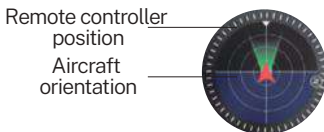

13 More Features

GPS Follow: Tap to start the follow me function, the aircraft will use the GPS in the smartphone to follow you.

Music: Add music to the video. Click to enter the music page, select the page and enter the video shooting.

VR: Click this button to use the VR glasses function.

Zoom: Click the button to use the zoom function, up to 5 times zoom.

Gesture photo: Tap this icon to use gestures to control aircraft to take photos.

Gesture record: Tap this icon to use gestures to control aircraft recording.

Route rules: Click the change icon to enter the map, select a waypoint on the map, and the aircraft will follow the waypoint to fly. Up to 16 waypoints can be set.

Filter: Tap to select a different filter mode to take photos or videos.



14 RTH

Tap to initiate Smart RTH and have the aircraft return to the last recorded Home Point and turn off the motors.

15 Start Motors / Stop Motors/ Take Off

Click to expand the control panel, click "Slide to start the motors" to start the motors, then click "Take Off" to take off the drone; Click "Stop the Motors" to stop the motors after starting the motors.



16 Back

Tap to return to the home screen.

17 Parameter

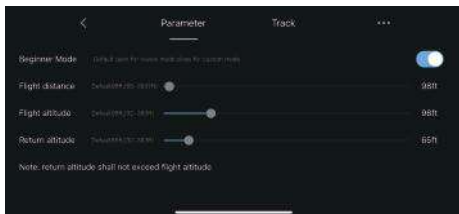

Beginner Mode: In this mode, the aircraft's farthest flight distance and altitude is 98ft, and the return altitude is 65ft, so that the aircraft can fly more safely within sight.

Flying distance: Set the longest distance to fly.

Flight altitude: set the maximum flight altitude.

Return altitude: Set the flight altitude for the aircraft to return in a straight line using the RTH function. When setting the flight altitude, you should consider higher than the obstacles on the return route to avoid collision with the aircraft.

18 Track



Footprint: The total number of aircraft flying areas.

Max mileage: The longest mileage for a single flight.

Max altitude: The highest single flight altitude.

Max speed: The fastest single flight speed.

All flight records: The date, location, distance, duration and

Find drone: Display the location of the drone on the map.

19 ...

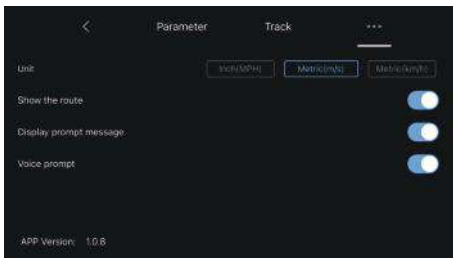

Unit: Switch between metric and imperial measurement units.
Show the route: turn on or off all flight records of map tracks in the track menu.

Display prompt message: Turn on or off the aircraft status prompt message in the APP.

Voice prompt: turn on or off the aircraft status voice prompt of the APP.

-
- ⚠ • Before using the Ruko Pro App, make sure that the phone has sufficient power.
- When you use the Ruko Pro App on your mobile phone, please focus on controlling the aircraft. Do not answer incoming calls, send and receive text messages or use other mobile phone functions during the flight.
 - The map used in the map interface needs to be downloaded from the Internet. **Before using this function, do not connect to the aircraft WiFi, and connect the mobile device to the Internet to cache the map.**
-

6 Flight

After the installation preparation is complete, please conduct flight training or training first. It is recommended to conduct training in the beginner mode. Please choose a suitable flight environment when flying. The flying altitude is limited to 393ft, and the local laws and regulations must be strictly observed during flight. Please be sure to read the F11 PRO Disclaimer and Safety Summary, and understand the safety precautions before flying.

6.1 Flight Environment Requirements

- Do not fly in severe weather such as strong wind, snow, rain, and fog.
- Choose an open place with no obstructions around as the flying field. The compass and GPS signals on the aircraft will be interfered by buildings, mountains, and trees. It is recommended to fly in an open space with a diameter of 32 ft without interference. It is recommended that the flight altitude be greater than 49 ft to avoid ground obstacles and other signal interference from the ground.
- When flying, keep in sight and control, and stay away from obstacles, crowds, etc. When flying on the water surface, please be more than 9 ft above the water surface.
- The transmitter may be interfered by high-voltage lines, communication base stations or transmission towers. Please fly away from these areas.
- Please fly below 6561 ft above sea level to ensure that the air pressure setting function of the aircraft can work normally.
- When GPS is active, the aircraft can achieve stable hovering, intelligent return to home, and intelligent flight functions. When the GPS function fails, these functions cannot be implemented. The aircraft will be unable to hover, drifting away in the direction of the wind.

6.2 Pre-Flight Checklist

- Whether the transmitter, intelligent flight battery, and mobile device are fully charged.
- Make sure that the aircraft arms are fully extended. Make sure that the battery compartment cover is fastened firmly and the intelligent flight battery is installed firmly.
- Ensure that the propeller is free from damage, aging, deformation, no foreign matter entanglement, and secure installation.
- Please make sure that GPS is turned on to avoid that it would be lost, please fly outdoor in an open place.
- Whether the 4 motors can start normally after power-on, and whether the rotation speeds are consistent.
- Connect drone WiFi with your phone, make sure that you have connected the WiFi name RUKO-PRO-XXXXXX "exactly after App access right and Internet permission with your phone.
- Make sure the camera is clean.
- If you need to replace parts, be sure to use original parts. The use of non-original accessories may cause danger to the safe use of the aircraft.
- For details on accessory support, please refer to the accessory support page in the appendix of the user manual.

6.3 Calibration Before Flight

Aircraft needs to carry out a series of calibration work before flying, the main purpose is to avoid the accident that the aircraft loses control and crashes caused by the inaccurate GPS signal during the flight.

• Match the aircraft with the transmitter and mobile phone

① Unfold the four arms of the aircraft and place them on an open level ground with the nose facing forward and the tail facing the pilot.

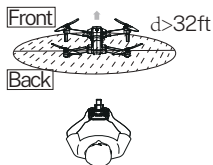

An open space with a diameter of 32 ft and no interferences.

② Long press the power button of aircraft, the motor light will be on and you will hear a beeping sound, indicating that the aircraft has been turned on;

③ Short press the transmitter power button once to turn on the transmitter switch;

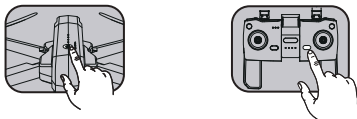

④ Connect the mobile phone to aircraft's WiFi (name: RUKO-PRO-XXXXXX), click on the App to enter the control interface;



⑤ Push up the left stick of the transmitter to 12 o'clock and then pull it down to 6 o'clock to unlock the link. After the aircraft emits a "beep" sound, the aircraft's light programming is pink, which means the linking is successful, and the phone screen displays the Aircraft's calibration compass, transmitter's battery signal and other information.

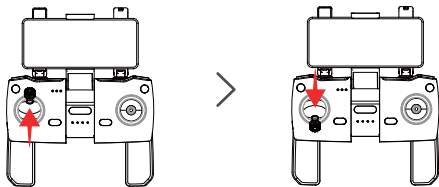

-
- ⚠ • When the Android phone is connected to aircraft's WiFi (named RUKO-PRO-xxxxxx), as the aircraft's WiFi has no network, wait for about 10-40 seconds on the phone WiFi setting page, the phone will pop up the network setting option to ask whether to continue to connect to aircraft's WiFi, please set it to continue to use aircraft's WiFi, so as not to cause the APP to be unable to see the image transmission screen.
- Please turn off the VPN switch of the phone to avoid the APP not being able to see the image transmission screen.
 - If the mobile phone is set to priority on Internet speed and the APP cannot see the image transmission screen, please set the mobile phone to airplane mode and try.
 - Aircraft image transmission WiFi is 5.8G, mobile phone WLAN function must be supported; dual-band WiFi, 2.4G+5.8G, can be applied.
-

• Match the aircraft with the transmitter and mobile phone

① Push the left rocker of transmitter to the "1 o'clock" position and the right rocker to the "11 o'clock" position, the light of the arm flashes quickly, the light of the front arm is white and the light of the rear arm is white pink;



When the drone is turned on, it will automatically enter the calibration process. You only need to perform this step when you need to recalibrate.

② At this time, you need to follow the prompts to pick up the aircraft at a distance of 1m from the ground and rotate the aircraft horizontally for 1-2 laps until the APP interface prompts to enter the vertical calibration.

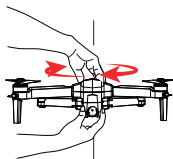

③ Pick up the aircraft at a distance of 1m from the ground, and rotate the aircraft 1-2 laps vertically with the camera facing upwards until the prompt of vertical calibration on the APP interface disappears. After the compass calibration is completed, place the aircraft on a level ground. At this time, the front arm of the aircraft has a white light and the rear arm has a blue light, and the App prompts that the compass calibration is complete.

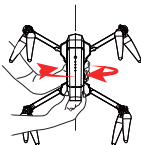

- ⚠ • The aircraft must be calibrated with the compass every time it is turned on before it can take off. After the aircraft is turned on and the frequency is turned on, the aircraft can be calibrated in steps ②. and ③.
- When the aircraft is flying in a circle or out of control in a complex environment, the aircraft compass calibration is not standard or interfered. Please land the aircraft manually in time to manually calibrate the aircraft (refer to the first step of calibrating the compass).
- When calibrating the aircraft, please open the arm to avoid the influence of the magnetic field of the motor.

• Calibrate the gyroscope / level

- ① Make sure that the aircraft is placed on a level ground and there is enough space under the camera.
- ② Push the left and right joysticks to the "11 o'clock" and "1 o'clock" positions respectively.

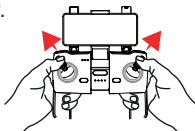

- ③ The front white and back blue lights flash quickly, the camera rotates up and down again for self-checking, and the App displays horizontal calibration.

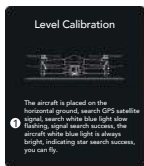

- ④ The APP prompts that the level calibration is successful, the front light becomes steady white, and the rear light becomes steady blue; indicating that the calibration is complete.
- ⑤ After the calibration is completed, "Fly" is displayed in the APP, and you can now prepare to take off.

-
- ⚠ • When the aircraft's flight state is tilted and unstable, please land the aircraft on a level ground for gyroscope/horizontal calibration.
 - When the aircraft resets the gyroscope/horizontal calibration, the camera will also swing up and down again for self-checking to ensure that there is enough space at the bottom of the camera.
-

6.4 Starting/Stopping the Motors

• Starting the Motors

Push the joysticks into 5 & 7'o clock positions to start the motor.

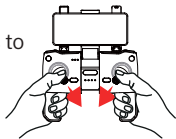

• Stopping the Motors

After the motor starts rotating, there are two ways to stop:

Method 1: After the aircraft takes off, push the throttle stick to the lowest positions and operate the aircraft to land until the motor stops, then release the joystick.

Method 2: When the flight is not taking off, Push the joysticks into 5 & 7'o clock positions to start the motor. After the motor is turned off, please release the joystick immediately.

• Manually Land the Aircraft

When you need to manually land the aircraft, continue to push the transmitter throttle lever downwards. Do not release the throttle lever during landing until the aircraft lands and the motors stop.

-
- ⚠ • Please choose a flat ground to land.
-

6.5 Automatic Take-off / Automatic Landing

• Automatic take-off

After the aircraft is calibrated, users can use the automatic take-off function:

- ① After the calibration is completed, "Fly" is displayed in the APP, and you can now prepare to take off. Start the motor after confirming the safe take-off conditions.
- ② Click the One-key Takeoff button on transmitter or enter the APP and click OK to take off.
- ③ The aircraft will take off automatically and hover at a distance of 4 ft from the ground.

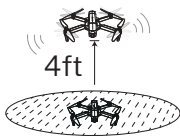
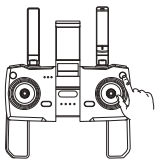

-
- ⚠ • It is recommended to fly in an open space with a diameter of 10 meters without interference;
- The flying height must be higher than ground obstacles to avoid collision;
 - It is recommended that the flight altitude be greater than 15 meters to avoid other signals interference from the ground.
-

• Automatic landing

After the aircraft takes off, users can choose to use the automatic landing function:

- ① Confirm the safe landing conditions, click the One-key Take off button on transmitter or enter the APP, click, and long press the button to confirm to enter the automatic landing.
- ② When the aircraft is descending, push the throttle lever of the transmitter up and immediately open it to exit the automatic landing process.
- ③ The aircraft landed on the ground and turned off the motors by itself.

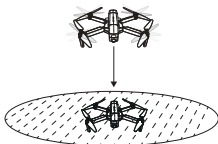
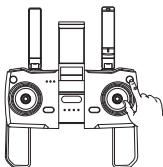

6.6 How to take off the Ruko F11 PRO Drone

• Basic Flight Steps

- ① Place the aircraft on a flat and open ground with the nose facing forward and the tail facing the pilot.
- ② Power on the aircraft.
- ③ Turn on the power of transmitter, push the left joystick up to 12 o'clock and pull it down to 6 o'clock to unlock and pair with aircraft.
- ④ Connect the mobile phone to Aircraft's WiFi RUKO-PRO-XXXXXX, open the Ruko Pro APP, and enter the camera interface.

- ⑤ After the aircraft calibration is completed, the status indicator is always white before and blue, and the motor is started.
- ⑥ Slowly push the throttle stick upward to let the aircraft take off smoothly.
- ⑦ Pull down the throttle stick to lower the aircraft.
- ⑧ After landing, pull the throttle stick to the lowest position and hold it until the motor stops.
- ⑨ Turn off the power of aircraft and transmitter in turn after shutdown.

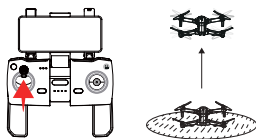

 • For more detailed instructions, please refer to chapter 6.1 ~ 6.4

6.7 Aerial Photography Tips & Tricks

- Perform pre-flight inspection.
- It is recommended to take photos or videos in low-speed or medium-speed gear.
- Choose sunny and less windy weather for shooting.
- Push the stick as little as possible during the flight to make the aircraft fly smoothly.

 • Awareness of flight safety is very important for the safety of you, the surrounding people and the environment. Please read the "Safety and Disclaimer Guidelines" carefully.

7 Appendix

7.1 Specifications

- **Parameter**

Model: F11 PRO Weight (including battery): 520g/18.3oz
Flight time: About 30 minutes (under a constant-speed flight in a no-wind environment)
WiFi distance: 500m-800m (outdoor, unobstructed, independent)
Motor model: 1806
Recovery: Enabled
Operating temperature range: 32 degrees Celsius to 104 degrees Celsius (0 degrees Celsius to 40 degrees Celsius)
Satellite system: GPS/glonas
Size: Unfold 445mmX405mmX80mm;
Folded: 176mmX105mmX80mm

- **Intelligent Flight Battery**

Capacity: 2500mAh
The maximum charging time is about 5 hours (depending on the charging power)
Voltage 11.1V
Battery type: Lipo
Charging temperature range* to 164°F (-10* to 40°C)
Energy: 27.75Wh
Net weight: 195g/6.8oz
Maximum charging power: 15W

- **Camera**

Lens: FOV120°
Still photography mode: Single lens
Video recording mode: UHD
Photo: JPG
Video: MP4
Supported SD card: up to 32GB (not included)
Operating temperature: 32° to 104°F (0 to 40° C)

- **APP/Live View**

Mobile application: RUKO PRO

Real-time view working frequency: 5GHzISM

Real-time quality: (depending on product configuration)

Compatible mobile phones: Support dual-band WIFI (2.4GHz and 5GHz)

Latency: Low-latency video (depending on the conditions and required actions of the mobile device)

Mobile phone system required: Android 6.0 or higher, iOS 10.0.2 or higher

Configuration		Storage method		Resolution	Nitroso formate
F11 PRO	4K	Mobile	Photo	3840X2160P	
			Video	1280X720P	25fps
		TF card	Photo	3840X2160P	
			Video	2976X1680P	

- **Transmitter**

Working frequency: 2.4GHz

Capacity: 300mAh(depending on product configuration)

Working voltage: 3.7V

Maximum transmission distance: 1614 feet (outdoor interference-free environment)

Maximum charging time: 50 minutes (depending on the charging power)

Transmitter Time: About 10 hours

Mobile device bracket: 4.7 inches to 6.5* smart phone (mobile phone diagonal) Length) / 2 feet to 3 inches smartphone (mobile phone width)

Working temperature: 32 degrees Celsius to 104 degrees Celsius

- **USB Cable**

Rated power: ≤15W

7.2 Accessories Support



Battery



Propeller



Arm



Landing Gear



Camera



transmitter

All of the above accessories can be searched and purchased on Amazon, and you can enter the Ruko store to buy them yourself. Be sure to use original accessories. The use of non-original accessories may cause danger to the safe use of the aircraft.

CONTACT US FOR MORE TECH SUPPORT

Printed in China.



7.3 Common Problems and Solutions

Question	Reason	Solutions
The motors cannot be started	Weak GPS signal	Turn on the aircraft in an open area with strong GPS signal
	The red light stays on	The aircraft has low battery. Please charge the battery in time
	The pink light stays on	The compass is not calibrated. Please refer to the "Calibration Before Flight" section of the user manual
	The left and right joystick are not in place	Push the left and right joysticks simultaneously to 5 o'clock and 7 o'clock for 2 seconds
Unstable flight	Flying too low, affected by aircraft airflow	Please fly the aircraft above 9.84ft(3 meters)
	The gyroscope is not calibrated	Place the aircraft on a horizontal surface and conduct gyroscope/horizontal calibration. Please refer to the "Calibration Before Flight" section of the user manual
	The propellers become deformed and incomplete	Replace the propellers with new ones
	GPS signal is unstable. Flying near buildings and in obstructed places	Please fly the aircraft in an open area free of obstacles within the circle of radius 32.81 ft(10 meters)

Question	Reason	Solutions
Out of control, spinning around on its own, abnormal sound	The transmitter signal is interfered or the aircraft exceeds the range of remote control	Please fly the aircraft outdoors without interference, and ensure that it is within a controllable range
	Compass interference	Please manually land the drone in time and calibrate the compass. Please make sure to fly away from the buildings, trees, power lines, and signal towers
	The propellers become deformed and incomplete	Replace the propellers with new ones
The camera is tilted/Gimbal is not working/ Can't adjust the camera angle	The drone was placed on an unlevel surface such as grass and sand and so on	Place the drone on landing pad or cardboard horizontally, and ensure a gap between the camera and the surface
	The drone was placed on the surface which transfer small vibration, such as hollow wooden floor, desk and so on	Place the drone on a solid level ground
	Keep touching the camera and gimbal or holding the drone before all set	Never touch the camera when the power is on, place the drone on a level ground until the gimbal complete self-check
	The compass is in calibrating	After complete the compass calibration, place the drone on a level ground

Question	Reason	Solutions
Video freezes, image transmission distance is short	The aircraft is out of Wi-Fi range	Fly the aircraft within the range of the Wi-Fi
	WiFi image transmission signal interference	Fly the aircraft in an unobstructed open area free of buildings, high-voltage wires and signal towers
	The transmitter and the mobile phone are not pointed at the direction of the drone	Point the transmitter and the mobile device at the flying direction of the aircraft to maintain the strongest signal connection
	Phone performance freezes	Close unused apps running in the background to maintain the best performance of the phone
Video is not clear	if use APP storage, the pixels are 1920×720P	Insert the memory card and store the video on the memory card
App does not show what the drone's camera is taking	The phone is not connected to the drone's Wi-Fi	Connect the drone's Wi-Fi : Ruko-PRO-***** on the phone
	The phone operating system version is too low	The required device operating system to work with the app is Android 6.0 and above, IOS 10.02 and above
	Certain phones' setting preventing the app working normally	Set the phone to airplane mode
	The VPN app block the connection of the phone and the drone	Turn off the VPN
	Didn't keep the drone's network when trying to connect the drone's WiFi	Please do keep the drone's WiFi connected when the phone pop up reminder that "This network has no internet access"

Question	Reason	Solutions
APP crashes or functions abnormally	Wrong app downloaded	Download the correct App
	A few mobile phone versions are old and incompatible with APP	Provide mobile phone version and model, we will adapt and solve it
Phone cannot connect to the drone's Wi-Fi	It will take longer time for certain phone to connect with the drone's Wi-Fi for the first time	Try several times or restart the phone
The drone's WiFi name is not displayed in the list	WiFi has not been activated	The WiFi will be available when the drone and the transmitter connected, which take around 40 seconds
GPS signal is weak	Turning on the drone indoors	GPS signals cannot be found indoors. Please search for GPS signals in an open place outdoors
	Under the tree, next to the building, in an obstructed place	Please stay away from obstacles for more than 32.81 feet(10 meters), and search for GPS signals in an open area
Unable to return home, drifting and flying away	GPS signal was turned off during the flight	Please don't turn off GPS suddenly during outdoor flight. Switch back to GPS mode in time
Cannot charge battery/Cannot fully charge battery	Using inferior charger or charging on the computer with unstable voltage output	Use a mobile USB charger that ensures constant stable voltage output(5V) and amperage output(2-3A)
	Using inferior charging cables	Please use the original factory charging cable to charge

Question	Reason	Solutions
Short battery life	Flying in windy weather	Flying in windy weather will accelerate power loss
	Flying in cold weather	In low temperatures, the chemical reaction of the lithium battery is slowed down and the energy cannot be fully released
	The battery is not fully charged	Fully charged with the correct USB charger before flying
The product has slight marks	We tested all aircraft before shipping	In order to give you the best experience, we tested functions of all aircraft before shipping. Therefore, it is inevitable that there will be slight traces. However, it can be guaranteed that all aircraft are 100% brand new

Ruko Tech Support
<https://rukotoy.com/support-drones>

This User Manual is subject to change without notice.

**You can check the recently updated version of "User Manual"
on Ruko's official website**
<https://rukotoy.com/support-drones>

If you have any questions or suggestions about the User Manual,
please contact us via the following email:
rukodrone@gmail.com

Ruko is a trademark of Shenzhen Ruike Innovation Technology Co.,Ltd
Copyright 2023 Ruko All Rights Reserved.

Ruko[®]

rukotoy.com

CONTACT US FOR MORE TECH SUPPORT

 +1 (888)892-0155 | Mon-Fri 7:00AM - 7:00PM (PST)

 +86 19129317359  rukodrone@gmail.com

