

Ruko[®]

14+
for age

User Manual

v3.0

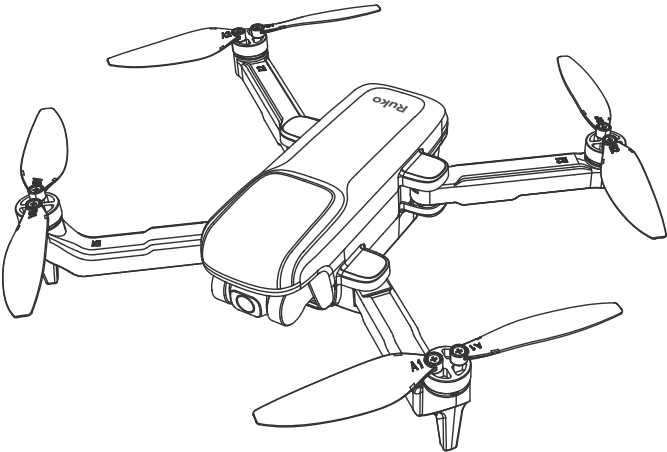

U11 PRO

Contents

1 Using This Manual	3
1.1 Legend	3
1.2 Read Before the First Flight	3
1.3 Download the Ruko GPS App	3
2 Package Contents	4
3 Drone Presentation	5
3.1 Important	5
3.2 U11 Pro Drone Diagram	5
3.3 Camera	6
3.4 Intelligent Flight Battery	8
3.5 Drone Status Indicator	9
3.6 How to Replace the Propeller	10
3.7 How to Replace the Arm	11
4 Remote Controller Presentation	12
4.1 Remote Controller Diagram	12
4.2 Using the Remote Controller	12
4.3 Controlling the Drone Default Setting	14
5 Ruko GPS App Presentation	15
5.1 App Introduction	15
5.2 Return to Home	17
5.3 Point of Interest	18
5.4 Follow Me Mode	19
5.5 Waypoint	19

5.6 Filters	20
5.7 Take off/Landing	21
5.8 How to Find the Lost Drone	21
5.9 Flight Record	22
5.10 Flight Setting and Beginner Mode	22
6 Flight	23
6.1 Flight Environment Requirements	23
6.2 Pre-Flight Checklist	23
6.3 How to Fly in Outdoor Environment	24
6.4 How to Fly in Indoors	28
7 Warning	28
8 Specifications	30

1 Using This Manual

1.1 Legend

- The following terms are used throughout the product literature to indicate various levels of potential harm when operating this product :



Recommend



Warning



Hints & Tips



Reference

1.2 Read Before the First Flight

- Read the following documents before using Ruko U11 Pro :
 - User Manual
 - Quick Start Guide
 - Disclaimer and Safety Guidelines
- It is recommended to watch all tutorial videos on the official Ruko website and read the disclaimer and safety guidelines before using them for the first time. Prepare for your first flight by reviewing the quick start guide and refer to this user manual for more information.

1.3 Download the Ruko GPS App

- Make sure to use the Ruko GPS app during flight. Scan the QR code on the right to download the APP.



Download on the
App Store



ANDROID
APPS



Flight Guidance
Video

- iOS System : The iOS version of Ruko GPS is compatible with iOS v9.0 and later.
 - Android System : The Android version of Ruko GPS is compatible with Android v5.0 and later.
 - For the first flight, please check the flight guidance video.



- The operating temperature of this product is 0°F to 104° F.
 - It does not meet the standard operating temperature for military-grade application (-67°F to 257° F), which is required to endure greater environmental variability.
 - Operate the product appropriately and only for applications that meet the operating temperature range requirements of that grade.

2 Package Contents



Drone (no battery)



Transmitter



Drone Battery



Phone Holder



Propeller A
Propeller B



USB Charging Cable



Screwdriver



Screw



User Manual



Disclaimer and Safety Guidelines



Quick Start Guide

* The content of the package is subject to the actual product

3 Drone Presentation

- Thank you for purchasing from Ruko. Please read all instructions and warnings carefully before operating. Please also keep this instruction manual for future reference and maintenance.

3.1 Important

- The U11 Pro Drone is NOT a toy and is not suitable for people under the age of 14. It requires correct assembly and debugging to avoid any accident before every flight. Inappropriate use of the product could result in personal injury or property damages.
- In the event of a problem during use, operating, or maintenance, please feel free to contact our after sale service team.

3.2 U11 Pro Drone Diagram

- This drone is equipped with Optical Flow Positioning and GPS Positioning systems. It can fly indoors and outdoors and has functions such as Return To Home, Route Planning, Follow Me, and Point of Interest.

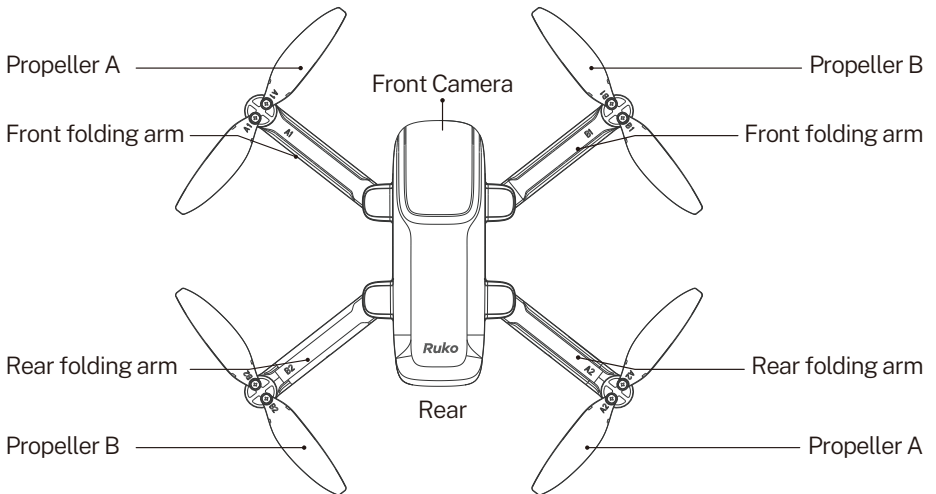

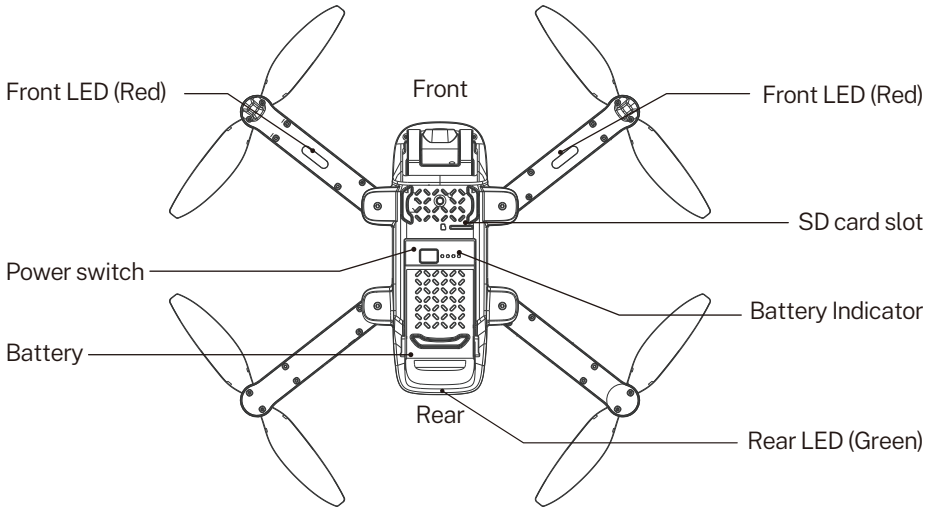

3.3 Camera

• Camera Profile

Ruko U11 Pro drone is equipped with a 120° wide-angle camera, and the tilt angle is adjustable from -90° to 0°.



Refer to the page 13 to know how to adjust the angle of the camera.

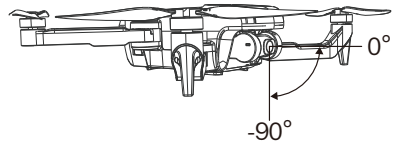

• Storing Photos and Videos

Take photos or record videos without an SD card inserted. The file will be directly stored on the mobile device.

Insert the SD card, and the video pixels stored in the SD card are better.

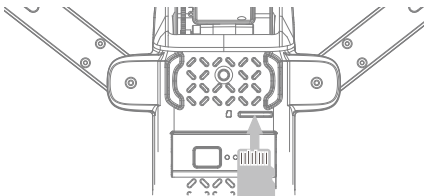

SD card is not included



Storage Mode	Photo Resolution	Video Resolution
Mobile Phone	3840x2160P	1280x720P
SD Card	2048x1152P	2048x1152P

- Take photos or record videos without an SD card inserted. The file will be directly stored on the mobile device.
- Insert the SD card, and the video pixels stored in the SD card are better.



- Do NOT remove the SD card from the drone while it is powered on. Otherwise, the SD card may be damaged.
- Before shooting important photos or videos, shoot a few images to test the camera is operating correctly.
- Make sure to power off the drone correctly. Otherwise, the camera parameters will not be saved and any recorded videos may be damaged. Ruko is not responsible for any failure of an image or video to be recorded or having been recorded in a way that is not machine readable.
- Click the SD card icon  to format the SD card and select FAT32 as the file system at the same time.
- The capacity of SD card must be 32GB or smaller.

3.4 Intelligent Flight Battery

- The Ruko U11 Pro Intelligent Flight Battery is a 7.6 V, 1900 mAh battery with smart charging and discharging functionality. Refer to the Ruko U11 Pro Disclaimer & Safety Guidelines on the battery before use.

• Battery Diagram

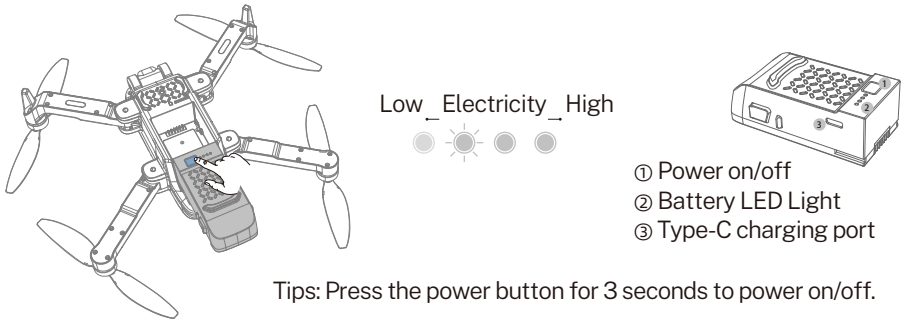

• Installing/Removing the Battery



- ✓ • Make sure that the battery is mounted firmly before flying.
- DO NOT detach the battery when the drone is powering on.

- ⚠ • Installing: Install the Intelligent Flight Battery in the drone before use. Insert the battery in the battery compartment and secure the battery clamp. A clicking sound indicates the battery is fully engaged. Make sure that the battery is fully inserted and the battery cover is secure in place.
 - Removing: Press the battery clamp and detach the battery from the battery compartment to remove it.

• Precautions for Charging

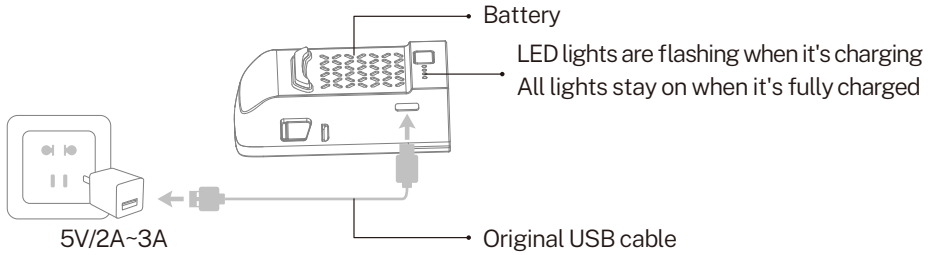

Refer to the Ruko U11 Pro Disclaimer & Safety Guidelines before use.
Users take full responsibility for all usage and operations.

3.5 Drone Status Indicator

- Refer to the following table to understand the status of the different indicators.

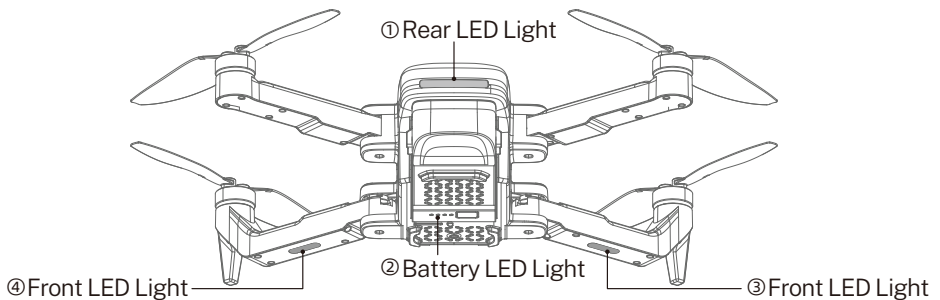

Indicator status	Meaning
The Front LED light (Red) is flashing slowly, Rear Led light (Green) stays on and then goes off	The power of the drone is turned on
The Rear LED light (Green) is flashing slowly, Front LED lights (Red) stay on	Horizontal calibration is completed
All LED lights are flashing alternately	Vertical calibration is completed
First, all LED lights are flashing quickly, then all LED lights are flashing alternately	Gyroscope calibration is completed
All LED lights stay on during outdoor	The searching GPS signal is successful

3.6 How To Replace the Propeller



- ① Make sure the mark of the new propeller must be matched with the arm.
- ② Loose the screws of motors.
- ③ Take out the damaged propeller.
- ④ Replace damaged blades with new ones.
- ⑤ Install propeller securely and tighten screws.
- ⑥ Complete.

- ⚠ • Install carefully. Failure to comply with instructions could result in personal injury and property damage.
- Make sure the propeller is properly installed, or the drone might not work normally.
 - Only use the propeller accessories provided by RUKO, or it may damage to the drone.

3.7 How To Replace the Arm



- ① Make sure the new arm is the correct one for replacement.
- ② Loosen the screws of the arm.
- ③ Remove the drone cover.
- ④ Melt the connected wire(s) using a welding tool and remove it, and then replace the damaged arm with new ones.
- ⑤ Re-connects the wire(s) and weld firmly with the welding tool.
- ⑥ Securely tightened screws.

4 Remote Controller Presentation

4.1 Remote Controller Diagram

- Ruko U11 Pro comes equipped with a remote controller. The built-in battery of the controller has a capacity of 3.7V 1200 mAh.

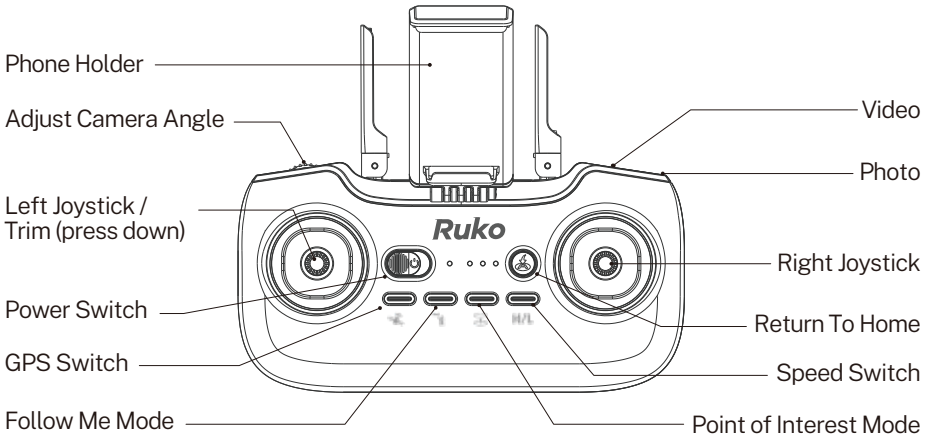

4.2 Using the Remote Controller

• Powering On/Off

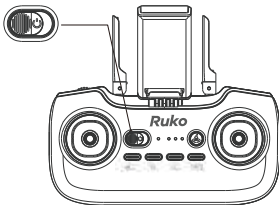

- ① Powering On/Off
- ② The remote controller should be fully recharged before use in the first time.
- ③ Know the current battery level through APP while flying. If the battery level is too low, please stop flying.

• Charging the Battery

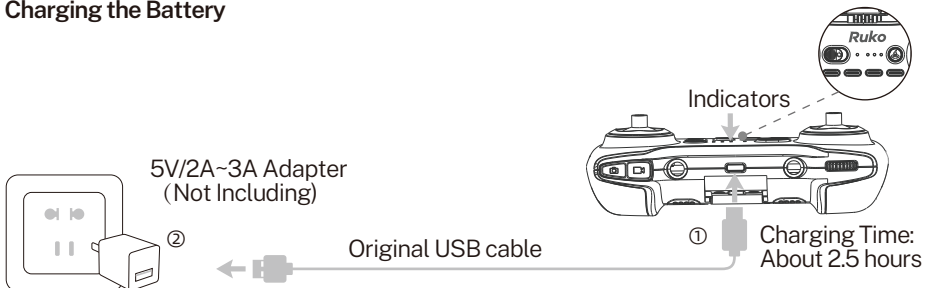

- ① The remote controller can't work while charging, please fully charged before use.
- ② Refer to Disclaimer & Safety Guidelines to get more information about precautions for charging and daily maintenance of the battery.

• Controlling the Camera

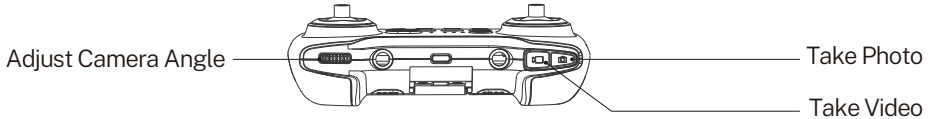

- ① Adjust Camera Angle: Use to adjust the angle of the camera.

• GPS Button

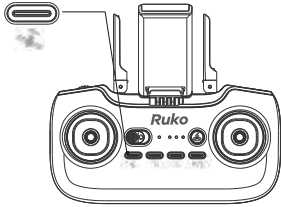

- ① GPS mode is turned on by default.
- ② Long Press to turn off GPS mode, blue LED lights of remote control goes off.
- ③ GPS mode must be turned off when flying indoors.

• Speed Switch Button

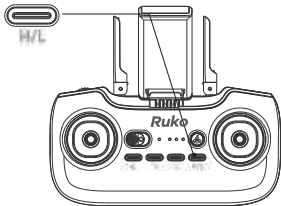

- ① Default Medium Speed Mode.
- ② Press this button once to enter High-Speed Mode.
- ③ Press this button twice to enter Low-Speed Mode.

- Tips: Flying indoors is slower than outdoors.

4.3 Controlling the Drone Default Setting

Left Joystick

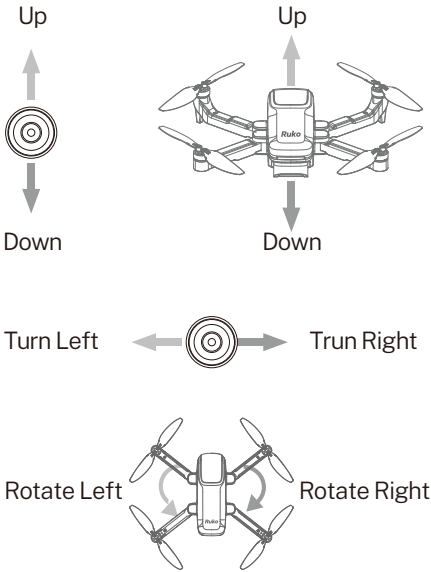

Right Joystick

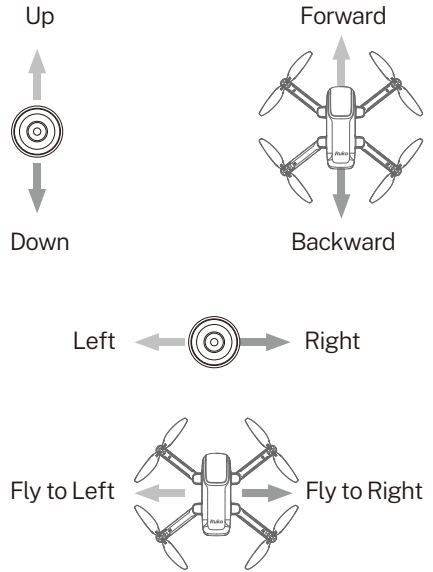

5 APP Presentation

5.1 App Introduction

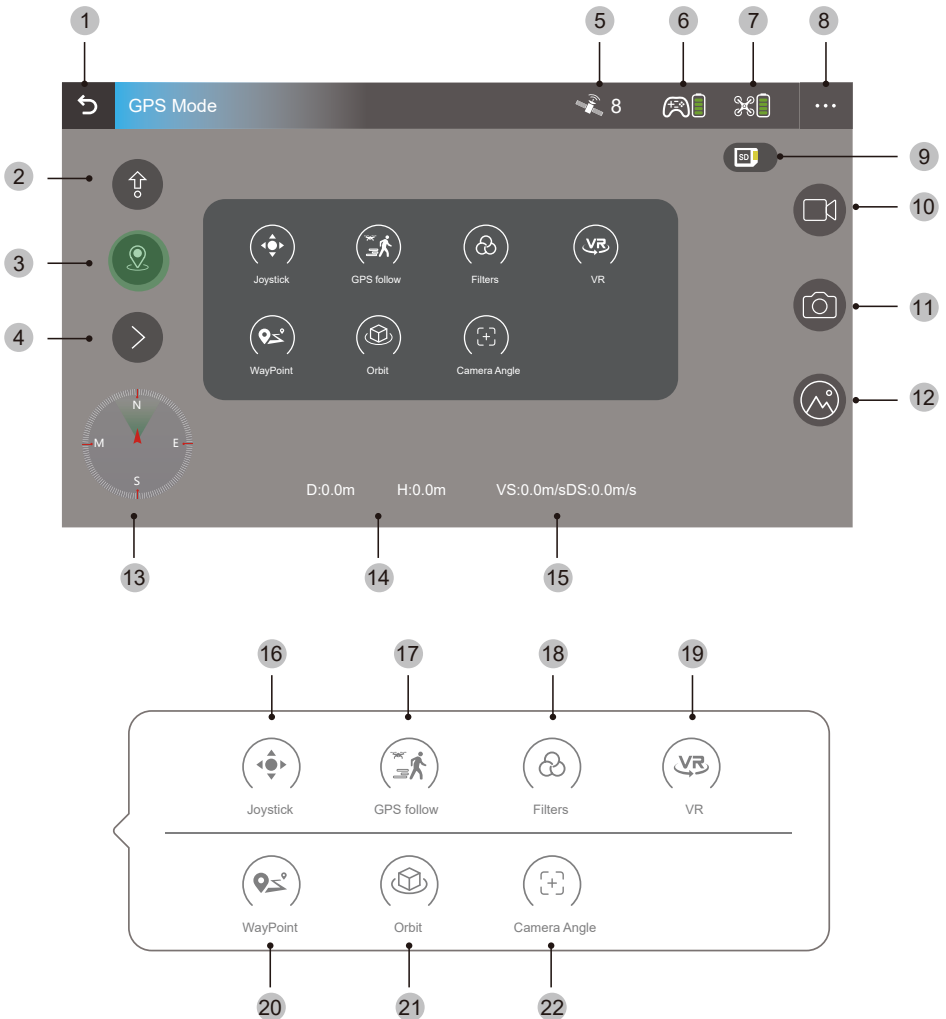

① Back: Tap to return to the home screen.

② One Key Take Off/Landing: Tap the icon to initiate auto take off or landing.

③ RTH: Tap the icon to initiate Smart RTH and have the aircraft return to the Take off Point.

④ More Functions: Tap the icon to display the menu for more functions.

⑤ GPS Status: Displays the current GPS signal strength.

- ⑥ Controller Battery Information: Displays the current battery level of the remote controller.
- ⑦ Drone Battery Information: Displays the current battery level of the drone.
- ⑧ System Settings: Tap to view information about Beginner Mode, Flight logs, Calibrate, and other settings.
- ⑨ SD Card Information: Display the SD card (not included), tap to format the SD card.
- ⑩ Shutter Button: Tap to take a photo.
- ⑪ Record Button: Tap to start or stop recording a video.
- ⑫ Gallery: Tap this button to preview photos and videos.
- ⑬ Attitude Indicator: Displays information such as the orientation and tilt angle of the aircraft.
- ⑭ Flight Telemetry: Displays the distance between the aircraft and the Take-off Point, height from the Take-off Point.
- ⑮ Flight Speed: Displays the aircraft's horizontal and vertical speed.
- ⑯ Joystick: Tap it to enter joystick control. It has the functions same as the joysticks of remote control.
- ⑰ GPS Follow: Tap this button to initiate Follow Me function, and tap it again to cancel Follow Me function.
- ⑱ Filters: Tap this button to initiate the Filters function. There are 6 special photo effects selected.
- ⑲ VR: Tap this button to initiate the VR function.
- ⑳ WayPoint: Tap this button to initiate the Route Planning function, up to 21 flight points can be set.
- ㉑ Point of Interest: Tap this button to initiate Point of Interest function. The aircraft circles around the subject.
- ㉒ Camera Angle: Tap this button to adjust the camera angle.





- Make sure to fully charge your mobile device before launching RUKO GPS.
- Familiarize yourself with the related regulations in your area. You are solely responsible for being aware of all relevant regulations and flying in a way that is compliant.
- DO NOT accept phone calls or use texting features during the flight if you are using a mobile phone as your display device.
- The app is designed to assist your operation. Use eyes and sound discretion and DO NOT rely on the app to control the aircraft.

5.2 Return to Home

- The aircraft automatically flies back to the Take-off Point when Smart RTH is initiated, the aircraft enters Low Battery RTH or Failsafe RTH the during the flight.
- ✘ • Ruko U11 Pro drone doesn't have obstacle avoidance.
 - DO NOT turn off the remote control while flying.

• Smart RTH



- If the GPS signal is sufficient, Smart RTH can be used to bring the aircraft back to the Take off Point.
 - Smart RTH  is initiated either by tapping in RUKO GPS APP or by pressing the RTH button on the remote controller.
 - Exit Smart RTH by tapping in RUKO GPS or by pressing the RTH button on the remote controller.
 - The default RTH altitude is 20m (65.6 ft) . Tap the  button to enter to close beginner mode, then set the return altitude as you want.
 - If the altitude of the drone is less than 20m (65.6 ft) , it ascends to the 20m (65.6 ft) RTH altitude and then flies back to the Take-off Point.
- ### • Low Battery RTH

Low Battery RTH is triggered when the Intelligent Flight Battery is depleted to the point that the safe return of the aircraft may be affected.

 The aircraft will automatically return to the Take-off Point when the battery level is low. There is two modes in low battery RTH.

- When in low battery, it will return to the 30m (98 ft) RTH altitudes above the Take-off Point, the user can cancel RTH by pressing the RTH button on the APP or press RTH button on the remote controller, you can cancel RTH and fly it within a radius of 30m (98 ft) from Take off Point.
- When in super low battery, it will return to the 30m (98 ft) RTH altitudes above the Take off Point, then landing, the user can't cancel RTH but can control the direction to avoid obstacles while landing.



• **Failsafe RTH**

If the GPS mode was successfully open, Failsafe RTH automatically activates after the remote controller signal is lost for more than 5 seconds, it will automatically cancel the Failsafe RTH when the remote controller receives the signal from the drone, you can continue operating it.

5.3 Point of Interest 

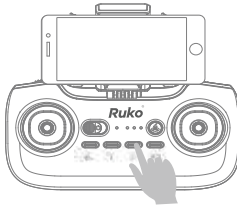
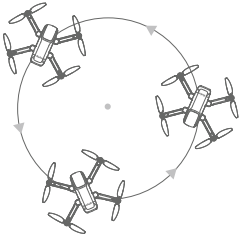
- The aircraft tracks the static subject in a circle based on the radius and flight speed that is set, such as building, lighthouse, etc.



 • Point of Interest  is initiated either by tapping in RUKO GPS APP or by pressing the Point of Interest button on the remote controller. And the remote controller sounds beeps to start the Point of Interest Mode.

- The White LED Light(No.4 Light) of remote control stays on while in Point of Interest Mode. Exit Point of Interest by tapping in RUKO GPS or by pressing the Point of Interest button on the remote controller.

- How to adjust the circle radius and flight speed?

① You can push the Right Joystick up or down to adjust the the circle radius.

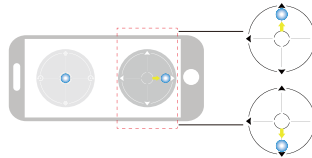

② You can push the Right Joystick to left or right to adjust the speed or direction notice the speed and direction on APP.

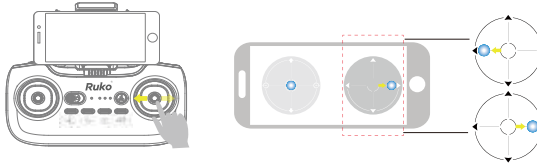

5.4 Follow Me

- In the outdoor GPS mode, the drone can locate the mobile phone signal source by GPS and move with the location of the mobile phone.

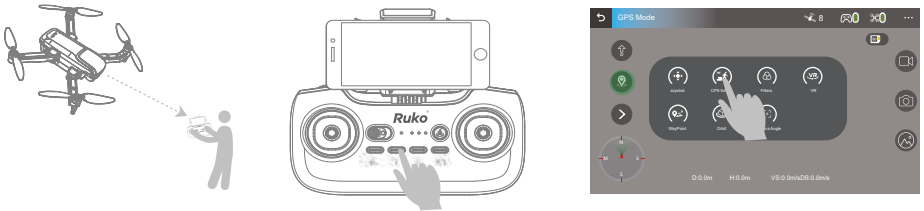





⚠ • How to use the Follow Me function?

- Follow Me  is initiated either by tapping in RUKO GPS APP or by pressing the Follow Me button on the remote controller, at that time the remote controller sound beeps.
- The White LED Light(No.3 Light) of remote control stays on while in Follow Me mode.
- Exit Follow Me by tapping in RUKO GPS or by pressing the Follow Me remote controller.

5.5 Waypoint

- The aircraft automatically fly according to the customized waypoints, up to 21 waypoints can be set. The aircraft will fly in order from the first waypoint to the last one.





- ⚠️ • How to use the Waypoint function?
 - ① Tap  to enter the Waypoint function.
 - ② Tap  to select the waypoints on the map that you want, here are two ways to select Waypoints, it can choose the Waypoints one by one, it also can select the Waypoints by line.
 - ③ Tap  to delete the waypoints that you don't want.
 - ④ Tap  to save this waypoint, then the drone will fly according to these waypoints selected.



5.6 Filers

- Ruko U11 Pro has 6 photos filters effects that can be selected while taking a photo or videos.



- ⚠️ • How to use the Filters function?
 - ① Tap  to enter the Filter function in RUKO GPS APP.
 - ② Choose one filter you want.
 - ③ Tap  to initiate the Filter function, start taking photos or recording videos.

5.7 Take off/Landing

- Click  icon to take off, the drone will fly up automatically and keep flying at an altitude of approximately 3.9ft.
- Click  icon to land, and the drone will land automatically.

5.8 How to Find the Lost Drone

- If the drone fails to return due to unexpected reasons during the flight, the Find Drone function helps to find the location of the aircraft.

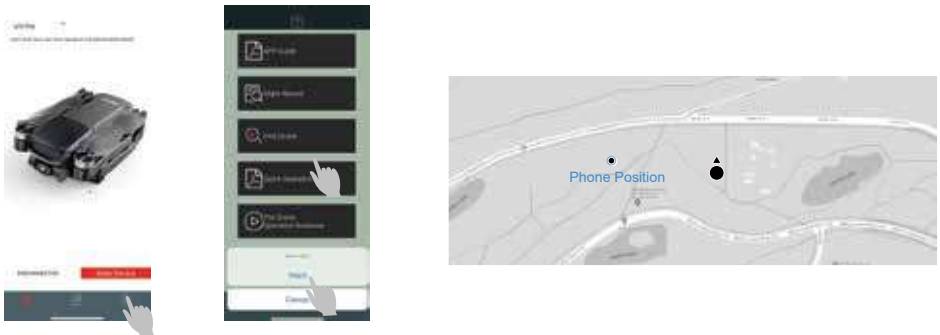



• How to use Find Drone function?

- ① Open RUKO GPS APP, tap  to initiate the RUKO GPS function;
- ② Select Maps, then open it.
- ③ Go to find the drone according to the location on the map.

-  The location on the map is the last recorded Flight Point, so there may be errors in the actual position, depends on the environment.
- This function can't work without GPS Mode.

5.9 Flight Record



- Open RUKO GPS APP, tap  to enter Flight Record  function.
- Tap  to download the record.

5.10 Flight Setting and Beginner Mode

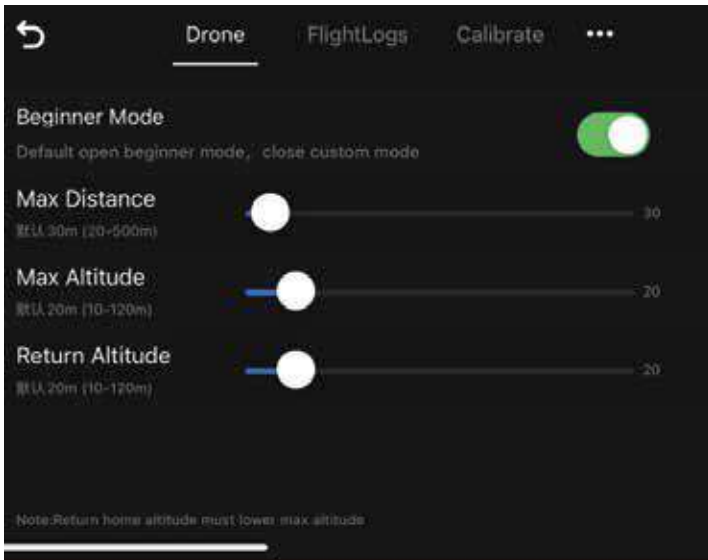

-  The Default GPS Mode is Beginner Mode:
 - ① Flight Distance is between 0 and 30 m (98.4ft).
 - ② Flight Altitude is between 0 and 30 m (98.4ft).
 - ③ RTH Altitude is under 20 m (65.6ft).
- You can turn off the Beginner Mode to set the parameters in the App.

6 Flight

- Once pre-flight preparation is complete, it is recommended to hone your flight skills and practice flying safely.
- Recommended to fly the first time in an open outdoor area, instead of indoors, as you will have more space to safely operate while learning.
- Make sure that all flights are carried out in an open area (Without obstruction within a radius of 35 ft) .
- Refer to the Remote Controller and APP sections for information about using the remote controller and the app to control the aircraft.

6.1 Flight Environment Requirements

- Do NOT use the aircraft in severe weather conditions including snow, rain, and fog.
- Only fly in open areas. Tall structures and large metal structures may affect the accuracy of the onboard compass system. It is recommended to keep the aircraft at least 65 ft away from structures.
- Avoid obstacles, crowds, high voltage power lines, trees, and bodies of water.
- Minimize interference by avoiding areas with high levels of electromagnetism such as locations near power lines, base stations, electrical substations, and broadcasting towers.
- Aircraft and battery performance are subject to environmental factors such as air density and temperature. Be careful when flying at high sea levels, since battery and aircraft performance may be reduced.
- Refer to the Disclaimer & Safety Guidelines for more information about Flight Environment Requirements.

6.2 Pre-Flight Checklist

- Make sure the remote controller, mobile device, and Intelligent Flight Battery are fully charged.
- Make sure the Intelligent Flight Battery and the propellers are mounted securely.
- Make sure the aircraft arms are unfolded.
- Make sure the camera is functioning normally.
- Make sure that there is nothing obstructing the motors and that they are functioning normally.
- Make sure that Wi-Fi and RUKO GPS are successfully connected to the aircraft.
- Make sure that the camera lens is clean.
- Refer to the Disclaimer & Safety Guidelines for more information about the Pre-Flight Checklist.

6.3 How to Fly in Outdoor Environment

• **Step 1: Unfold the Drone Wings and Power on the Drone**

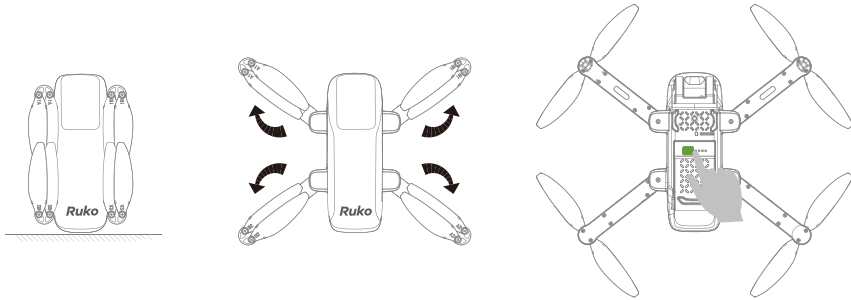

- ⚠ • Unfold wings and put the drone on the horizontal ground.
- Long press the power button for 3 seconds to turn on the drone. All the LED Lights of the drone will stay on, then the Rear Light(Green) start flashing quickly, finally it goes off, at that time, the Front Lights(Red) become flashing slowly from stay on.

• **Step 2: Power on Remote Controller**

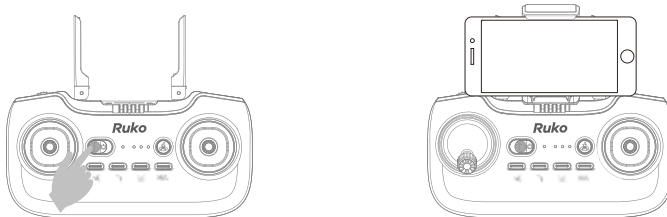

- Unfold the remote control antenna and install mobile phone holder.
- Turn on the remote control power, the transmitter sounds beep, all the indicator lights are flashing quickly.
- Pulling the Left Joystick down and to 6 o'clock position and let go, the transmitter sounds beep, the first LED indicator (Red) of transmitter stays on from flashing quickly,the second LED indicator (Blue) of transmitter is flashing slowly, the drone and the remote control are successfully connected, then you can continue with the next step.
- Tips: It takes about 30 seconds for the drone to connect to the remote control.

! • Installing/Removing Phone Holder

Installing

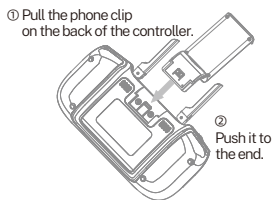

Removing



• Step 3: Connect the Wi-Fi and APP

Wi-Fi Connect  Ruko-U11 Pro-XXXX

The required Operating System of the phone must be iOS 9.0 or later/ Android 5.0 or later. This drone will be compatible with the phones which's WLAN function is dual-band Wi-Fi (2.4GHz and 5.8 GHz).

For iOS system:

Connect the Wi-Fi "Ruko-U11Pro-XXXXXX" with your phone.

For Android system:

① After connecting with the drone's Wi-Fi "RUKO-U11Pro-XXXXXX" please wait for about 10-30 seconds.

② Note if there is any option popping up about internet settings, Please keep connected, otherwise, there is no picture after entering APP.

③ If still without a Wi-Fi connection, please turn on your phone's airplane mode for a few seconds, then turn off the airplane mode and open the Wi-Fi list to connect it again.

*Note: Need to turn off the VPN. VPN will affect Wi-Fi connection.



App Connect

① Check the drone's status on the App ""RUKO GPS"".

② Tap "Go Flying", then set the flight parameter what you want on App, such as Max Distance, Max Altitude and Return Altitude.



Refer to the APP section of User Manual for more information about Flight Setting and Beginner Mode.

• **Step 4: Compass Calibration**

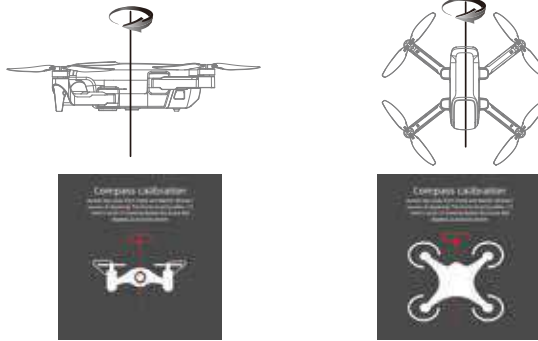

① Compass Horizontal Calibration

Keeping the drone level, pick up the drone and rotate the drone 3 times horizontally at the App prompt.

The transmitter sound beep, the horizontal Calibration is done when the Front LED Light (Red) stays on, Rear LED Light is flashing,

You can continue with the next step when APP is prompt to enter Vertical Calibration.

② Compass Vertical Calibration

Keeping the drone vertical, pick up the drone and rotate the drone 3 times vertically according to the App prompt.

The transmitter sound beep, the transmitter sound beep, the Vertical Calibration when the LED Light of drone is flashing in turn, you can continue with the next step.

⊗ • Do the compass Calibration before flying each time, or it may can't work normally.

• **Step 5: Gyroscope Calibration**

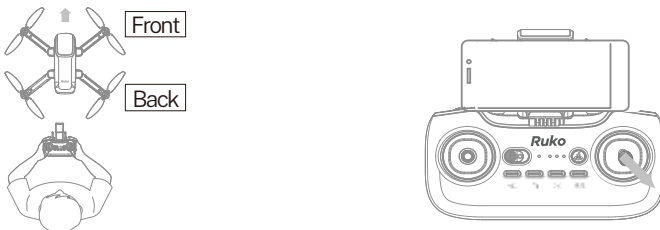

Always keep the head of drone facing forward.

- ① Place the drone on horizontal ground.
- ② Push the Right Joystick into 5 o'clock position for 2-3 seconds.
- ③ All LED Lights are flashing quickly, then the LED Light of the drone is flashing slowly in turn. You can continue with the next step.

• Step 6: Searching GPS Signal



- ① It will automatically search for GPS signals after successful frequency matching, just wait for 1-2 minutes(depends on the performance of smartphone and environment).
 - ② The searching GPS signal is done when the transmitter sound beep.
 - ③ Notice the GPS signal on App, the Rear LED Light of the drone and the blue LED light of the transmitter stays on at the same time, the transmitter sound beep, at that time searching the GPS signal is successful. You can continue with the next step.
- ✓ • It is recommended to fly in an environment that the GPS signal is equal to or greater than 8.
 - DO NOT Long press the GPS button to turn off the GPS mode during flying outdoor, or it may not work normally.

• Step 7: Starting/Stopping the Motors

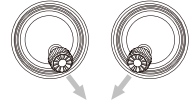
- ① Starting the motors: Push the Left Joystick inward into the 5 o'clock position and the Right Joystick inward into the 7 o'clock position at the same time, hold on for 2-3 seconds and let go.
- ② Stopping the Motors: Repeat the above step to stop the motors.



How to Take off/Landing

- ① Push the Left Joystick up, the drone will take off directly. Push the Left Joystick down, the drone will land directly.
- ② Tap  on RUKO GPS APP, the drone will take off directly. While flying within the visible bounds, you also can tap it on RUKO GPS to land directly.
- ③ Tap  on RUKO GPS APP or press the  button on the remote control, the drone will automatically return to the take-off point. Recommend to use RTH while flying far away from the take-off point.

- ⚠ • Please start the motor before take off.
 - Always keep the head of drone facing forward.

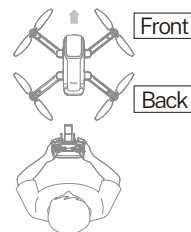

6.4 How to Fly in Indoors



Recommended to hone your flight skills and practice flying safely , flying indoor could be dangerous if improper operation. Refer to the How to Fly in Outdoor Environment section for more information.

- **Step 1: Power On The Drone**
- **Step 2: Power on Remote Control**
- **Step 3: Compass Calibration**
Compass horizontal calibration
Compass vertical calibration
- **Step 4: Gyroscope Calibration**
- **Step 5: Turn off GPS Mode**
- **Step 6: Starting/Stopping the Motors**



✓ Fly Indoor



• How to turn off GPS Mode while flying indoor?

Long Press (3 seconds) the GPS button on remote control until the Blue LED Light of controller goes off. When in low battery, it will return to the 30m (98 ft) RTH altitudes above the Take-off Point.

*GPS needs to be turned off before the indoor flying.

7 Warning

- There is important information contained in this package and instruction manual, please keep it for future reference. Refer to the Disclaimer & Safety Guidelines for more safety information. You have the responsibility to make sure that this model of aircraft won't cause injury to others bodies or cause any damage to property.
- RUKO and distributors won't be responsible for any incorrect operation, which may cause loss or damage, or injury to the body.
- Children ages 14 and up should use this product under the guidance of an adult. This product is FORBIDDEN to be used by children under 14 years old.

- Please correctly assemble and use this product as shown on the instruction manual or packing instruction. Some parts should be assembled by an adult.
- Small parts are included with this product, Please place it beyond the reach of the children to avoid a CHOKING HAZARD or parts being mistakenly swallowed.
- Playing on the road or near high traffic areas is strictly FORBIDDEN so as not to cause an accident.
- Please dispose of the packing material timely so as not to cause injury to children.
- DO NOT disassemble or re-equip the aircraft as it may cause a breakdown of the aircraft during flying.
- Batteries in the battery compartment of the charger should be inserted into the designated power source which has the same logo as the product.
- DO NOT make it short-circuited or squeeze the battery so as not to cause an explosion.
- DO NOT mix the Li-ion battery with a different type of battery.
- DO NOT make the battery short-circuited or decompose the battery or throw the battery into the fire; DO NOT place the batteries near the high temperature or heated area (such as near the fire or near the electric heating device).
- The drone should be kept far away from any other electric compliance or equipment as far as possible or kept far away from the place where having the magnetic object nearby may cause interference with each other.
- Please keep a safe distance from the high-speed rotating rotor so as not to cause twists or danger of being wounded or being cut.
- Engine will heat up. DO NOT touch it to avoid being burned or injured.
- DO NOT close this product to your ear as it may cause injury to your hearing.



CONTACT US FOR MORE TECH SUPPORT

✉ rukofunnytoys@gmail.com

☎ +1(949) 394-4635 (Available from 6pm to 3am PST)

Printed in China.

8 Specifications

Drone	
Mode	U11 Pro
Weight (Including Battery)	278g/9.80Z
Dimensions (L x W x H)	Unfold: 9.05x10.4x2.36inch Folded: 5.91x3.94x2.36inch
Max Rise Speed	2m/s
Max Down Speed	1.6m/s
Max Horizontal Flight Speed (Windless Conditions)	3m/s(Low Speed) 6m/s (Default Speed) 8m/s(High-Speed)
Max Flight Height	393ft
Operating Temperature Range	0° to 40°C
Operating Frequency	5.15-5.35 GHz; 5.725 - 5.825 GHz
Transmit Power	< 24dbm
Satellite Systems	GPS / GLONASS
Controller Range of Camera (Up and Down)	About-90°TO+0°
Camera	
Equivalent Focal Length	2.5M
Focus Range	Fixed-focus
Resolution of Photo	Phone: 3840x2160P SD Card: 2048x1152P
Resolution of Video	Phone: 1280x720P SD Card: 2048x1152P
Photo Format	JPG
Video Format	MP4
Supported SD Cards	Micro SD card(Class10/U1 or later)32G or less
Operating Temperature Range	0° to 40°C
Mobile Device Holder	4.7"to 6.5" Smart Phones
Image Transmission	
Operating Frequency	5.15-5.35 GHz; 5.725 - 5.825 GHz
Supported Transmission Protocol	802.11a; 802.11n20; 802.11n40
Video Transmission Frame Rate	25FPS
Real-time image transmission	720p/25fps
Battery	
Capacity	Drone:1900 mAH Transmitter:1200mAH
Voltage	Drone:7.6V Transmitter:3.7V
Battery Type	Li-polymer
Power	15W
Charging Time	About 2.5 hours
Charging Temperature Range	0° to 40°C
Chargig Cable	
Input	100V to 240V, 50/60Hz, 0.5A
Output	5V/1.5A or 5V/2A or 5V/3A
Rated Power	≤15W
APP Name	
APP Name	RUKO-GPS
Mobile Device System Version	OS 9.0 or later/ Android 5.0 or later

Ruko[®]

www.rukotoy.com