

RUNNER 250

QUICK START GUIDE **V1.1**

6th-NOV-2015

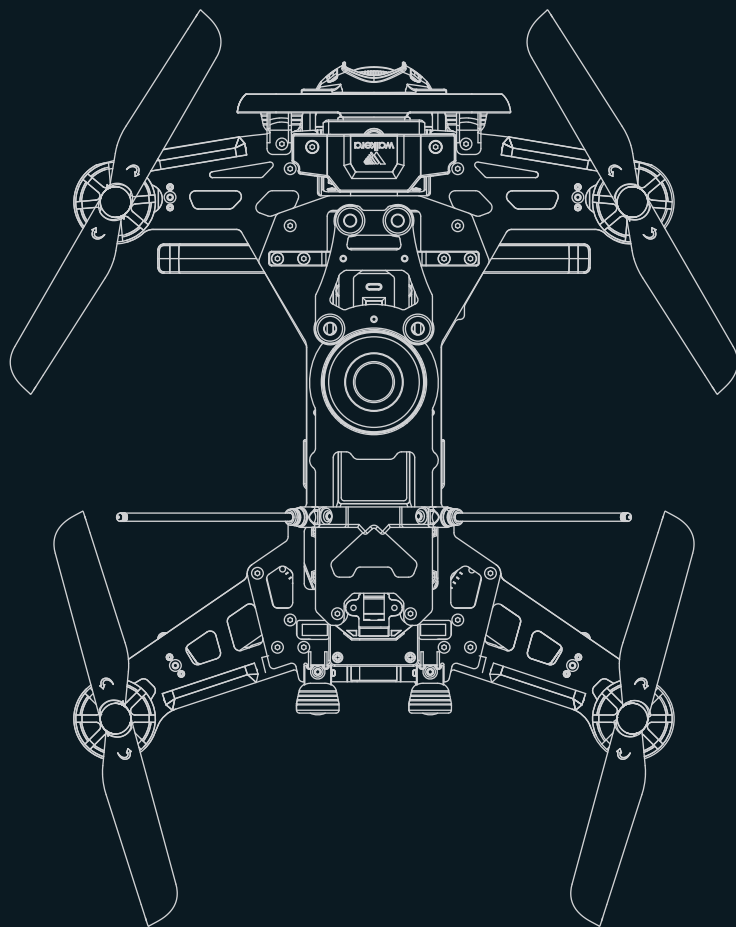

Contents

| | |
|--|-------|
| 1.0 Get to know your aircraft | 2 |
| 2.0 Get to know your Remote Controller | 3 |
| 3.0 Specifications | 4 |
| 4.0 Attention before flight | 5 |
| 5.0 Charge the Battery | 5 |
| 6.0 Assemble | 6 |
| 7.0 Ready for flight | 7 |
| 7.1 Binding of the Runner 250 | 7 |
| 7.2 Motor Unlock / Lock | 8 |
| 7.3 Flight mode indicator light instruction | 8 |
| 8.0 Operation Instruction | 9-10 |
| 9.0 End flight | 10 |
| 10.0 Additional remark | 11 |
| 10.1 DEVO F7 Remote Controller Setting | 11-12 |
| 10.2 DEVO 7 Remote Controller Setting | 13-14 |
| 10.3 TX5816(FCC)/TX5817(CE) emitter transmitting channel selection | 14 |
| 10.4 Introduction for power plate | 15 |
| 10.5 Introduction for RUNNER 250 OSD(C) | 16 |
| 10.6 Introduction for DEVO-RX710(R) receiver | 16 |
| 10.7 Introduction for FCS-RUNNER 250(C) Main Controller | 17 |
| 10.8 Blushless ESC and Blushless Motor connection diagram | 17 |
| 11.0 Camera(1920x1080P) Instructions | 18-19 |
| 12.0 Instructions for balance charger | 20-21 |

1.0 Get to know your aircraft

- Adopting the CFP material for the main body, the racer possesses superior toughness and strong anti-impact ability.
- The brand new industrial and modular design, greatly improve the product extension, which enable it much easier to maintain and upgrade.
- The 5.8G real-time image transmission system and OSD system, can bring you the unforgettable visual enjoyment.
- The racer can do acrobatic flights such as roll up-to-down, left-to-right, dream baron. Which gives the user unparalleled flight enjoyment.

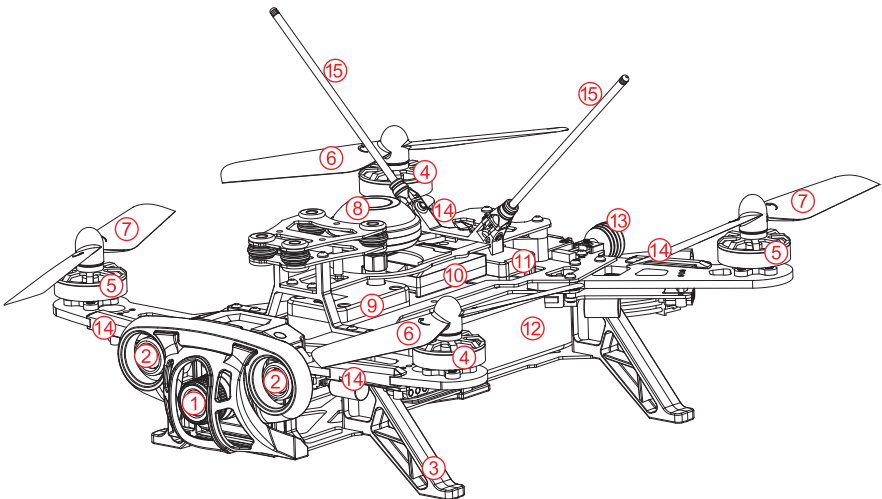



1. Camera
2. White LED light x2
3. Landing gear x4
4. Clockwise motor (levogyrate thread is counterclockwise)
5. Counterclockwise motor (dextrogyrate thread is clockwise)
6. Clockwise propeller
7. Counterclockwise propeller
8. Mushroom antenna
9. TX5816(FCC)/TX5817(CE) emitter
10. Main Controller
11. DEVO-RX710(R) Receiver
12. Li-Po Battery
13. Red LED light x2
14. Direction indicator light x4
15. Receiver antenna

2.0 Get to know your Remote Controller

DEVO-F7 in-built with the 5.8G Image transmission system, easy to receive the aerial photos. Equip with the Primary Flight Mode/Intermediate Flight Mode/Advanced Flight Mode, camera control etc function switch, the runner 250 is easier to control. **(You can select suitable flight mode according to your flying skill.)**

| | | |
|--|-------------|-----------------|
| MODE 2 (Throttle stick on the left) | Left stick | THRO/RUDD stick |
| | Right stick | ELEV/AILE stick |
| | Left trim | THRO trim |
| | Right trim | ELEV trim |
| MODE 1 (Throttle stick on the right) | Left stick | ELEV/RUDD stick |
| | Right stick | THRO/AILE stick |
| | Left trim | ELEV trim |
| | Right trim | THRO trim |

| Primary Flight Mode | Intermediate Flight Mode | Advanced Flight Mode |
|---|---|---|
|  |  |  |
| MIX Switch to "0" | MIX Switch to "1" | MIX Switch to "2" |

1. HOLD TRN switch
2. GEAR switch - Camera start/Stop
3. AUX2 control
4. Left stick
5. Left trim
6. RUDD trim
7. UP+ key
8. DN- key
9. EXT key
10. FMOD Switch

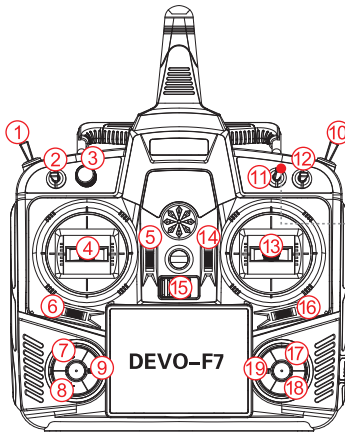

11. MIX - Flight Mode Switch
12. ELEV/AILE/RUDD D/R Switch
13. Right stick
14. Right trim
15. Power switch
16. AILE trim
17. R+ key
18. L- key
19. ENT key

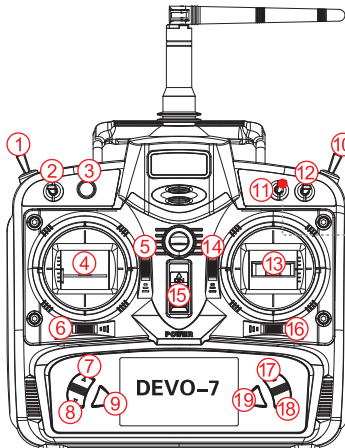

3.0 Specifications

Aircraft

Main Rotor Dia.: 143mm
 Overall (L x W x H): 236 x 205 x 102mm
 Weight: 446g (Battery excluded)
 Remote Controller: DEVO F7/DEVO 7
 Receiver: DEVO-RX710(R)
 Emitter: TX5816(FCC)/TX5817(CE)
 OSD: Runner 250 OSD(C)
 Flight Time: 10~12mins
 Working Temperature: -10 C ~ +40 C

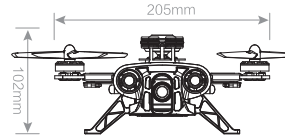
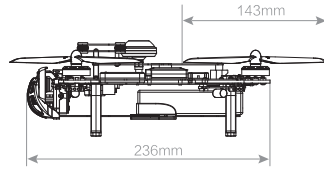

a. Basic version

Brushless Motor: WK-WS-28-014(CW/CCW)
 Brushless ESC: Runner 250
 Main Controller: FCS-RUNNER 250(C)
 Li-Po Battery: 11.1V 2200mAh 25C 3S
 Balance charger: GA005

b. Advance version

Brushless Motor: WK-WS-28-015(CW/CCW)
 Brushless ESC: Runner 250(C)
 Main Controller: FCS-RUNNER 250(C1)
 Li-Po Battery: 14.8V 2000mAh 30C 4S
 Balance charger: GA009

Camera(1920x1080P)

Video Resolution: 1920x1080P 60FPS
 Micro SD card: Max 32G
 Video Format: MOV
 Photo: 4000x3000 Pixels
 Photo Format: JPG
 Power Input: DC 5V

Camera(800TVL)

Horizontal Resolution: 800TVL
 System Committee: PAL/NTSC
 Video Out: 1.0Vp-p/75Ω
 Power Input: DC 12V

TX5816(FCC) / TX5817(CE) Emitter

5.8G wireless image transmission
 TX5816(FCC) Bind B section: 4 channels
 TX5817(CE) B section: 8 channels
 TX5816(FCC) output power ≤200mW
 TX5817(CE) output power ≤25mW

4.0 Attention before flight

- This product is suitable for people who has flight experience of hobby model and ages 14+.
- Please do not fly the runner 250 advance in the situation that the windpower is more than level 3, either in rainy, sowny or foggy etc bad weather.
- Please choose the open, legal field to fly, and consider your flight skills and mental status.
- Please keep a certain distance with aircraft and away from the highspeed rotating parts (such as propellers, brushless motor) during flying.
- Do not fly it in where there is high-voltage lines, communication base stations or radio towers, in order to avoid signal interference.
- Don't fly in no-fly zone according to the local laws and regulations.

5.0 Charge the Battery

5.1 GA005 charger

- ① Insert the power adapter(100~240V 50/60HZ), connect the output end to the GA005 balance charger, the balance charger is red LED at this time.
- ② Insert the balanced pin of LiPo battery into GA005.
- ③ During charging, Red LED is continuously flashing. If saturated, Red LED becomes solid green lighting.



Attention:

Please refer to Page 20 for details of GA005 balance charger.

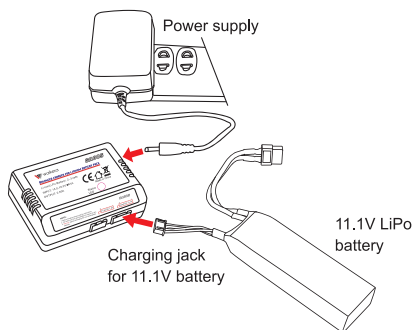

5.2 GA009 charger

- ① Insert the power adapter(100~240V 50/60HZ), connect the output end to the GA009 balance charger, the balance charger is green LED light flashing.
- ② Insert the balanced pin of LiPo battery into GA009.
- ③ During charging, the red LED light is solid. When the charger will be completed, the red and green LED lights flash alternately. The charging is completed, the green LED light is solid.



Attention:

(1) When the yellow LED light flashes, there may be something wrong with charger or battery, so please stop charging

(2) Please refer to Page 21 for details of GA009 balance charger.

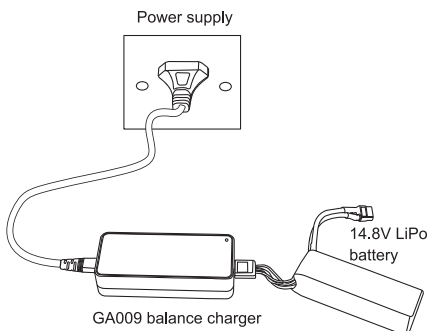

6.0 Assemble

Install propellers

Fix the clockwise propeller onto the clockwise motor according to the direction of blue arrow, and fix the counterclockwise propeller onto the counterclockwise motor according to the direction of orange arrow.

Tighten the propellers manually and make sure the propeller is installed in proper way and fastened.



Attention:

To convenient install or take off the propellers, please use the open-end wrench to hold the motor side hood (shown at right).

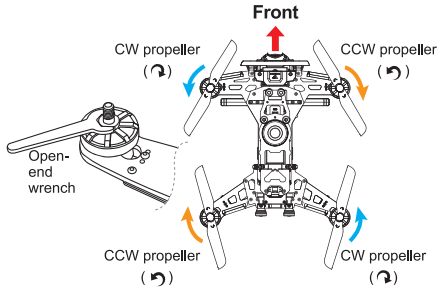

Battery installation

Put the battery and the Battery anti-slip mat into the Runner 250, balance the gravity, keep the head and the tail parts aligned, then fasten the battery with the Velcro strap.

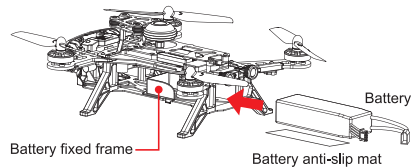

Gravity center adjustment:

Hold the gravity center line for the fulcrum to balance it. If the head inclines to drop, indicates the gravity center in the head part, require to move the battery backward;

On the contrary, If the tail inclines to drop, indicates the gravity center in the tail part, require to move the battery forward.

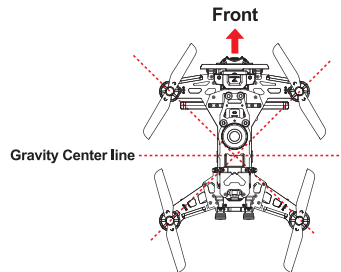

Attention:

The receiver antenna has to be straightened before the flight, to lengthen the communication distance.

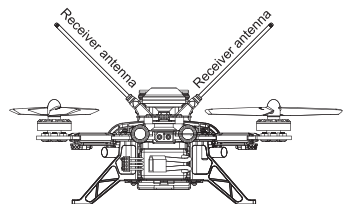

7.0 Ready for flight

 **Attention:**

- (1) Place the aircraft on a flat surface, in an open space, with the back facing you.
- (2) Put all the function switches to the 0 position, put all trims/knobs to the Middle position, move the throttle to the lowest position, then turn on the Remote Controller.
- (3) The runner 250 has low voltage warning, no low voltage protection.
 - a. When the battery voltage is low, the direction lights will flash slowly and the buzzer will alarm.
 - b. With 11.1V li-po battery, if the voltage is less than 10.4V and the aircraft should be landed ASAP to avoid crashing.
 - c. With 14.8V li-po battery, if the voltage is less than 14.2V and aircraft should be landed ASAP to avoid crashing.

7.1 Binding of the Runner 250

- ① Turn on the Remote Controller. (Make sure all the function switches, all trims/kobs and throttle stick at the correct position)

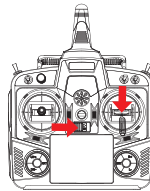

- ② Put the aircraft to the horizontal place and connect the aircraft power. (make sure the positive and negative connected correctly)

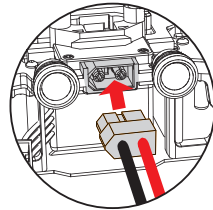

- ③ The rear red LED flashes from fast to slow indicating that the code binding has finished.
(Note: When binding, do not move the runner 250.)

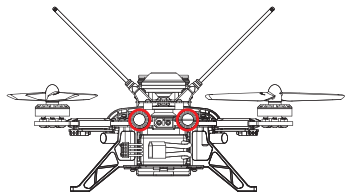

7.2 Motor Unlock / Lock

• Motor Unlock

After binding the DEVO F7/DEVO 7 to the Runner 250, Check that all trims are neutral, the throttle stick is ALL the way Down with the display indicating 0% throttle. Check that ALL switches are in the UP position. Gently push the throttle stick down and move the rudder (YAW) stick to the left side and **hold for more than 2 seconds**. (on mode 2 radios throttle and rudder is the same stick). You will see the rear red LED light flash fast, indicating that motors are unlocked. Be very careful at this point, as pushing the throttle up will start the motors. You can test by pushing the stick up a little, the motors should start.

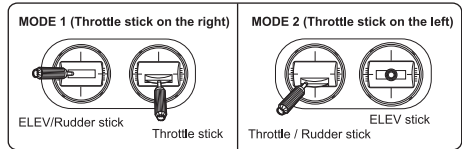

• Motor Lock



Lock the motors by moving the throttle stick all the way down and the rudder (YAW) stick all the way to the right. The rear red LED light flashes slowly when the motors are disarmed.

TEST: Push the throttle stick up a little, the motors will not start when locked.

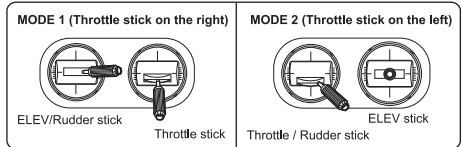

NOTICE: The motors are LOCKED by default after successful binding.



7.3 Flight mode indicator light instruction

| Mode | Remote Controller Switch | The indicator status |
|--------------------------|---|--|
| Primary Flight Mode |  <p>MIX switch to "0" position</p> | The rear red LED of aircraft flashes once quickly |
| Intermediate Flight Mode |  <p>MIX switch to "1" position</p> | The rear red LED of aircraft flash twice quickly |
| Advanced Flight Mode |  <p>MIX switch to "2" position</p> | The rear red LED of aircraft flash 3 times quickly |

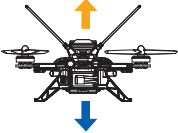
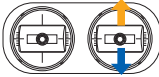
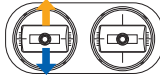
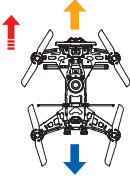
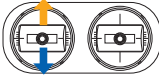
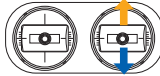
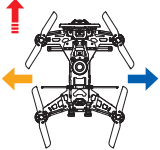
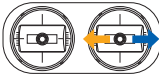
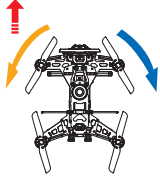
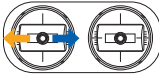
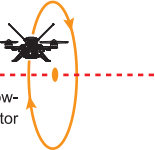
8.0 Operation Instruction

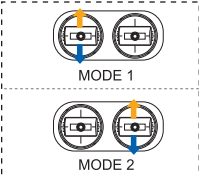
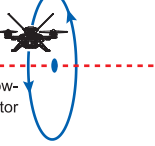
| Aircraft posture(← the direction of head) | Remote Controller control instruction | |
|--|---|--|
| <p>THROTTLE Up/down The tail toward operator</p>  |  <p>MODE 1 (Throttle stick on the right)</p> |  <p>MODE 2 (Throttle stick on the left)</p> |
| <p>PITCH Forward/backward When backward, the left/right direction indicator lights will be solid.</p>  |  <p>MODE 1 (Throttle stick on the right)</p> |  <p>MODE 2 (Throttle stick on the left)</p> |
| <p>ROLL (lean) Left / right When lean left, the left direction indicator light will be solid. When lean right, the right direction indicator light will be solid.</p>  |  <p>MODE 1 / MODE 2</p> | |
| <p>YAW (turn) Left / right When turn left, the left direction indicator light will flash. When turn right, the right direction indicator light will flash.</p>  |  <p>MODE 1 / MODE 2</p> | |
| <p>The aircraft roll forward</p>  <p>The tail toward operator</p> | <p>Ensure the MIX switch on "1" or "2" position, namely Intermediate Flight Mode or Advanced Flight Mode.</p> <div style="display: flex; align-items: center;"> <div style="border: 1px dashed gray; padding: 5px; margin-right: 10px;">  <p>MIX Switch to "1" or</p> </div> <div style="margin-right: 10px;">→</div> <div style="border: 1px dashed gray; padding: 5px;">  </div> </div> | |
| <p>The aircraft roll backward</p>  <p>The tail toward operator</p> | <p>Attention:</p> <ol style="list-style-type: none"> (1) Please select a larger space, soft ground for flying. (2) The rolling mode is more suitable for experienced pilots. (3) Need match the throttle for practice during the rolling, when the aircraft drop please up throttle a bit, when the aircraft rise please down the throttle a little. | |

The aircraft roll left

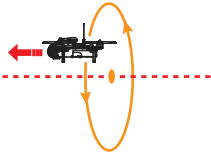

The aircraft roll right

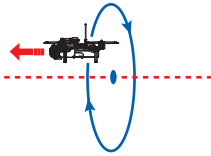

Ensure the MIX switch on "1" or "2" position, namely Intermediate Flight Mode or Advanced Flight Mode.

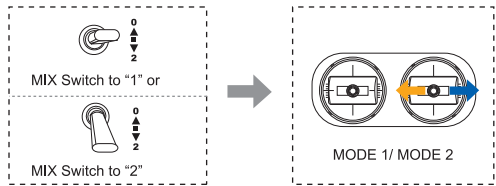

Attention:

- (1) Please select a larger space, soft ground for flying.
- (2) The rolling mode is more suitable for experienced pilots.
- (3) Need match the throttle for practice during the rolling, when the aircraft drop please up throttle a bit, when the aircraft rise please down the throttle a little.

Dream Baron

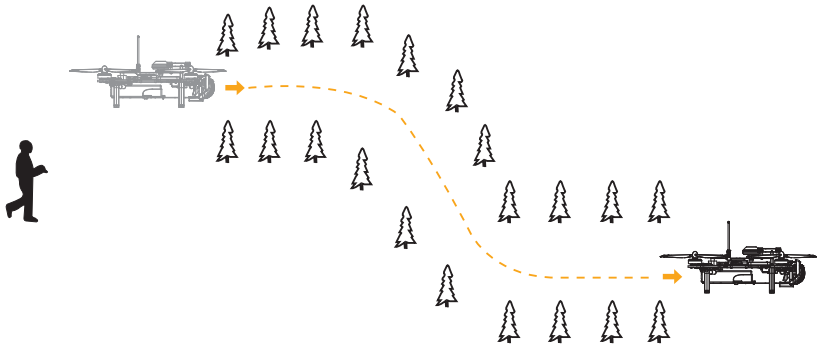

Attention:

- (1) Dream Baron is more suitable for experienced pilots.
- (2) During the flying, please keep in sight of 50 meters or video control range within 300 meters to control the flight. (Actual range depending on the flight environment and weather conditions.)
- (3) During the flying, please avoid obstacles such as people, animals and power lines.

9.0 End flight

- ① Manual landing.
- ② First, power off aircraft battery, then power off Remote Controller battery.
- ③ Take the battery out of aircraft.

10.0 Additional remark

10.1 DEVO F7 Remote Controller Setting

● Boot Screen(Main interface)

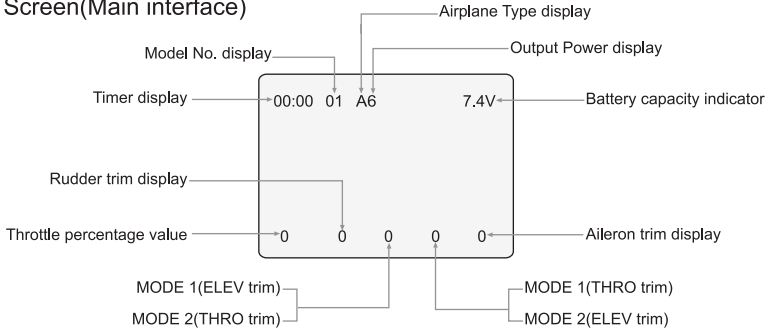

● Model Select

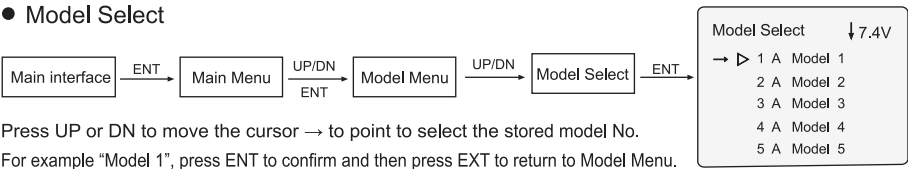

● Model Name

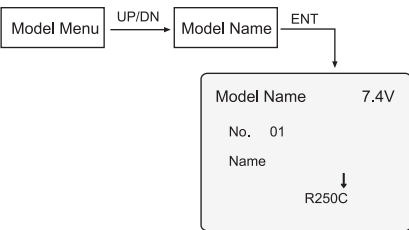

Press UP or DN to move the cursor → to point to select the character and figure which need to be changed, press R or L button to change the character and figure, name model as R250C. Press ENT to confirm and then press EXT to return to Model Menu.

● Type Select

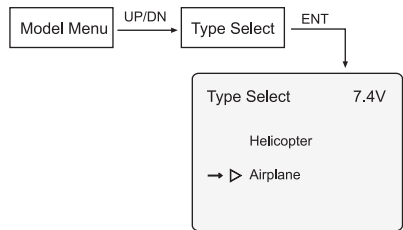

Press UP or DN to move the cursor → to point to Airplane option. Press ENT to confirm and then press EXT to return to Model Menu.

● Wing Type

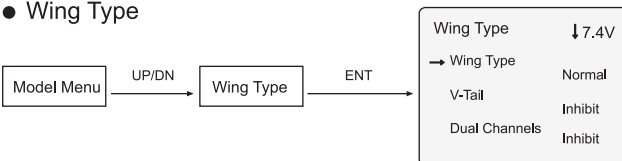

Press UP or DN to move the cursor → to point to Wing Type option, press R or L to select "Normal". Press ENT to confirm and then press EXT to return to Model Menu.

● Device Output

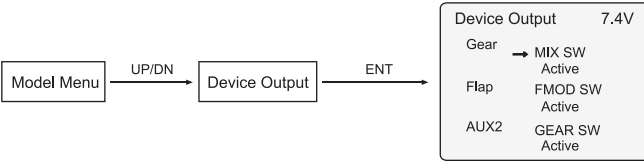

After finish settings, press ENT to confirm and then press EXT to return to Main Menu.

● Reverse Switch

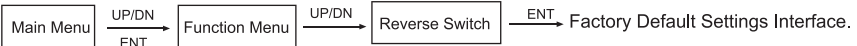

Press R or L to select Normal.
After finish settings, press ENT to confirm and then press EXT to return to Main Menu.

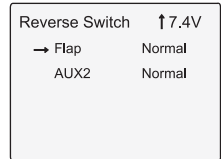
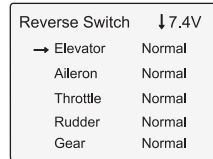

● Video Setting and OSD(C) information

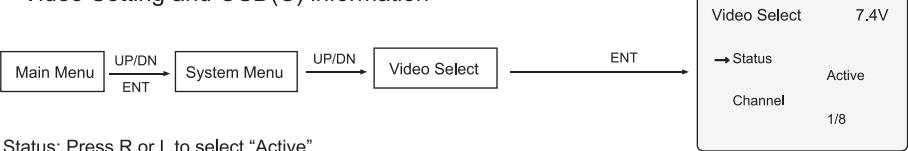

Status: Press R or L to select "Active".

Channel: Press R or L to select suitable receiving video channel for the TX5816/TX5817. It will display automatically "OSD" after connection.

After finish settings, press ENT to confirm and then press EXT to return to Main interface.

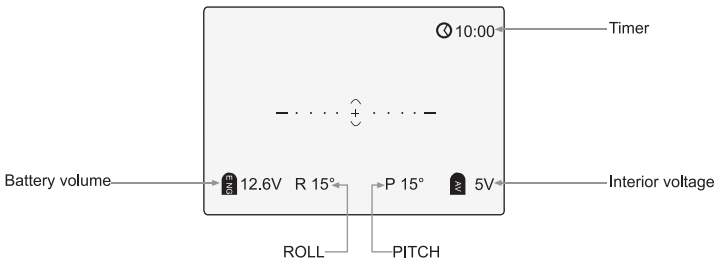

Attention:

Slide the video switch and OSD(C) module code switch "1" to "ON", please refer to page 15~16.

10.2 DEVO 7 Remote Controller Setting

● Boot Screen(Main interface)

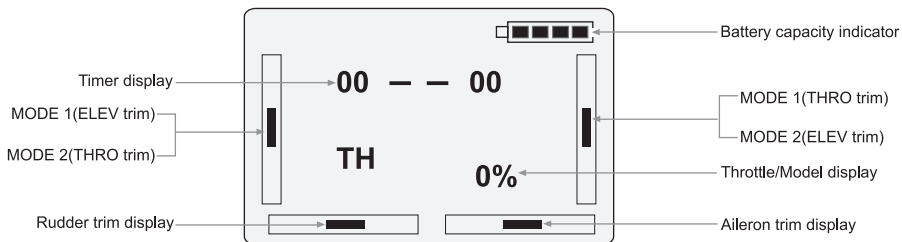

● SELEC

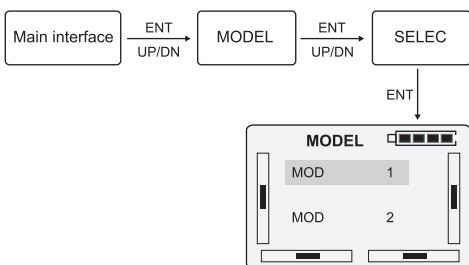

Press UP or DN to select "MOD 1", press ENT to confirm and then press EXT to return to MODEL.

● NAME

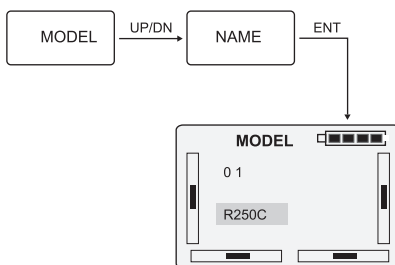

Press R or L button to change the character and figure, named model as R250C. Press ENT to confirm and then press EXT to return to MODEL.

● TYPE

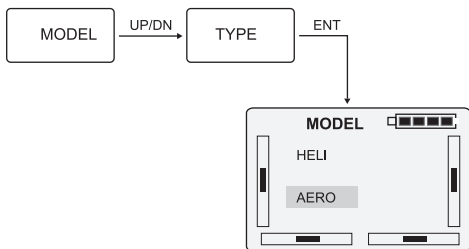

Press UP or DN to select AERO, Press ENT to confirm and then press EXT to return to MODEL.

● WING

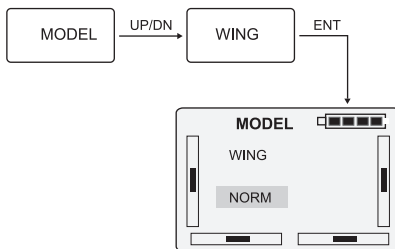

Press R or L to select NORM, Press ENT to confirm and then press EXT to return to MODEL.

● OUTPUT

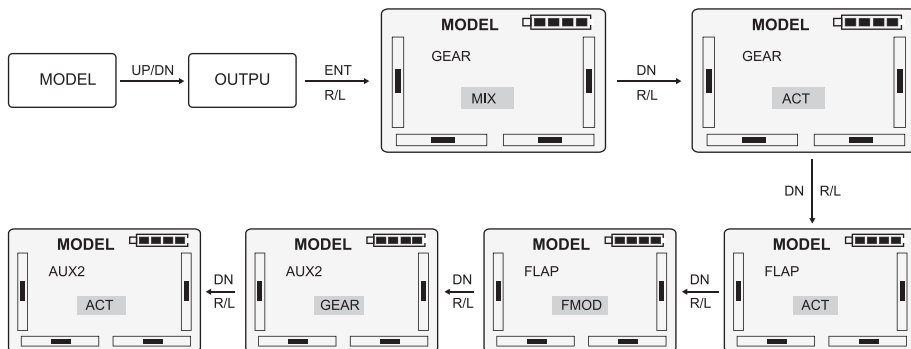

After settings, press ENT to confirm and then press EXT to return to Main interface.

● REVSW

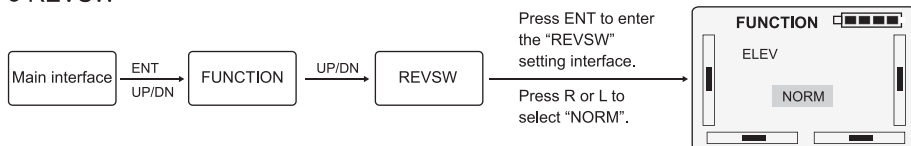

| | | | | | | |
|------|------|------|------|------|------|------|
| ELEV | AILE | THRO | RUDD | GEAR | FLAP | AUX2 |
| NORM | NORM | NORM | NORM | NORM | NORM | NORM |

After settings, press ENT to confirm and then press EXT to return to Main interface.

Tips: The settings of other remote controller of walkera is same as DEVO F7/7.

10.3 TX5816(FCC)/TX5817(CE) emitter transmitting channel selection

There are 8 different channels can be selected. You can choose the best channel according to the image quality as bellow:

| Channel | 1 | 2 | 3 | 4 | 5 | 6 | 7 | 8 |
|------------------------|---------|---------|---------|---------|---------|---------|---------|---------|
| Frequency | 5866MHz | 5847MHz | 5828MHz | 5809MHz | 5790MHz | 5771MHz | 5752MHz | 5733MHz |
| Code position (on/off) | | | | | | | | |



Attention:

- (1) Only 2, 4, 6, 8 channels are available for the TX5816(FCC) emitter.
- (2) Emitter transmitting channel and remote controller image receiving channel must be correspondent with each other.

10.4 Introduction for power board

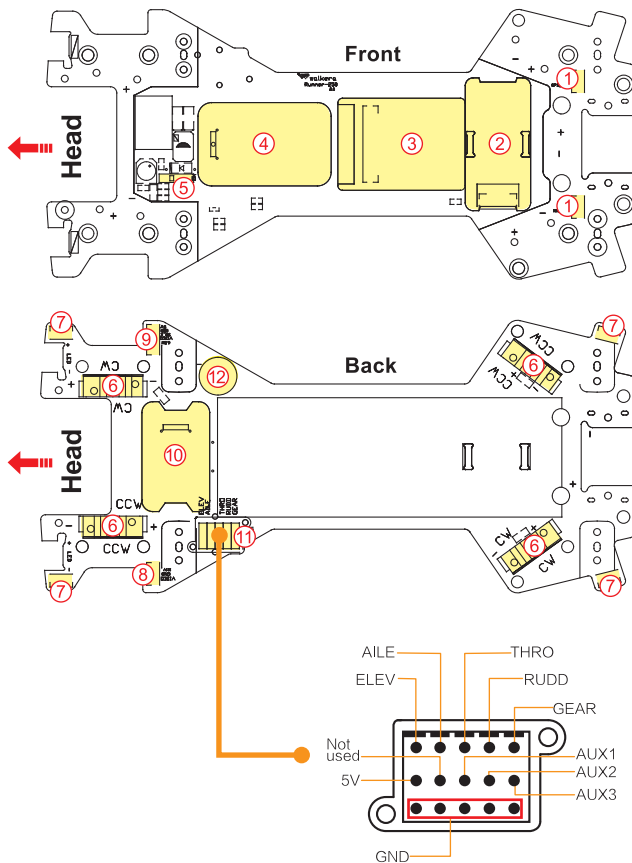

1. Red LED connection port
2. DEVO-RX710(R) Receiver install position
3. Main Controller install position
4. TX5816(FCC) or TX5817(CE) emitter install position
5. Video Switch: OFF ON Slide the switch to "ON" to start the video
6. Brushless ECS connect position
7. Direction indicator light
8. Camera connect Port: (3 pins/11.1V)
9. Camera connect Port: (5 pins/5V)
10. OSD(C) module install position
11. Receiver input/output channel
12. Buzzer: give an alarm when signal lost.
Once the drone lost control signal from the remote controller, the alarm function will be triggered automatically and keep buzzing to help to find the drone.

10.5 Introduction for RUNNER 250 OSD(C)

Upgrade

Please go to Walkera official website for online upgrade, cable connection as follows:

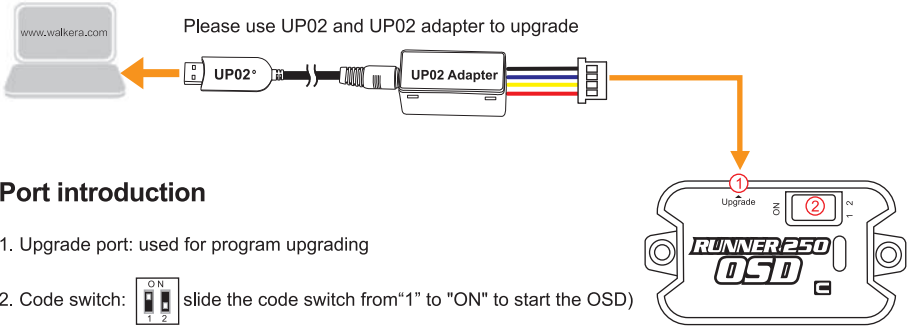

10.6 Introduction for DEVO-RX710(R) receiver

Flexible flat cable connection

The metal surface of flexible flat cable plug should be inserted upward to receiver port properly.



The metal surface of flexible flat cable plug should be inserted downward to power board port properly.

Port introduction

1. Clean button: Fixed ID clear button
2. Idle port: Not used
3. Connection port: used to connect flexible flat cable

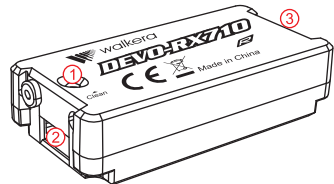

Fixed ID code cleaning up method

If you want to clear the fixed ID after setting by Remote Controller (Fixed ID setting, details please refer the Remote Controller manual), please press the clean button and power on the aircraft. The receiver fixed ID memory is cleared if the receiver RED LED will flash slowly. Remote Controller fixed ID settings status should be OFF.

10.7 Introduction for FCS-RUNNER 250(C) Main Controller

Warm tips:

- (1) Main controller adopts CC3D system, with OSD module(C) can display OSD information.
- (2) The Main Controller intruction of FCS-RUNNER 250(C1) is the same as that of FCS-RUNNER 250(C).

Flexible flat cable connection

The metal surface of flexible flat cable plug should be inserted upward to main controller port properly.



The metal surface of flexible flat cable plug should be inserted downward to power board port properly.

Port introduction

1. 4 pins port: Not used
2. 6 pins port: Not used
3. USB port: used for upgrading and setting parameter
4. Connection port: used to connect flexible flat cable

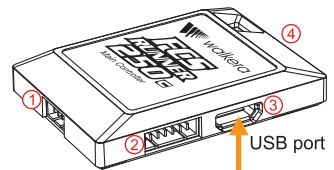

Upgrading and parameter adjustment(OpenPilot GCS)

- (1) Upgrade: please upgrade online via Walkera official website
- (2) Parameter adjustment: please make appropriate parameter adjustment according to your own technical level. Factory files exported before the adjustment is highly recommended.

Connect the main board controller to the computer and run OpenPilot GCS:

Export factory original file: click the window file → select export UAV Settings → name the file and save it

Import factory original file: click the window file → select import UAV Settings → open the saved file

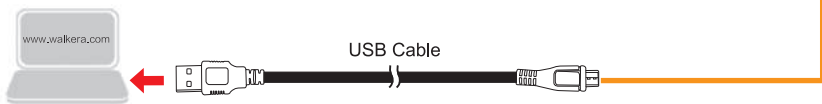

10.8 Blushless ESC and Blushless Motor connection diagram

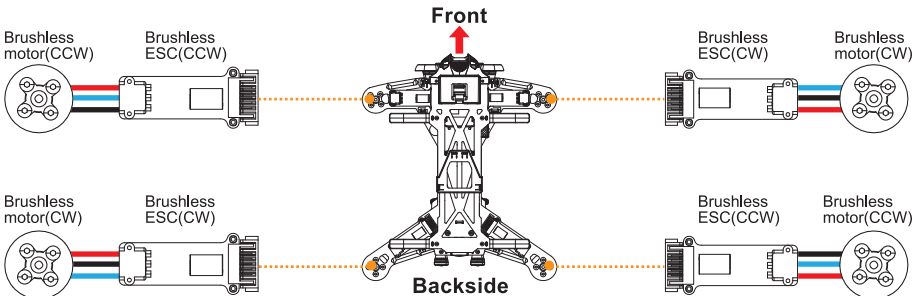

11.0 Camera(1920x1080P) Instructions

11.1 Pictures illustration

1. Shutter Button
2. Red Indicator
3. Power port(DC 5V)
4. Video/Photo Switch
5. Micro SD card slot

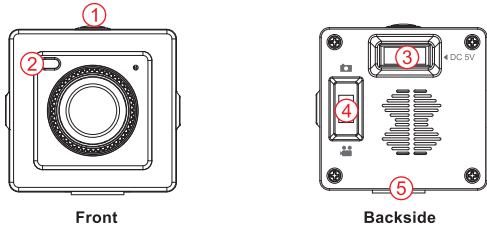

Warm tips:

- (1) A Micro SD card must be inserted into the camera before power on and removed after power off. (A high speed SD card is recommended.)
- (2) Insert the Micro SD card, after the camera power on, the red indicator will keeps solid.

11.2 Video instruction

● Manual Operation

Turn the Video/Photo Switch to , press the shutter button once to start recording (the Red indicator flashes for 0.5sec interval); Press the shutter button again to stop recording (The Red indicator keeps solid).

● Remote Controller Operation

| Switch | Remote Controller setting | Instructions |
|--------|---------------------------|---|
| GEAR | Model Menu | ① Please turn the video/photo switch to “  ” position. |
| | ↓ | |
| | Device Output | ② Start video: turn the GEAR switch from “0” position to “1” position, wait for 1-2 seconds, then return to the “0” position, the camera will start recording (the red indicator keeps flashing with an interval of 0.5 second). |
| | ↓ | |
| | AUX2 | Stop recording: turn the GEAR switch from “0” position to “1” position, wait for 1-2 seconds, then return to the “0” position, the camera will stop recording (the red indicator keeps solid red). |
| | ↓ | |
| | GEAR SW | |
| | ↓ | |
| | Active | Note: You must stop recording to store the video on the SD card. The video will not be stored if you turn off the power before stopping the recording. |

11.3 Photo instruction

- Manual Operation

Turn the video/photo switch to , press the shutter button once, camera will take a photo (the red indicator light out once then keeps solid red), press the shutter button again, it will take another photo.

- Remote Controller Operation

| Switch | Remote Controller setting | Instructions |
|-------------|---|--|
| GEAR | <p>Model Menu</p> <p>↓</p> <p>Device Output</p> <p>↓</p> <p>AUX2</p> <p>↓</p> <p>GEAR SW</p> <p>↓</p> <p>Active</p> | <p>① Please turn the video/photo switch to “  ” position.</p> <p>② Turn the GEAR switch from “0” position to “1” position, wait for 1-2 seconds, then return to the “0” position, the camera will start to take a photo (the red indicator light out once then keeps solid red), operate again to take another photo, and so on.</p> |

12.0 Instructions for balance charger

12.1 Instructions for GA005 balance charger

● Parameters of GA005 balance charger

| Input voltage | Input current | Output current | Dimension |
|---------------|---------------|----------------|--------------------|
| DC15-18V | 1000mA | ≤800mA | 62.5 x 47 x 20.8mm |

● Instruction of GA005 balance charger

- (1) GA005 utilizes microcomputer chips to monitor and control over the whole charging process in a balanced way with LED indicator to display the charging status at real time.
- (2) Connects to an input power supply (DC 15-18V 1000 mA).
- (3) GA005 is suitable for 7.4V/ 11.1V Li-ion or Li-polymer battery pack.
- (4) GA005 can detect Li-Po battery automatically. GA005 will automatically charge when it finds the voltage of single cell battery is excessively low. At the same time LED displays as charging status (flash in red). Control single cell battery voltage at the range of $4.2 \pm 0.05V$ to ensure the maximum voltage difference of single cell in the battery is less than 50 mV.

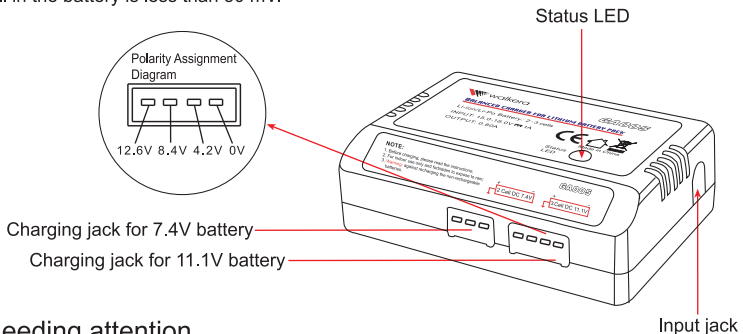

● Matters needing attention

- (1) GA005 is only used to charging a 2S or 3S Li-ion or Li-polymer battery. It is forbidden to simultaneously charge two or more sets of batteries. Either the charger or battery may be damaged.
- (2) During charging, GA005 should be put in dry and ventilated place and be far away from heat sources and inflammable and explosive substances.
- (3) When charging, the battery should be removed from your helicopter. Never leave the charger unsupervised during the process of charging in order to avoid risk of accidents.
- (4) Never immediately charge your battery as soon as the flight is finished, or when its temperature doesn't cool down. Otherwise the battery will take a risk in swelling, even a fire.
- (5) Ensure the correctness of polarity before connecting the battery to charger.
- (6) Avoid drop and violence during the process of charging. Drop and violence will result in internal short circuit of the battery.
- (7) For the sake of safety, please use original charging equipment (wall adapter + GA005 balance charger) and battery. Please change new one in time when the old battery pack is becoming swollen due to long time usage.
- (8) If it is retained in the charger for a long time after saturated, the battery may automatically discharge. When the charger detects that the voltage of individual cells is lower than the rated voltage, it will re-charge until saturated. Frequently charging and discharging will shorten the lifetime of your battery.

12.2 Instructions for GA009 balance charger

● Parameters of GA009 balance charger

| Input voltage | Output current | Output Power | Dimension |
|------------------|----------------|--------------|-----------------|
| 100-240V 50/60HZ | 3.3A | 60W | 137 x 57 x 32mm |

● Instruction of GA009 balance charger

- (1) GA009 utilizes microcomputer chips to monitor and control over the whole charging process in a balanced way with LED indicator to display the charging status at real time.
- (2) GA005 is suitable for 11.1V/ 14.8V Li-ion or Li-polymer battery pack.

● The diagram of CA009 charger connecting to 11.1V li-po battery

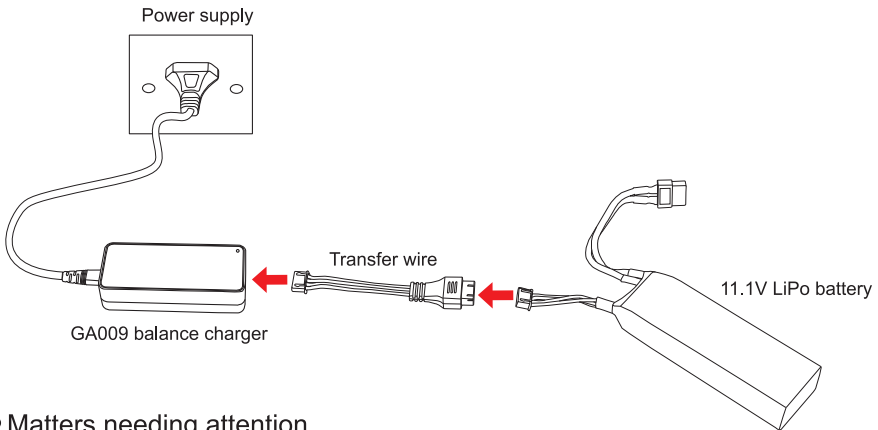

● Matters needing attention

- (1) GA009 is only used to charging a 3S or 4S Li-ion or Li-polymer battery. It is forbidden to simultaneously charge two or more sets of batteries. Either the charger or battery may be damaged.
- (2) During charging, GA009 should be put in dry and ventilated place and be far away from heat sources and inflammable and explosive substances.
- (3) When charging, the battery should be removed from your aircraft. Never leave the charger unsupervised during the process of charging in order to avoid risk of accidents.
- (4) Never immediately charge your battery as soon as the flight is finished, or when its temperature doesn't cool down. Otherwise the battery will take a risk in swelling, even a fire.
- (5) Ensure the correctness of polarity before connecting the battery to charger.
- (6) Avoid drop and violence during the process of charging. Drop and violence will result in internal short circuit of the battery.
- (7) To make sure the safe use, please ensure you use the factory's charger and battery. If the battery is aging and swelling owing to long time using, please replace it in time.



User manual is subject to change without prior notice.
Please go to Walkera official website to get the latest version.

Please scan the following code, to get more information.



 Tel: 400-9318-878