

# ScoutX4

deVention

- Auto Take off
- Auto Landing
- Follow me mode
- Circle flight
- Fence flight
- Single Waypoint flight
- Altitude hold mode
- One key Return To Home
- Automatic Cruise
- IOC mode
- Backtracking
- Waypoint record

## Match with **GCS Ground Station Software** **Quick Start Guide and Systems Flowchart**

### ● Specifications:

Main Rotor Dia. : 233mm

Overall (L x W x H): 335 x 335 x 275mm

Weight: 1770g(Battery included)

Takeoff Weight: <2270g

Transmitter: DEVO F12E

Receiver: DEVO-RX707(CE) / RX709(FCC)

Brushless Motor: WK-WS-34-002

Brushless ESC: WST-16AH (R/G)

Main Controller: FCS-X4

Battery: 22.2V 5400mAh Li-Po

Ground Station: GCS

2.4G Bluetooth Datalink: BT-2401A(FCC) / 2401B(FCC)  
BT-2402A(CE) / 2402B(CE)



- M1/M3 rotate in clockwise, motors are the levogyrate thread.
- M2/M4 rotate in counterclockwise, motors are the dextrogyrate thread.
- When assemble the propellers, rotating direction is oppsite to the arrow direction, the directions are the same when take down the propellers.

# Contents

1.0 Devices that support Ground Station: Android and Apple phone	1
2.0 Download and install software	1
3.0 Installing the Propellers	1
4.0 Restore or assemble the skid landing/binding the radio	1-2
5.0 Main screen instructions	3
6.0 Airline compilation illustration	3
7.0 Compass Calibration	4
8.0 G-3D 3-axis brushless Gimbal installation	4
9.0 Installing the iLook+ 1080p camera with 5.8ghz video link	5
10.0 Motor Unlock	5
11.0 Motor Lock	5
12.0 GPS indicator lights	6
13.0 Function and rocker control interface description	6-8
14.0 2.4G Bluetooth Datalink	9-13
15.0 Ground station firmware setting	14-16
16.0 FCS-X4 Main controller guideline	17
17.0 DEVO RX707/RX709 Receiver guideling	17

## 1.0 Devices that support Ground Station: Android and Apple phone

### Android phone requirements:

- (1) The Android version should be 4.0 or above, the screen resolution should be 480 x 800 pixels or above.
- (2) Google play, google play store and TTS firmwares should be preinstalled in the phone.

## 2.0 Download and install software

- (1) Please download the "GCS Ground Station" software from walkera official web ([www.walkera.com](http://www.walkera.com)) / Google for Android version 4.0 above.
- (2) Apple IOS system, Please download the "GCS Ground Station" software from APP Store.

**Suggestion: please set the phone to flight mode when you are using the GCS firmware to control the flight.**

## 3.0 Installing the Propellers

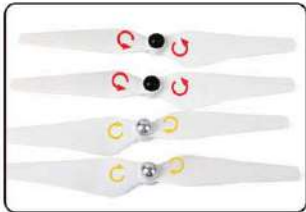

3.1 Prepare forward propeller (Clockwise arrow mark), counter propeller (counterclockwise arrow mark )



3.2 Match the arrows on the propellers to the arrows on the arm next to each motor. Screw each propeller onto the motor, secure by hand, no need for tools.



3.3 Propellers assembled (assembled skid landing)



3.4 Propellers assembled (unassemble skid landing)

## 4.0 Restore or assemble the skid landing/binding the radio

### 4.1 Skid landing assembled(restoration/code binding)

The Landing gear is shipped in the retracted position. **DO NOT try to extend the landing gear by pulling on it.** We will deploy the landing-gear the first time the system is powered, please follow these instructions carefully.



4.1.1 Install the fully charged battery DO NOT turn on the battery until later.  
\*Please check the charger manual for charging instructions



4.1.2 Turn X4 on its back. The belly and the retractable legs should now be facing up. MAKE SURE nothing is blocking the legs.



4.1.3 Turn the power switch to "ON" position, and press on the power button about 3-5 second till the Green power indicator solid.



4.1.4 Turn on the power switch (to position ON) of 2.4G Bluetooth Datalink. The green light of bluetooth will flash quickly, waiting for the connection with the phone bluetooth.

4.1.5 Enter phone settings and open the bluetooth function. In the bluetooth search list find and touch "walkera-\*\*\*\*", input password 1234 to connect and the connection will be successful if it displays "connected". Exit the settings when finished.



4.1.6 Touch GCS icon at middle of the mobile screen, GCS software will search automatically and display matched bluetooth, then select the matched bluetooth and touch GO icon or back to enter into main interface(Skid landing comes back automatically)

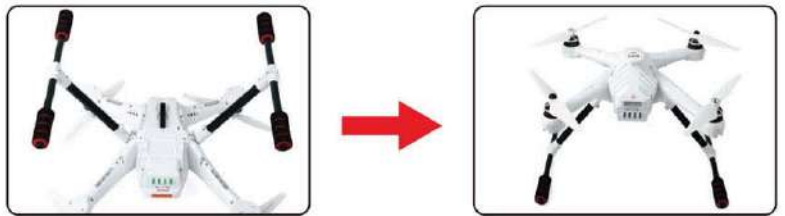

Red LED flashing till to go out means the code binding finished.

After the successful binding place the aircraft on a stable surface.

**4.2 Skid landing unassembled(assemble skid landing/code binding)**

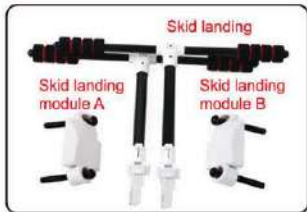

4.2.1 Prepare two skid landing, skid landing module A/B, 4pcs M2.5X20 screws.



4.2.2 Put the skid landing into the skid landing position.

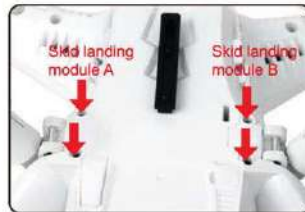

4.2.3 Install the skid landing module, and screw down the M2.5X20 screw to fix skid landing.



4.2.4 Skid landing installation finished.



4.2.5 Put the aircraft on the horizontal position, slide the power-switch to the ON position, then press on the power button for about 3-5 seconds, until the green power indicator lights solid.



4.2.6 Turn on the power switch (to position ON) of 2.4G Bluetooth Datalink. The green light of bluetooth will flash quickly, waiting for the connection with the phone bluetooth.

4.2.7 Enter phone settings and open the bluetooth function. In the bluetooth search list find and touch "walkera-\*\*\*\*", input password 1234 to connect and the connection will be successful if it displays "connected". Exit the settings when finished.



4.2.8 Touch GCS icon at middle of the mobile screen, GCS software will search automatically and display matched bluetooth, then select the matched bluetooth and touch GO icon or back to enter into main interface.

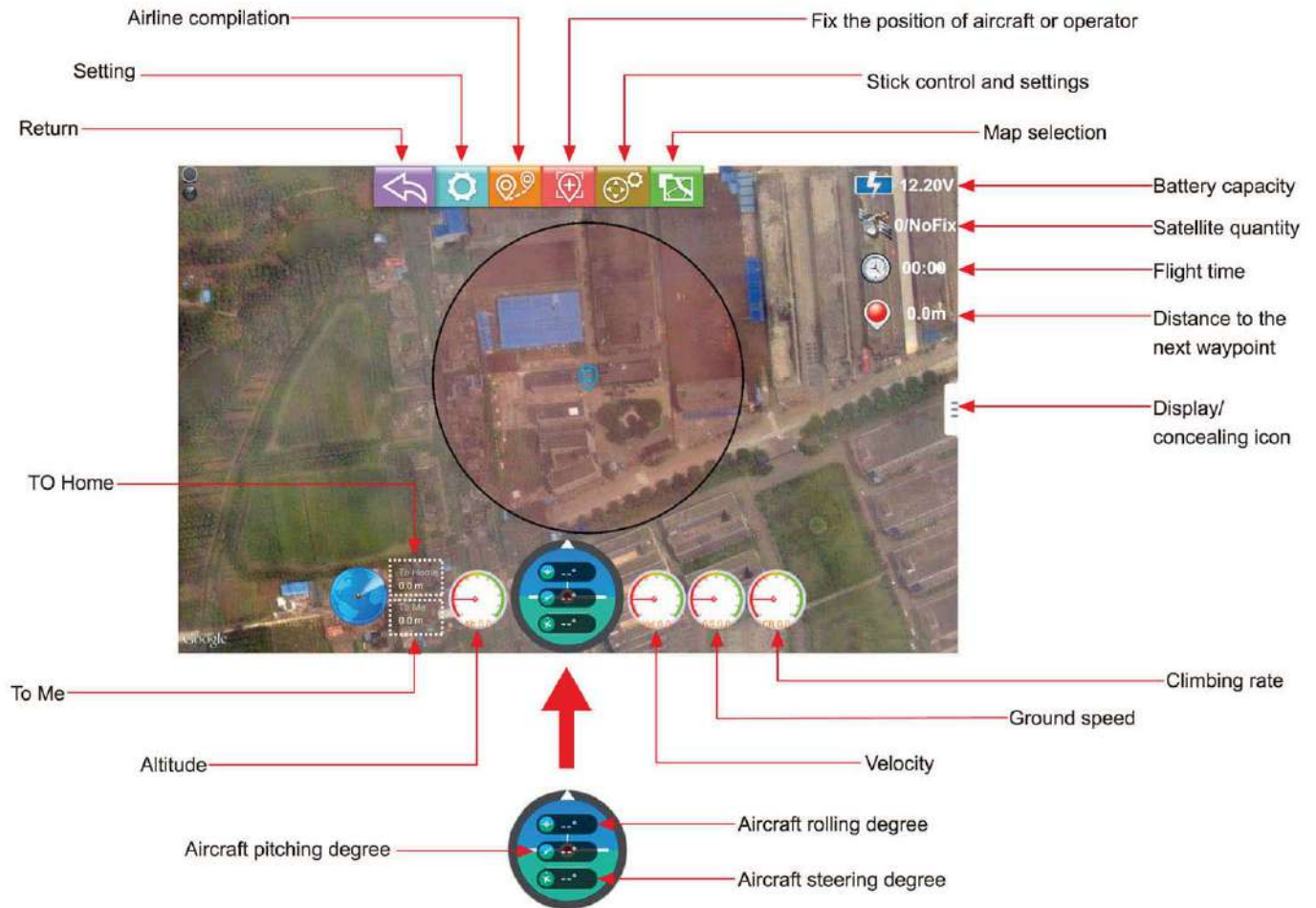

## 5.0 Main screen instructions



## 6.0 Airline compilation illustration

In the main screen, touch  icon and enter flight line edit screen. Touch icon  to save in the aircraft when finishing editing the flight line.

Position hold function: fix the position of aircraft or operator

Map selection

Airline recorded into aircraft

Readout airline from aircraft

Airline recorded into phone

Readout airline from mobile phone

Waypoint increase

Airline compilation

Waypoint decrease: Hold down the icon  to clear all waypoints





## 7.0 Compass Calibration

In the main screen, touch  icon then touch mode to enter stick control and setting screen.



**IMPORTANT:** Make sure the motors are locked before calibration (Aircraft red LED indicator is NOT flashing). Factory default setting, is for the motors to be locked after the completed ID binding process. (For details on motor lock and unlock process see point 10 and 11)



7.1 Touch the icon and enter compass calibration. The red LED of the aircraft will flash rapidly.



7.2 FORWARD rotation. Rotate tilting the aircraft forward rotate smoothly in 90 deg increments. Pausing 1 second for each 90 deg. (0 / 90 / 180 / 270 / 360)

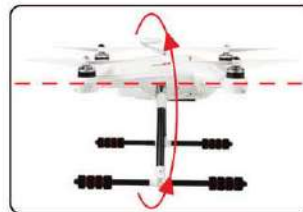

7.3 CLOCKWISE rotation. Rotate the aircraft around the roll axis rotate smoothly in 90 deg increments. Pausing 1 second for each 90 deg. (0 / 90 / 180 / 270 / 360)



7.4 HORIZONTAL rotation. Rotate the aircraft around the YAW axis rotate smoothly in 90 deg increments. Pausing 1 second for each 90 deg. (0 / 90 / 180 / 270 / 360)

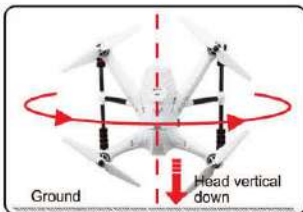

7.5 NOSE DOWN rotation. Rotate the aircraft facing the nose down. rotate smoothly in 90 deg increments. Pausing 1 second for each 90 deg. (0 / 90 / 180 / 270 / 360)



7.6 Put aircraft to the horizontal position, the red LED light out which means calibration finished. please reconnect the aircraft power after calibration.

- **IMPORTANT:** The first couple of flights, you may experience the aircraft drifting, This is normal, please continue to fly the aircraft manually, while the system improve the calibration, after 5-10 minutes land, lock the motors, this will save the improved settings.  
 Notice: The slight drifting may continue for a couple of batteries, you will notice significant improvement in the GPS hold & stability after 4-5 batteries.  
 Notice: Always perform the calibration away from electric fields and metal surfaces.  
 Trivia: Different brands have different calibration processes, the process is typically referred to as "the Calibration Dance".

## 8.0 G-3D 3-axis brushless Gimbal installation

**IMPORTANT:** REMOVE the battery from the Scout X4 while you install the gimbal

The gimbal is a high-performance electromechanical design and should be handled with great care. AVOID using force when installing.



8.1 Prepare the G-3D gimbal, M3x12 screw, spring.



8.2 Slide the gimbal onto the quik mount rail, the gimbal should slide from the front of the aircraft towards the rear, gently move it as far back as possible.



8.3 Install the springloaded M3x12mm "finger screw" at the front of the gimbal, this will secure the gimbal.



8.4 Connect the 9pin white data cable to the "complex data port" on the bottom of the X4, then connect the cable to the back of the G-3D gimbal.



8.5 Make sure the gimbal move freely in all directions. The G-3D gimbal is now successfully installed.

## 9.0 Installing the iLook+ 1080p camera with 5.8ghz video link



9.1 Screw the short "mushroom" antenna into the camera, use the included wrench to gently secure the antenna, do not use force.



9.2 Release the two M2x4 screws securing the camera mounting bracket.



9.3 Install the camera into gimbal, Fix it with camera fixed frame (ensure the gap close to the lens), then screw the M2x4 screw to the camera fixed frame again.

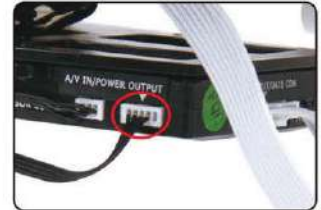

9.4 Connect the cameras power cable to the power port on the G-3D gimbal controller.



9.5 The iLook+ camera is now successfully installed in your G-3D gimbal.

## 10.0 Motor Unlock

After succeeding in binding the code, under the stable mode, put the throttle control ball in the lowest position, and stir the direction control ball to the far left. When the red LED indicator turn solid red, it means that the motor is unlocked. In this condition, if you turn upward the throttle control ball, the motor will run.

**Note:** For safety, the motors will automatically lock after 10 seconds. This means, if you do not start flying in 10 seconds, you have to unlock the motors again.

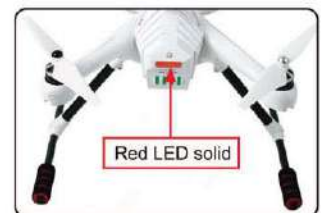
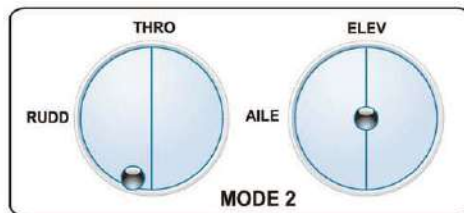
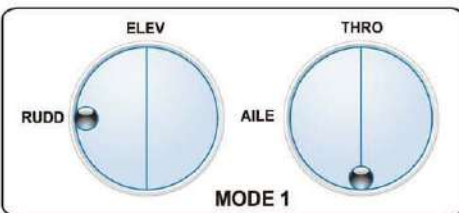

## 11.0 Motor Lock

Put the throttle control ball in the lowest position and stir the direction control ball to the far right. When the red LED indicator light out, it means that the motor is locked. In this condition, if you turn upward the throttle control ball, the motor will not run.

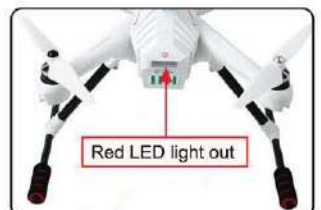
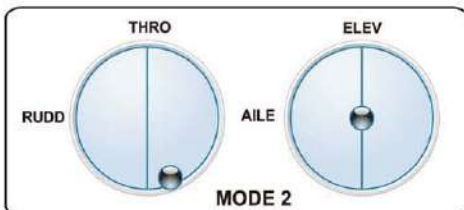
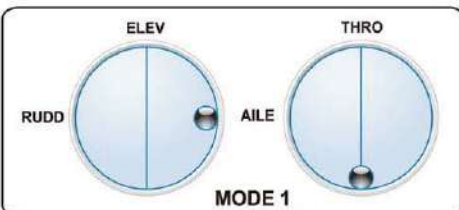



## 12.0 GPS indicator lights

GPS Satellites	<6	6	7	8	9	10	11	12	13
The blue LED status	No blinking	Blinking once	Blinking 2 times	Blinking 3 times	Blinking 4 times	Blinking 5 times	Blinking 6 times	Blinking 7 times	Blinking 8 times

**IMPORTANT: For SAFE flight in GPS flight mode:** the BLUE indicator light should at least "double" blink, (two blinks at a time)  
 It is highly recommended to wait for "triple blink" 8 satelites before starting the flight.  
**NEVER attempt to AUTO-START with less than "triple blinks"**

## 13.0 Function and rocker control interface description

In the main screen, touch  icon then touch mode to enter stick control and setting screen (picture 1).

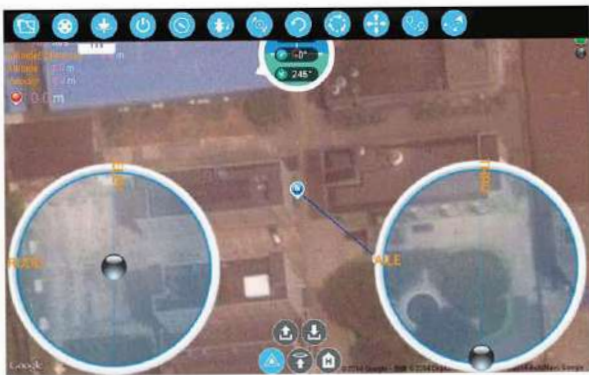

Hold (Picture 1) on the upper right corner screen edge and slide to left to enter, then will shows as below (picture 2)













Press the automatic cruise icon  to enter the editing interface of cruise.













Delete	Delete waypoint
Cruise	Cruise according to edit route
Store	Record to mobile phone
Write	Write into aircraft

Function	Icon	Instructions
<b>AUTO Take Off</b>		<p>Place aircraft on level ground → Unlock Motors → Touch icon → The aircraft could take off automatically</p> <p>Notes:                      You can use this function only when you can receive GPS signal and the GPS signal should be in good condition.</p>



Function	Icon	Instructions
Auto Landing		Touch icon → The aircraft could land automatically
Altitude hold mode		Touch icon → The aircraft could get into Altitude hold mode automatically Notes: (1) You can use this function only when you can receive GPS signal and the GPS signal should be in good condition. (2) If there is no GPS signal or the signal isn't in good condition, it will enter automatically altitude hold mode, instead of holding at one position.
One key Return To Home		Touch icon → The aircraft could get back to the origin automatically Notes: You can use this function only when you can receive GPS signal and the GPS signal should be in good condition.
Follow me mode		Touch icon → The aircraft could follow the location of mobile automatically After touching the screen, it will come out with a height setting dialog box, you can set the height and choose Normal or Fast on basic of your surrounding condition. Notes: You can use this function only when you can receive GPS signal and the GPS signal should be in good condition.
Automatic Cruise		Touch icon → The aircraft could cruise automatically After touching the screen, the aircraft will get into cruise control, and will cruise following the default route. Notes: You can use this function only when you can receive GPS signal and the GPS signal should be in good condition.
Backtracking		Touch icon → The aircraft could get back to the origin automatically. After touching the screen, the aircraft will get into cruise control, and will cruise following the default route to get back to the origin. Notes: (1) You can use this function only when you can receive GPS signal and the GPS signal should be in good condition. (2) Must touch the icon before aircraft arrive at the last waypoint to make it return back in same way.
Circle flight		Touch icon → The aircraft could circle flight automatically. Notes: You can use this function only when you can receive GPS signal and the GPS signal should be in good condition.
IOC mode		IOC means the aircraft flight direction only related to the position of the first GPS signals, unrelated to head direction of the aircraft. Notes: (1) You can use this function only when you can receive GPS signal and the GPS signal should be in good condition. (2) When you take the headless flight, you just need to press and hold back the control ball to make the aircraft fly back to the origin.
Single Waypoint flight		Touch icon → The aircraft will hover when arriving the flight point. Notes: You can use this function only when you can receive GPS signal and the GPS signal should be in good condition.
Waypoint record		Touch icon → The aircraft could record the flight points automatically. Notes: You can use this function only when you can receive GPS signal and the GPS signal should be in good condition.

Function	Icon	Instructions
Fence flight		Touch icon → Get into fence flight automatically After touching the icon, the aircraft could only fly within the set area. The aircraft will return automatically when reaching the edge Notes: You can use this function only when you can receive GPS signal and the GPS signal should be in good condition.
Skid landing folded		Click the icon to make the aircraft skid landing folded
Skid landing unfolded		Click the icon to make the aircraft skid landing unfolded.
Stable (normal) mode		Touch icon → The aircraft can be controlled manually or by gravity sensor.
Stick mode selection		There are 4 types of stick mode.
DATA Switch		Factory defaults are as "open".
Gravity Sensor		Factory defaults are as "open". The aircraft will be changed into manual control mode if you turn off the gravity sensor.
Map selection		Map selection
Return distance		Return distance
Control the gimbal tilting		
Control the gimbal rolling		



## 14.0 2.4G Bluetooth Datalink

The 2.4G Bluetooth Datalink consists of the Air end and the Ground end, which provides reliable and stable remote wireless transmissions for Ground Station based applications. The signal flow is as shown below.

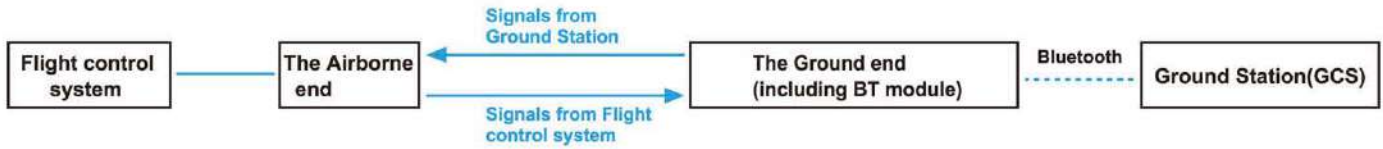

The airborne end: same usage as BT-2401A(FCC)/BT-2402A(CE), take BT-2402A(CE) as an example.

The ground end: same usage as BT-2401B(FCC)/BT-2402B(CE), take BT-2402B(CE) as an example.

### 14.1 Install antenna

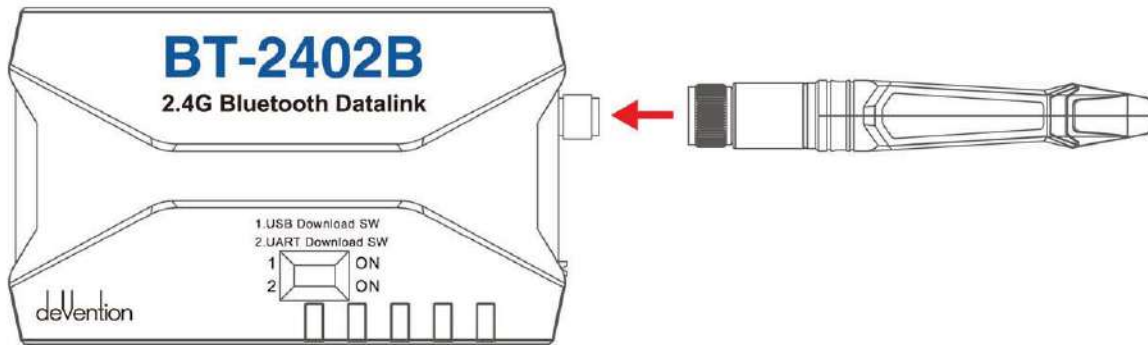

### 14.2 The cognition of BT-2402A(CE) the Air end

**Green light:** The reception by the Air end and the Ground end/ Transmit date indicator light (Green light)

**Blue light:** The reception by the Air end and the flight control end/ Transmit date indicator light (Blue light)

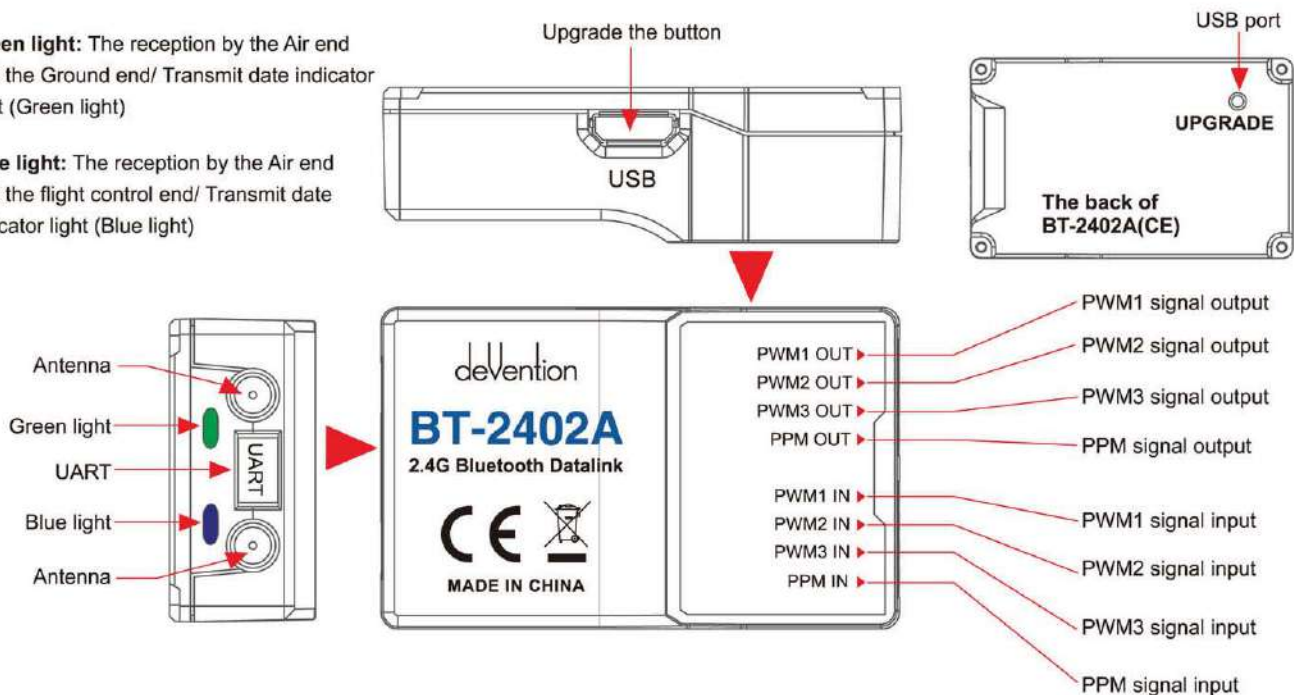

### 14.3 The cognition of BT-2402B(CE) the Ground end

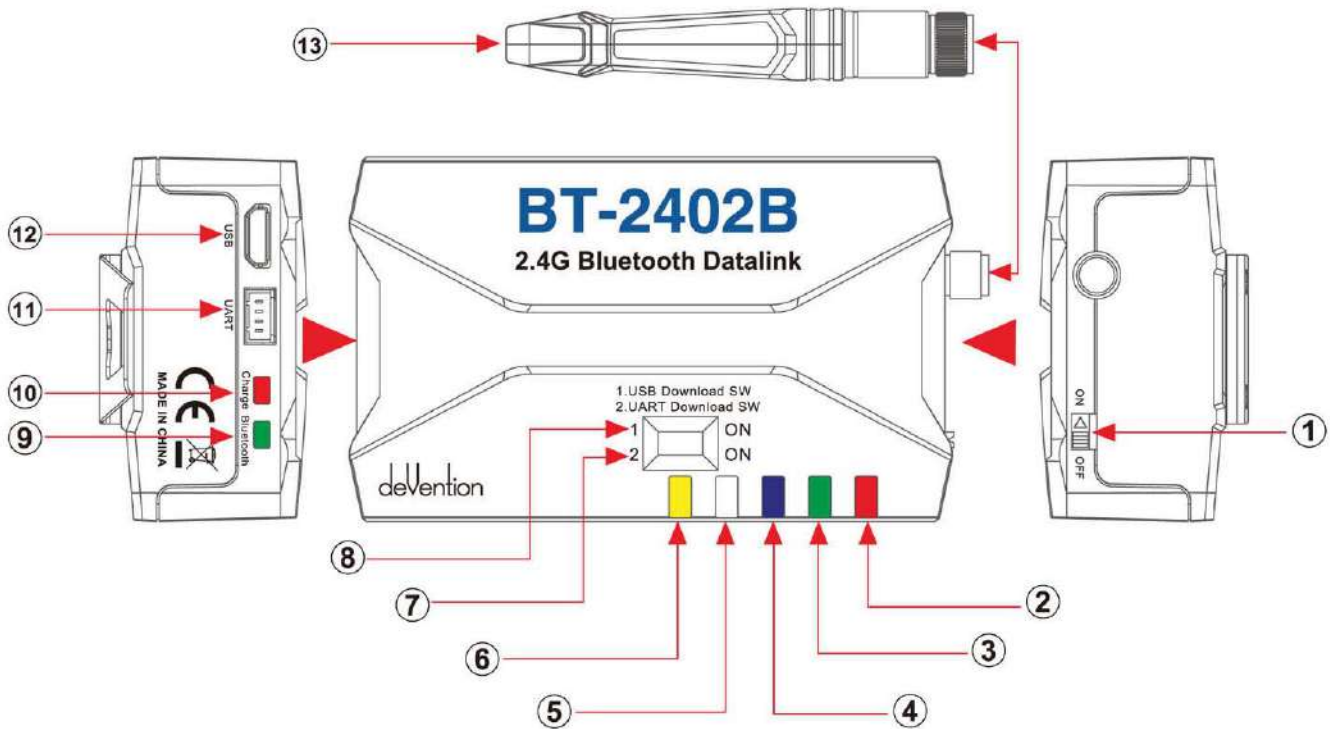

①	<b>ON-OFF:</b> Power switch
②	<b>Power LED:</b> Red light
③	<b>COM-TX LED:</b> The indicator (Green light) of the Ground end receive the data of ground station.
④	<b>COM-RX LED:</b> The indicator (Blue light) of the Ground end send data to ground station.
⑤	<b>RF-RX LED:</b> The indicator (White light) of the Ground end receive the data of flight control end.
⑥	<b>RF-TX LED:</b> The indicator (Yellow light) of the Ground end send data to flight control end.
⑦	<b>1 USB Download SW</b>
⑧	<b>2 UART Download SW</b>
⑨	<b>Bluetooth:</b> Bluetooth indicator light (Green light)
⑩	<b>Charge:</b> Charge indicator light (Red light)
⑪	<b>UART</b>
⑫	<b>USB:</b> USB port
⑬	<b>Antenna</b>



## 14.4 Connect illustration

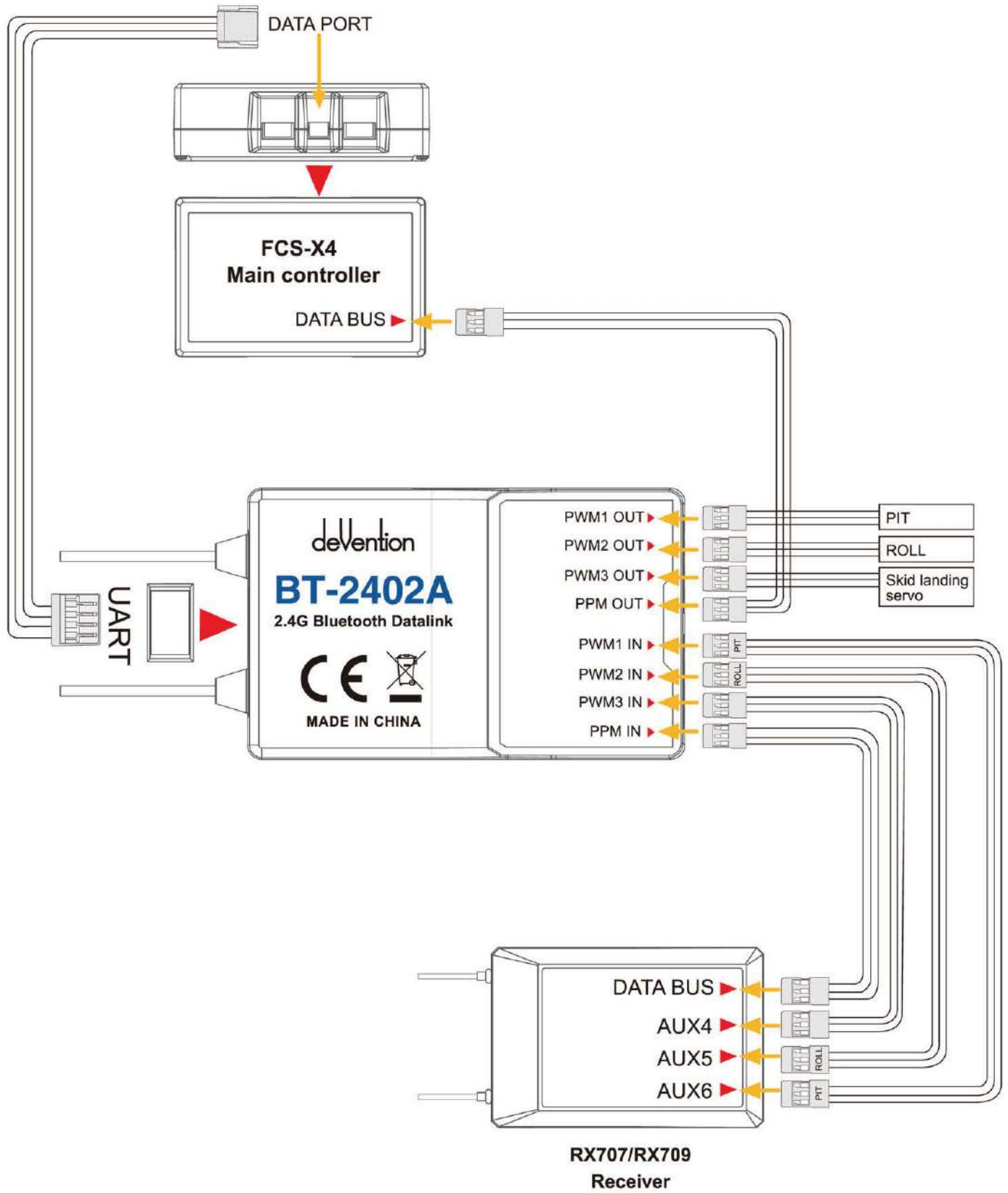

## 14.5 Program Upgrade

Both the Air end and the Ground end can be upgraded in Walkera official website. The tool for online upgrade: UP02 and the adaptor of UP02.

### 14.5.1 Upgrading for the Air end

(1) Please insert the blue, yellow, black color plug to the corresponding upgrading connection socket, then the other end of connection wire to the **UART port**.

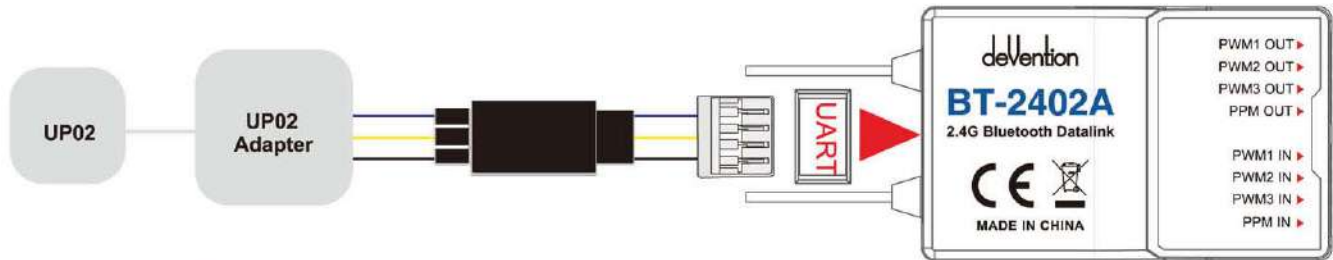

(2) Press button "UPGRADE" to supply power enter upgrading statue.

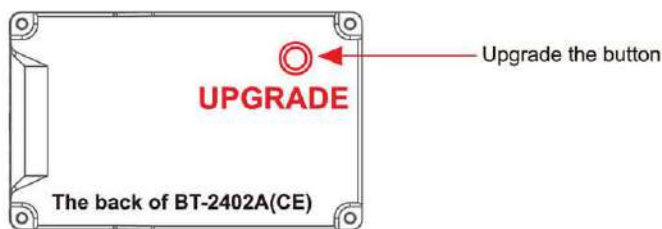

### 14.5.2 Upgrading for the Ground end

(1) Please insert the red, yellow, blue, black color flat cable to the **UART port**.

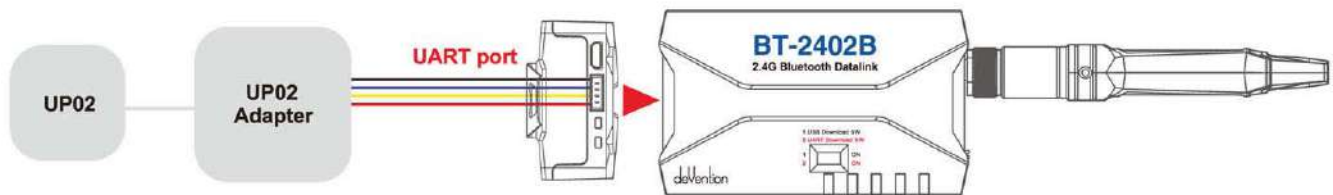

(2) Turn on the switch "2. UART Download SW" (position "ON")

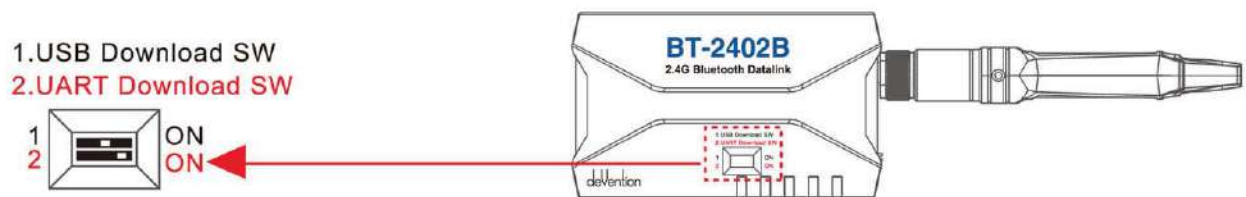

(3) Turn on the power switch enter upgrading status (position "on")

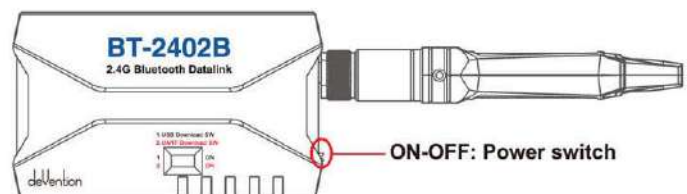



## 14.6 LED Indicator descriptions

	LED status	Status instructions
The Air end	Green LED flashes quickly	The Air end and Ground end is receiving/sending datas
	Green LED keeps solid	The Air end and Ground end is not receiving/sending datas
	Blue LED flashes quickly	The Air end and Flight control end is receiving/sending datas
	Blue LED keeps solid	The Air end and Flight control end is not receiving/sending datas
	Green and Blue LED flashes slowly	The Air end and Ground end lost signal
The Ground end	Red keeps solid of Power LED	Normal power voltage
	Red blinks of Power LED	Power voltage is less than 3.3V
	Green flashes quickly of COM-TX LED	The Ground end is receiving Ground Station datas
	Green keeps solid of COM-TX LED	The Ground end is not receiving Ground Station datas
	Blue flashes quickly of COM-RX LED	The Ground end is sending datas to Ground Station
	Blue keeps solid of COM-RX LED	The Ground end is not sending datas to Ground Station
	White flashes quickly of RF-RX LED	The Ground end is receiving Flight Control end datas
	White keeps solid of RF-RX LED	The Ground end is not receiving Flight Control end datas
	Yellow flashes quickly of RF-TX LED	The Ground end is sending datas to Flight Control end
	Yellow keeps solid of RF-TX LED	The Ground end is not sending datas to Flight Control end
	White and Yellow flashes slowly of RF	The Ground end lost contact with the Air end
	Green LED flashes quickly of Bluetooth	Bluebooth unconnect
	Green LED flashes slowly of Bluetooth	Bluebooth connected
	Red LED keeps solid of Charge	On charging
	Red LED out of Charge	Charge finished / normal situation

## 15.0 Ground station firmware setting

### 15.1 Channel setting

In the main screen, touch  icon and enter setting screen as shown below:



ELEV, AILE, THRO, RUDD fault setting is "NORMAL".

### 15.2 Parameter Setting



#### (1) FollowMe Height Set

Default height=10m

You can change the height by setting the datas(5-200m).

#### (2) One Key Takeoff

Default height=10m

You can change the height by setting the datas(5-15m).

#### (3) Waypoint Default Altitude

Default height=15m

You can change the height by setting the datas(5-400m).

### 15.3 Accelerometer Calibration

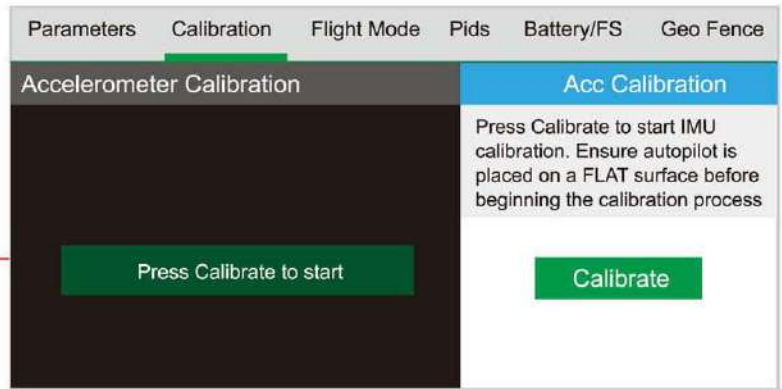
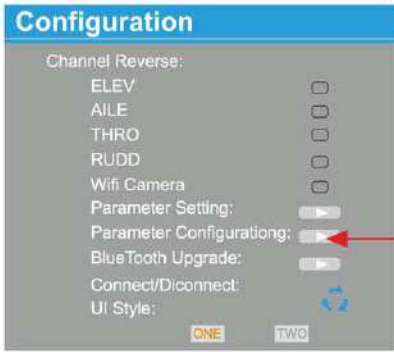

### 15.4 Battery voltage point

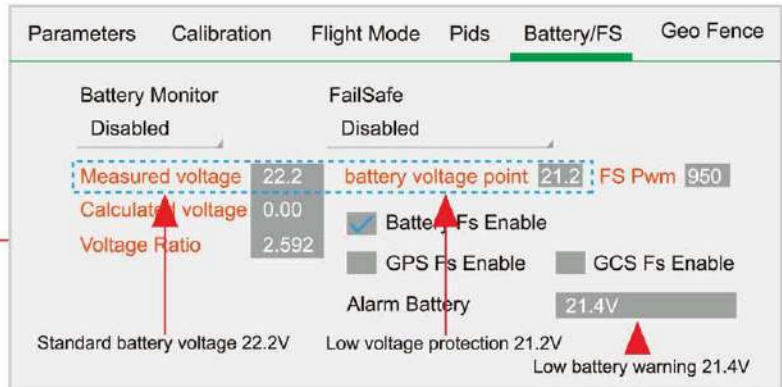

### 15.5 Geo Fence

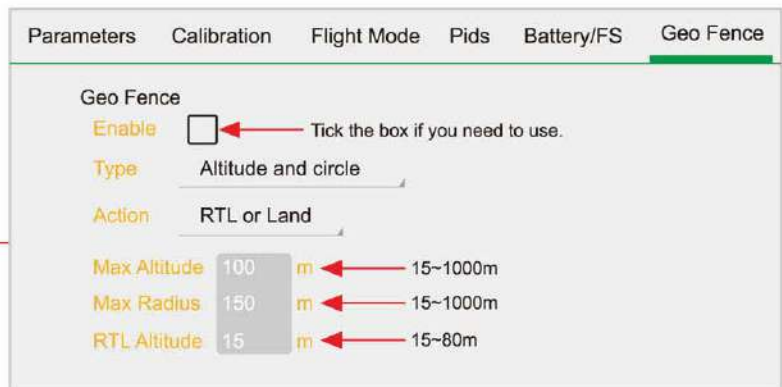



## 15.6 BlueTooth Upgrade

### 15.6.1 BT-2401B/BT2402B Ground end upgrading

(2) Turn on the switch "2. UART Download SW" (position "ON")

- 1. USB Download SW
- 2. UART Download SW

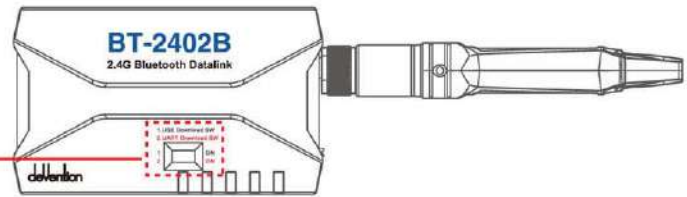

(2) Connect the Ground end BT-2401B/BT-2402B to Ground Station software GCS and entering into the upgrade interface.

(3) Choose the correct Ground end file to upgrade

### 15.6.2 BT-2401A/BT2402A Air end upgrading

(1) Turn on the switches of "1. USB Download SW" and "2. UART Download SW" (To "ON")

- 1. USB Download SW
- 2. UART Download SW

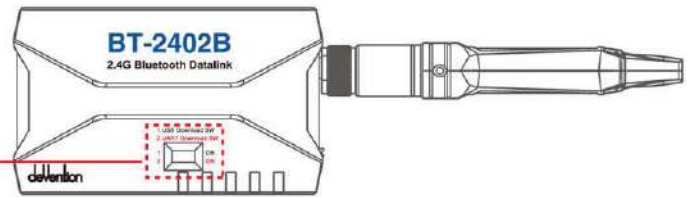

(2) Connect the air end BT-2401B/BT2402B to Ground station software GCS and enter into the upgrade interface

(3) Connect both Air end BT-2401A/BT2402A and Ground end BT-2401B/2402B.

(4) Choose the correct air end file to upgrade

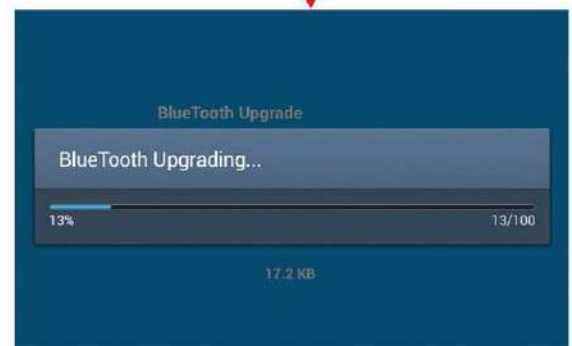
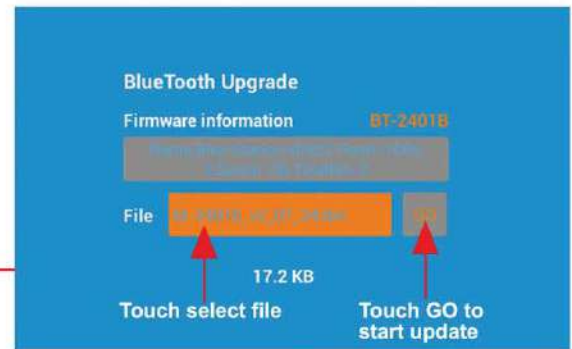
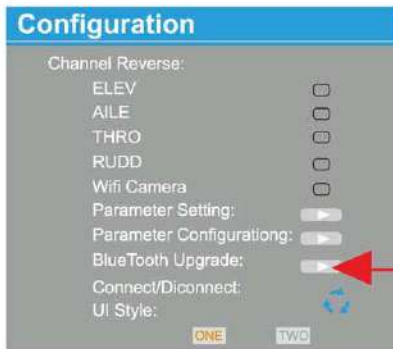

**Tips:** Please reconnect and upgrade again if the upgrading can't be finished and succeed in one minute.

## 16.0 FCS-X4 Main controller guideline

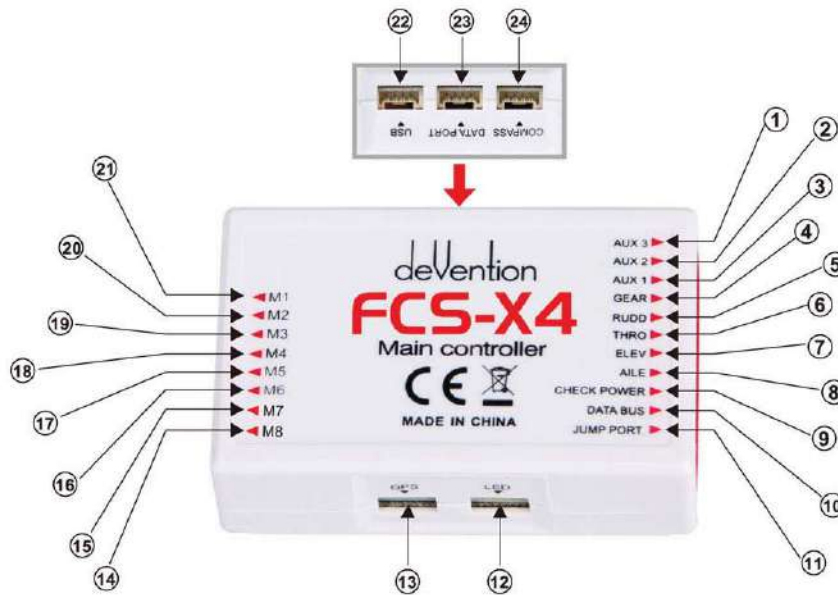

①	To roundly cruise flight mode	⑨	To check voltage(connect with power board)	⑰	Connect with fifth way brushless ESC
②	To hyper IOC	⑩	Used for data transmission-connect the PPM OUT port of BT-2401A/2402A	⑱	Connect with forth way brushless ESC
③	To one key to take off	⑪	Jumper port, when regular receiver is need, insert random equipped bind plug pls.	⑲	Connect with third way brushless ESC
④	Control Mode Switch	⑫	To link LED	⑳	Connect with second way brushless ESC
⑤	To control Rudder	⑬	To link GPS module(red white blue black four color cable)	㉑	Connect with first way brushless ESC
⑥	To control Throttle	⑭	Connect with eighth way brushless ESC	㉒	Upgrade channel
⑦	To control Elevator (forward & backward)	⑮	Connect with seventh way brushless ESC	㉓	Data communcation port
⑧	To control Aileron (leftward & rightward)	⑯	Connect with sixth way brushless ESC	㉔	To link Compass (red black double color cable)

## 17.0 DEVO RX707/RX709 Receiver guideling

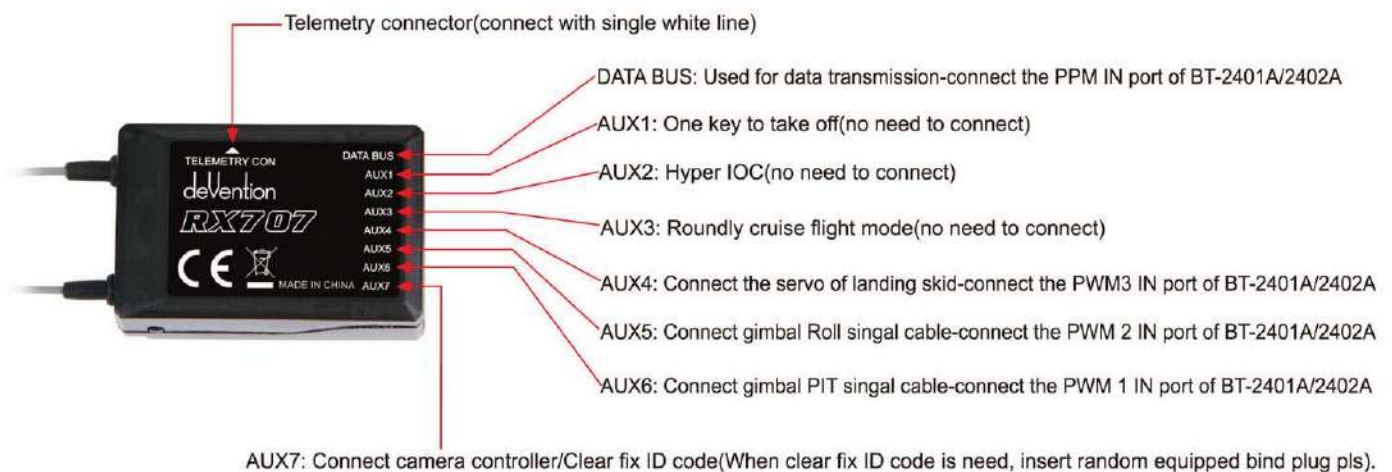

**Attention: DEVO RX707(CE) and DEVO RX709(FCC)have the same ports.**

Tel.: (8620) 8491 5115 8491 5116

Fax.: (8620) 8491 5117

Email: [heli@walkera.com](mailto:heli@walkera.com)  
[info@walkera.com](mailto:info@walkera.com)

Add.: Taishi Industrial Park, Dongchong Town  
nansha District, 511475 Guangzhou

USA Warehouse: [iUASinc.com](http://iUASinc.com)

deVention

Specifications, contents of parts and availability  
are subject to change, Walkera is not responsible  
for inadvertent errors  
in this publication.



Web: [www.walkera.com](http://www.walkera.com)