

ScoutX4

devention

- Auto Take off
- Object Round fly mode
- Hyper IOC mode
- GPS telemetry
- Altitude hold mode
- One key Return To Home
- Retractable Landing Gear
- 5.8G video down link

Match with **DEVO F12E Radio**

Quick Start Guide and Systems Flowchart

● Specifications:

Main Rotor Dia. : 233mm

Overall (L x W x H): 335 x 335 x 275mm

Weight: 1770g(Battery included)

Takeoff Weight: <2270g

Transmitter: DEVO F12E

Receiver: DEVO-RX707(CE) / RX709(FCC)

Brushless Motor: WK-WS-34-002

Brushless ESC: WST-16AH (R/G)

Main Controller: FCS-X4

Battery: 22.2V 5400mAh Li-Po

Ground Station: GCS

2.4G Bluetooth Datalink: BT-2401A(FCC) / 2401B(FCC)
BT-2402A(CE) / 2402B(CE)



- M1/M3 rotate in clockwise, motors are the levogyrate thread.
- M2/M4 rotate in counterclockwise, motors are the dextrogyrate thread.
- When assemble the propellers, rotating direction is oppsite to the arrow direction, the directions are the same when take down the propellers.

1.0 Installing the Propellers

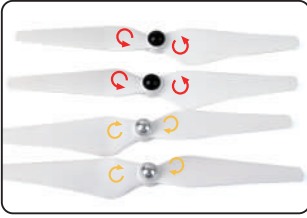

1.1 Prepare forward propeller (Clockwise arrow mark), counter propeller (counterclockwise arrow mark)



1.2 Match the arrows on the propellers to the arrows on the arm next to each motor. Screw each propeller onto the motor, secure by hand, no need for tools.



1.3 Propellers assembled (assembled skid landing)



1.4 Propellers assembled (unassembled skid landing)

2.0 Restore or assemble the skid landing/binding the radio

2.1 Skid landing assembled(restoration/code binding)

The Landing gear is shipped in the retracted position. **DO NOT** try to extend the landing gear by pulling on it. We will deploy the landing-gear the first time the system is powered, please follow these instructions carefully.



2.1.1 Install the fully charged battery DO NOT turn on the battery until later.
*Please check the charger manual for charging instructions



2.1.2 Turn X4 on its back. The belly and the retractable legs should now be facing up. MAKE SURE nothing is blocking the legs.



2.1.3 Put all function switches to 0 position, put all trims/knobs on Mid position, move the throttle to the lowest position, then turn on the radio power.

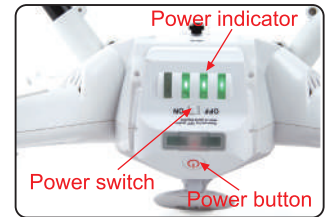

2.1.4 Turn the power switch to "ON" position, and press on the power button about 3-5 second till the red LED light solid. The undercarriage(skid landing) will unfold automatically.



2.1.5 Turn the aircraft to its UP-right position. The Red LED flashing will stop shortly. When it stops, the DEVO F12E and the X4 have successfully connected to each other.
* This process is called "ID binding"



2.1.6 After the successful binding place the aircraft on a stable surface.

2.2 Skid landing unassembled(assemble skid landing/code binding)

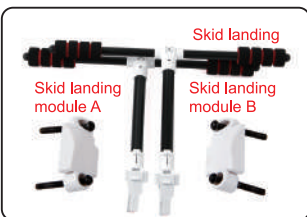

2.2.1 Prepare two skid landing, skid landing module A/B, 4pcs M2.5X20 screws.



2.2.2 Put the skid landing into the skid landing position.

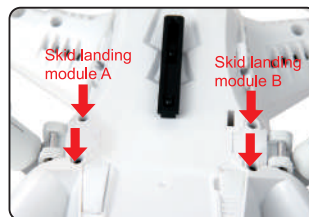

2.2.3 Install the skid landing module, and screw down the M2.5X20 screw to fix skid landing.



2.2.4 Skid landing installation finished.



2.2.5 Put all function switches to 0 position, put all trims/knobs on Mid position, move the throttle to the lowest position, then turn on the radio power.

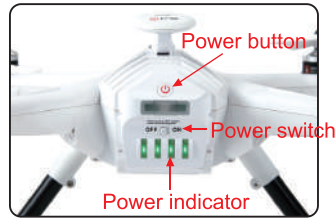

2.2.6 Put the aircraft on the horizontal position, slide the power-switch to the ON position, then press on the power button for about 3-5 seconds, until the green power indicator lights up.



2.2.7 Red LED flashing till to go out means the code binding finished.

3.0 Compass Calibration

IMPORTANT: Make sure all TRIMs are in the center position, the trim value should be "0", and that the motors are locked. The aircraft should NOT be flashing RED. By default, the motors will automatically be locked after the ID binding process. For more details about locking and unlocking motors, see points 6 & 7.



3.1 Enter the calibration mode Do this by moving both sticks DOWN and to the middle position at the same time. The aircraft will start a blinking fast RED.

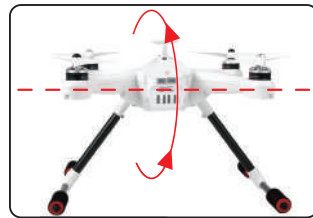

3.2 FORWARD rotation. Rotate tilting the aircraft forward rotate smoothly in 90 deg increments. Pausing 1 second for each 90 deg. (0 / 90 / 180 / 270 / 360)

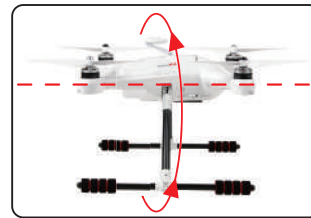

3.3 CLOCKWISE rotation. Rotate the aircraft around the roll axis rotate smoothly in 90 deg increments. Pausing 1 second for each 90 deg. (0 / 90 / 180 / 270 / 360)

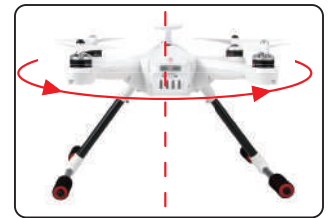

3.4 HORIZONTAL rotation. Rotate the aircraft around the YAW axis rotate smoothly in 90 deg increments. Pausing 1 second for each 90 deg. (0 / 90 / 180 / 270 / 360)

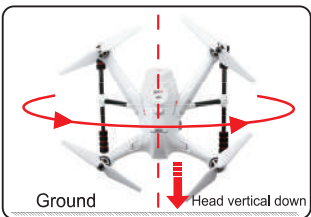

3.5 NOSE DOWN rotation. Rotate the aircraft facing the nose down. rotate smoothly in 90 deg increments. Pausing 1 second for each 90 deg. (0 / 90 / 180 / 270 / 360)



3.6 Place the aircraft in normal position The rapid RED blinking will stop This indicate that the calibration is finished Disconnect the battery to save the settings.

IMPORTANT: The first couple of flights, you may experience the aircraft drifting,

This is normal, please continue to fly the aircraft manually, while the system improve the calibration, after 5-10 minutes land, lock the motors, this will save the improved settings.

Notice: The slight drifting may continue for a couple of batteries, you will notice significant improvement in the GPS hold & stability after 4-5 batteries.

Notice: Always perform the calibration away from electric fields and metal surfaces.

Trivia: Different brands have different calibration processes, the process is typically referred to as "the Calibration Dance".

4.0 G-3D 3-axis brushless Gimbal installation

IMPORTANT: REMOVE the battery from the X4 while you install the gimbal

The gimbal is a high-performance electromechanical design and should be handled with great care. AVOID using force when installing.



4.1 Prepare the G-3D gimbal, M3x12 screw, spring.



4.2 Slide the gimbal onto the quick mount rail, the gimbal should slide from the front of the aircraft towards the rear, gently move it as far back as possible.



4.3 Install the springloaded M3x12mm "finger screw" at the front of the gimbal, this will secure the gimbal.



4.4 Connect the 9pin white data cable to the "complex data port" on the bottom of the X4, then connect the cable to the back of the G-3D gimbal.

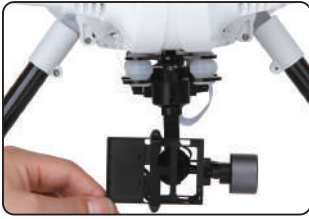

4.5 Make sure the gimbal move freely in all directions.
The G-3D gimbal is now successfully installed.

5.0 Installing the iLook+ 1080p camera with 5.8ghz video link



5.1 Screw the short "mushroom" antenna into the camera, use the included wrench to gently secure the antenna, do not use force.



5.2 Release the two M2x4 screws securing the camera mounting bracket.



5.3 Install the camera into gimbal, Fix it with camera fixed frame (ensure the gap close to the lens), then screw the M2x4 screw to the camera fixed frame again.

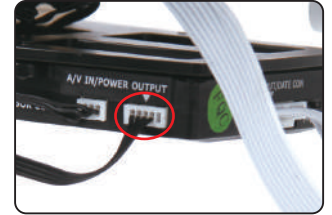

5.4 Connect the cameras power cable to the power port on the G-3D gimbal controller.



5.5 The iLook+ camera is now successfully installed in your G-3D gimbal.

6.0 Motor Unlock

After binding the DEVO F12E to the X4, Check that all trims are neutral, the throttle stick ALL the way DOWN. the display should say 0% throttle
Check that ALL switches are in the UP position.

You can not start the motors in the GPS hold mode.

Gently push the throttle stick down and move the rudder (YAW) stick to the left side. (on mode 2 radios throttle and rudder is the same stick)

You will see the RED indicator LED's will turn on, this indicate the motors are unlocked,

Be very careful at this point, as pushing the thottle up will start the motors.

You can test by pushing the stick up a little, the motors should start. For your safety, the motors will dis-arm again after 10seconds.



Mode 1(throttle stick on the right)



Mode 2(throttle stick on the left)

7.0 Motor Lock

Lock the motors by moving the throttle stick all the way down and the rudder (YAW) stick all the way to the right.

The RED LED light will go out when the motors are disarmed.

TEST: push the throttle stick up a little, the motors will not start when locked.

NOTICE:

* The motors are LOCKED by default after successful binding.

* Motors can NOT be unlocked or locked in GPS-hold mode.

if you land in GPS mode, move the "MIX" switch to position "0" before locking the motors, make sure you wait until the X4 is safely on the ground before changing the switch to "0" (manual) While changing, make sure to keep the throttle DOWN to prevent motors start.



Mode 1(throttle stick on the right)



Mode 2(throttle stick on the left)

8.0 DEVO F12E- quick guide to control functions

Mode 2 (Throttle stick on the left)	Left stick	THRO/RUDD stick
	Right stick	ELEV/AILE stick
	Left trim	THRO trim
	Right trim	ELEV trim
Mode 1 (Throttle stick on the right)	Left stick	ELEV/RUDD stick
	Right stick	THRO/AILE stick
	Left trim	ELEV trim
	Right trim	THRO trim

(0) Manual Mode	(1) GPS-hold Mode	(2) Return TO Home
MIX Switch to "0"	MIX Switch to "1"	MIX Switch to "2"

You NEED to memorize these settings



9.0 GPS indicator lights





















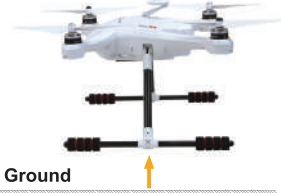

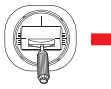
GPS Satellites	<6	6	7	8	9	10	11	12	13
The blue LED status	No blinking	Blinking once	Blinking 2 times	Blinking 3 times	Blinking 4 times	Blinking 5 times	Blinking 6 times	Blinking 7 times	Blinking 8 times

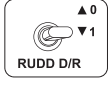
IMPORTANT: For SAFE flight in GPS flight mode: the BLUE indicator light should at least "double" blink, (two blinks at a time)

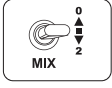
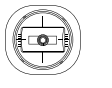
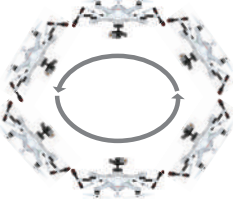
It is highly recommended to wait for "triple blink" 8 statelites before starting the flight.

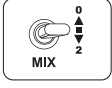
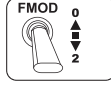
NEVER attempt to AUTO-START with less than "triple blinks"

10.0 Operation Instruction

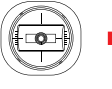
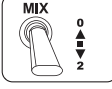
Model (← is the nose direction)	Mode 1	Mode 2
THROTTLE Up/down 		
PITCH Forward/backward Scout X4 nose move up/down 		
ROLL (lean) Left / right 		
YAW (turn) Left / right 		
AUTO Take Off You should have triple blink = 8sats for this feature. ARM/UNLOCK motors in manual mode 		   
GPS hold mode You can fly in this mode simply move the controls when you let go of the control, the Scout X4 will stop NOTE: You must CENTER the throttle stick for altitude hold 		  <p>DO NOT switch to manual before landing it is safer to land in GPS hold mode. switch to manual AFTER landing to lock motors</p>
ROUND FLY mode This mode is used for making circles around a object of interest. RADIUS is set in the F12E menu by adjusting Position 2 value for AUX3 		   <p>MIX switch to "1" position Move FMOD switch to "2" The Round Fly will start Move FMOD switch to "0" The Round Fly will stop</p>
RETURN TO HOME Activating this feature will casue the Scout X4 to climb to 15m at this height it will fly to the starting location and proceed to land. 		  <p>You can stop RTH by switching to GPS hold MAKE SURE the throttle stick is set to 50% when switching. NEVER switch to MANUAL from RTH, this can cause a crash.</p>

11.0 DEVO F12E Radio function setup and operation instructions

Function	Switch	Transmitter setting	Instructions
AUTO Take Off	RUDD D/R	Model Menu ↓ Device Output ↓ Flap ↓ RUDD D/R ↓ Active	Place aircraft on level ground → Unlock Motors → Move throttle stick to lowest position → Set MIX switch to "0" Position → Set RUDD D/R switch to "1" Position IMPORTANT: ONLY use this function with BLUE TRIPLE blink = 8 or more satellites, AUTO take off with less satellites may result in a crash. AFTER completing auto-take-off, you can take control by moving the throttle stick to 50%, then flip the RUDD D/R switch to "0" position.
GPS hold mode	MIX SW	Model Menu ↓ Device Output ↓ Gear ↓ MIX SW ↓ Active	"0" position: Manual mode "1" position: GPS hold mode "2" position: Return To Home MIX switch to "1" position → Throttle stick return neutral NEVER use this mode with less than 8 satellites locked, you should see BLUE TRIPLE BLINK. Before switching mode, always put the throttle stick to middle position (50%). IF the GPS signal degrades, the X4 will automatically enter "Altitude hold mode" note in this mode it will drift, but will hold its altitude. After flying 50% of the battery, do NOT switch from GPS mode to Manual, this may cause a sudden drop / crash. You can land in GPS mode, after landing, keep the throttle stick DOWN and switch to manual, then lock the motors.
Round Fly Mode	FMOD	Model Menu ↓ Device Output ↓ AUX3 ↓ FMOD SW ↓ Active	"0" Position: OFF "1" Position: Not in use "2" Position: activate Round Fly This mode require 8 satellites locked, you should see BLUE TRIPLE BLINK. Before activating the round-fly mode, you should be in "GPS hold mode" always put the throttle stick to middle position (50%) The default roundfly radius is 5 meters (15 feet), You can change the Round Fly radius by editing the AUX 3 EPA (End Point Adjustment) on the F12E transmitter, for details on editing EPA settings, see the F12E instruction manual. After having changed the setting, you should turn FMOD switch to "0" position to save the data, then return to "2" position to read the new Roundly radius.
Return TO Home	MIX SW	Model Menu ↓ Device Output ↓ Gear ↓ MIX SW ↓ Active	"0" position: Manual mode "1" position: GPS hold mode "2" position: Return To Home Throttle stick return neutral → MIX switch to "2" position The Return To Home mode, only work when you have a solid GPS lock, it is recommend to avoid flying if GPS lock is missing. After engaging Return to Home mode, lave the throttle stick at 50% (centered) do not touch any switches on the F12E radio. You can REGAIN control of the Scout X4, make sure the throttle is centered, then flip the MIX switch to "1" position. in a emergency like loss of control link between the F12e and the Scout X4, the Failsafe system will automatically start RTH, you may not be able to interupt a emergency RTH, simply let the aircraft continue until it lands.

Function	Switch	Transmitter setting	Instructions
Hyper IOC Mode	ELEV D/R	Model Menu ↓ Device Output ↓ AUX2 ↓ ELEV D/R ↓ Active	 <p>IOC or Intelligent Orientation Control mode Means the aircraft's flight direction is only relative to the original take-off point (where you armed the motors). REGARDLESS of the actual aircraft heading, with this mode you can fly past something and pan the aircraft to frame your shot, without having to worry what direction the aircraft is facing.</p> <p>ELEV D/R switch "0" position: IOC OFF "1" position: IOC ON</p> <p>The IOC mode require a strong GPS lock, you should have triple blinks on the blue GPS indicator light.</p> <p>IOC is inactive if the Scout X4 is less than 10 meter (30 feet) from the original take-off position. (point where you armed the motors)</p> <p>Fly the Scout X4 manually to past 10 meters using the GPS mode, activate the IOC mode when you are past 10meters, the Scout X4 will now fly IOC until you change mode, you can pan freely for video shots, when you push the stick right or left, the Scout X4 will move sideways relative to the original take-off position. Pushing the pitch stick up will push the Scout X4 away from you, pulling the stick back, bring the Scout X4 back to the starting point. When flying in IOC mode, you can make the Scout X4 return home by simply pulling the PITCH stick down.</p> <p>WARNING: The IOC turns off when the aircraft get closer than 10meters to the take off point, be prepared for this, as the system will switch back to GPS hold mode at that point. this switch can cause confusion if the pilot are not prepared.</p>
Extend/Retract of Landing Gear	GEAR	Model Menu ↓ Device Output ↓ AUX4 ↓ GEAR SW ↓ Active	<p>"0" Position: Extend landing Gear</p> <p>"1" Position: Retract landing Gear</p> <p>NOTE: REMEMBER your landing gear, it is easy to forget the landing-gear when flying FPV. its not a good idea to land on your camera. When activating the RTH (Return To Home) system, either by the pilot or by the failsafe system.</p> <p>The Scout X4 will automatically extend the landing gear to protect your camera and make sure the Scout X4 land safely.</p> <p>You can not change the landing gear after the Scout X4 have automatically extended for landing. you must land and lock / unlock motors.</p>

12.0 DEVO F12E Radio Setting

12.1 Boot Screen(Main interface)

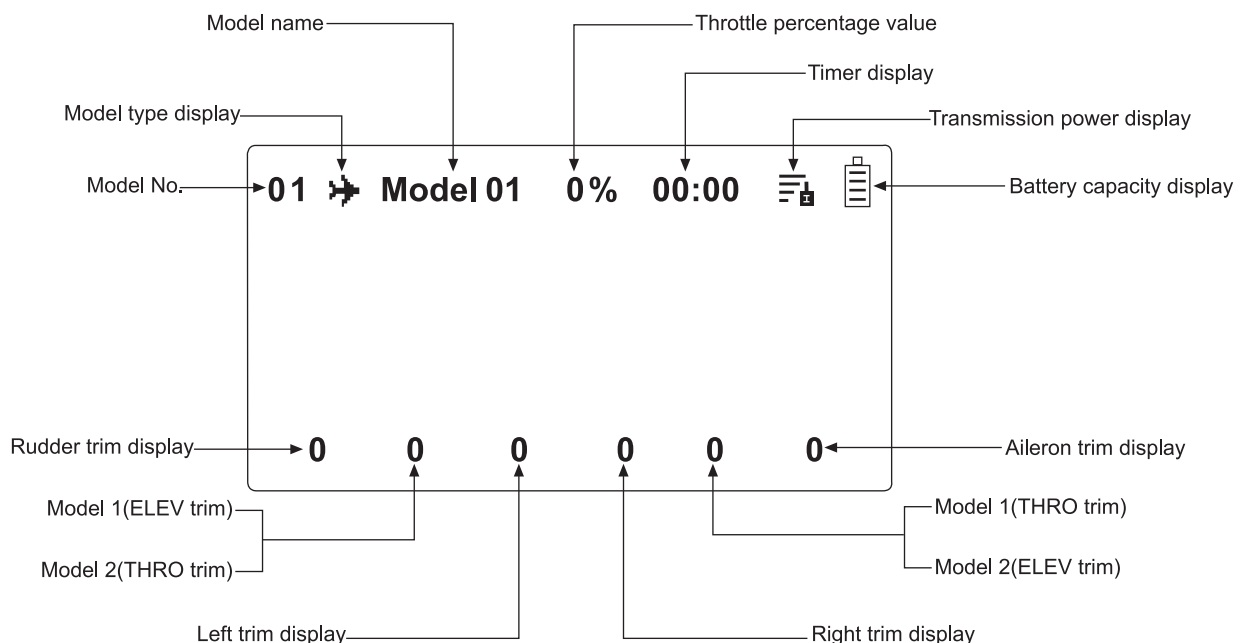

12.2 Model Select

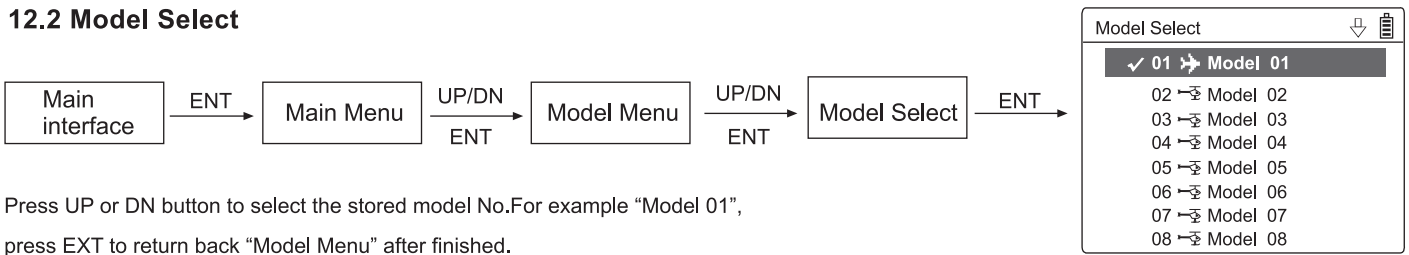

12.3 Model Name

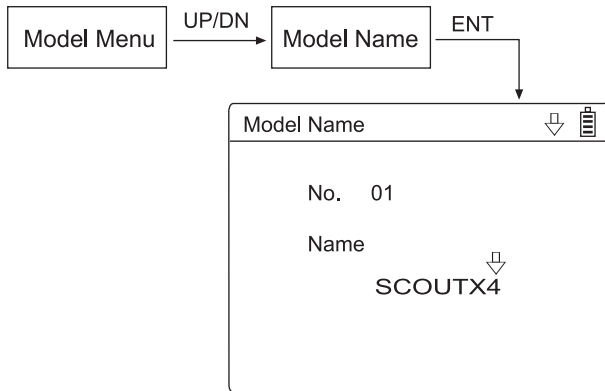

12.4 Type Select

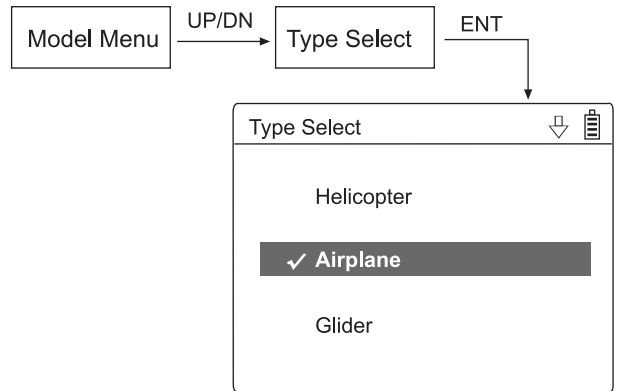

12.5 Wing Type

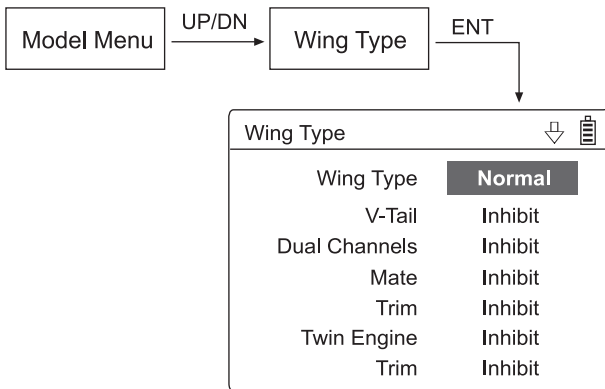

12.6 Device Output

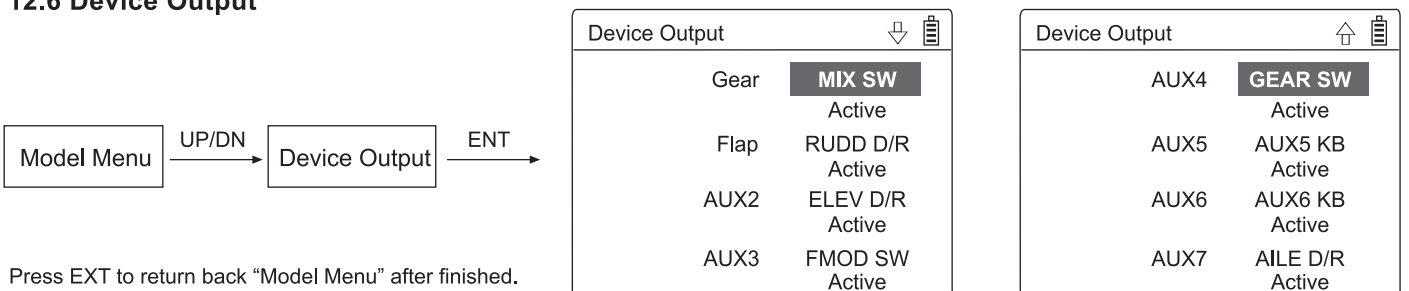

12.7 Sensor Setting

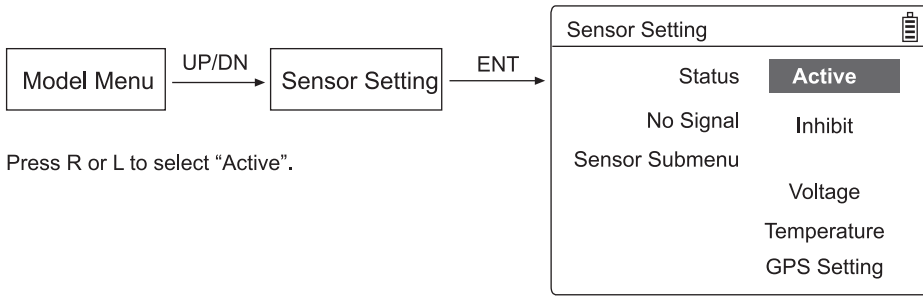

Press R or L to select "Active".

(1) Voltage Setting

Press UP or DN to select Voltage in the Sensor Setting. Press ENT to enter Voltage interface.

Voltage	
Internal: V0	Inhibit
External: V1	Active
	21.4V
External: V2	Inhibit

Internal shows the Radio battery voltage.

External shows the aircraft battery voltage.

Scout X4 default setting is 21.4V, please fly back the copter when you get a warning asap.

(2) GPS Receive Setting

Press UP or DN to select GPS setting on the Sensor Setting interface, then press ENT to enter GPS Setting interface.

GPS Setting	
Altitude Type	Relative
Speed Unit	Km/h
Date Type	DD-MM-YY
Time Zone	UTC+08:00

(2.1) Altitude Type setting:

Press R or L to select Absolute or Relative.

(2.2) Speed Unit setting:

Press R or L to select Km/h or Knot.

(2.3) Date Type setting:

Press R or L to select DD-MM-YY\ MM-DD-YY\ YY-MM-DD.

(2.4) Time Zone:

Press R or L to select Time Zone, then press EXT to return "Main Menu".

12.8 Reverse Switch

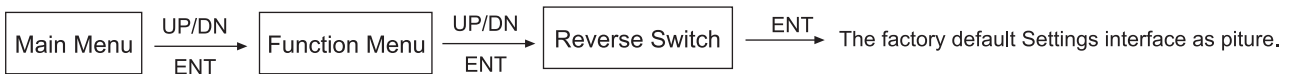

Reverse Switch	
Elevator	Normal
Aileron	Normal
Throttle	Normal
Rudder	Normal
Gear	Normal
Flap	Normal
AUX2	Normal
AUX3	Normal

Reverse Switch	
AUX4	Normal
AUX5	Normal
AUX6	Normal
AUX7	Normal

Press EXT to return back "Function Menu" after finished.

12.9 Servo Travel Adjust

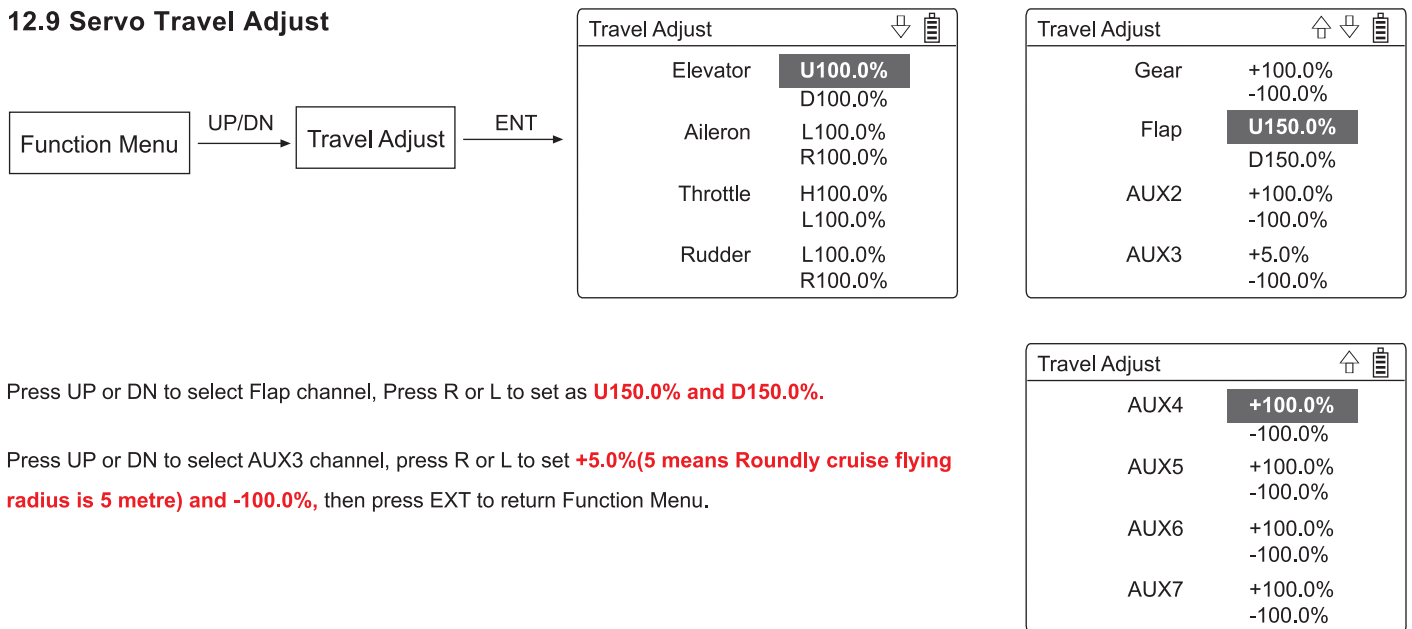

Press UP or DN to select Flap channel, Press R or L to set as **U150.0% and D150.0%**.

Press UP or DN to select AUX3 channel, press R or L to set **+5.0%(5 means Roundly cruise flying radius is 5 metre) and -100.0%**, then press EXT to return Function Menu.

12.10 Senser View

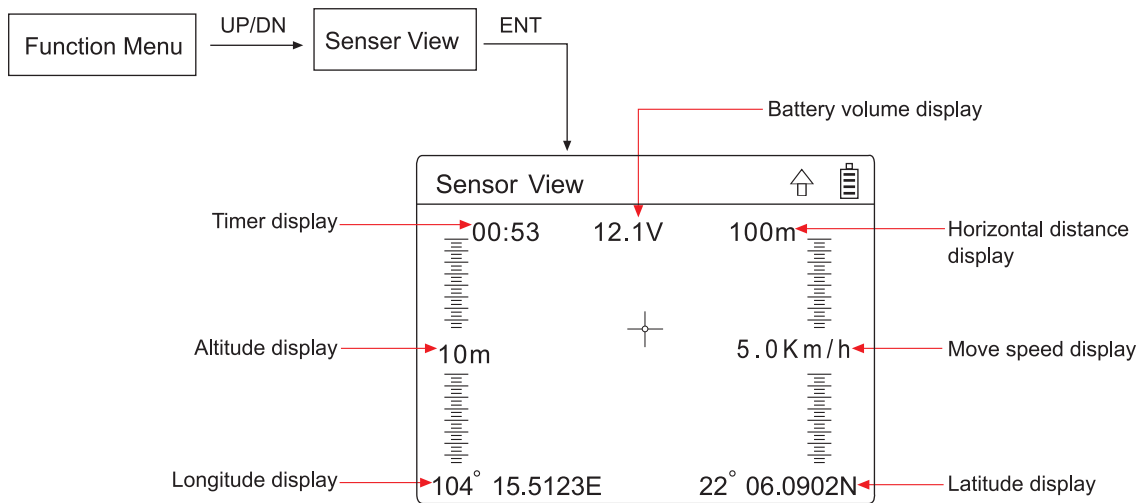

Press R or L to select viewport display. When set the image as background, Information will be displayed on the image.

12.11 Video Setting

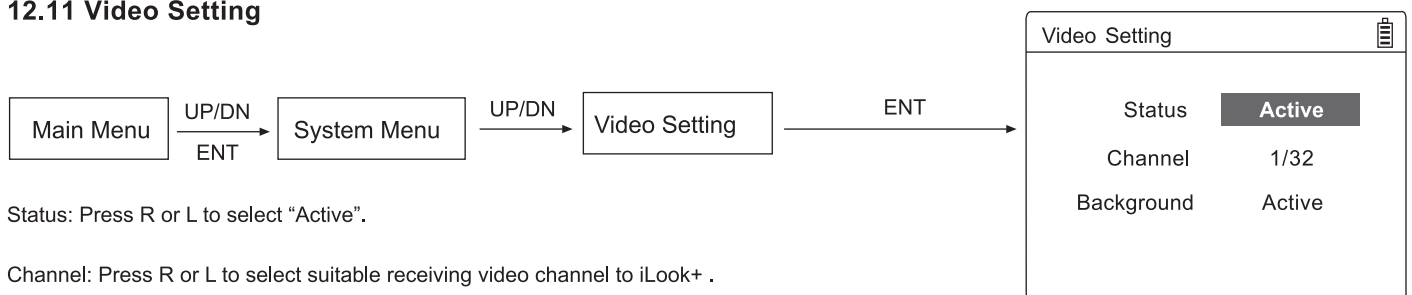

Status: Press R or L to select "Active".

Channel: Press R or L to select suitable receiving video channel to iLook+ .

Background: Press R or L to select Active, Real-time image could be set as background in Main Menu.

Press EXT to show full screen image in Main Menu.

12.12 Timer Setting

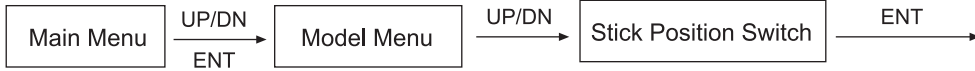

Stick Position Switch ☰

Off

Switch	SPSO SW
Channel	Throttle
Position	L94%
On	Higt

Switch: Press R or L to select "SPSO SW".

Channel: Press R or L to select "Throttle".

Position: Press L to set percentage(Suggest setting is L94%).

On setting: Press R or L to select "High" as rocker direction of on.

Move up and down of the throttle to check if the direction of the switch is set correctly. Then press EXT to return "Main Menu".

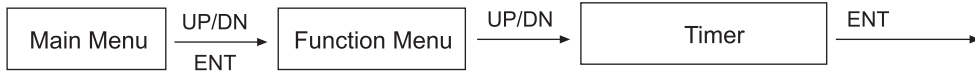

Timer ☰

Type	Stopwatch
Switch	SPSO SW

Type: Press R or L to select stopwatch or countdown.

Switch: Press R or L to select "SPSO SW".

Press EXT to return back main interface after finished.

Usage: Toggle the throttle up to L94% to start the time, toggle the throttle down to L94% to stop the time, press DN to reset.

01 ➔ Model 01 0% 00:00 ☰ ☰

Timer ↑

0 0 0 0 0 0

13.0 FCS-X4 Main controller guideline

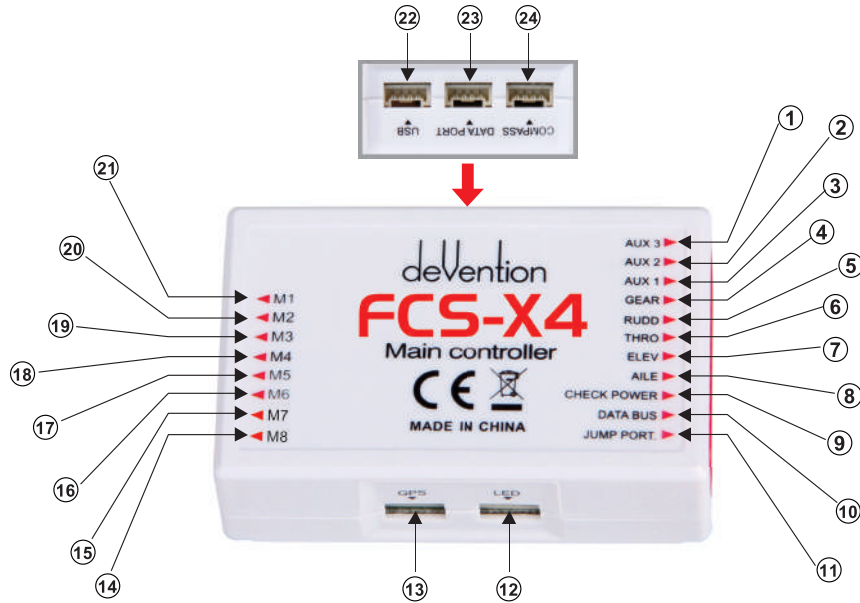

①	To roundly cruise flight mode	⑨	To check voltage(connect with power board)	⑰	Connect with fifth way brushless ESC
②	To hyper IOC	⑩	Used for data transmission-connect the PPM OUT port of BT-2401A/2402A	⑱	Connect with forth way brushless ESC
③	To one key to take off	⑪	Jumper port, when regular receiver is need, insert random equipped bind plug pls.	⑲	Connect with third way brushless ESC
④	Control Mode Switch	⑫	To link LED	⑳	Connect with second way brushless ESC
⑤	To control Rudder	⑬	To link GPS module(red white blue black four color cable)	㉑	Connect with first way brushless ESC
⑥	To control Throttle	⑭	Connect with eighth way brushless ESC	㉒	Upgrade channel
⑦	To control Elevator (forward & backward)	⑮	Connect with seventh way brushless ESC	㉓	Data communcation port
⑧	To control Aileron (leftward & rightward)	⑯	Connect with sixth way brushless ESC	㉔	To link Compass (red black double color cable)

14.0 DEVO RX707(CE)/RX709(FCC) Receiver guideling

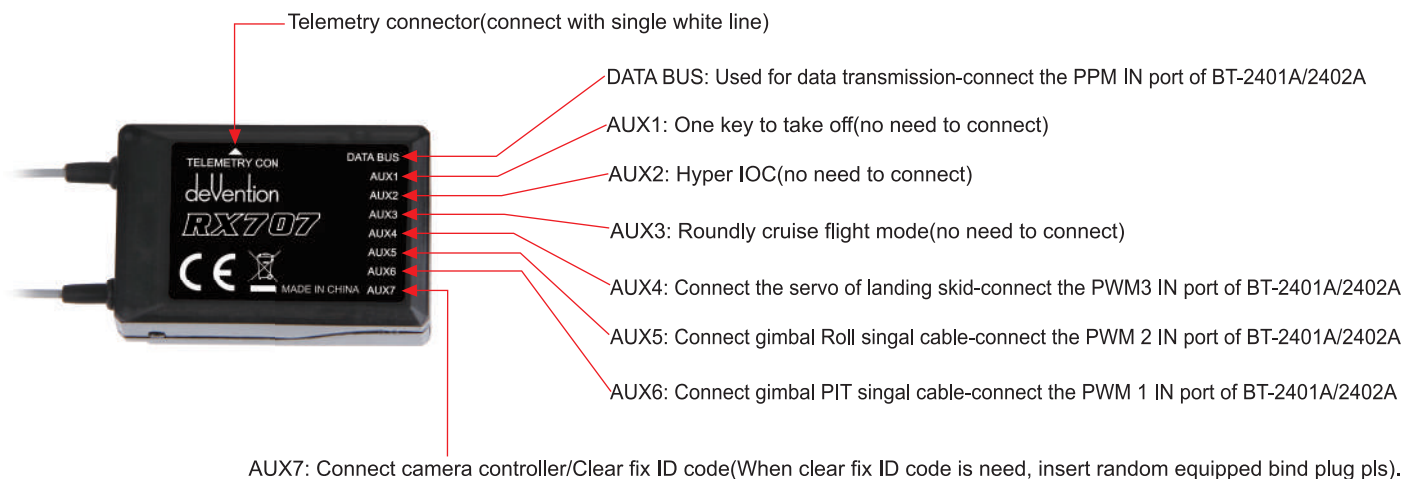

Attention: DEVO RX707(CE) and DEVO RX709(FCC)have the same ports.

15.0 Instruction for knobs of G-3D gimbal

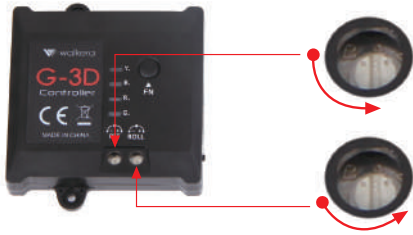

PIT: Set up gimbal tilt angle(control angle range $-135^{\circ}\sim 90^{\circ}$), please refer to the mid-point as starting point, proper adjust the knob in counterclockwise direction.

ROLL: Set up gimbal rolling angle(control angle range $45^{\circ}\sim 45^{\circ}$), please refer to the mid-point as starting point, proper adjust the knob in counterclockwise direction.

16.0 iLook+ Camera Setting

16.1 Pictures illustration

16.2 Specifications

(1) Video

- a. Video Resolution: 1920 x1080 Full HD
- b. FPS: 30
- c. Micro High Speed SD card: Max 64G
- d. Imaging Sensor: 3,000,000 Pixels
- e. Video Format: MOV
- f. Photo: 4032x3024 Pixels



(2) 5.8G wireless

- a. 5.8G wireless image transmission
- b. FCC Output Power $\leq 200\text{mW}$
- c. CE Output Power $\leq 25\text{mW}$
- d. CE Bind B section: 8 channels
- e. FCC Bind B section: 4 channels



16.3 iLook+(FCC/CE) camera transmitting channel selection

There are 8 different channels can be selected. You can choose the best frequency channel according to the image quality as bellow:

Channel	1	2	3	4	5	6	7	8
Frequency	5866MHz	5847MHz	5828MHz	5809MHz	5790MHz	5771MHz	5752MHz	5733MHz
code position (off/on)	 ON	 ON	 ON	 ON	 ON	 ON	 ON	 ON

Note: Only transmitting channel 2, 4, 6, 8 are available for the iLook/iLook+(FCC).

16.4 Video and Photo user guide

Warm tips:

- (1) Micro SD card must be inserted to the iLook+ camera before connecting the power, and took off after disconnecting the power.
(Recommend to use high speed SD card)
- (2) Insert MICRO SD card, the camera is powered on, the red indicator light indicates the camera is initialized, the red light goes out indicates the camera enters standby mode initialization is complete.
- (3) Insert MICRO SD card, the camera is powered on, if the red indicator light blinks rapidly means formatting it is necessary.pls stir video/ photo switch to 📷 position press shutter last for 5 sec.format after the completion of the proposed re-energized camera.

(1) Video instruction

(1.1) Radio Operation

Switch	Transmitter setting	Instructions
AILE D/R	<p style="text-align: center;"> Model Menu ↓ Device Output ↓ AUX7 ↓ AILE D/R ↓ Active </p>	<p>(1) It's a must to turn the switch of iLook+ to " 📷 " position.</p> <p>(2) Start video: turn the AILE D/R switch from "0" position to "1" position, wait for 1-2 seconds, then return to "0" position, the camera will start to video (the red indicator keeps flash with an interval of 0.5 second). The red indication of video status can be seen on the transmitter.</p> <p>Stop video: turn the AILE D/R switch from "0" position to "1" position, wait for 1-2 seconds, then return to "0" position, the camera will stop video (the red indicator lights out). And the red indication of video status can not be seen on the transmitter.</p> <p>(3) Make sure that the video recorded will not be saved in the SD card if you haven't finished the "stop video" operation.</p>

(1.2) Manual Operation

Turn the Video/Photo Switch to 📷 first please, press the shutter button once, iLook+ camera starts to Video(the Red indicator flash for 0.5sec interval); Press the shutter button again, iLook+ camera stops video(The Red indicator light out).

(2) Photo instruction

Please Turn the video/photo switch to 📷, Press the shutter button once, iLook camera Will take a photo (The Red indicator blinks once then light out), press the shutter button again, it will take another photo.

17.0 Connect charger instruction

Slide the power switch to "ON" position when charging, press the power button for 3-5 seconds till the power indicator keeps on.

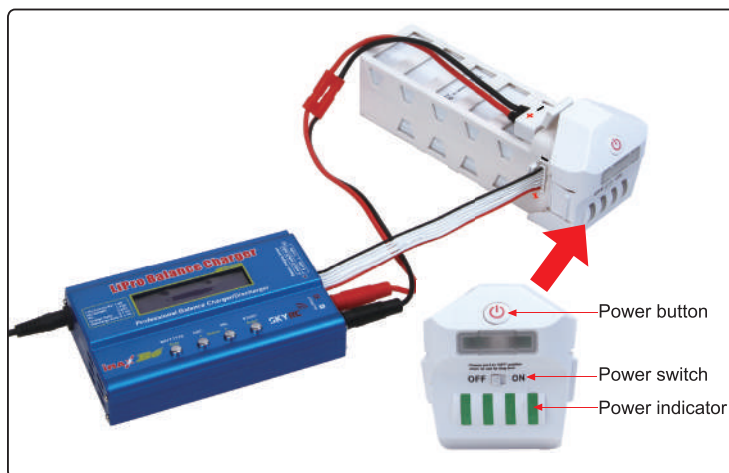

For details, please refer to iMAX B6 user manual.

Tel.: (8620) 8491 5115 8491 5116

Fax.: (8620) 8491 5117

Email: heli@walkera.com
info@walkera.com

Add.: Taishi Industrial Park, Dongchong Town
nansha District, 511475 Guangzhou

deVention

Specifications, contents of parts and availability
are subject to change, Walkera is not responsible
for inadvertent errors
in this publication.



Web: www.walkera.com