

SNAPTAIN
VISION BEYOND IMAGINATION

S50
4-AXIS DRONE

INSTRUCTIONS

Please read this manual carefully before flying and keep it well for future reference.

14⁺
FOR AGES

DISCLAIMER AND SAFETY GUIDELINES

1. DO NOT look directly into the drone light.



2. DO NOT treat the product as household waste.



3. DO NOT fly above or near obstacles, crowds, open water, public road, high voltage power lines or trees.



4. DO NOT use the drone in severe weather conditions. These include wind, snow, rain, smog, hail, lightning, tornadoes or hurricanes.



5. Stay away from the rotating propellers and motors to avoid some tiny objects (e.g. hair) to get into them.



6. This product is not a toy and not recommended for users under age 14.



7. Please maintain line-of-sight of your drone at all times after it is powered up. Do not rely on the camera image to control your drone.



» **DISCLAIMER AND SAFETY GUIDELINES**

8. This drone does not come with a GPS module. Please fly the drone within the control range and always keep an eye on the flying.



9. This product is not intended for professional aerial drone photography.



10. Be sure to observe all local regulations, obtain appropriate authorizations and understand risks. Please note it is solely your responsibility to comply with all flight regulations.



SNAPTAIN accepts no liability for damage, injury or any legal responsibility incurred directly or indirectly from the use of this product. The user shall observe safe and lawful practices including, but not limited to, those set forth in these Safety Guidelines. SNAPTAIN reserves the right to update this user manual.



MAINTENANCE AND CARE

1. Thoroughly check the drone after crash or violent impact.
2. Do not charge battery if it is hot. Let it cool down first.
3. Remove the batteries from both the drone and the remote if they will not be used for a long time.
4. Unplug the charger once it's fully charged.
5. Store the drone and remote in a cool, dry place away from direct sunlight.
6. Avoid direct contact of the camera with water or other liquids. Wipe dry with a soft absorbent cloth if it gets wet.
7. Do not charge the battery next to inflammable materials, such as carpet, wood floors or countertops etc, or on surfaces that are electrically conductive. Do not leave the battery unattended while charging.



PACKING LIST

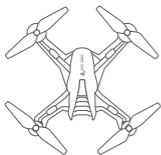

S5C Drone

Remote
(Batteries not included)Spare Propellers
A x2, B x2

Li-ion Battery x2

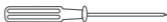

Screwdriver

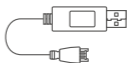

USB Charger

Spare Propeller
Cap x2

Screw Set / 8 pcs



Landing Skids x2



Propeller Guards x4



User Manual x1



FUNCTION OVERVIEW

S5C Drone

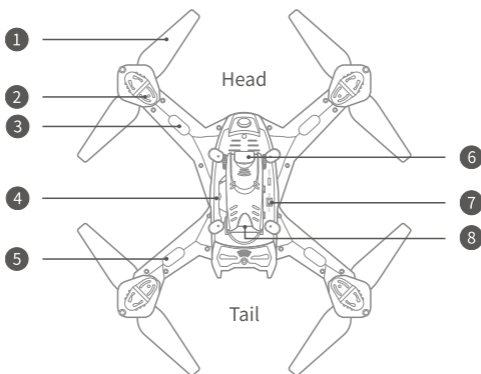

- | | |
|-----------------------|---------------------|
| 1 Propeller | 5 Rear LED |
| 2 Motor | 6 Camera |
| 3 Front LED | 7 ON/OFF |
| 4 Battery Compartment | 8 microSD Card Slot |



FUNCTION OVERVIEW

Remote

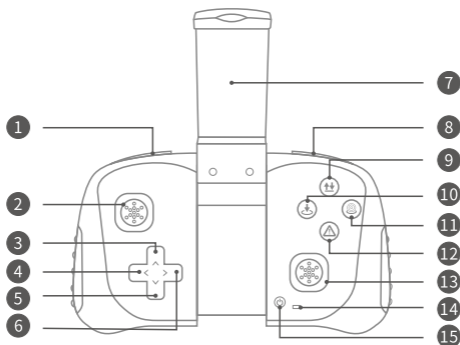

- | | |
|----------------------|---|
| 1 Speed Switch | 9 One Key Take-off/Landing |
| 2 Left Control Stick | 10 Headless Mode/One Key Return(long press) |
| 3 Forward Trim | 11 Photo/Video(long press) |
| 4 Leftward Trim | 12 Emergency Stop |
| 5 Backward Trim | 13 Right Control Stick |
| 6 Rightward Trim | 14 Power Indicator |
| 7 Phone Clamp | 15 On/Off |
| 8 360° Flip | |



FLIGHT PREPARATION

1. Install the landing skids and propeller guards into the drone, then tighten the screws.

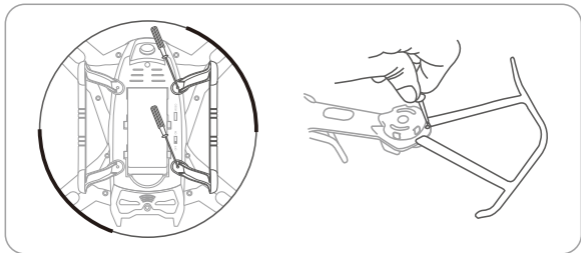

2. Charge the battery of the drone.

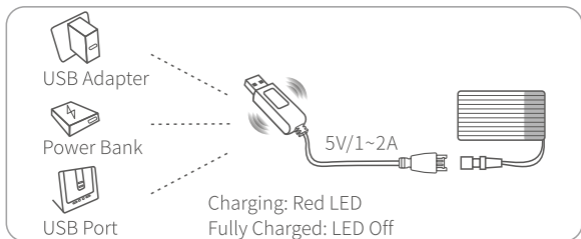

! Notes:

- * The LEDs of the drone will flash when the battery is low during flight.
- * It takes around 90mins to reach a full charge.
- * Please use the original battery and USB cable provided.
- * Keep the battery away from any sharp objects that could puncture into the battery to avoid risks of explosion and fire.
- * It's not recommended to charge the battery from the USB port of PC.



» FLIGHT PREPARATION

* Battery capacity is significantly reduced when flying in low-temperature environments. Flight time will be reduced, too. If flying in such an environment is inevitable, please keep the battery indoors or insert it into the drone for 1-2 minutes to warm it.

3. Install the drone battery after it's fully charged.

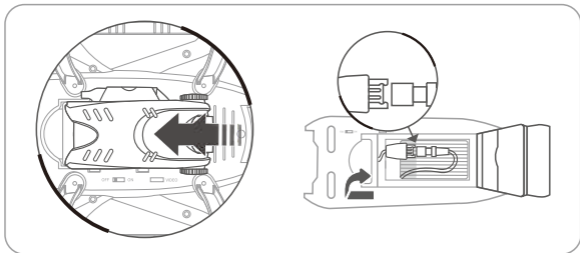

* Place your thumb on the edge of the lid covering the drone battery and slide to open.

* Push towards the head of the drone to close the battery cover.

4. Insert a microSD card (not included) into the drone.

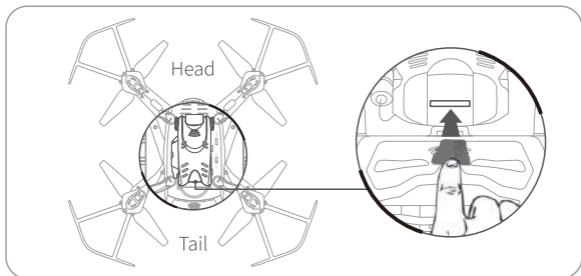

FLIGHT PREPARATION

5. Install the remote batteries.

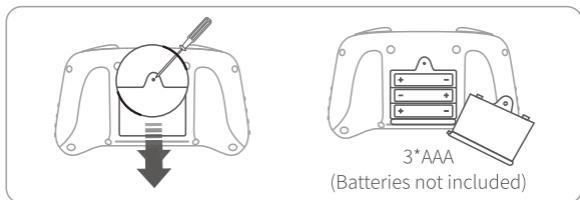

6. Unfold the **Phone Clamp** and mount your mobile device when using it to fly your drone. (Optional)

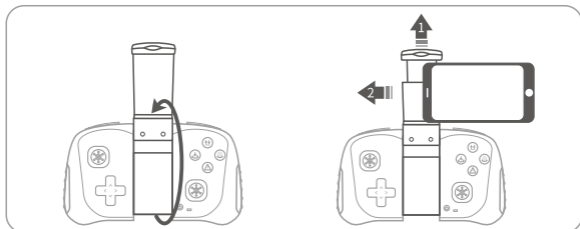

7. Replace the propellers when it's needed. (Optional)

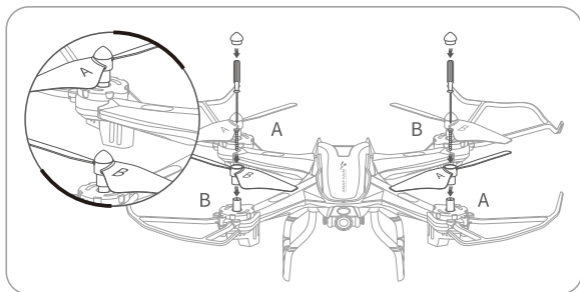

▶ FLIGHT OPERATION GUIDE

- 1 Remove the cap on the propeller.
- 2 Loosen the screw to remove the propeller.
- 3 Fit the spare propeller into the drone. Make sure the mark (A/B) on the propeller is the same as the mark on the arm of the drone.
- 4 Tighten the screw and install the cap.

FLIGHT OPERATION GUIDE

i IMPORTANT

- * Make sure you power on the drone first, then the remote in each flight.
- * Do repeat the pairing procedure each time when the drone or remote is restarted.
- * For all flight functions and modes, the operator and tail of the drone must be aligned.
- * We recommend flying in the open air and within the control range for beginners.

Remote Operation Guide

Pair the Remote with the Drone

Step 1:

Turn on the drone, then place it on a flat surface with the head forward. LEDs on the arms of the drone start to flash slowly.

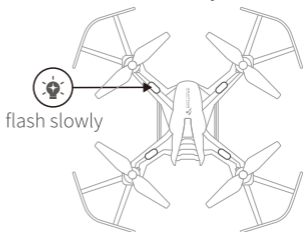
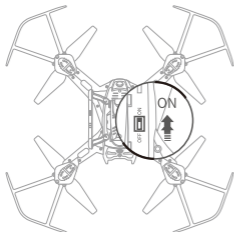

FLIGHT OPERATION GUIDE

Step 2:

Press the **On/Off** button on the remote to turn on it and there is a beep from the remote.

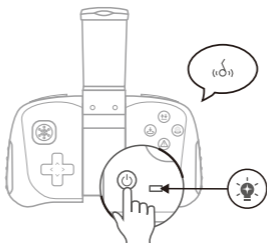

Tip:

Press and hold the **On/Off** button to turn off the remote.

Step 3:

Push the **Left Control Stick** forward to the top, then pull it backward till the bottom. Pairing is successful when the LEDs of the drone turn to solid on from quick flashing.

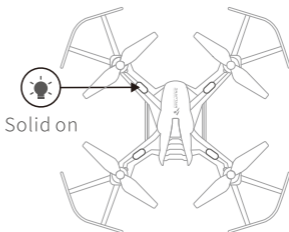
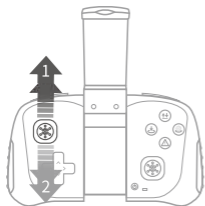

FLIGHT OPERATION GUIDE

Flight Calibration

Move both control sticks to lower left or right at 45°, then hold for 2s until you hear a long beep from the remote. Calibration completes when the LEDs of the drone turn to solid on from quick flashing.

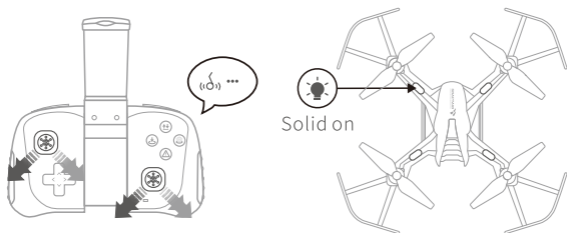

Flight Instructions

Take-off

Option 1:

Press the  button to take off.



FLIGHT OPERATION GUIDE

Option 2:

Push the **Left Control Stick** to lower left at 45° and the **Right Control Stick** to lower right at 45° at the same time until the four rotor blades start rotating, then slowly push the **Left Control Stick** forward to take off.



Flight Directions



Left Control Stick

		<p>Push the Left Control Stick forward and the drone will ascend; pull it backward and the drone will descend.</p>
	<p>Head</p> <p>Tail</p>	<p>Pull the Left Control Stick leftward and the drone will rotate to the left; pull it rightward and the drone will rotate to the right.</p>





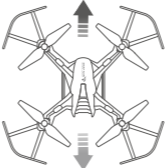

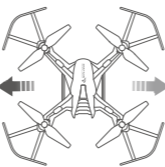
FLIGHT OPERATION GUIDE

Right Control Stick

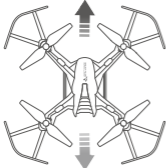
		<p>Push the Right Control Stick forward and the drone will fly forward; pull it backward and the drone will fly backward.</p>
		<p>Pull the Right Control Stick leftward and the drone will fly leftward; pull it rightward and the drone will fly rightward.</p>

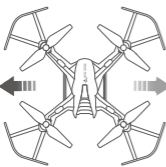
Flight Trimming

		<p>If the drone drifts forward or backward when hovering, press the Backward Trim button or the Forward Trim button to adjust.</p>
		<p>If the drone drifts leftward or rightward when hovering, press the Rightward Trim button or the Leftward Trim button to adjust.</p>



FLIGHT OPERATION GUIDE

Photo/Video

Short press the  button to take a photo. There's a beep from the remote and the rear LEDs of the drone flash once.

Press and hold the  button to start recording a video; there's a beep from the remote and the rear LEDs of the drone keep flashing while recording the video. Press and hold it again to end and save the video.

Speed Switch

The drone is set to low speed by default.

Press the  button once for **Medium** speed and there are two beeps from the remote. Press it again for **High** speed and there are three beeps from the remote.

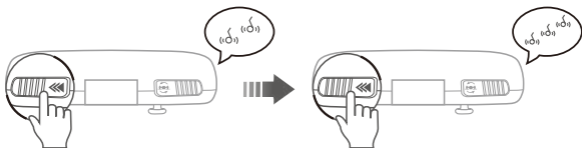

Press it the third time to get back to **Low** speed and there is one beep from the remote.

Headless Mode

Short press the  button to activate **Headless Mode**. There are continuous beeps from the remote; the LEDs of the drone flash slowly. In this mode, the drone will fly following the direction of the **Right Control Stick** regardless of the position of your drone's head or tail. Press the same button to exit this mode.



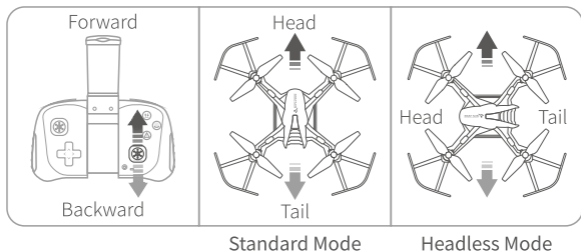

FLIGHT OPERATION GUIDE



360° Flip

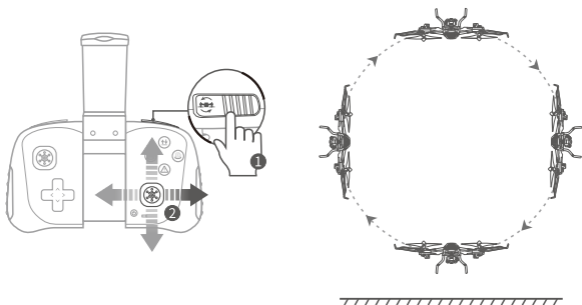

After flying the drone to a height over 2m, press the  button to activate 360° Flip function. Then move the **Right Control Stick** to flip the drone accordingly.



- * There's a beep from the remote about 2s after you press the  button, indicating that this function is cancelled. Please move the **Right Control Stick** timely to flip the drone.
- * This function can't be activated when the battery of the drone is low.

FLIGHT OPERATION GUIDE

One Key Return

Press and hold the  button, then the drone will fly toward its back following a path paralleled to its original take-off path. Press and hold the  button again or push the **Right Control Stick** forward to cancel this mode.

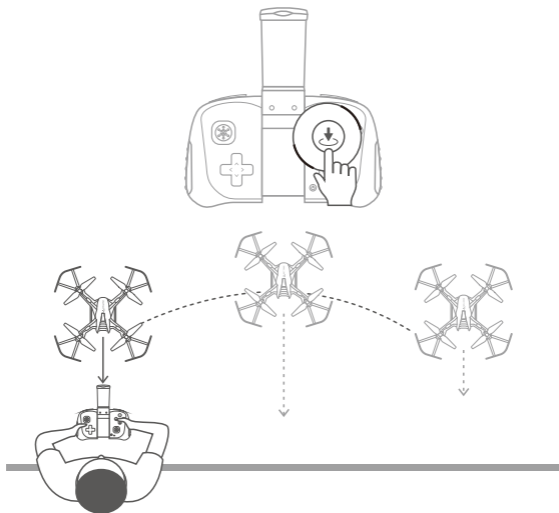

Altitude Hold/Hover

This is one of the default settings on the drone. When you release the **Left Control Stick** after an ascending/descending action, the drone will hover at the current flight height. For a stable flight, press the trim buttons to adjust accordingly.



FLIGHT OPERATION GUIDE

Landing

Option 1:

Press the  button to land the drone.



Option 2:

Slowly pull the **Left Control Stick** backward to land the drone until the propellers stop rotating.



Emergency Stop

Press the  button, then the drone will stop in the air and fall.

! Note:

It's NOT recommended to use this function during normal flight for landing, which may result in serious damage for your drone.



FLIGHT OPERATION GUIDE

App Operation Guide

App Downloading and Installation

Download and install **Snaptain Era** into your mobile device from App Store/Google Play or by scanning the QR code below.



Android



iOS

Pair the App with the Drone

Step 1:

Power on the drone and the LEDs will flash.

Step 2:

Go to the Wifi settings of your mobile device and connect to the Wifi **Snaptain-S5C-xxxxxx**.

Step 3:

Open **Snaptain Era** App. Tap **Function Display** and **ON/OFF** to turn on the App. LEDs on the drone turn to solid on at a successful connection.

Step 4:

Tap  to calibrate the drone.



FLIGHT OPERATION GUIDE

! Notes:

- * If **Snaptain-S5C-xxxxxx** is not listed or the App doesn't show the preview image, please restart the drone and search the Wifi of the drone again.
- * Make sure **Snaptain-S5C-xxxxxx** Wifi is only connected to one device.
- * It's recommended that you turn off cellular data when your mobile device connects to the Wifi **Snaptain-S5C-xxxxxx**. Otherwise, the Wifi connection with the drone may be interrupted.

Function Overview of the App

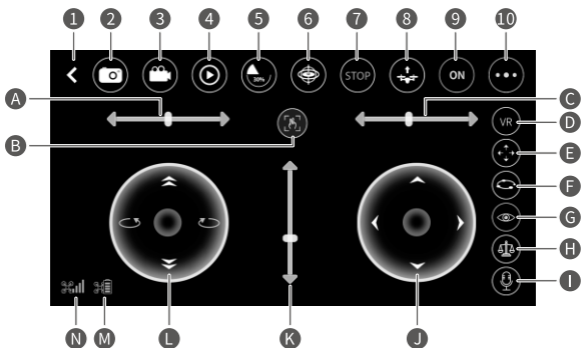

- | | |
|-----------------|----------------------------|
| ① Back | ⑥ G-Sensor |
| ② Photo | ⑦ Emergency Stop |
| ③ Video | ⑧ One Key Take-off/Landing |
| ④ Media Gallery | ⑨ App ON/OFF |
| ⑤ Speed Switch | ⑩ More |



FLIGHT OPERATION GUIDE

- A** Trim Clockwise/Anticlockwise
- B** Gestures for Photo/Video
- C** Trim Leftward/Rightward
- D** VR Mode
- E** Headless Mode
- F** Trajectory Flight
- G** Trim ON/OFF
- H** Calibration
- I** Voice Control
- J** Forward/Backward/
Leftward/Rightward
- K** Trim Forward/Backward
- L** Turn Left/Turn Right/
Ascend/Descend
- M** Battery Status
- N** Wifi Signal

More:

Tap  to hide or display icons from D to I.

Photo:

Tap  once to take one photo.

Video:

Tap  once to start recording, tap again to end and save the video.

Media Gallery:

Tap  to check the photos and videos saved to the mobile device.

G-Sensor Mode:

Tap  to activate this mode. The drone will fly following the inclines of your mobile device in its landscape orientation.

VR Mode:

VR device (not included) is required to activate VR Mode.

Calibration:

Tap  to calibrate the drone directly.

If the LEDs of the drone flash quickly after a sudden impact, please first swipe down the Left Control Stick, then tap  to calibrate the drone.





» FLIGHT OPERATION GUIDE

Voice Control:

Take off, land, forward, backward, to leftside, to rightside.

Gestures for Photo/Video:

Tap  to activate this function. Within a distance of 2-3m between you and the camera, please face the camera and make a  gesture with your right hand to take a photo, a  gesture to start/end recording a video.



Wifi Signal:

Check the Wifi status of the drone to avoid losing control. When it drops to 1 of 4 bars (), please fly the drone back immediately.

Battery Status:

Check the battery status of the drone.

Trajectory Flight:

Tap  to activate this mode. Draw a path in the blank area on the screen and the drone will fly following the path. Tap  to modify flight distance and time accordingly. Tap  again to exit from this mode.

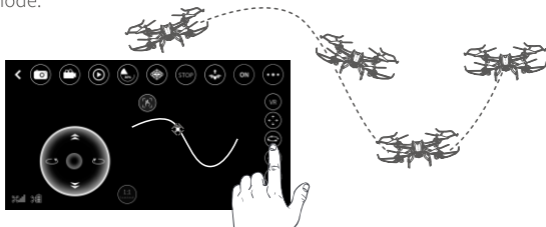

! Note:

* To fly the drone with the remote while see the image through your mobile device in the App operation mode, tap the ON/OFF icon to OFF, then pair the drone with the remote again.

PARAMETERS

Motor	816 Coreless
Control Range	≤80m
FPV Range	≤40m
Maximum Flight Relative Height	80m
Flight Time	8-10mins
Charging Time	90mins
Photo Resolution	1280 x 720
Photo Format	JPEG
Video Resolution	720P
Video Format	AVI
Storage	Save to the mobile device and microSD card (support up to 64G)
Mobile APP Requirement	Android 4.0 or above, iOS7.2 or above



» TROUBLESHOOTING GUIDE

Q1: Drone LEDs do not light up.

- * Press power button on the drone.
- * Replace or charge your drone battery.
- * Make sure the connectors of the battery are plugged in firmly.

Q2: Drone LEDs keep flashing, but the drone never responds to any command from the remote.

- * Pair the drone and remote again.
- * Replace or charge the battery of drone.
- * Make sure the batteries of the remote have enough power.

Q3: The flight is not stable.

- * Return the drone and restart to do a flight calibration as instructed.
- * Make the flight trimming accordingly.
- * Fly the drone when the weather is good.

Q4: The response from the drone to the control is not sensitive.

- * Make sure the distance between the drone and the mobile device is effective.

Q5: Connection between the drone and the App is frequently lost.

- * Make sure the distance between the drone and the mobile device is effective.
- * Make sure your mobile device is not connected to another network.

Q6: The App doesn't respond to voice commands.

- * Ensure the drone App has access to the audio function of your mobile device.

Q7: Some of the functions don't work in the App.

- * Make sure the switch for the App is ON.

Q8: The drone will fly beyond the control range.

- * Activate the Headless Mode, then move the Right Control Stick to fly the drone back.





US : support@snaptain.com

CA : support@snaptain.com

UK : support.uk@snaptain.com

FR : support.fr@snaptain.com

ES : support.es@snaptain.com