

TOPSKY

ADD

Room 204, Building B, Jiahuangyuan Technology Park, No.365,
Baotian Road 1, Xixiang, Bao'an District, Shenzhen

T E L : 0755-27369301 WEB: www.ivstopsky.com Email: topsky@hktopsky.com

foreword

Thanks for using TOPSKY F7X FPV Goggles!

Before you use this product, please read this manual carefully, and according to the manual, install and use this glasses correctly, and keep the manual properly for future reference. We will not make any compensation for any loss or injury caused by the following causes:

- Do not read this manual carefully before installation
- The glasses is not properly installed without the manual.
- Failure to operate according to the normal operation, the parts slip or injure the human body.
- Damages caused by force majeure, such as earthquake, fire, etc
- No warranty certificate and valid invoice, the product model on the voucher is not consistent with the object
- More than the effective guarantee period

Our company reserves the right to the final interpretation of this manual
Thanks again for using our products.

FPV F7X Drones Pilots's choice

-- Professional FPV

Catalog

Structure and buttons	-----	Page 1
Product parameter	-----	Page 2
RX mode Unopened Receiving mode Open Receiving Mode Mode Control Switch	-----	Page 3
DVR control key CH +/- button DVR control key	-----	Page 4
DVR control key Recording Video mode	-----	Page 5
DVR control key Photo picture playback mode	-----	Page 6
DVR control key Sound volume Power display Myopia lenses	-----	Page 7
DVR control key Language switching Commen Questions	-----	Page 8
Configuration and description Accessories list Safety Notice	-----	Page 9
Warranty card	-----	Page 10

Structure and buttons

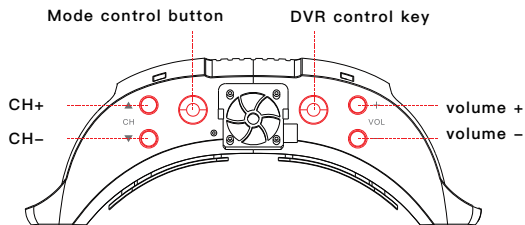
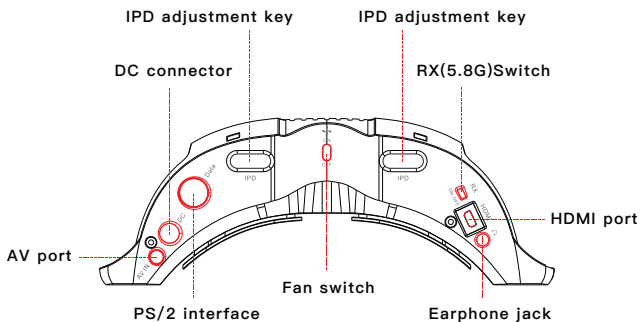

Product parameter

MODULAR 3D FPV GOGGLES

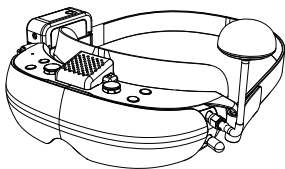

FOV	42°
Resolution	1280*720(0.5" LCoS) backlight
Video format	NTSC/PAL auto selection
Module	Head tracking module (optional)
Receiver	Built-in high-sensitivity receivers with 40 channel high-speed one-touch search
Digitas Video	MJPG 30FPS integrated mode DVR (only for RF), micro TF card and support 32GB, video compression format MJPG/30 FPS
Button adjustment	Intensity control/contrast control/ channel control/display mode control/ DVR switch/ head saturation control/tracking module
HDMI	Support 720P HDMI signal input (2D/3D auto selection)
Ports	Headphone jack/ AV-IN port/ DC IN port/ PS2
Power	DC 7-18V (3h-4h) Image voltage indicator function

RX mode

Unopened Receiving mode

Insert the battery into the DC interface and the glasses turn on automatically (At this time, the goggles is default to the AV-IN -2D mode)

After turning on , the sensor is in working condition.

Open Receiving Mode

Slide the RX switch to 'ON', opening the 5.8G signal reception mode. Slide the RX switch to 'OFF' to close the 5.8G signal reception with the snow screen.

Mode Control Switch

Press the mode control button to change AV 2D/3D OR HDMI 2D/3D.

Slide the mode control button back and forth, the screen will display the menu bar,including luminance, contrast ratio,chroma and language.The gesture icon, which will turn red when you select the desired menu.

When selecting the required menu, control key to increase or decrease brightness, contrast, chroma and Chinese and English switching.

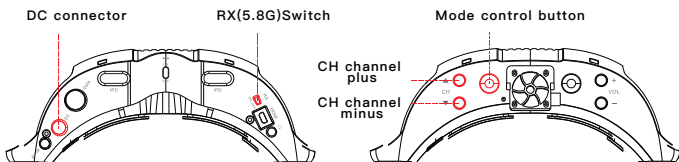

DVR control key

CH +/- button

Adjust the CH button (it will have the notice sound), select the required channel, and there are 40 the frequency channels.

In the process of choosing the channel, there is screen tip on the screen, which can see the the page jump when adjusting.

CH (red characters) 5805G (yellow characters)

When choosing the channels, 5805 the number will change, the page will jump, other invariant.

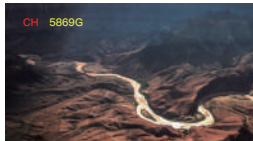

DVR control key

In the AV-2D mode, backward long press DVR key to access the recording mode interface. (There will be key beep tone and REC words, REC fonts will always show until you exit the recording mode).

In the recording mode interface, vertical long press DVR key can switch mode (video mode, video playback mode, picture playback mode).

Note: no SD card cannot be recorded.

SD card installation method: Open the front cover black lens, then you will see the SD card slot, SD card position beMarked as red as the following shown:

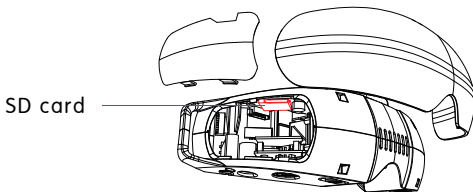

DVR control key

Recording

Enter the video mode interface, backward toggle the DVR key can start to recording.the same time, there will be a tone, the page will be REC words, REC words and the page will always be flashing, stop the video will sound twice, after recording, will stop at the current page.

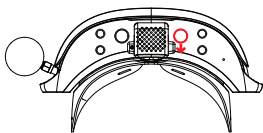

backward toggle the DVR key

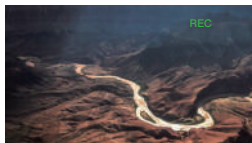

Recording/ Video page

Video mode

In the recording mode interface, long press DVR button key vertically,it can switch to the video playback mode list,Toggle DVR button key from left and right, it can play the video freely.Short press to play the video, then press briefly to pause the video being played back, press briefly to return to the video playback mode list



video playback mode
video suffix name.AVI



video playback page

DVR control key

Sound volume

Press VOL (volume) button to adjust the volume, the volume progress bar will appear under the centre position.

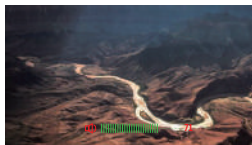

Power display

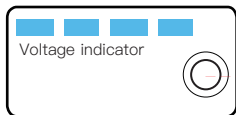

Power display button

Total 4 pcs of Indicator lights, when turns to the blue light, you can press the power display button to show the actual power. The indicator turns off automatically after 3 seconds.

Myopia lenses

Myopia lens installation method:

As shown below in the red wireframe which insert the card slot from the side (The insertion direction is indicated by the arrow)

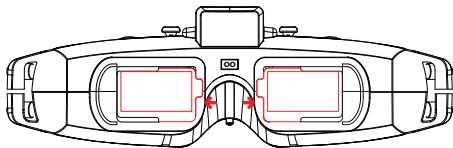

DVR control key

Language switching

Slide the mode control button front and back to display the language selection bar. Slide the mode control right and left to choose the language. The display page is as follows

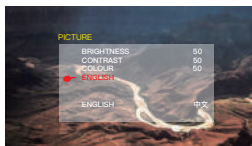

English interface



Chinese interface

Common Questions

- You must install the SD card before boot, without SD card, can not record or take pictures
- When the battery POWER is too low, the glasses will GIVE low battery alarm SOUND. Please replace with new battery at this time..
- When charging, the indicator light turns Static red. After charging is completed, the indicator light turns static yellow.
- When you select a menu, there is a finger Pointing icon which can make the menu turns red, You can then adjust the parameters by toggling from side to side.
- F7X glasses do not have power to open the key, the glasses are powered by an external battery, After power on, the glasses will turn on automatically. After the power failure, the glasses will be switched off

DVR control key

Photo

In video mode interface, right toggle can take pictures, can hear tone two times, and the page does not change.

In the video playback list, vertical short press DVR button to enter the picture list.

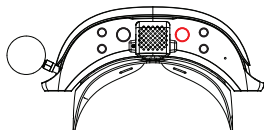

right toggle

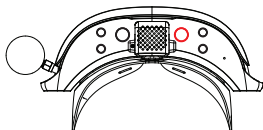

short press

picture playback mode

In the video playback list, vertical short press DVR button to enter the picture mode slide around the DVR key, can choose pictures, backward short press to view the picture, forward short press to return to the picture playback mode.

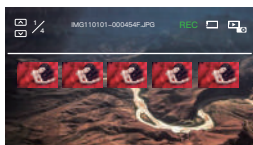

picture playback mode
picture suffix name.JPG



picture playback page



宏天科技
TOPSKY

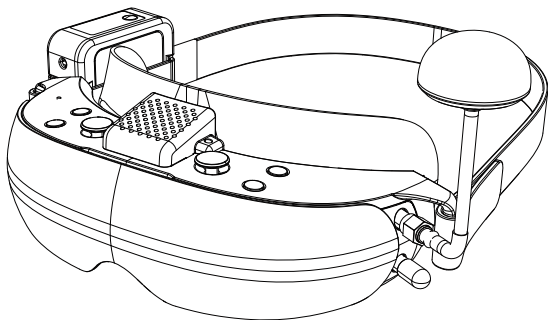

MODULAR 3DFPV GOGGLES

Please read the instructions before use

An instruction manual

Configuration and description

- Most HDMI connection problems are caused by incorrect display settings or incorrect HDMI cables. If HDMI Cable is defective, you should change the HDMI Power source and the HDMI Wire.

Accessories list

Battery	1	Bandage	1
Glass cloth	1	AV Wire	1
Charger	1	HDMI Wire	1
Goggles sponge	1	Silicone goggles	1
Two-dimensional code card	1	Detailed operating instructions	1
5.8G receiving antenna	1		

Safety Notice

- Avoid the use of products under excessive humidity environment, It may cause power leakage which give safety hazards.
- When plug in and unplug the power source, be careful not to touch the metal parts, If the bare or leakage wire is found, Replace the connecting wires immediately.
- Do not disassemble and replace the internal parts, IF the product has any abnormal damage, please cut off the power supply immediately and contact the Professional maintenance personnel for repairs

Warranty card

Fault description: _____

Username: _____ Postcode: _____

Contact NO: _____ Order NO: _____

Purchase Date: _____ Machine No: _____

Mode NO: _____ User signature: _____

Address: _____

The following conditions will not allowed to provide free warranty service

1. Damaged product by yourself
2. Customer replace the parts themself without my company technical staff to repair,change or modify
3. The product number is altered or does not match our certificate
4. Negligence to use which cause to the inner damaged
5. Failure or damaged by an accident natural disaster

Our company reserves the right to modify and interpret.