

Best solution for aerial photography

- Latest GPS control system
- 1-2KM Control Range
- High capacity battery makes long flight time
- Equipped with Brushless Gimble



User Handbook

Specifications:

Main Rotor Diameter: 582mm

Brushless Motor spec: WK-WS-28-008C

Weight: 986g (Battery included)

Main Rotor Blade Length: 232mm

Brushless ESC spec : WST-15A(G/R)

Takeoff Weight: < 1350g

Length: 289mm

Receiver: DEVO-RX703

Experience Level: Intermediate

Width: 289mm

Transmitter(option): DEVO-F7/10/7/8S/12S

Recommended Environment: Indoor/Outdoor

Height:205mm

Battery(option): 11.1V 5200mAh Lipo

Completion Level: RTF/BNF

Features:



GPS Altitude hold system



DEVO-M
Is a Multi-Axis control platform designed
for aerophotography hobbyist



High capacity battery makes
long flight time



Equipped with professional gimble
Support iLook / Gopro Hero3 / Sony(HDR-AS30V)



Professional DEVO 10 channel
(option)



One Key Go Home



Intelligent Flight Mode



Failsafe to return & Landing



Professional DEVO F7
5.8G FPV transmitter
(option)



5.8G goggle for longer FPV
transmission (option)



2.4G WiFi HD transmission
image(option)



Low voltage protection

Contents

01. Forewords	1	08. Basic Flight Instruction	6
02. Safety matters needing attention	1	8.1 Main Control System Control Mode	6
2.1 Important Statement	1	8.2 Code binding	6
2.2 Safety matters needing attention	1	8.3 Motor unlock/lock/ Stop rotating	6
(1) Far away from obstacles and people	1	8.4 Compass Calibration	7
(2) Keep away from humidity	1	09. Advanced function specification	8
(3) Proper operation and maintenance	1	9.1 The flowchart of GPS Satellites Signal (Need to connect with GPS module)	8
(4) Avoid flying alone	1	9.2 Position Hold	8
(5) Safety operation	2	9.3 One Key Go Home	8
(6) Away from highly spinning parts	2	9.4 Failsafe to Return & Landing	9
(7) Protect from heat	2	9.5 Low Voltage Protection	10
2.3 Attention before flight	2	9.6 Intelligent Orientation Control(IOC) Flight	10
03. Definition of Aircraft Orientation	3	10. Transmitter Setting	11
04. Equipments	3	10.1 DEVO-10(optional radio) setting.....	11
05. Assembly Instruction	4	10.2 DEVO-F7(optional radio) setting	13
5.1 Propellers Installation	4	10.3 DEVO-7(optional radio) setting	15
5.2 Compass & Landing Gear Installation	4	10.4 DEVO-8S/12S(optional radio) setting	16
06. Brushless ESC/Brushless motor/Power board connection	4	11. Instruction and attention of GA005 balance charger	17
6.1 Brushless ESC and Brushless motor Connection	4	11.1 Parameters of GA005 balance charger	17
6.2 Brushless ESC and Power board Connection	4	11.2 Features of GA005 balance charger	17
07. Main control board guideline	5	11.3 Instruction of GA005 balance charger	17
7.1 Main controller: DEVO-M	5	11.4 Operation steps	17
7.2 Main control board(DEVO-M) and..... Brushless ESC Connection Illustration	5	11.5 Charging status corresponding to LED	18
7.3 Receiver: RX703	5	11.6 Matters needing attention	18
7.4 Main Control Board Installation Requirements	5	11.7 Maintenance of battery pack	18
		12. Steps of flight	19
		13. Flight over	19
		Appendix 1 – Manual flight control	19
		Appendix 2 – Trimming the Manual flight actions	20



01

Forewords



02

Safety matters needing attention

Dear customer:

Thank you for purchasing a Walkera radio control aircraft product. In order to quickly and safely master the operation of the "QR X350PRO", please read the user handbook carefully and then keep it in a safe place for future consultation and reference.

2.1 Important Statement

- (1) This product is not a toy. It is a piece of complicated equipment which harmoniously integrates engineering materials, mechanics, electronics, aerodynamic and high frequency radio. Correct installation and adjustment are necessary to avoid accidents taking place. The owner must always operate in a safe manner. Improper operation may result in serious property damage, bodily injury or even death.
- (2) We accept no liability for damage and consequent damage arising from the use of these products, as we have no control over the way they are maintained, used and operated.
- (3) This product is suitable for experienced Aircraft pilots aged 14 years or more. All minors must be accompanied by a responsible adult when flying.
- (4) The flight field should be legally approved by the local government. We accept no liability for any safety duties or fines arising from operation, usage or mis-control after the sale of the products .
- (5) We consign our distributors to offer technical support and service after sale. Please contact the local distributors for problem resolution caused by usage, operation, maintenance, etc.

2.2 Safety matters needing attention

Aircraft flight is a high risk hobby, whose flight should be kept far away from other people. Mis-assembled or broken main frame, defective electronic equipment, and/or problematic radio system will lead to unforeseen accidents such as bodily injury or property damage. The pilot **MUST** pay attention to the flight safety and UNDERSTAND his responsibility for accidents caused by his carelessness.

(1) Far away from obstacles and people

An Aircraft in flight has risk of uncertain flight speed and direction which is potentially dangerous. When flying, please keep your Aircraft far away from people, high buildings, high-tension lines, etc, and avoid operating in rain, storms, thunder and lightning.



(2) Keep away from humidity

Aircraft should be kept away from humidity and vapor because its complex, precise electronic components and mechanical parts may be damaged.



(3) Proper operation and maintenance

Please use Walkera original spare parts to upgrade, modify or maintain your Aircraft in order to ensure its safety. Please operate your Aircraft within the range of functions permitted. It is forbidden to use it outside of the safety laws or regulations.



(4) Avoid flying alone

At the beginning of learning about radio-controlled flight there are some difficulties to overcome. Please avoid flying alone. Invite experienced pilots to guide you (two of the most effective methods to practice are via a PC flight simulator and/or under the supervision of a skilled pilot).



(5) Safe operation

Please fly your Aircraft according to your physical status and flight skills. Fatigue, listlessness and mis-operation will increase the possibilities of accidental hazard.



(6) Away from highly spinning parts

Please keep pilot, people and object away from the spinning blades of both main rotor and tail rotor.



(7) Protect from heat

An Aircraft is made from metal, fiber, plastic and electronic components, etc. Please keep away from heat and sunshine in order to avoid distortion, even damage, caused by high temperatures.



2.3 Attention before flight

- (1) Ensure the battery packs of both transmitter and receiver are fully charged (saturated).
- (2) Ensure both the throttle stick and the throttle trim of your transmitter stay at the lowest positions before operation.
- (3) Please strictly obey the order of turn-on and turn-off before operation. When starting your flight, please turn on your transmitter first, and connect the power cable of your helicopter last. When finishing your flight, please disconnect the power cable of your helicopter first, and turn off your transmitter last. An upset in the order of connection may cause your helicopter to loose control. Please cultivate a correct habit of turn-on and turn-off.
- (4) Assure there are solid connections between the power cables of battery pack and motors. Continuous vibrations in flight may loosen the battery tie-ins.



02

Safety matters needing attention

We define the orientation of Aircraft in order not to cause confusion in the following descriptions. That is to say, the tail boom of Aircraft is facing the pilot (tail in), and its head facing forward (front of pilot). The left hand of pilot is the left side of Aircraft, the right hand of pilot is the right side of Aircraft Its head is to the front and its tail boom is to the back. The direction in which main body of Aircraft is facing is up, and its skids are facing down.

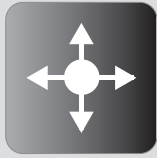
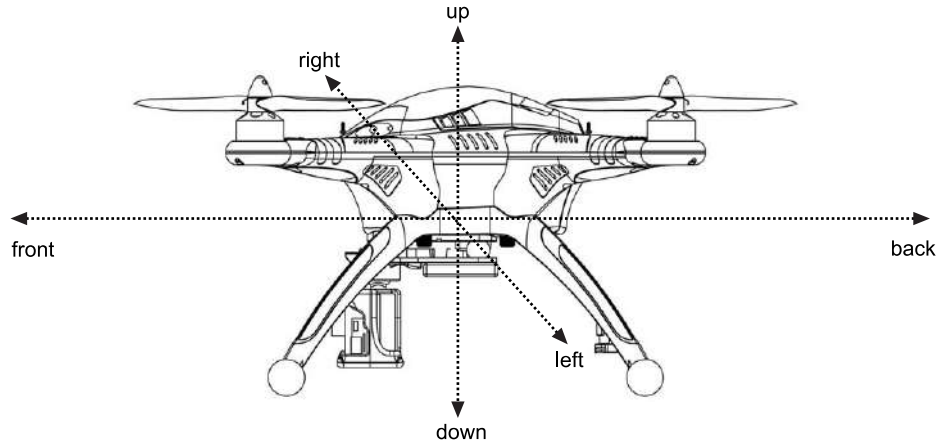

03

Definition of Aircraft Orientation



04

Equipments



▲ QR X350PRO



▲ Transmitter (Option)



▲ Li-polymer battery pack(Option)



▲ Charger(Option)



▲ ILOOK Camera(Option)

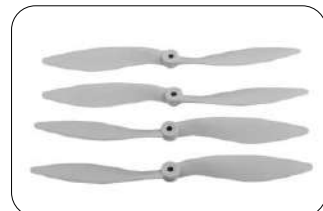

▲ Main rotor blades



▲ User Handbook



▲ Tool kit

QR X350PRO is an all-in-one new model, which is specialized design for Walkera fans. All testing has been finished before out of factory, only simply set up is needed before your ready to fly.

5.1 Propellers Installation

- (1) Take out the aircraft and propellers.
- (2) When install propellers, the side with spin-mark must be UP and make sure the rotating direction between spin-mark and motor is the same (The arrow indicates motor rotating direction).
- (3) Tighten the ornament cap (thread lock not recommended).

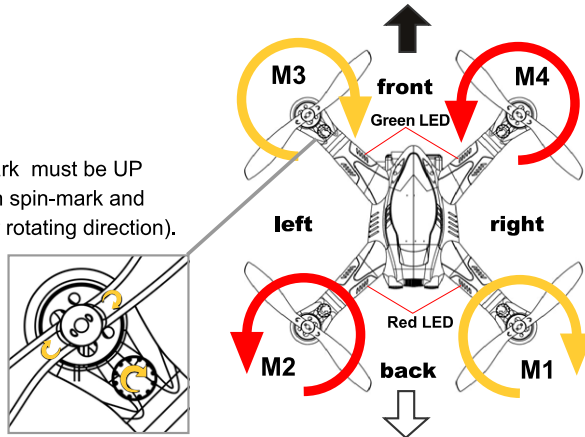

5.2 Compass & Landing Gear Installation

Please install landing gear properly, connect and calibrate the compass module.

- (1) Prepare aircraft and landing gear.
- (2) Firstly, install the landing gear with compass on the right side of the aircraft, let ribbon wire go through the landing gear hole, fix the landing gear with screw, connect the compass to ribbon wire.
- (3) Install the other landing gear on the left side of the aircraft, and fix the antenna and compass ribbon wire on landing gear via white adhesive plaster separately.

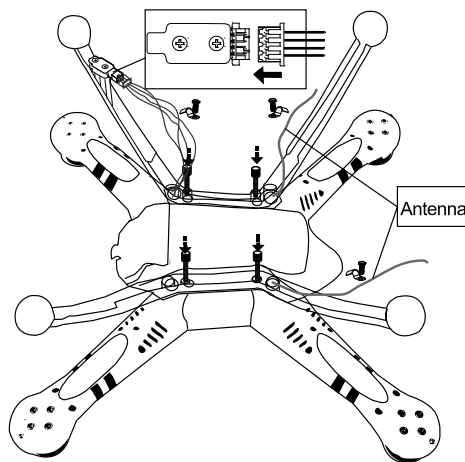

6.1 Brushless ESC and Brushless motor Connection

M1/M3 brushless motor is clockwise rotation, please follow the order to connect the wires with yellow, green, red from outside to inside; M2/M4 brushless motor is counterclockwise rotation, please follow the order to connect the wires with green, yellow and red from outside to inside (Illustration 6.1).

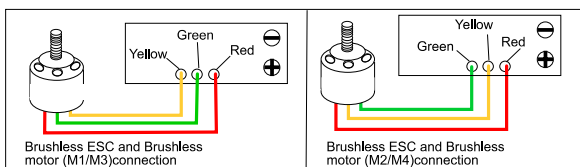

6.1 Brushless ESC and Brushless motor Connection

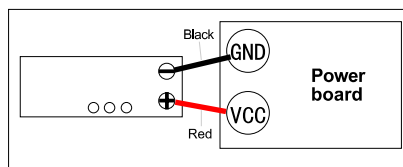

6.2 Brushless ESC and Power board Connection



05

Assembly Instruction



06

Brushless ESC/ Brushless motor/ Power board connection



07

Main control board guideline

7.1 Main controller: DEVO-M

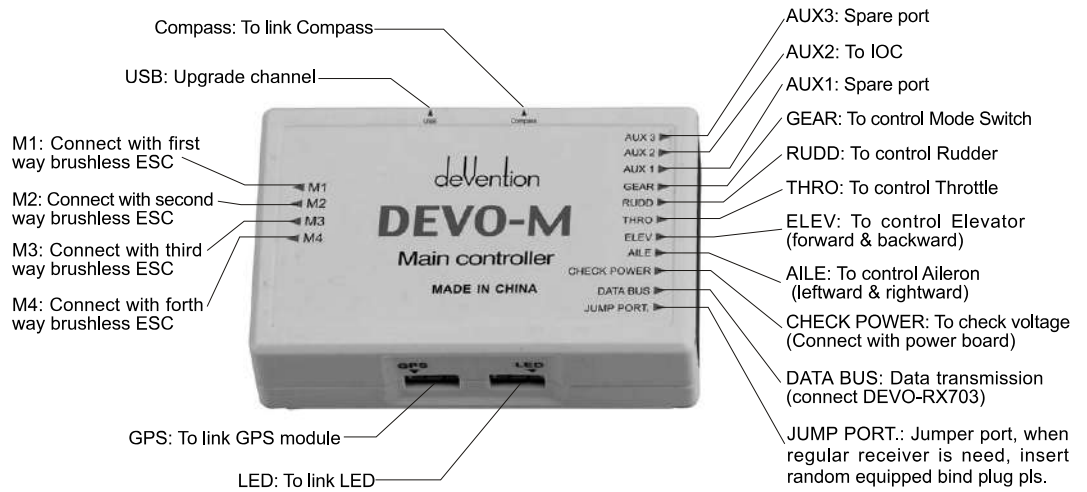

7.2 Main control board(DEVO-M) and Brushless ESC Connection Illustration

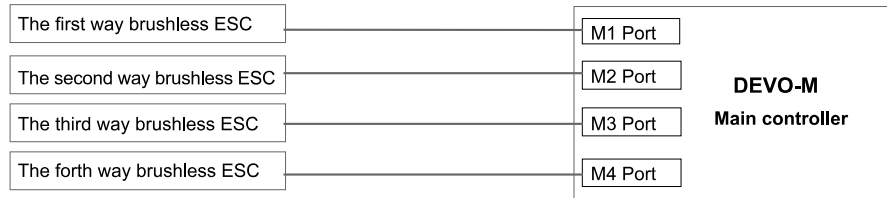

7.3 Receiver :RX703

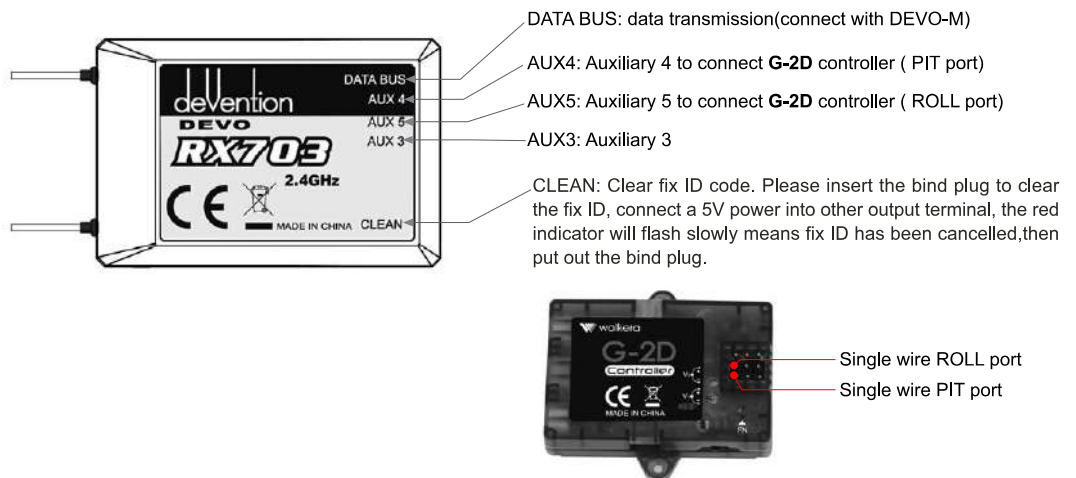

7.4 Main Control Board Installation Requirements

- (1) Label side towards the top of the aircraft.
- (2) Side with ESC connector towards forward of the aircraft.
- (3) Keep horizontal with the body of the aircraft.
- (4) Please install the main control board at the CG positon and keep all ports are free to connect.



8.1 Main Control System Control Mode

8.1.1 Control Mode Classification

There are three control modes according to the 3-position switch: Manual Mode \ Position Hold Mode \ One Key Go Home.

8.1.2 Control Mode Switch Setting (The factory setting is RTF, the default setting use "MIX" switch. please refer "Transmitter device output" for method).

Please choose a 3-position switch as control mode switch before flight.

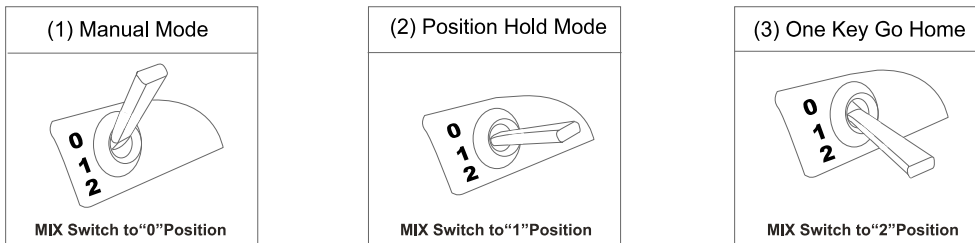

8.2 Code binding

Please follow the rule "Turn on transmitter first and aircraft battery later" Turn on the radio first, please connect the aircraft power in 10 second later. The Code binding successfully when the left green LED indicator flash quickly to slowly and then light out last.

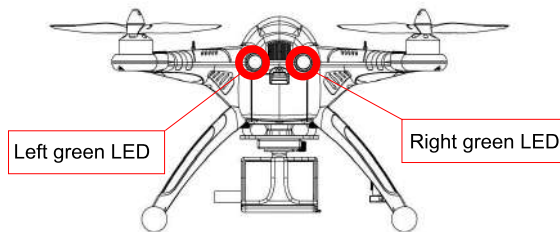

8.3 Motor unlock/lock/ Stop rotating

8.3.1 Motor unlock

Once binding, push the throttle stick to the lowest position and **keep the throttle trim at the neutral position**. Then push the rudder stick to the far left side and the Left green LED indicator turn solid Green, that means motors are unlocking. If you push the throttle up, the motors will rotate. (Note, the motors can unlock only under manual mode)

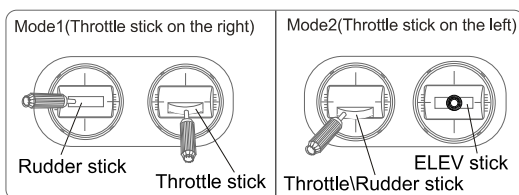

8.3.1 Motor unlock

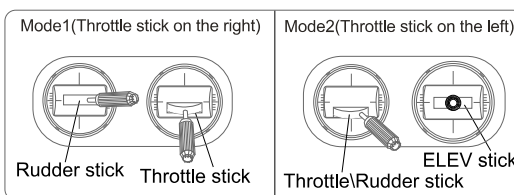

8.3.2 Motor lock

8.3.2 Motor lock

Down the throttle stick to the lowest position, move the rudder stick to far right, the motors are locked when the left green LED indicator light out. If you push the throttle up, the motors won't rotate.

Notes: The aircraft is in Motor lock status after Code binding successfully.

8.3.3 Motors stop rotating

If you push the throttle to the lowest position, the motors stop rotation.

8.3.4 Notes

- (1) After unlock, the motors would get into lock status after 10 seconds.
- (2) The factory default setting for the motors are locked after finished ID binding.



08

Basic Flight Instruction

8.4 Compass Calibration

After successful calibration for QR X350PRO, it's just plug and play to use.

The following condition need to calibrate the compass:

- (1) The first time for flight, it takes longer time to inspect the GPS signal.
- (2) When you are in a new environment.

8.4.1 Compass Calibration

Please inspect the motors lock or not before calibration. The factory default setting for the motors are locked after finished ID binding. If the aircraft need to re-calibration after flight, it is a must to lock the motors again before calibration.

- (1) Put aircraft to the horizontal position to lock the motors (lock method refer to 8.3.2).

- (2) MODE 1: keep the throttle stick at the lowest left corner and push the elevator and rudder stick to the lower right corner, compass calibration mode entered.

Mode 2: Keep the throttle/rudder sticker to the lowest position and move to the right side, then push the Elevator stick to the lower left corner, compass calibration mode entered.

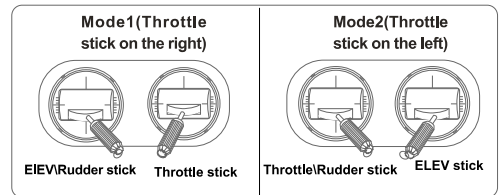

- (3) Rotate the QR X350PRO 360 degree according to forward/backward, left/right and horizontal level orientation (please follow the figures) and leave it on the horizontal place for 30 seconds, the left green LED flash quickly till light out which means calibration finished.

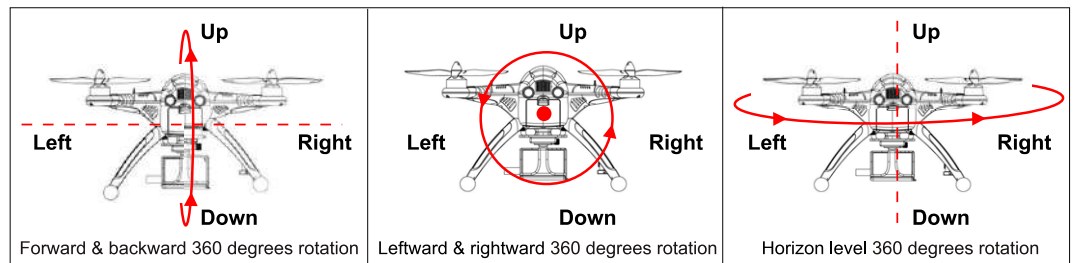

- (4) Please reconnect the aircraft power after calibration.

8.4.2 Notes:

- (1) Please keep away from magnetic materials area to calibration.
- (2) Please recalibrate the compass when the vehicle is circled and drifted during the flying.
- (3) Please recalibrate the compass if it is replaced or the vehicle position is changed.
- (4) Please check whether there is a strong magnetic field nearby disturbing the compass if the calibration is failed constantly.
- (5) Please reconnect the power of the aircraft and recalibrate the Compass if crash.

9.1 The flowchart of GPS Satellites Signal(Need to connect with GPS module)

Notes: The starting position means a point before the departure of the flight control system initialization and automatically check the complete aircraft location.

GPS Satellites	<5	5	6	7	8	9	10	11	12
The right Green LED status	No blinking	Blinking once	Blinking twice	Blinking 3 times	Blinking 4 times	Blinking 5 times	Blinking 6 times	Blinking 7 times	Blinking 8 times

9.2 Position Hold

9.2.1 Here pre-conditions for Hold Position:

- (1) The Aircraft is in normal flight status and battery voltage is normal.
- (2) GPS function and signal is in good condition (≥ 5 satellites, the right Green LED blinking)

Position Hold Setup:

When toggle the MIX switch to "1" position (don't move other sticks) during flight under manual mode, it means the QR X350PRO entered Position hold mode. **Please keep the throttle stick at neutral position under this mode.**

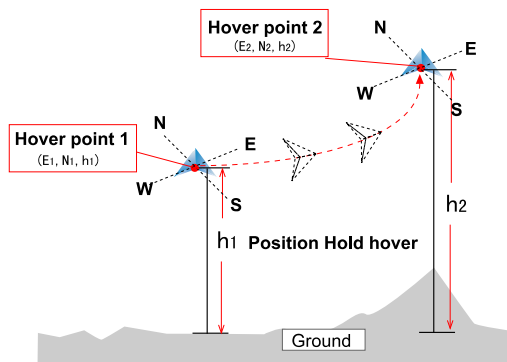
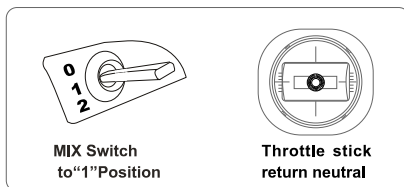

9.2.2 Note

- (1) The flight status can be controlled by radio under GPS position hold mode. Throttle stick should be neutral first if you want the QR X350PRO hold at other points.
- (2) Please use manual mode to start to fly, switch to hold position mode the aircraft will hover stable, after landing to the ground and push the throttle stick to the lowest position, the motor can lock automatically, and later need to re-switch to manual mode the motor can unlock.

9.3 One Key Go Home

Starting position is the place where the main control board finishes initialization and auto check before taking off.

9.3.1 Here pre-conditions for One Key Go-Home:

- (1) The Aircraft is in normal flight status and battery voltage is normal.
- (2) GPS function and signal is in good condition (≥ 5 satellites, the right Green LED blinking).

One Key Go Home Setup:

When toggle the MIX switch to "2" position (don't move other sticks) during flight under manual mode, it means the QR X350PRO entered One Key Go Home. **Please keep the throttle stick at neutral position under this mode.**

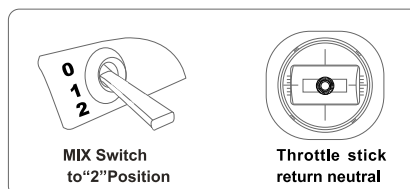

09

Advanced
function
specification



09

Advanced function specification

9.3.2 The flowchart of One Key Go-Home

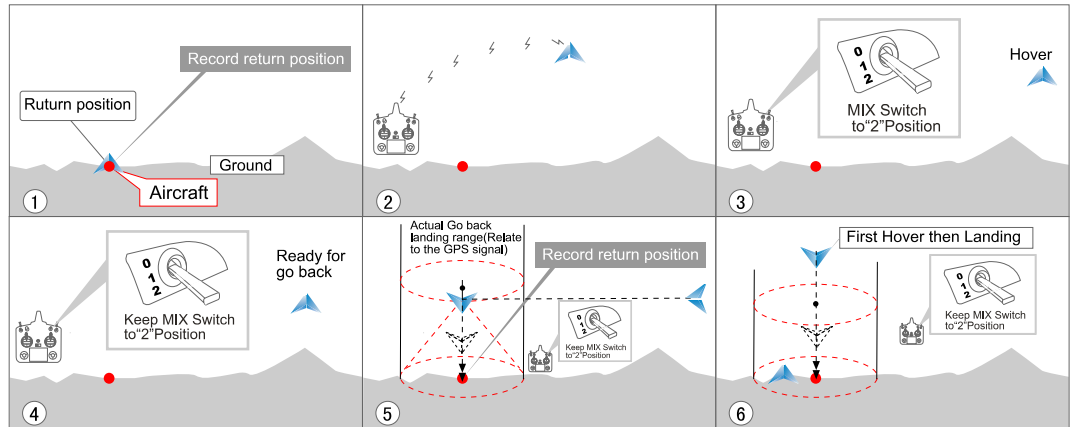

9.3.3 Notes

- (1) Please use manual mode to start to fly, switch to one key go home mode the aircraft begin to return home, after landing to the ground and push the throttle stick to the lowest position, the motors would lock automatically, and later need to re-switch to manual mode the motors can unlock.
- (2) To make sure the safe usage, please make sure to record the starting position before departure and know exactly where the starting position is.
- (3) When return home the aircraft straight flight along the line on the horizon which between the start position and the failsafe point.
- (4) The aircraft may be stuck if there are big obstacles around or windy conditions.
- (5) When GPS signal is bad or GPS is unable to work, the failsafe will not work and the aircraft will not return.

9.4 Failsafe to Return & Landing

It is a protective measure that prevents aircraft from missing signal and out of controlling. When aircraft lose control signal, it can enter Failsafe go home automatically.

9.4.1 The flowchart of Failsafe to Return and Landing

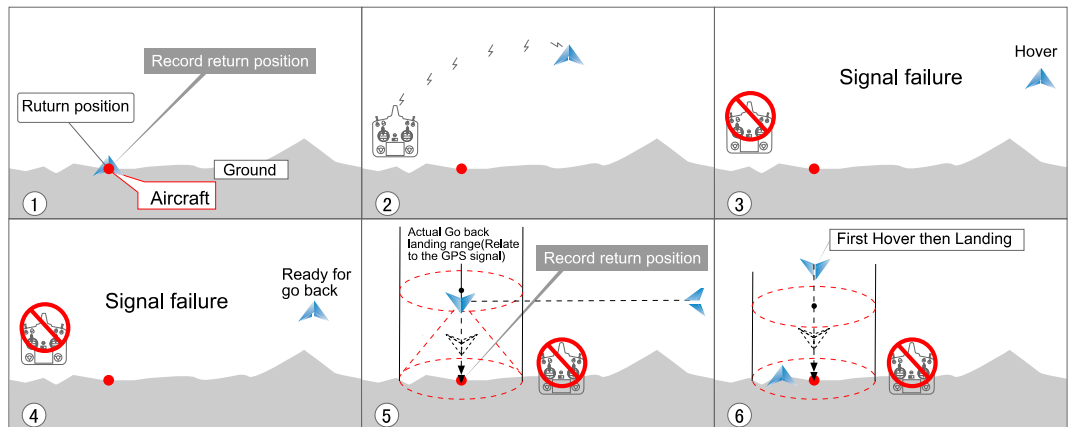

9.4.2 Notes

- (1) To make sure the safe usage, please make sure to record the starting position before departure and know exactly where the starting position is.
- (2) When return home the aircraft straight flight along the line on the horizon which between the start position and the failsafe point.
- (3) The aircraft may be stuck if there are big obstacles around or windy conditions.
- (4) When GPS signal is bad or GPS is unable to work, the failsafe will not work and the aircraft will not return.

9.5 Low Voltage Protection

Low Voltage Protection is a design to avoid the aircraft to crash by the low voltage of the battery. When the battery voltage is too low, the left green LED will slow blink warning, the aircraft will descent slowly.

Attention: The voltage alarm will be reminding when the aircraft at fixed point and fixed height or one key return mode, please switch to manual mode to control as soon as possible.

9.6 Intelligent Orientation Control (IOC) Flight

9.6.1 Make sure before use IOC function

- (1) Aircraft is in normal condition and battery is full charged.
- (2) Please make sure you know the basic flight and then use this function. You can make it fly back smoothly by ELEV Stick after activate the function.

9.6.2 IOC Definition

In the IOC mode, the quadcopter's forward direction moves by ELEV/AILE stick of the transmitter and only be related by the original RX binding position. Because the RX reset position determined the quadcopter's flight direction in IOC mode. And the flight direction be no relative with the head direction or the radio control direction.

Note:

- (1) In Manual mode, the quadcopter's flight direction is same as its head direction.
- (2) In IOC mode, the quadcopter's flight direction is same as the RX reset position.

9.6.3 IOC Setup

Turn the FMOD switch to Position "2", the quadcopter enter into IOC mode, in IOC mode, the quadcopter can move by the ELEV/AILE stick of the transmitter (if RTF, the default switch is FMOD and it is close. For setting, please ref to radio setting).

Note:

- (1) The quadcopter is in manual mode when FMOD switch turns to position "0" and "1";
- (2) The quadcopter is in IOC mode when FMOD switch turns to position "2".

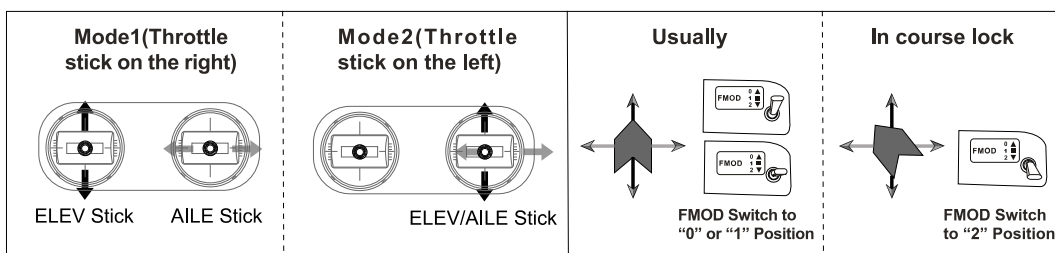

Graphic description: forward direction nose direction

9.6.4 Attention

- (1) Please don't make flight after you activate IOC.
- (2) Please close IOC when you do normal flight.



09

Advanced
function
specification



10

Transmitter Setting

10.1 DEVO-10(optional radio)setting

10.1.1 Boot Screen

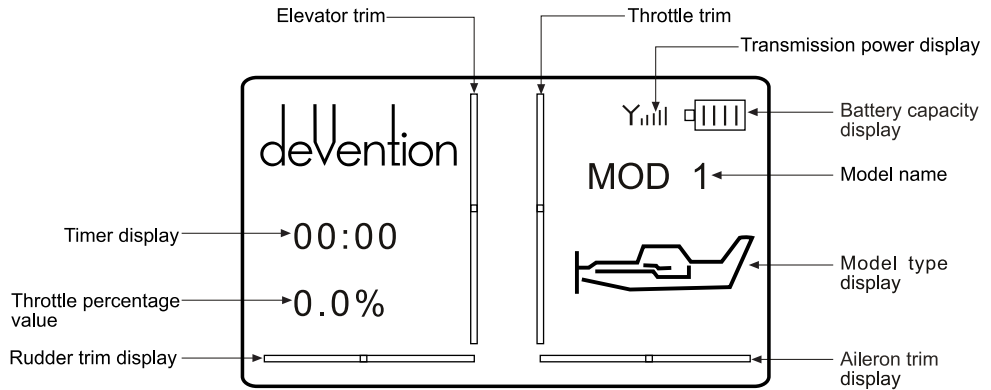

10.1.2 Type Select

Press ENT to get Main Menu and press UP or DN to select Model Menu, press ENT to enter Model Menu; Press UP or DN to select Type Select and press ENT to enter Type Select setting interface. Press R or L to get the icon of **Airplane** and press ENT to confirm, then press EXT to return to Model Menu.

10.1.3 Model Select

Press UP or DN to select Model select in Model Menu, press ENT to enter Model Select setting interface; Press UP or DN to select MOD 1, press ENT to confirm and then press EXT to return to Model Menu.

10.1.4 Model Name

Press UP or DN to select Model Name in Model Menu, press ENT to enter Model Name setting interface; Press UP or DN to select the character and figure which need to be changed, press R or L button to change the character and figure, named model as X350PRO. Press ENT to confirm and then press EXT to return to Model Menu.

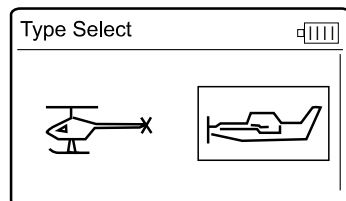

10.1.2 Type Select

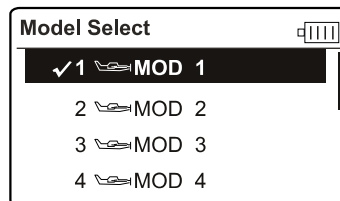

10.1.3 Model Select

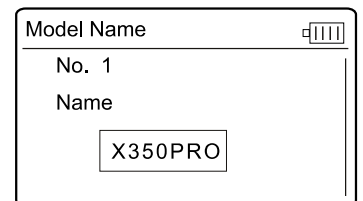

10.1.4 Model Name

10.1.5 Wing Type

Press UP or DN to select Wing Type in Model Menu, press ENT to enter the Wing Type setting interface; Press UP or DN to select "Wing Type" setting, press R or L to select "Normal", then press ENT to confirm and then press EXT to exit.

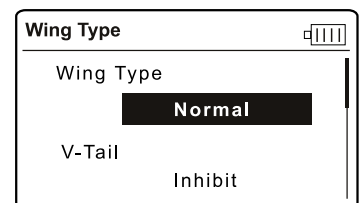

10.1.6 Device Output

Press UP or DN to select Device Output in Model Menu, press ENT to enter the Device Output setting interface.

(1) Gear setting

Press UP or DN to select "Gear" setting, press R or L to select "MIX SW"; Press UP or DN to select "Function" setting, press R or L to select "Active".

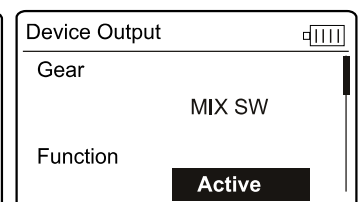
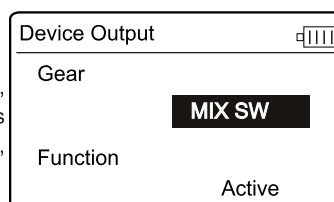

(2) Flap setting

Press UP or DN to select "Function" setting below Flap, press R or L to select "Active"; Press UP or DN to select "Flap" setting, press R or L to select "GEAR SW".

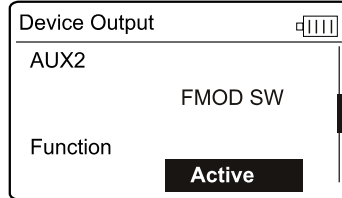
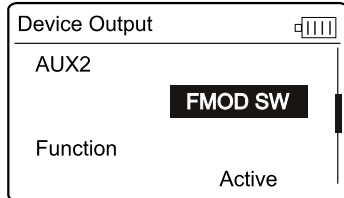
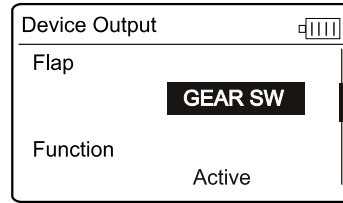
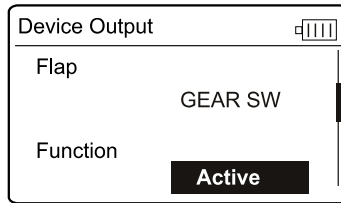

(3) AUX2 setting

Press UP or DN to select "AUX2" setting, press R or L to select "FMOD SW"; Press UP or DN to select "Function" setting, press R or L to select "Active".

(4) AUX3 setting

Press UP or DN to select "AUX3" setting, press R or L to select "RUDD D/R"; Press UP or DN to select "Function" setting, press R or L to select "Active".

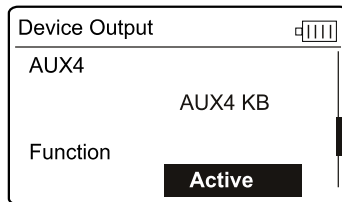
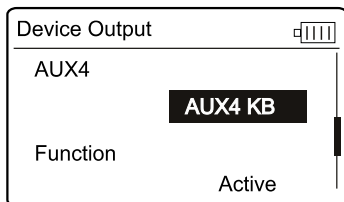
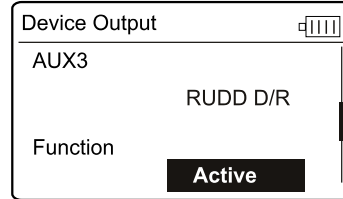
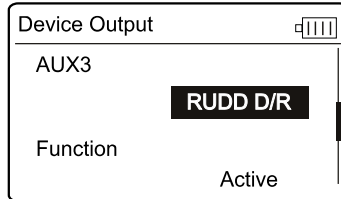

(5) AUX4 setting

Press UP or DN to select "AUX4" setting, press R or L to select "AUX4 KB"; Press UP or DN to select "Function" setting, press R or L to select "Active".

(6) AUX5 setting

Press UP or DN to select "AUX5" setting, press R or L to select "AUX5 KB"; Press UP or DN to select "Function" setting, press R or L to select "Active".

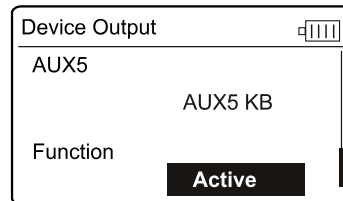
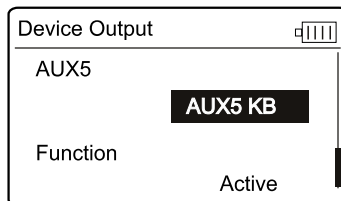

After finish setting, press ENT to EXT return to main menu.

10.1.7 Reverse Switch

Press UP or DN to select Function Menu in Main Menu, press UP or DN to select Reverse Switch and press ENT to enter the Reverse Switch setting interface; Press UP or DN to select channel, press R or L to shift the status between normal and reverse, and press ENT to confirm and then press EXT to exit.

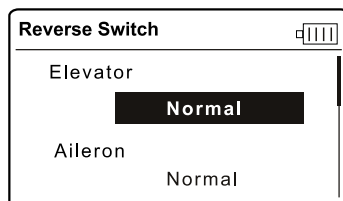

Channel	Elevator	Aileron	Throttle	Rudder	Gear	Flap	AUX2	AUX3	AUX4	AUX5
Status	Normal	Normal	Normal	Normal	Normal	Normal	Normal	Normal	Normal	Normal



10

Transmitter Setting



10

Transmitter Setting

10.2 DEVO-F7(optional radio) setting

10.2.1 Boot Screen

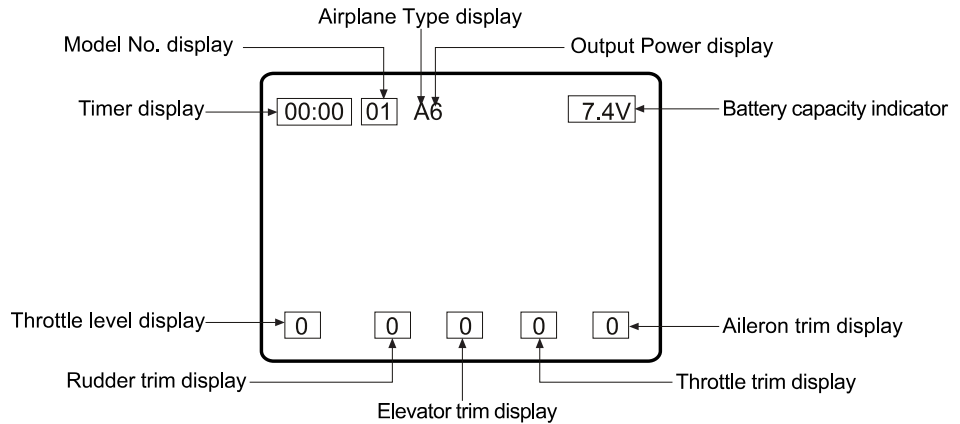

10.2.2 Type Select

Press ENT to the Main Menu. Press UP or DN to move the cursor → to point to Model Menu, press ENT to Model Menu; Press UP or DN to move the cursor → to point to Type Select, press ENT to Type Select setting interface; Press UP or DN to move the cursor → to point to **Airplane** option. Press ENT to confirm and then press EXT to return to Model Menu.

10.2.3 Model Select

Under Model Menu interface, press UP or DN to move the cursor → to point to Model Select, press ENT to Model Select; Press UP or DN to move the cursor → to point to desired option. Press ENT to confirm and then press EXT to return to Model Menu.

10.2.4 Model Name

Under the Model Menu interface, press UP or DN to move the cursor → to point to Model Name, press ENT to Model Name setting interface; press UP or DN to move the cursor → to point to select the character and figure which need to be changed, press R or L button to change the character and figure, name model as X350PRO. Press ENT to confirm and then press EXT to return to Model Menu.

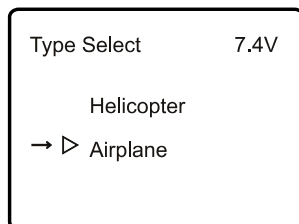

10.2.2 Type Select

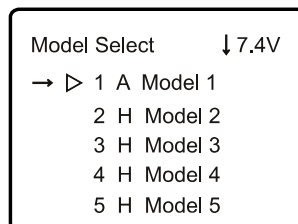

10.2.3 Model Select

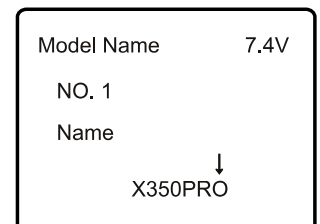

10.2.4 Model Name

10.2.5 Wing Type

Under the Model Menu interface, press UP or DN to move the cursor → to point to Wing Type, press ENT to Wing Type setting interface. Press UP or DN to move the cursor → to point to Wing Type option, press R or L to choose Normal. Press ENT to confirm and then press EXT to return to Model Menu.

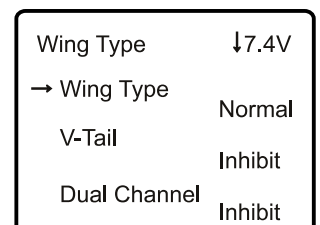

10.2.5 Wing Type

10.2.6 Device Output

Under the Model Menu interface, press UP or DN to move the cursor → to point to Device Output, press ENT to Device Output setting interface.

(1) Gear setting:

Press UP or DN to move the cursor → to point to Gear option, press R or L to choose MIX SW; Press UP or DN to move the cursor → to point to Function setting after you select the switch, press R or L to choose Active.

Device Output	7.4V
Gear	→ MIX SW Active
Flap	GEAR SW Active
AUX2	FMOD SW Active

Device Output	7.4V
Gear	MIX SW → Active
Flap	GEAR SW Active
AUX2	FMOD SW Active

Device Output	7.4V
Gear	MIX SW Active
Flap	GEAR SW → Active
AUX2	FMOD SW Active

Device Output	7.4V
Gear	MIX SW Active
Flap	→ GEAR SW Active
AUX2	FMOD SW Active

(2) Flap setting:

Press UP or DN to move the cursor → to point to Flap item and enter the function setting interface. Press R or L to choose Active. After Active successfully, press UP or DN to move the cursor → to point to Flap switch option, press R or L to choose GEAR SW.

(3) AUX2 Setting:

Press UP or DN to move the cursor → to point to AUX2 option, press R or L to choose FMOD SW; Press UP or DN to move the cursor → to point to Function setting after you select the switch, press R or L to choose Active. After finish settings, press ENT to confirm and then press EXT to exit.

Device Output	7.4V
Gear	MIX SW Active
Flap	GEAR SW Active
AUX2	→ FMOD SW Active

Device Output	7.4V
Gear	MIX SW Active
Flap	GEAR SW Active
AUX2	FMOD SW → Active

10.2.7 Reverse Switch

Press ENT to the Main Menu. Press UP or DN to move the cursor → to point to Function Menu, press ENT to Function Menu; Press UP or DN to move the cursor → to point to Reverse Switch, press ENT to Reverse Switch setting interface; Press UP or DN to move the cursor → to point to desired option, press R or L to change the status between Normal and Reverse. Please see as below. Press ENT to confirm and then press EXT to exit.

Reverse Switch	↓7.4V
→ Elevator	Normal
Aileron	Normal
Throttle	Normal
Rudder	Normal
Gear	Normal

Reverse Switch	↑7.4V
→ Flap	Normal
AUX2	Normal

10.2.8 Video Select

Press ENT to the Main Menu. Press UP or DN to move the cursor → to point to System Menu, press ENT to System Menu; Press UP or DN to move the cursor → to point to Video Select, press ENT to Video Select setting interface. Press R or L to select Active. Press DN to move the cursor → to point to Channel item, press R or L to make the Number change between 1 and 8. With the ILOOK Camera transmitting channel, 1-8 channels could be chosen to receive the image signal. Press ENT to confirm and then press EXT to exit.

Video Select	7.4V
→ Status	Active
Channel	2/8

Video Select	7.4V
Status	Active
→ Channel	2/8



10

Transmitter Setting



10

Transmitter Setting

10.3 DEVO-7(optional radio) setting

10.3.1 Boot Screen

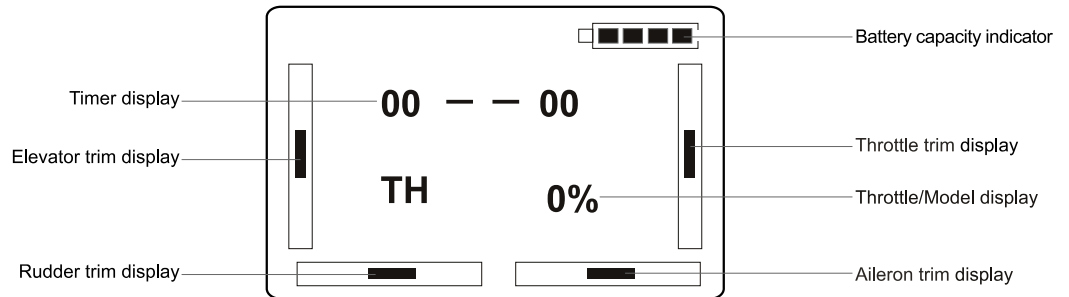

10.3.2 Model Type(TYPE)

Press the ENT button to enter the Main Menu, press UP or DN until MODEL starts to flash, then press ENT button to enter the Model Menu. Press the UP or DN button until TYPE starts to flash. Press the ENT button to choose between Helicopter and Aeroplane types. Press the R or L button to select **AERO**, press ENT to confirm and EXT to go back to the previous menu.

10.3.3 Model Select(SELEC)

Press UP or DN key under the MODEL menu until SELEC starts to flash. Press ENT, the model options will be shown. Press UP or DN to choose MOD 1, press ENT to confirm and EXT back to previous menu.

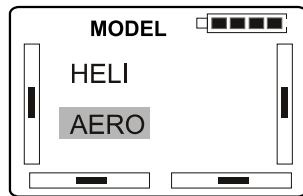

10.3.2 Model Type(TYPE)

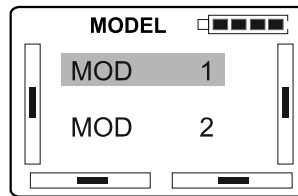

10.3.3 Model Select(SELEC)



10.3.4 Model Name(NAME)

10.3.4 Model Name(NAME)

In the MODEL menu, press UP or DN until the NAME starts to flash. Press ENT to access the model serial No. and default name options. Press UP or DN to select the characters or numbers that you wish to change, use the R or L key to change the characters or numbers to "X350P". Press ENT to confirm and EXT to go back to the previous menu.

10.3.5 Wing Type(WING)

Press the ENT button to enter the MODEL Menu and press UP or DN until WING starts to flash and then press ENT key. The Wing type will be shown. Press UP or DN to choose "NORM" and after setting, press ENT to confirm and EXT to go back to the previous menu.

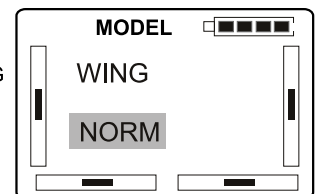

10.3.6 Device Output(OUTPU)

Press UP or DN under the MODEL menu, it comes out the flashing "OUTPU" menu. Press ENT to the submenu of "Output".

(1) GEAR Setting

Press R or L to choose "GEAR MIX"; Press DN and R or L to choose "GEAR ACT".

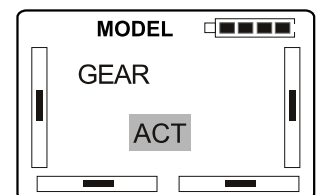
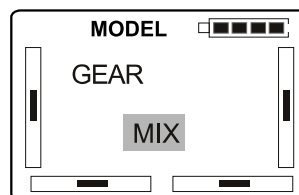

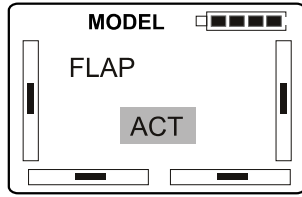
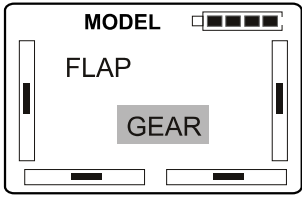

(2) FLAP Setting

Press DN and R or L to choose "FLAP GEAR";
Press DN and R or L to choose "FLAP ACT".

(3) AUX2 Setting

Press DN and R or L to choose "AUX2 FMD";
Press DN and R or L to choose "AUX2 ACT",
and press ENT to confirm. Press EXT to exit
to the main interface.

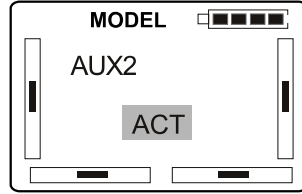
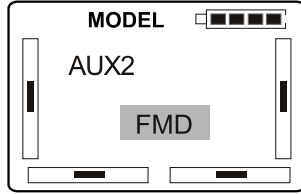

10.3.7 Reverse Switch(REVSW)

Press ENT to enter the Main Menu, press UP or DN until FUNCTION starts to flash, then press ENT to access the function menu. Press UP or DN until REVSW starts to flash. Press ENT to display the channel name and the reverse status. Press R or L to change between NOR and REV settings. Press DN to display each channel AILE, THRO, RUDD, GEAR, FLAP, AUX2 and their corresponding reverse setting. Set each channel as shown in the table below. Once complete, press ENT to confirm and EXT to go back to the previous menu.

ELEV	AILE	THRO	RUDD	GEAR	FLAP	AUX2
NORM	NORM	NORM	NORM	NORM	NORM	NORM

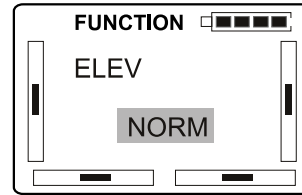

10.4 DEVO-8S/12S(optional radio)settings

- (1) Type: Airplane
- (2) Model Name: QR X350PRO
- (3) Wing type: Normal
- (4) Device Output

DEVO-8S			DEVO-12S		
Gear	MIX SW	Active	Gear	MIX SW	Active
Flap	GEAR SW	Active	Flap	GEAR SW	Active
AUX2	FMOD SW	Active	AUX2	FMOD SW	Active
AUX3	RUDD D/R	Active	AUX3	AUX3 Lever	Active
			AUX4	AUX4 Lever	Active
			AUX5	AUX5 Lever	Active
			AUX6	AUX6 Knob	Active
			AUX7	AUX7 Knob	Active

(5) Reverse switch settings

DEVO-8S	Elevator	Aileron	Throttle	Rudder	Gear	Flap	AUX2	AUX3				
	Normal	Normal	Normal	Normal	Normal	Normal	Normal	Normal				
DEVO-12S	Elevator	Aileron	Throttle	Rudder	Gear	Flap	AUX2	AUX3	AUX4	AUX5	AUX6	AUX7
	Normal	Normal	Normal	Normal	Normal	Normal	Normal	Normal	Normal	Normal	Normal	Normal



10

Transmitter Setting

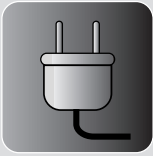

11

Instruction and attention of GA005 balance charger

11.1 Parameters of GA005 balance charger:

Input voltage	Input current	Output current	Dimension	Weight
DC15-18V	1000mA	≤800mA	62.5×47×20.8mm	46g

11.2 Features of GA005 balance charger

- (1) GA005 utilizes microcomputer chips to monitor and control over the whole charging process in a balanced way with LED indicator to display the charging status at real time.
- (2) Connects to an input power supply (DC 15-18V 1000 mA).
- (3) GA005 is suitable for 2-3S (7.4V/ 11.1V) Li-ion or Li-polymer battery pack.
- (4) Automatically detects 2-3S Lithium battery. GA005 will automatically charge when it finds the voltage of anyone cell among the LiPo pack is excessively low. At the same time LED displays as charging status (flash in red). The voltage of anyone cell LiPo is controlled at the level of $4.2 \pm 0.05V$ to ensure the maximum voltage difference of single cell in the battery is less than 50 mV.

11.3 Instruction of GA005 balance charger

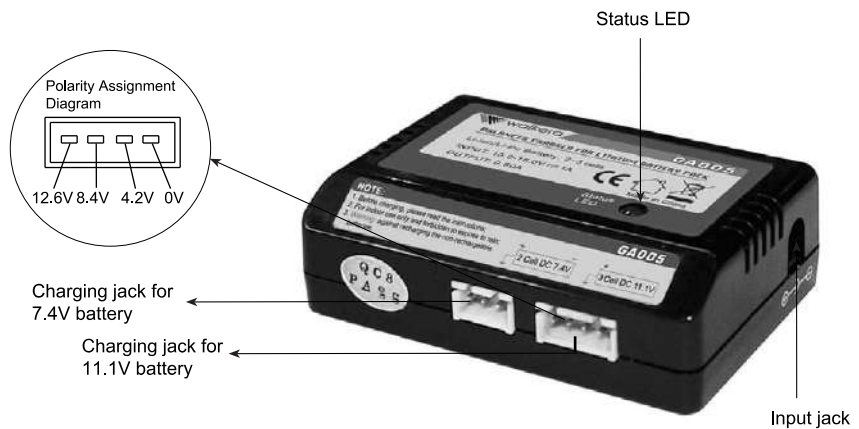

11.4 Operation steps



Plug the wall adapter into the mains power supply. Its output end connects to GA005. Then its LED is lighting in solid red.



Insert the balanced pin of LiPo battery into GA005.



During charging, Red LED is continuously flashing. If saturated, Red LED becomes solid green lighting.

11.5 Charging statuses corresponding to LED

steps	Operation	LED Status	Charging status
1	Insert the wall adapter into the mains power supply, and then its output is connecting to GA005.	LED is in red solid lighting	Power on
2	Step 1 + connect the battery to GA005	LED is flashing in red	Charging
		LED becomes from red to solid green.	Saturated

11.6 Matters needing attention

- (1) During charging, GA005 should be put in dry and ventilated place and be far away from heat sources and inflammable and explosive substances.
- (2) GA005 is only used to charging a 2S or 3S Li-ion or Li-polymer battery. It is forbidden to simultaneously charge two or more sets of batteries packs. Either the charger or battery may be damaged.
- (3) When charging, the battery should be removed from your helicopter. Never leave the charger unsupervised during the process of charging in order to avoid risk of accidents.
- (4) Never immediately charge your battery as soon as the flight is finished, or when its temperature doesn't cool down. Otherwise the battery will take a risk in swelling, even catch a fire.
- (5) Ensure the correctness of polarity before connecting the battery to charger.
- (6) Avoid drop and violence during the process of charging. Drop and violence will result in internal short circuit of the battery.
- (7) For the sake of safety, please use original charging equipment (wall adapter + GA005 balance charger) and battery pack. Please change new one in time when the old battery is becoming swollen due to long time usage.
- (8) If it is retained in the charger for a long time after saturated, the battery may automatically discharge. When the charger detects that the voltage of individual cells is lower than the rated voltage, it will re-charge until saturated. Frequently charging and discharging will shorten the lifetime of your battery.

11.7 Maintenance of battery pack

- (1) The battery should be put in dry and ventilated place. The storage temperature of the environment is ranged from 18°C to 25°C.
- (2) Please avoid frequent charging and excessive discharging the battery in order to prolong its life cycle.
- (3) It is a must to maintain the battery before long-term storage. That is to charge the battery to the level of 50-60% saturation.
- (4) If the storage term is over 1 month, it is advised to monthly check the voltage of every cell of the battery . The voltage of every cell should be not less than 3V. Otherwise, please refer to the above article (3).
- (5) From the view point of protection, new battery should be motivated before usage. That is to charge and discharge 3-5 times, but discharge is not less than the level of 70% saturation. This process will make the battery lifetime longer and voltage more stable.

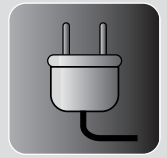

11

Instruction and attention of GA005 balance charger



12

Steps of flight

<p>Step 1</p>	<p>Step 2</p>	<p>Step 3</p>	<p>Step 4</p>
<p>Step 1: Open the battery compartment, install the battery pack into the battery compartment along the arrow direction.</p>		<p>Step 2: Turn on the power of transmitter.</p>	
<p>Step 3: Pull down the throttle stick of transmitter to the lowest position, and then move the throttle trim, elevator trim, aileron trim, and rudder trim at the neutral positions, respectively.</p>		<p>Step 4: Connect the power cable of the Aircraft and wait to receive the signal from the transmitter. The Aircraft should be placed on flat ground or surface during code pairing (binding). Do not move the transmitter sticks or the Aircraft until binding has completed.</p>	



13

Flight over

<p>Step 1</p>	<p>Step 2</p>	<p>Step 3</p>
<p>Step 1: disconnect the power cable of Aircraft .</p>	<p>Step 2: turn off the transmitter.</p>	<p>Step 3: take off the battery pack.</p>



Appendix 1 – Manual flight control

Mode 1 (throttle stick on the right hand)

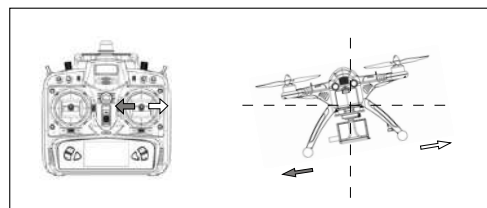

1. When moving the aileron stick left or right, the Aircraft accordingly flies left or right.

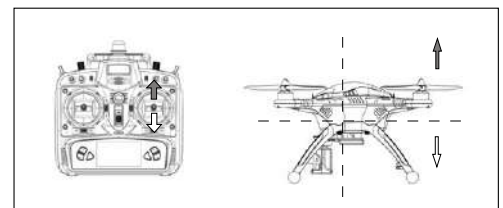

2. When moving the throttle stick up or down, the Aircraft accordingly flies up or down.

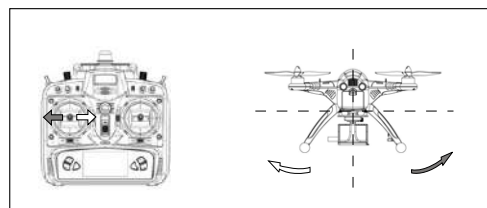

3. When moving the rudder stick left or right, the head of Aircraft accordingly rotates to the left or right.

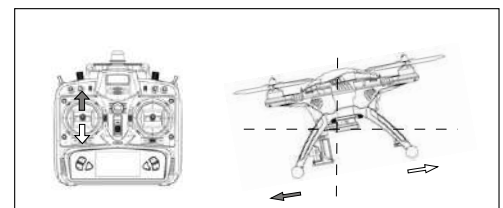

4. When moving the elevator stick up or down, the Aircraft accordingly flies forward or backward.

Mode 2 (throttle stick on the left hand)

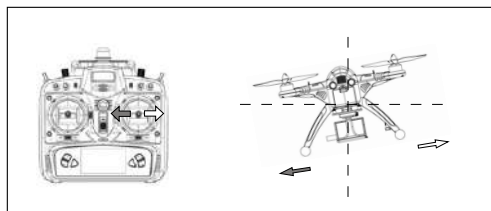

1. When moving the aileron stick left or right, the Aircraft accordingly flies left or right.

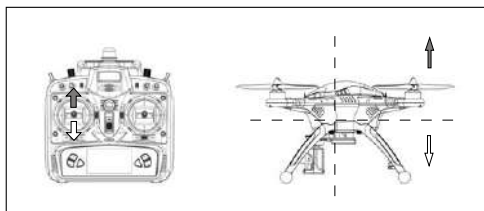

2. When moving the throttle stick up or down, the Aircraft accordingly flies up or down.

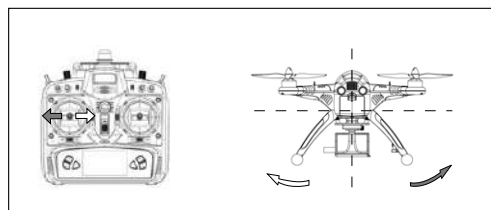

3. When moving the rudder stick left or right, the head of Aircraft accordingly rotates to the left or right.

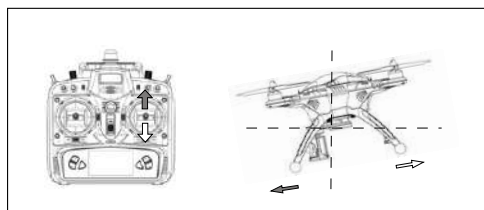

4. When moving elevator stick up or down, the Aircraft accordingly flies forward or backward.

(1) Adjust the rudder trim



Move the rudder trim right if the head of Aircraft flies leftward during taking off; otherwise move the rudder trim left.

(2) Adjust the elevator trim



Move the elevator trim down if the Aircraft flies forward during taking off; otherwise move it up.

(3) Adjust the aileron trim



Move the aileron trim right if the Aircraft flies leftward during taking off; otherwise move it left.



Appendix 1 – Manual flight control



Appendix 2 – Trimming the Manual flight actions



The specifications of the R/C aircraft may
be altered without notice.



Add.: Taishi Industrial Park, Dongchong Town
Panyu District, 511475 Guangzhou

Tel.: (8620) 8491 5115 8491 5116

Fax.: (8620) 8491 5117

Web.: www.walkera.com

Email.: heli@walkera.com
info@walkera.com