

# ***RUNNER 250*** PRO

## QUICK START GUIDE **V1.1**

24th-NOV-2016

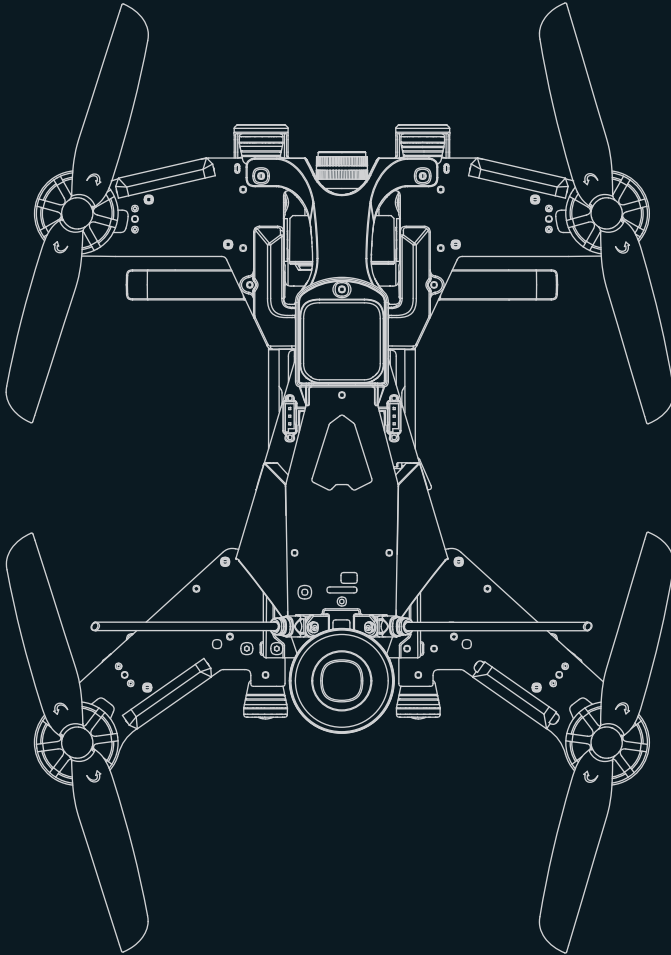

# Contents

1.0 Get to know your aircraft	3
2.0 Get to know your Remote Controller	4
3.0 Specifications	5
4.0 Attention before Flying	6
5.0 Charge the Battery	6
6.0 Prepare the Remote Controller	6
7.0 Prepare the aircraft	7
8.0 Ready to Fly	8
8.1 Starting the aircraft / Get binding	8
8.2 GPS indicator lights	9
8.3 Motor Unlock / Lock	9
9.0 Operation Instruction	10-12
10.0 End Flying	12
11.0 Additional remarks	13
11.1 DEVO 7 Remote Controller Setting	13-14
11.2 TX5834(FCC)/TX5835(CE) Video transmitting channel selection	15
11.3 OSD interface information Introduction	15
11.4 Introduction for FCS-250 Main Flight Controller	16
11.5 Introduction for DEVO-RX717 receiver	16
11.6 Brushless ESC and Brushless Motor connection diagram	16
11.7 Compass Calibration	17
12.0 Camera(1920x1080P) Instructions	18
13.0 Instructions for GA005 balance charger	19

## 1.0 Get to know your aircraft

- The RUNNER 250 body is created using CFP for outstanding crash survivability.
- Modern industrial and modular design, improves the product performance and permit easy maintenance and upgrades.
- Advanced 5.8ghz live video and OSD system, for a unforgettable visual FPV experience.
- Equip with dual GPS module, the RUNNER 250 advance can realize GPS hold mode, Circle Flight, Hyper IOC and one key return to home.

1. Camera
2. Lighting Lamp x2
3. Landing gear x4
4. Clockwise motor (levogyrate thread is counterclockwise)

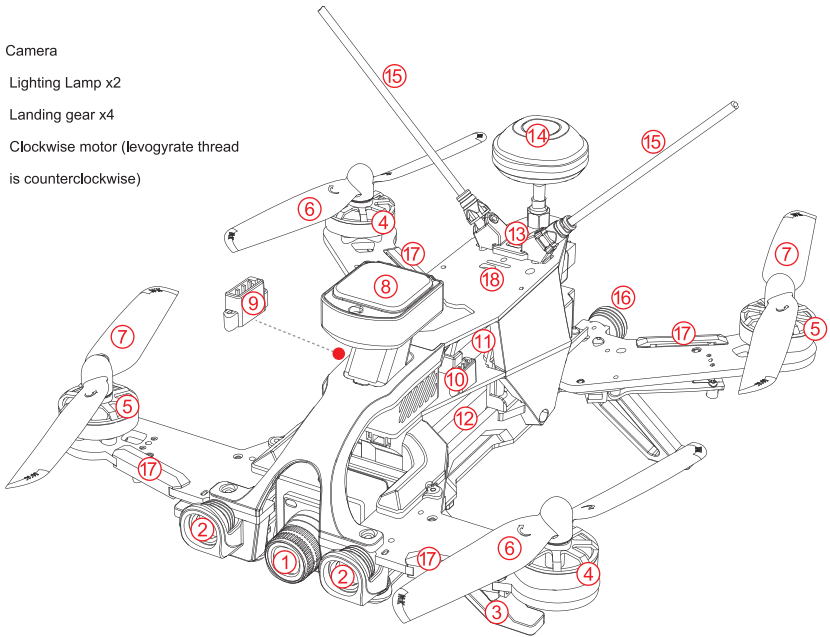

- |  |   |
|--|---|
| <ol style="list-style-type: none"> <li>5. Counterclockwise motor (dextrogyrate thread is clockwise)</li> <li>6. Clockwise propeller</li> <li>7. Counterclockwise propeller</li> <li>8. GPS</li> <li>9. SBUS/PPM connection port</li> <li>10. 5V power output port</li> <li>11. FCS-250 Main Controller</li> <li>12. Battery: 11.1V 2200mAh 25C 3S Li-Po</li> </ol> | <ol style="list-style-type: none"> <li>13. Transmitter code switch</li> <li>14. Mushroom antenna</li> <li>15. DUAL reciever antennas for best performance<br/>* always extend before flying</li> <li>16. Red LED light x2</li> <li>17. Turn indicator light x4</li> <li>18. OSD code switch:</li> </ol> |
|--|---|



Slide the code switch "1" to "ON" to start the OSD

\* To avoid property loss and personal injury caused by wrong operation, please read the manual carefully and watch the tutorial videos at [www.walkera.com](http://www.walkera.com) before flight.

## 2.0 Get to know your Remote Controller

Equipped with the Manual Mode / GPS hold mode / one key return to home / Circle Flight / Hyper IOC, camera controlling switches, the RUNNER 250 is easier to control.

(You can select suitable flight mode according to your flying skill.)

1. HOLD TRN switch
2. GEAR switch - Camera start/Stop
3. AUX2 control
4. Left stick
5. Left trim
6. RUDD trim
7. UP+ key
8. DN- key
9. EXT key
10. FMOD - Flight Mode Switch
11. MIX - Control Mode Switch
12. ELEV/AILE/RUDD D/R Switch
13. Right stick
14. Right trim
15. Power switch
16. AILE trim
17. R+ key
18. L- key
19. ENT key

Manual Mode	GPS-hold Mode	Return TO Home
MIX Switch to "0"	MIX Switch to "1"	MIX Switch to "2"

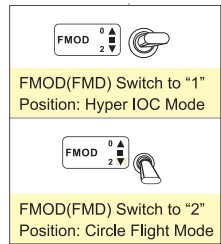
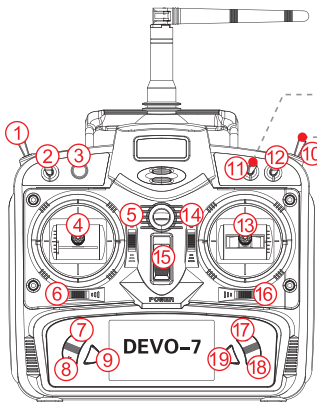

Take the "MODE 2 (Throttle stick on the left)" as an example. The left stick controls the aircraft's altitude and heading, while the right stick controls its forward, backward, left and right movements.

### Left Stick

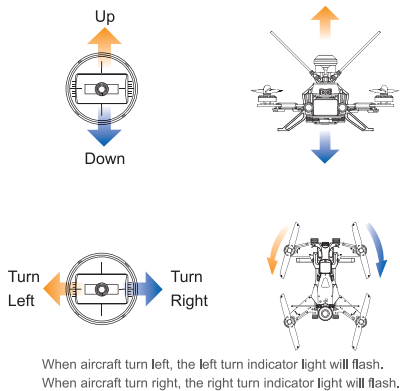

### Right Stick

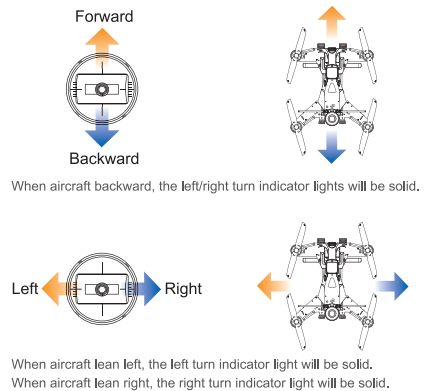

- \* 1) MODE 2 (Throttle stick on the left): Left stick- THRO / RUDD; Right stick - ELEV / AILE.
- 2) MODE 1 (Throttle stick on the right): Left stick- ELEV / RUDD; Right stick - THRO / AILE.

### 3.0 Specifications

• Aircraft

Main Rotor Dia.: 143mm  
 Overall (L x W x H): 221 x 205 x 117mm  
 Weight: 464g (Battery excluded)  
 Remote Controller: DEVO 7  
 Receiver: DEVO-RX717  
 Main Controller: FCS-250  
 Transmitter: TX5834(FCC)/TX5835(CE) (OSD included)  
 Brushless Motor: WK-WS-28-014A(CW/CCW)  
 Brushless ESC: F210 ESC  
 Battery: 11.1V 2200mAh 25C 3S LiPo  
 Flight Time: 10~12mins  
 Working Temperature: -10 C ~ +40 C

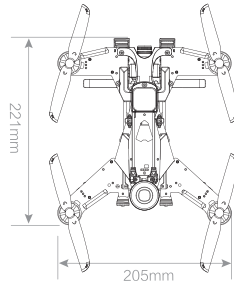
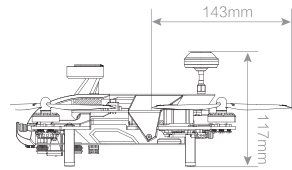

• Camera(800TVL)

Horizontal Resolution: 800TVL  
 System Committee: PAL/NTSC  
 Video Out: 1.0Vp-p/75Ω  
 Power Input: DC 12V

• Camera (1920 x 1080P)

Video Resolution: 1920x1080P 60FPS  
 Micro SD card: Max 32G  
 Video Format: MOV  
 Photo: 4000x3000 Pixels  
 Photo Format: JPG  
 Power Input: DC 5V

• DEVO 7 remote controller

Frequency: 2.4GHz DSSS  
 Output Power: ≤100mW  
 Current drain: ≤230mA(100mW)  
 Power Supply: 5# Battery 8x1.5V or NiMH 8x1.2V 1600-2000mAh  
 Output Pulse: 1000-2000mS(1500Ms Neutral)

• TX5834(FCC) / TX5835(CE) transmitter

5.8G wireless image transmission  
 TX5834(FCC) Bind B section: 8 channels  
 TX5835(CE) B section: 8 channels  
 TX5834(FCC) output power ≤200mW  
 TX5835(CE) output power ≤25mW

## 4.0 Attention before Flying

- 1) The RUNNER 250 is recommended for pilots, 14 years or older, with RC hobby experience.
- 2) Only fly the RUNNER 250 in dry weather, with low wind, please do not fly in rain or heavy foggy conditions.
- 3) Always choose large open fields for flying. Check local LAW and ordinances for legal flying areas.
- 4) Always keep at least 10 feet distance to the aircraft when armed, to avoid injury from high-speed propellers on the ground or while flying. Always disarm before handling the aircraft.
- 5) Do not fly close to high-voltage power lines, cellphone towers, or radio towers, as these may disrupt your control signal.
- 6) ALWAYS check local laws BEFORE flying. NEVER fly over crowds, concerts or sports stadiums.

## 5.0 Charge the Battery

- ① Insert the power adapter(100~240V 50/60HZ), connect the output end to the GA005 balance charger, the balance charger is red LED at this time.
- ② Insert the battery charging terminal into 3 Cell DC 11.1V charger socket.
- ③ During charging, Red LED is continuously flashing. If saturated, Red LED becomes solid green lighting.



Attention:

- Please refer to Page 19 for details of GA005 balance charger.

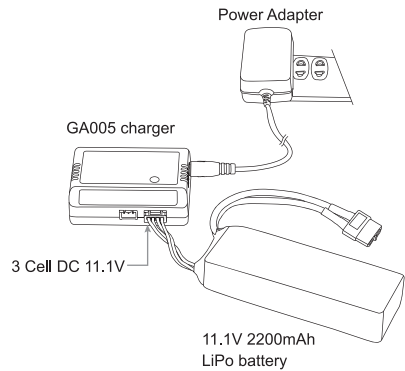

## 6.0 Prepare the Remote Controller

Open the battery cover and remove the battery box. According to the battery positive and negative polarity, install 8pcs 5# batteries or 8pcs NiMH batteries with same volume.

### Warning:

**Battery polarities must be correctly installed.**  
**When insert the plug of battery box into power socket of remote controller, the fool-proofing port must be inserted into fool-proofing port.**

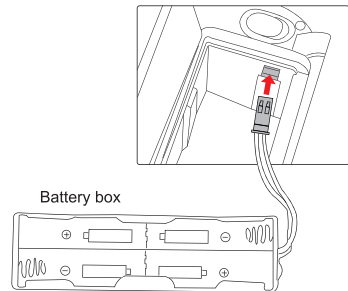

## 7.0 Prepare the aircraft

### Install 5.8G antenna

Firstly install 5.8G antenna onto the transmitter, and tighten with open-end wrench.

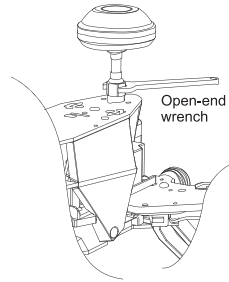

### Install propellers

Fix the CW propeller(↻) onto the CW motor according to the direction of blue arrow, and fix the CCW propeller(↻) onto the CCW motor according to the direction of orange arrow.

Tighten the propellers manually and make sure the propeller is installed in proper way and fastened.



**Attention:**

- Install prop by hand and tighten by holding the motor with the included wrench. You can also use the wrench to help remove broken props in case of a crash.

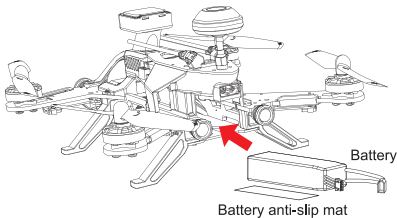
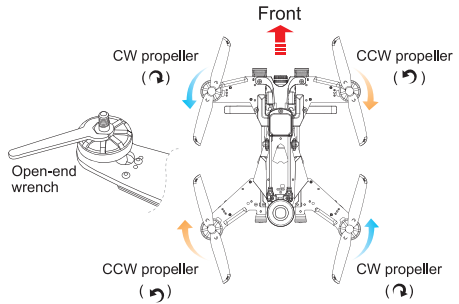

### Battery installation

Put the battery and the Battery anti-slip mat into the RUNNER 250, balance the gravity, keep the head and the tail parts aligned, then fasten the battery with the Velcro strap.

### Gravity center adjustment

Grab the RUNNER 250 by the COG line (center of gravity). See the illustration for the COG. Adjust the battery forward-backwards until the quad balances.

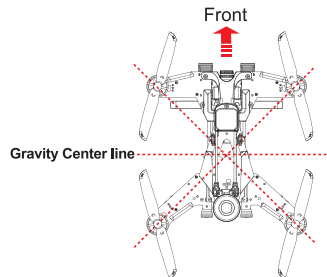

## 8.0 Ready to Fly



Attention:

- Place the aircraft in a wide open space, with the rear facing you. (This position is known as "TAIL IN")
- Put all the function switches to the 0 position, put all trims and dials to the Middle position, move the throttle to the lowest position, then turn on the Remote Controller.
- A video receiving equipment is needed( such as Goggles glasses, etc. ) to display an image and OSD information. (Setting method please refer to P15)
- The RUNNER 250 have a low-voltage alarm beeper. And the OSD give you a visual reference for the remaining battery power. When voltage reach below 10.8 volts the LEFT red LED lights will flash slowly and the beeper will sound alarm.  
**WARNING:** Do not hesitate to land when you hear the alarm or see the OSD indicating 10.8 volts.

## 8.1 Starting the aircraft / Get binding

- ① Turn on the Remote Controller. (Make sure all the function switches, all trims/knobs and throttle stick at the lowest position)

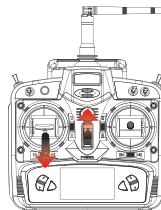

- ② Put the aircraft to the horizontal place and connect the aircraft power. (make sure the positive and negtive connected correctly)

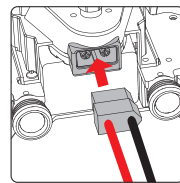

- ③ The red LED light on the left of aircraft flashes slowly until goes out, indicating that the IMU preheating is complete and the code binding is successful. If it issuing the sound of "BB" that it is fail to IMU preheating. Pls restart the aircraft.



Tips:

- Do not move the aircraft during start-up.
- ALWAYS unfold the two reciever anteenas to their correct STRAIGHT UP position before flying. Do not fly without properly unfolding the antennas.

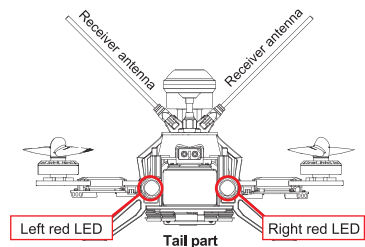



## 8.2 GPS indicator lights

When the right red LED light (GPS) begin to flash, you can work GPS function.

## 8.3 Motor Unlock / Lock

### Motor Unlock

After the success of IMU preheating, Check that all trims are neutral, the throttle stick is ALL the way Down with the display indicating 0% throttle. Check that ALL switches are in the UP position.

Gently push the throttle stick down and move the rudder (YAW) stick to the left side and hold for more than 2 seconds. (on mode 2 radios throttle and rudder is the same stick).

You will see the left red LED light keeps on, indicating that motors are unlocked.

Be very careful at this point, as pushing the throttle up will start the motors.

You can test by pushing the stick up a little, the motors should start.

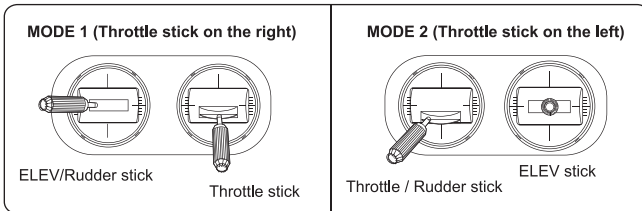

### Motor Lock

Gently push the throttle stick down and move the rudder (YAW) stick to the right side and hold for more than 2 seconds. (on mode 2 radios throttle and rudder is the same stick)

You will see the left red LED light turns off, indicating that motors are locked.

**TEST:** Push the throttle stick up a little, the motors will not start when locked.

**NOTICE:** The motors are LOCKED by default after successful binding.

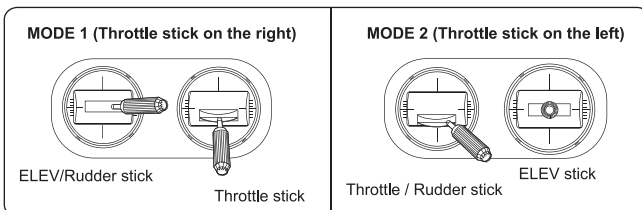

## 9.0 Operation Instruction

Please unlock the motor before start flying, then take off in manual mode(push up the throttle).

### GPS hold mode

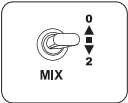

MIX switch  
to "1" position

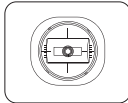

Throttle stick  
return neutral

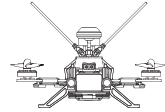

Ground

#### Attention:

- 1) Make sure that the received GPS signal (RIGHT red LED light blinks).
- 2) In the GPS mode, there are Altitude hold, fixed point, brake function, the flight speed is slower ( $\leq 5m/s$ ).
- 3) If the GPS signal is poor or no signal, can only be Altitude hold, but not fixed point.
- 4) Switch to manual mode can not be fixed point.

### Circle flight

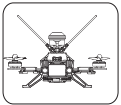

Aircraft in  
GPS hold mode

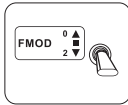

FMOD(FMD) switch  
to "2" position

#### Attention:

- 1) Make sure that the received GPS signal (RIGHT red LED light blinks).
- 2) The aircraft is under quiescent state when it enters auto-circling. The circling function can only work after you set circle speed and direction by **toggle aileron stick left or right** (-5m/s to +5m/s speed changeable, Default is 0m/s).

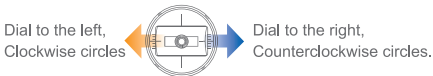

Speed: The larger volatility toggling and longer holding time, the faster circling. The slower the contrary.

- 3) **Dial elevator stick up or down** to change circle radius (5m-50m radius changeable, Default is 5m)

Dial up, Circle radius turns small

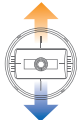

Dial down, Circle radius turns large

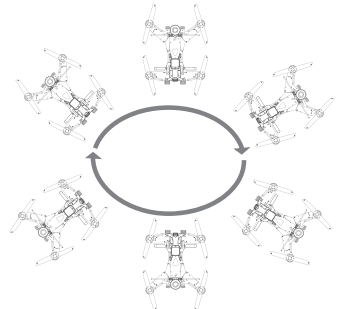

**RETURN TO HOME**

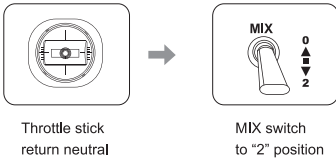

**Aircraft with Home point horizontal distance > 30m**

- a. If the flight altitude is higher than 25m, the aircraft will keep the current altitude and return above the Home Point then descend vertically.
- b. When the flight altitude is lower than 25m, the aircraft will elevate automatically to 25m high then fly back above the Home Point and land vertically.

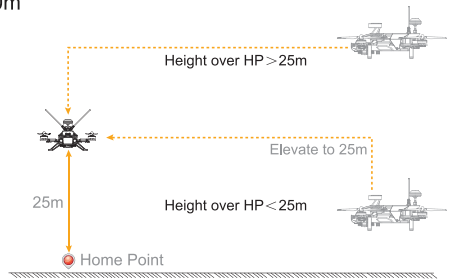

**Aircraft with Home point horizontal distance < 30m**

- a. If the flight altitude is higher than 25m, the aircraft will keep the current altitude and return above the Home Point then descend vertically.
- b. If the flight altitude is lower than 25m, the aircraft will keep the current altitude and return above the Home Point then descend vertically.

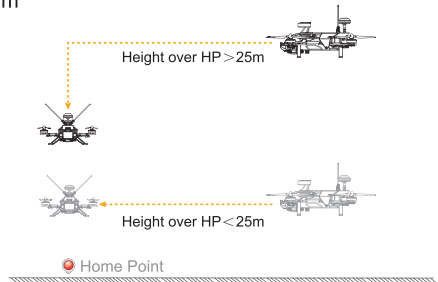

**Attention:**

- 1) Make sure that the received GPS signal (RIGHT red LED light blinks).
- 2) To enter a key return, please don't move the other switches and buttons.
- 3) When the aircraft lost the remote controller signal, it will automatically enter Failsafe RTH.
- 4) When the aircraft battery voltage is less than 10.8V, and aircraft with Home point horizontal distance is greater than 8m, aircraft will automatically turn back. If the aircraft with the Home point horizontal distance less than 8m, aircraft will decrease automatically from the current position and land.
- 5) GPS signal is not normal or GPS does not work, can not achieve the auto return, but will land automatically.

## Hyper IOC Mode

IOC or Intelligent Orientation Control mode means that the aircraft's flight direction is only relative to the original take-off point (where you armed the motors). REGARDLESS of the actual aircraft heading, in this mode you can fly past something and pan the aircraft to frame your shot, without having to worry what direction the aircraft is facing.

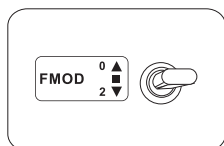

FMOD (FMD) switch to "1" position

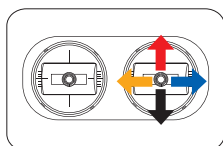

Mode2 (Throttle stick on the left)

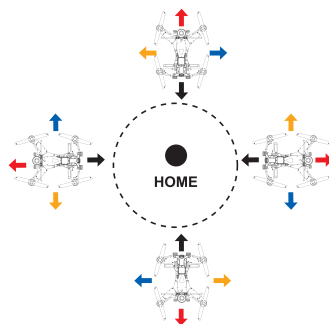

### Attention:

- 1) Make sure that the received GPS signal (RIGHT red LED light blinks)
- 2) IOC is inactive if the RUNNER 250 is less than 10 meter (30 feet) from the original take-off position. (point where you armed the motors)  
Fly the RUNNER 250 manually beyond 10 meters using the GPS mode, then activate the IOC mode, the RUNNER 250 will now fly IOC until you change the mode, you can pan freely for video shots, when you push the stick right or left, the RUNNER 250 will move sideways relative to the original take-off position. Pushing the pitch stick up will push the RUNNER 250 away from you, pulling the stick back brings the RUNNER 250 back to the starting point. When flying in IOC mode, you can make the RUNNER 250 return to the starting point simply by pulling the stick toward you.

**WARNING:** The IOC turns off when the aircraft gets closer than 10meters to the take off point. Be prepared for this, as the system will switch back to GPS hold mode at that point. This switch can cause confusion if the pilot are not prepared.

## DERAM Baron AKA Proximity FPV obstacle flying

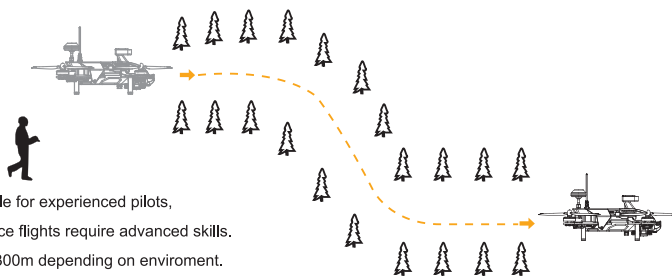

### Attention:

- 1) Dream Baron is more suitable for experienced pilots, highspeed obstacle avoidance flights require advanced skills.
- 2) Recommended FPV range 300m depending on enviroment.
- 3) Avoid flying over people, animals, do not fly over crowds, concerts or sports stadiums. Avoid flying close to powerlines and cellphone towers as these may crash you.  
Visit [walkera.com](http://walkera.com) for more suggestions and for WALKERA racing gates.

## 10.0 End Flying

- ① Manual landing or return to home function landing.
- ② First Power off the aircraft by unplugging the battery, then turn off the radio.
- ③ Finally, remove the battery from the aircraft.

## 11.0 Additional remarks

### 11.1 DEVO 7 Remote Controller Setting

#### Boot Screen(Main interface)

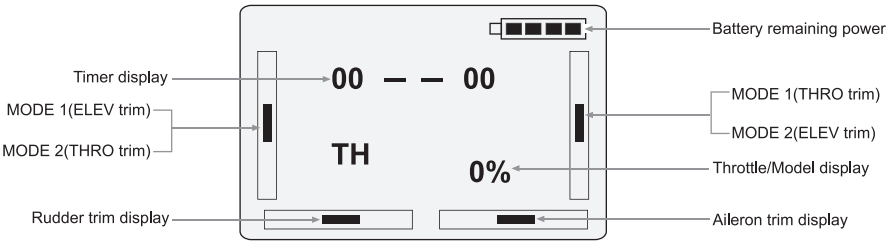

#### SELEC

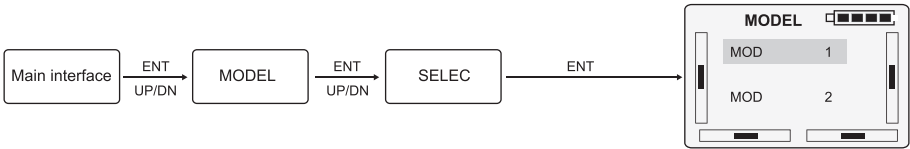

Press UP or DN to select "MOD 1", press ENT to confirm and then press EXT to return to MODEL.

#### NAME

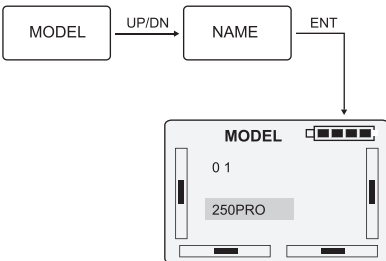

Press R or L button to change the character and figure, named model as 250PRO. Press ENT to confirm and then press EXT to return to MODEL.

#### TYPE

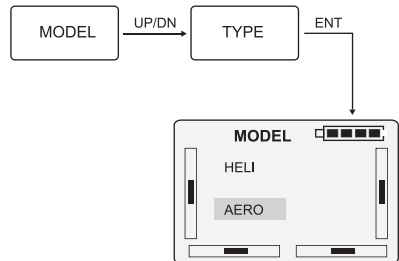

Press UP or DN to select AERO, Press ENT to confirm and then press EXT to return to MODEL.

### WING

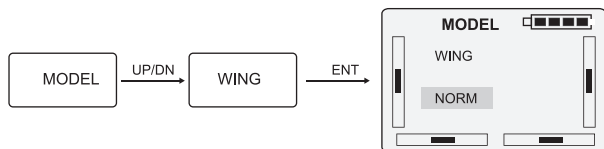

Press R or L to select NORM, Press ENT to confirm and then press EXT to return to MODEL.

### OUTPUT

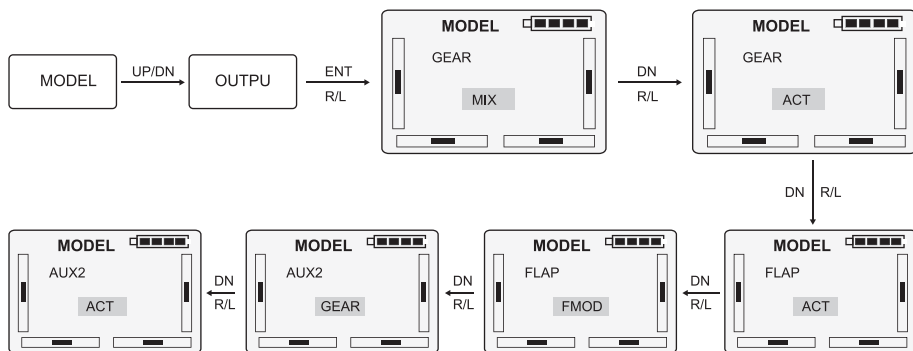

After setup, press ENT to confirm and then press EXT to return to Main interface.

### REVSW

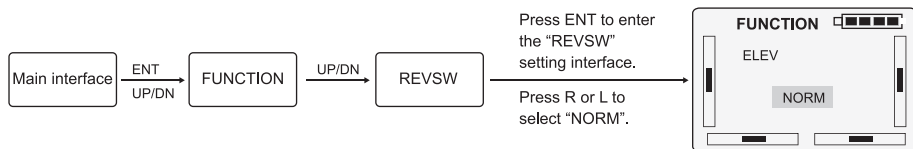

Press ENT to enter the "REVSW" setting interface.  
Press R or L to select "NORM".

ELEV	AILE	THRO	RUDD	GEAR	FLAP	AUX2
NORM	NORM	NORM	NORM	NORM	NORM	NORM

After settings, press ENT to confirm and then press EXT to return to Main interface.

## 11.2 TX5834(FCC)/TX5835(CE) Video transmitting channel selection

### Port introduction

1. Position of 5.8G antenna
2. Transmitter code switch
3. OSD code switch

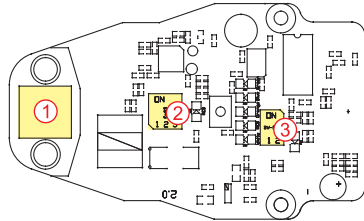

### Video transmitting channel selection

There are 8 channels available, chose the best channel based on the image quality on your screen. Select the channel by adjusting the dip-switches on the video-transmitter according to the diagram.

Channel	1	2	3	4	5	6	7	8
Frequency	5866MHz(CE) 5847MHz(FCC)	5847MHz	5828MHz	5809MHz	5790MHz	5771MHz	5752MHz	5733MHz
Code position (on/off)								



**Attention:**

- Video transmitter channel must match the reciever channel.

## 11.3 OSD interface information Introduction

**The OSD information is visible on your video reciever.**

**\* Goggles or screen with video reciever.**

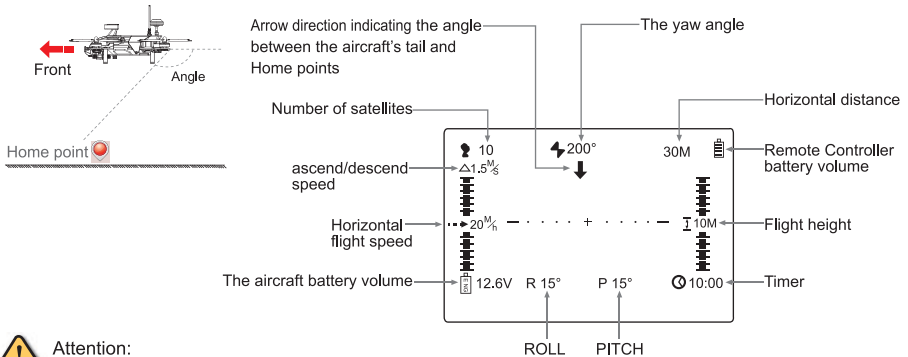

**Attention:**

- When the arrow points straight down, pull back the ELEV stick, then the drone will fly back to Home position.
- OSD code switch from "1" to "ON" to start the OSD.

## 11.4 Introduction for FCS-250 Main Flight Controller

### Flexible flat cable connection

The metal surface of flexible flat cable plug should be inserted upward to main controller port properly.



The metal surface of flexible flat cable plug should be inserted downward to power board port properly.

### Port introduction

1. GPS Port: connect GPS module
2. USB port: used for upgrading and setting parameter
3. Connection port: used to connect flexible flat cable

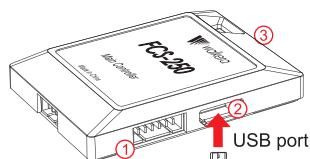

### Upgrading

Please upgrade online via Walkera official website

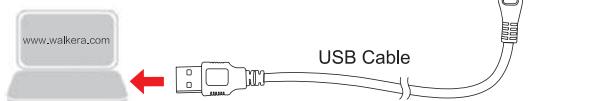

## 11.5 Introduction for DEVO-RX717 receiver

### Fixed ID Code - clearing method

If you want to clear the fixed-ID, after having set a fixed-ID from the remote controller, Press the CLEAN button and power the RUNNER 250, when successful, the receivers RED LED will blink slowly to indicate the fixed-ID have been cleaned. Make sure you set the Remote Controllers fixed-ID setting to OFF. (to set a fixed-ID, please refer to the remote controller manual)

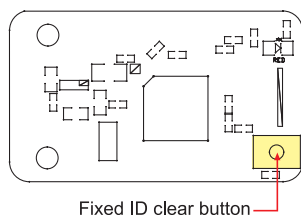

## 11.6 Brushless ESC and Brushless Motor connection diagram

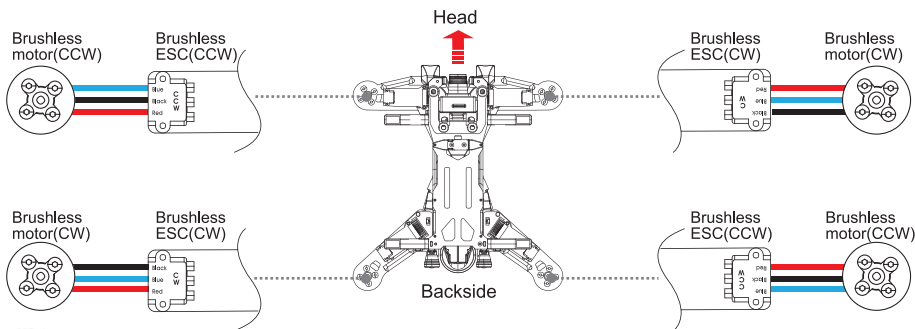

### Attention:

- The three lines red, blue and black in brushless motor must be connected to brushless ESC according to the photo above.



## 11.7 Compass Calibration



Attention:

- If there is circles or drift in flying, please calibrate the compass.  
(the motor must be locked and LEFT red LED light go out )
- Please calibration outdoors and far away from strong electromagnetic interference.

The compass calibration steps are as follows:

- ① Do this by moving both sticks DOWN and to the middle position at the same time about 5 seconds, the aircraft left red LED light flash quickly, right red LED light turn off.

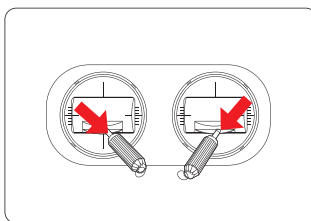

- ② Rotate the aircraft 360 degrees in the horizontal direction until the left red LED light flash quickly, right red LED light brighting.

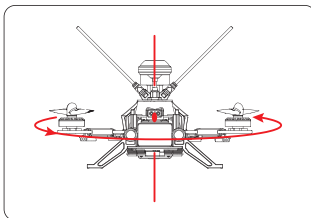

- ③ Rotate the aircraft in the vertical direction (aircraft head down) 360 degrees until both left red LED and right red LED light turn off, which indicates that the calibration is successful, and then the aircraft is still in the horizontal position.  
If calibration is not successful, please re calibrate it according to the above methods.

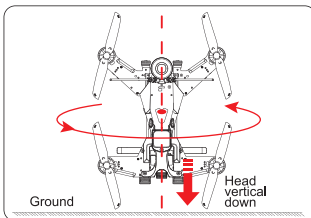

## 12.0 Camera(1920x1080P) Instructions

### 💡 Tips:

- A Micro SD card must be inserted into the camera before power on and removed after power off. (A high speed SD card is recommended.)
- Insert the Micro SD card, after the camera power on, the red indicator will keeps solid.

### 12.1 Pictures illustration

1. Shutter Button
2. Red Indicator
3. Power port(DC 5V)
4. Video/Photo Switch
5. Micro SD card slot

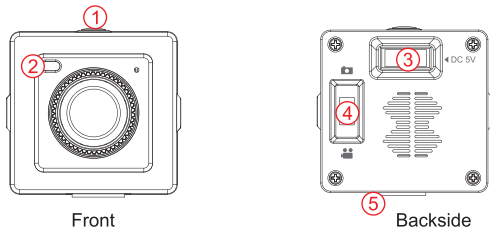

### 12.2 Video instruction

#### Manual Operation

Turn the Video/Photo Switch to , press the shutter button once to start recording (the Red indicator flashes for 0.5sec interval); Press the shutter button again to stop recording (The Red indicator keeps solid).

#### DEVO 7 Remote Controller Operation

- ① Please turn the video/photo switch to “” position.
- ② **Start video:** turn the **GEAR switch** from “0” position to “1” position, wait for 1-2 seconds, then return to the “0” position, the camera will start recording (**the red indicator keeps flashing with an interval of 0.5 second**).

**Stop recording:** turn the **GEAR switch** from “0” position to “1” position, wait for 1-2 seconds, then return to the “0” position, the camera will stop recording (**the red indicator keeps solid red**).

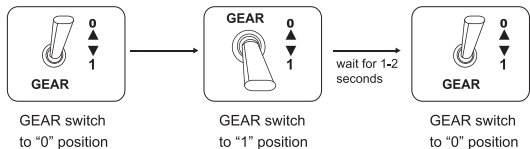

### ⚠ Attention:

- You must stop recording to store the video on the SD card. The video will not be stored if you turn off the power before stopping the recording.

### 12.3 Photo instruction

#### Manual Operation

Turn the video/photo switch to , press the shutter button once, camera will take a photo (the red indicator light out once then keeps solid red), press the shutter button again, it will take another photo.

#### DEVO 7 Remote Controller Operation

- ① Please turn the video/photo switch to “” position.
- ② Turn the **GEAR switch** from “0” position to “1” position, wait for 1-2 seconds, then return to the “0” position, the camera will start to take a photo (the red indicator light out once then keeps solid red), operate again to take another photo, and so on.

## 13.0 Instructions for GA005 balance charger

Parameters of GA005 balance charger

Input voltage	Input current	Output current	Dimension	Weight
DC15-18V	1000mA	≤800mA	62.5 x 47 x 20.8mm	46g

Features of GA005 balance charger

- 1) GA005 utilizes microcomputer chips to monitor and control over the whole charging process in a balanced way with LED indicator to display the charging status at real time.
- 2) Connects to an input power supply (DC 15-18V 1000 mA).
- 3) GA005 is suitable for 7.4V/ 11.1V Li-ion or Li-polymer battery pack.
- 4) GA005 can detect Li-Po battery automatically. GA005 will automatically charge when it finds the voltage of single cell battery is excessively low. At the same time LED displays as charging status (flash in red).  
Control single cell battery voltage at the range of  $4.2 \pm 0.05V$  to ensure the maximum voltage difference of single cell in the battery is less than 50 mV.

Instruction of GA005 balance charger

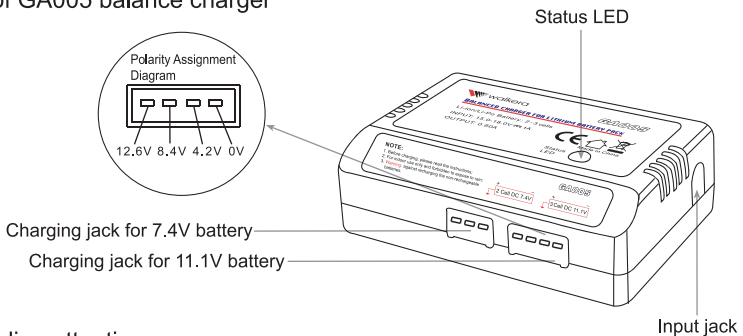

Matters needing attention

- 1) GA005 is only used to charging a 2S or 3S Li-ion or Li-polymer battery. It is forbidden to simultaneously charge two or more sets of batteries. Either the charger or battery may be damaged.
- 2) During charging, GA005 should be put in dry and ventilated place and be far away from heat sources and inflammable and explosive substances.
- 3) When charging, the battery should be removed from your helicopter. Never leave the charger unsupervised during the process of charging in order to avoid risk of accidents.
- 4) Never immediately charge your battery as soon as the flight is finished, or when its temperature doesn't cool down. Otherwise the battery will take a risk in swelling, even a fire.
- 5) Ensure the correctness of polarity before connecting the battery to charger.
- 6) Avoid drop and violence during the process of charging. Drop and violence will result in internal short circuit of the battery.
- 7) For the sake of safety, please use original charging equipment (wall adapter + GA005 balance charger) and battery. Please change new one in time when the old battery pack is becoming swollen due to long time usage.
- 8) If it is retained in the charger for a long time after saturated, the battery may automatically discharge. When the charger detects that the voltage of individual cells is lower than the rated voltage, it will re-charge until saturated. Frequently charging and discharging will shorten the lifetime of your battery.



 Tel: 400-9318-878

User manual is subject to change without prior notice.

Please go to Walkera official website to get the latest version.

