

VOYAGER 4 5.8G

DEVO F8W Remote Controller

QUICK START GUIDE V1.2

Oct. 18th, 2018

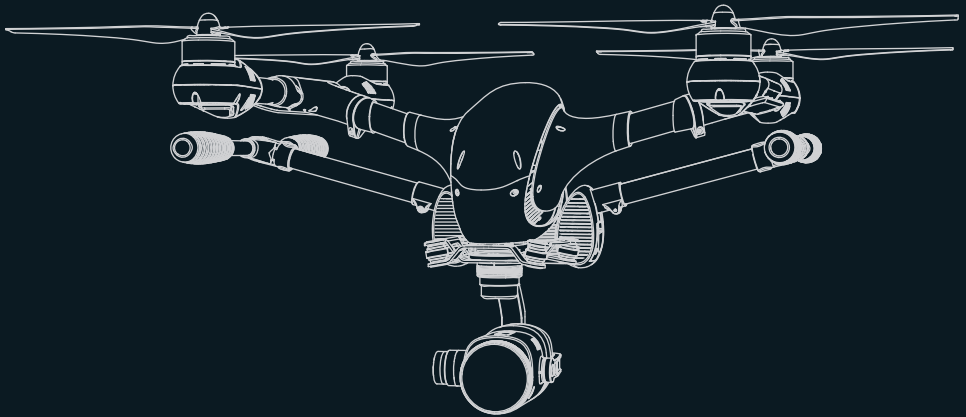

Contents

- 1.0 Get to know your aircraft ----- 3
- 2.0 Get to know your Remote Controller ----- 4
- 3.0 Specifications ----- 5
- 4.0 Attention Before Flight ----- 6
- 5.0 Check Battery Levels ----- 6
- 6.0 Charge the Batteries ----- 6
- 7.0 Downloading and Installing APP ----- 7
- 8.0 APP Interface Instructions ----- 7-8
- 9.0 Prepare for Remote Controller ----- 8
- 10.0 Prepare the VOYAGER 4 ----- 9
- 11.0 Ready for Flight
 - 11.1 Starting the aircraft / Get binding ----- 10
 - 11.2 Connect the APP ----- 10
 - 11.3 GPS Indicator Lights ----- 11
 - 11.4 Motor Unlock / Lock ----- 11
- 12.0 Flight Control ----- 12-16
- 13.0 End flight ----- 17
- 14.0 Additional remarks
 - 14.1 Compass Calibration ----- 17
 - 14.2 Introduction for FCS-V4 Main Flight Controller ----- 17
 - 14.3 Stick Mode Switch, Stick Calibration and Customize Fixed ID ----- 18
- 15.0 Intelligent Flight Battery Safety Guidelines
 - 15.1 Battery Use ----- 19
 - 15.2 Battery Maintenance ----- 19

1.0 Get to know your aircraft

- Electronic components are modular design, easy to connect and assemble.
- A new generation of flight control system is adopted to provide stable and reliable flight performance.
- GPS and GLONASS dual GPS navigation systems are used to make the flight more precise and safe.
- 5.8G WiFi digital image transmission system, high transmission speed, low latency, strong anti-interference.
- 18 x optical zoom camera, use 4K 30 FPS ultra-visual distance high-definition image transmission system, combined with three-axis brushless gimbal stabilization technology, which can realize the 360° no dead angle shooting smoothly for a long time

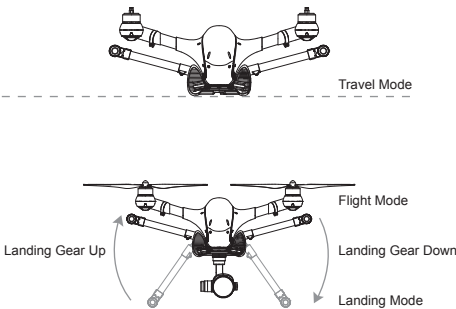
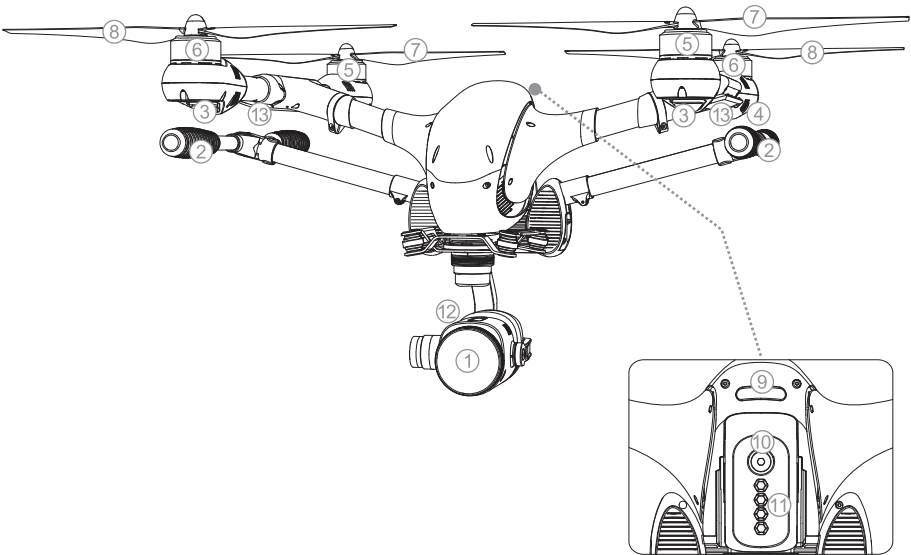

- | | |
|------------------------|-------------------------------|
| 1. Gimbal and Camera | 8. CW propeller(↻) |
| 2. Landing Gear | 9. Aircraft Status Indicators |
| 3. Front LEDs (Blue) | 10. Power Button |
| 4. Rear LEDs (Red) | 11. Battery Level Indicators |
| 5. CW motor | 12. Camera Micro SD card slot |
| 6. CCW motor | 13. Communication antenna |
| 7. CW propeller(↻) | |

* 1) To avoid property loss and personal injury caused by wrong operation, please read the manual carefully, upgrade the firmware and calibrate the related items by watching the tutorial video at www.walkera.com before using VOYAGER 4.

2) The Maximum flight time of 20 minutes was obtained under test environment.

2.0 Get to know your Remote Controller

DEVO-F8W remote controller built-in 5.8 G WIFI high resolution integration module, with complete function keys, the operation and setting of the aircraft and camera can be completed within the maximum 1.5km communication distance. It can also display HD real time images via the APP in mobile device.

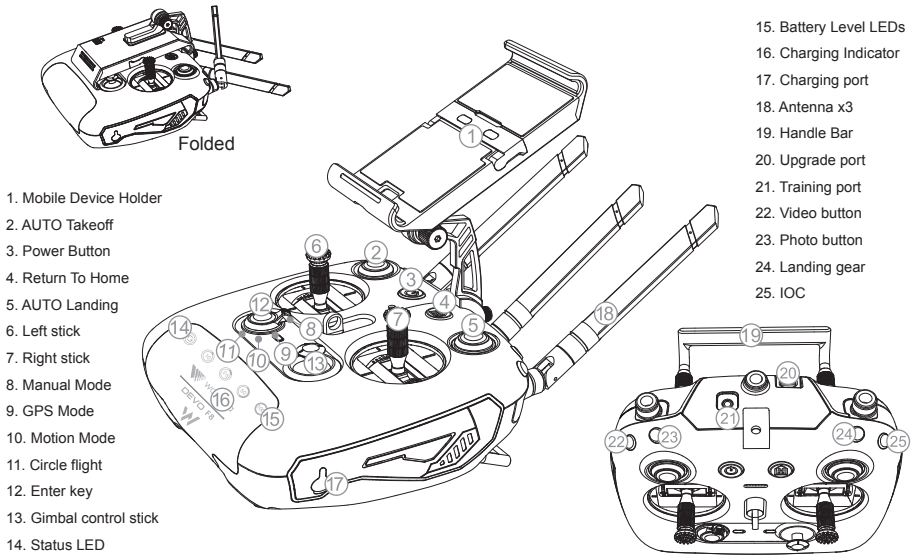

Take "left-hand throttle (MODE 2)" as an example. The left stick controls the aircraft's altitude and heading, while the right stick controls its forward, backward, left and right movements.

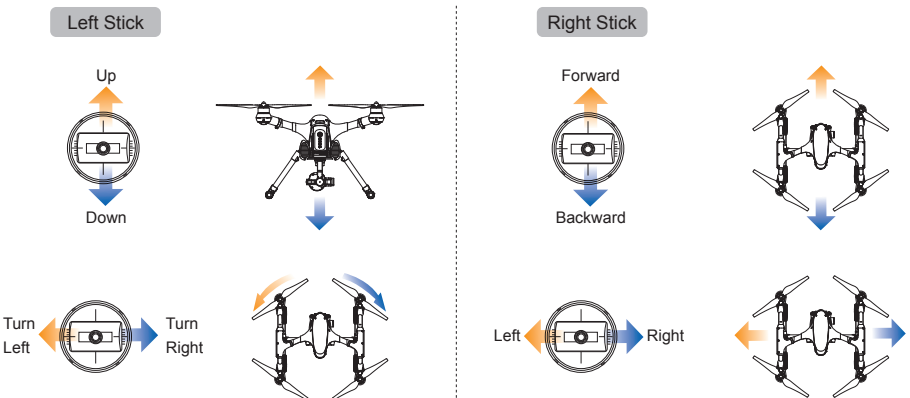

* 1) MODE 2 (Throttle stick on the left): Left stick--THRO/RUDD; Right stick --ELEV/AILE.

2) MODE 1 (Throttle stick on the right): Left stick--ELEV/RUDD; Right stick--THRO/AILE.

3) Please fly your aircraft in the open air without shelter and without electromagnetic interference.

The maximum signal range for the remote controller being about 1.5km is tested in experiment and only for reference.

3.0 Specifications

• Aircraft

Main Rotor Dia.	382mm
Overall (L x W x H)	465 x 465 x 352mm
Weight:	3250g(Battery included)
Remote Controller	DEVO F8W
Main Controller	FCS-V4
Receiver	DEVO-RX718
Brushless Motor	WK-WS-42-002A
Brushless ESC	Voyager 4 (R/B)
Battery	22.2V 4500mAh 10C(6S) LiPo
Flight Time	About 20mins
Working Temperature	-10℃ ~ +40℃

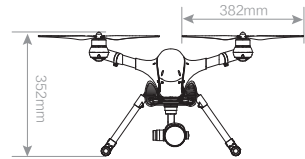
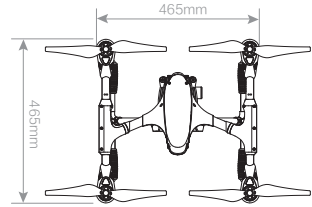

• Gimbal

Control accuracy	Static: $\pm 0.008^\circ$; Motion: $\pm 0.08^\circ$; Shake-proof: $\pm 0.008^\circ$
Control range	Pitch rotation $-90^\circ \sim +45^\circ$; Horizontal $\pm 150^\circ$

• Camera

Sensor	1/2.3 SONY IMX117 CMOS
ISO Range	100-3200(Video) / 100-1600(Image)
Video Resolution	4K 30fps
Photo Resolution	4608 x 3456
Focal Length	6.7-134.5mm
Zoom Ratio	18x optical zoom
Zoom Speed	About 2.0s
Horizontal View	$59.8^\circ - 3.0^\circ$ (Wide Angle-Telescopic)
Close-shot Distance	10 - 1500mm(Wide Angle-Telescopic)
Video Storage Maximum	32Kbps - 16Mbps
Compress Standard	H.264 / H.265
Files Format	JPG/MP4
Support Micro-SD	Micro SD/SDHC Card (maximum 128G, transmitting speed is C10 and above or UHS-1)

• Remote Controller

Overall (L x W x H)	165 x 174 x 62mm
Working frequency	2.4G
Signal range	About 1.5KM (open without shelter, no electromagnetic interference)
Built-in battery	7.4V 3000mAh Li-po 2S

4.0 Attention Before Flight

- 1) The video transmission of the aircraft is by WIFI. Please fly your aircraft in the open air without shelter and without electromagnetic interference. Avoid using it where there is WIFI interference.
- 2) This product is suitable for people who has flight experience of hobby model and ages 14 .
- 3) Do not fly in bad weather, such as windy, snowy, foggy etc..
- 4) Select the open, no-tall-buildings area. Extensive steel-used buildings will affect the compass, blocking the GPS signal, causing worse on the aircraft positioning or even not able to locate.
- 5) Please keep away from highly spinning parts(such as propellers and motors).
- 6) Please keep away from obstacles, people, water and so on.
- 7) Do not fly it in where there is high-voltage lines, communication base stations or radio towers, in order to avoid signal interference.
- 8) Don't fly in no-fly zone according to the local laws and regulations.
- 9) Flight performance will be effected with environment when flying above 4500m of sea levels, as the battery and gravity system will be influenced.

5.0 Check Battery Levels

Turn on the remote controller and intelligent flight Battery to check the battery level.

Be sure the battery was fully charged at the first use.

- 1) Long press the power button for 2~3 seconds to turn on the remote controller.
 - 2) Long press the power button for 3~5 seconds to turn on Intelligent Flight Battery.
- (Repeat above operation to turn off the intelligent flight battery and remote controller)

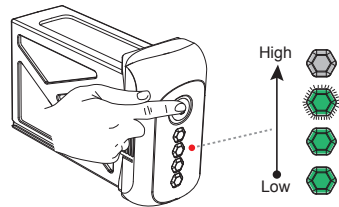
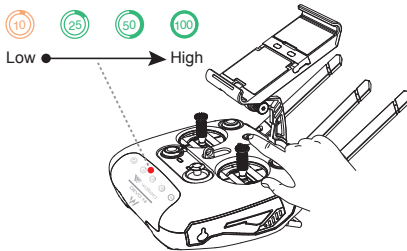

6.0 Charge the Batteries

- 1) Connect the charger to the AC power (100 ~ 240v 50/60hz).
- 2) Only use the walkera charger for your Intelligent Flight Battery and remote controller.
Please turn off the intelligent flight battery and remote controller before charging.
- 3) The Level indicator of intelligent flight battery light off means charging finished completely;
The charging indicator of remote controller turns green means remote controller charging finished completely.

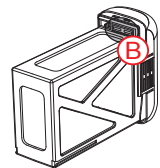
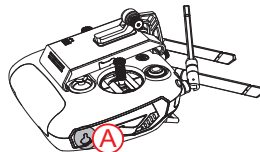
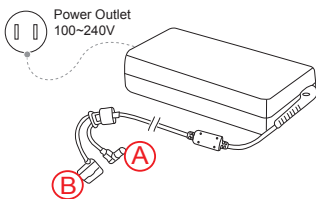

7.0 Downloading and Installing APP

APP software supports Android 5.1 and above systems iOS 9.0 and above,

Android system please download at Walkera official website (www.walkera.com) or go to Google play to search for Walker Drone or scan the QR code to download and install;

iOS system please go to the APP Store to search for Walker Aircraft or scan the QR code to download and install.



Android download



Android download



iOS download

8.0 APP Interface Instructions

On the interface, HD video and photographs can be previewed in realtime and you can set the dynamic parameters, such as aircraft, remote controller, gimbal and battery.

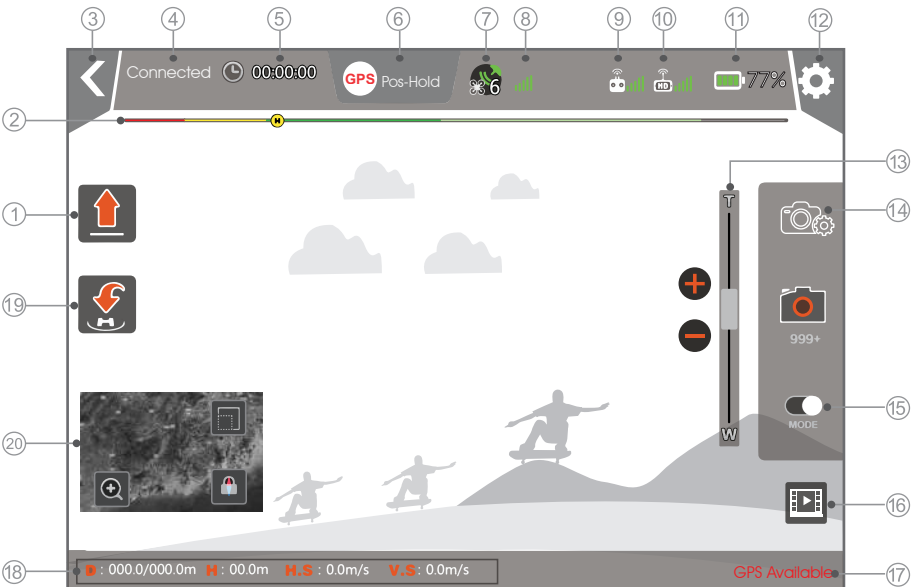

1. Auto Takeoff: Click it, the aircraft takes off automatically.
2. Battery level return: When the residual battery level reach (M), aircraft will automatically return back.
3. Back: Back to last step.
4. Device connection status: Display connected or disconnected.
5. Flight time: Aircraft flight time.
6. The aircraft model: Displays aircraft's flight mode.
7. Number of aircraft satellite: Displays the received satellites of aircraft.
8. Positioning accuracy : Displays aircraft positioning accuracy.
9. The remote controller signal strength: Displays the signal level between remote controller and aircraft.
10. Camera signal
11. Battery Levels: Real-time display the current Flight Battery remaining levels.
12. Setting: Click the icon to open the Setting menu, Normal setting, aircraft, remote controller, gimbal and battery can be charged.

VOYAGER 4 Quick Start Guide

13. The camera zoom control: divided into wide Angle (W) and telescopic (T).
14. Camera Settings :
Touch icons it has preview settings, recording settings and so on. Under identical Video Size, the larger the stream Rate, the better the picture quality, anyway, the video transmission distance is shortened accordingly.
15. Photography and video switch :
Photo: photo button is used to trigger the camera take pictures. While this function also supported in the remote controller.
Video: video button to start/stop video. It can also press the video button on the remote controller for video.
16. Video Display
17. GPS positing: GPS connected successfully displays "GPS Available", GPS didn't connect displays "GPS Unavailable".
18. Flight status parameters:
Distance(D): horizontal distance between aircraft and returning point.
Height(H): vertical distance between aircraft and returning point.
Horizontal speed(H.S): speed of aircraft in a horizontal direction.
Vertical speed(V.S): speed of aircraft in the vertical direction.
19. Return to Home: Click the button, the aircraft stop waypoint flying, and return back automatically.

20. A thumbnail map icon:
Click the thumbnail icon to quickly switch to the map interface.

Before you plan to fly, turn off the aircraft power, and connect internet, click "A thumbnail map icon" to download the map.

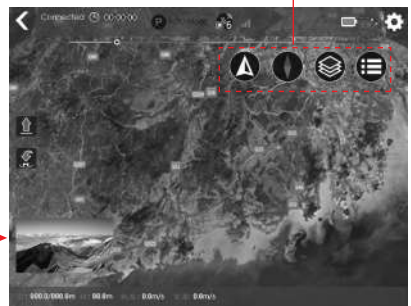
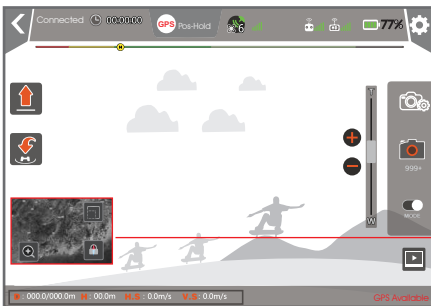
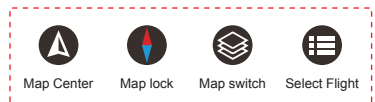

9.0 Prepare for Remote Controller

Unfold

Unfold mobile device holder and the antennas, then adjust the position of the antennas.

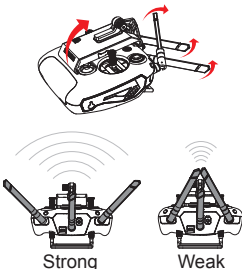

Install tablet

1. Press the button to release the clamp.
2. Place your mobile device and adjust the clamp to secure.

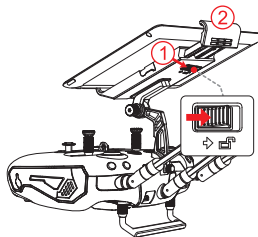

Install Cellphone

Open the cellphone block, and install the cellphone same way as tablet

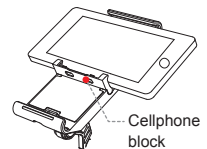

* Ensure that the aircraft is flying within the optimal transmission zone. To achieve the best transmission performance, maintain the appropriate relationship between the operator and the aircraft.

10.0 Prepare the VOYAGER 4

The factory default of the aircraft is Travel Mode. Before flying, connect to power, transform the aircraft to Landing Mode, please don't use the outside force.

1. Insert the battery.
2. Power on the remote controller and the aircraft.
3. The red LED light flashes until goes out, indicating that IMU preheating is complete and the code binding is successful. (Automatically transform the aircraft to Landing Mode.) Please turn off the remote controller and aircraft after finishing.

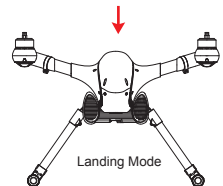
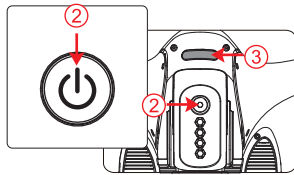
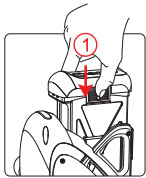
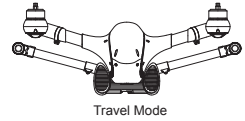

- ! Transform the aircraft to landing mode, please hold the aircraft so as not to damage the Landing Gear.
- If the red and blue lights are flashing alternately, it indicates the aircraft is not normal, see the APP indications.

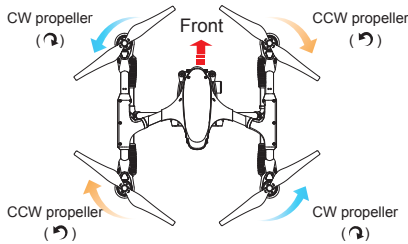

Install propellers

Fix the CW propeller (↻) onto the CW motor according to the direction of blue arrow, and fix the CCW propeller (↻) onto the CCW motor according to the direction of orange arrow. Tighten the propellers manually and make sure the propeller is installed in proper way and fastened.

Install Gimbal and Camera

1. Remove gimbal cover.
2. Aim the gimbal positioning column to upper location hole, and rotate the white line of Gimbal lock to unlocked position, align the white lines and insert the gimbal.
3. Rotate the Gimbal Lock to the locked position following to the direction of the arrow.
4. Tighten M3x3 screws to fix the Gimbal.

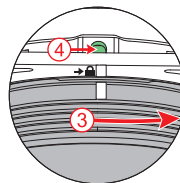
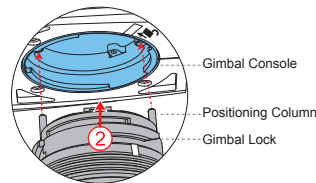
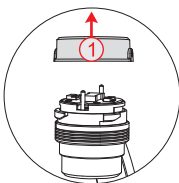
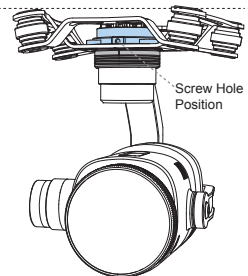

11.0 Ready for Flight

Before you plan to fly, please download the map in the APP (turn off the aircraft power, and connect internet, click the "A thumbnail map icon" to download the map.).

Place the aircraft in an open outdoor area, with its tail facing the operator.

11.1 Starting the aircraft / Get binding

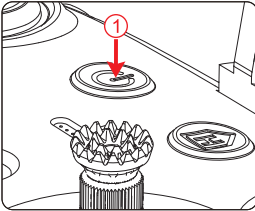

1. Power on the remote controller.

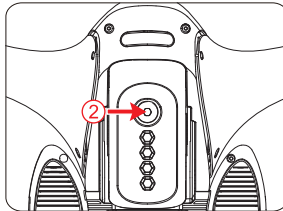

2. Power on the aircraft.

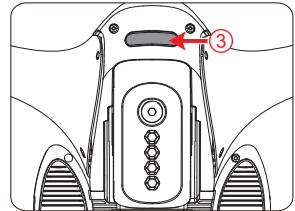

3. Place aircraft at horizontal position, the red LED light flashing until goes out indicates completion of IMU prewarming & code-matching.



4. Open the Mobile Wi-Fi device, Click "WK-Ground-***" to connect and exit settings after a successful connection.



- If the aircraft's red and blue LED lights are flashing rapidly to indicate the aircraft abnormality, please see the APP tips.

- Rotating propellers can be dangerous.

Do not start the motors when there are people nearby.

11.2 Connect the App



The APP icon

Click the icon on cellphone.

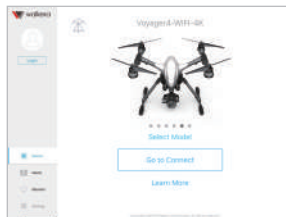

Click "Select Model", select "Voyager4-WIFI-4K", and then click "Go to Connect".

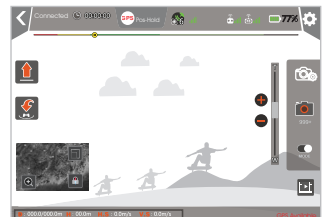

Enter main interface.

11.3 GPS Indicator Lights

When the blue LED light (GPS) begin to flash, you can work GPS function.

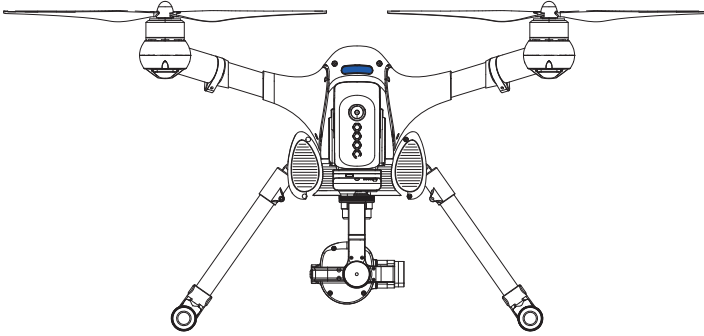

11.4 Motor Unlock / Lock

Motor Unlock

After successful code-matching, move the left & right sticks down and toggle them outward, and hold for more than 2 seconds.

You will see **the red LED lights keep on**, indicating that motors are unlocked.

The unlocked motors will rotate, and please immediately release sticks.

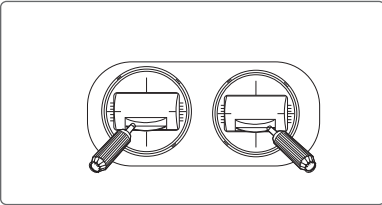

Motor Lock

There are two methods to lock the motors:

Method 1: When the aircraft is landed, move the throttle stick down and hold for 5 seconds. The motors will then stop.

Method 2: Move the left and right stick down and toggle them outward and hold for more than 2 seconds.

You will see **the red LED lights turn off**, indicating that motors are locked.

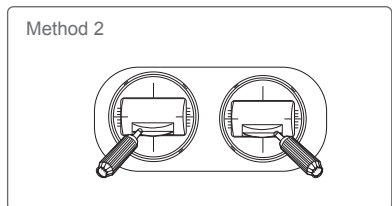
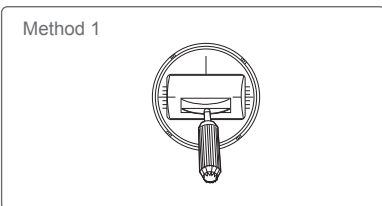

12.0 Flight Control

- 1) Make sure that the GPS signal is received (the blue LED light blinks).
- 2) Only when “Connected” displays on the upper bar of the main interface of the APP, you can perform APP operation.
- 3) Please unlock motors before takeoff. (refer to Page 11 for the detailed method)

AUTO Takeoff (Remote Controller or APP Operation)

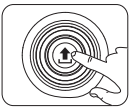

Short press this key on the controller and the aircraft will take off automatically



Please click the icon in the APP main interface, then the aircraft will take off automatically.

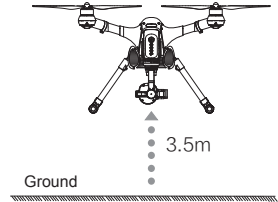

Attention:

- 1) Auto Takeoff is usable only under GPS mode or SPORTS mode.
- 2) Auto takeoff default to 3.5m altitude, and it can be removed by pushing the throttle to midpoint or above, whenever manual control over the throttle is needed.

AUTO Landing (Remote Controller or APP Operation)

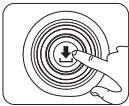

Short press this key on the remote controller and the aircraft will AUTO Landing automatically



Please click the icon in the APP main interface, then the aircraft will land automatically.

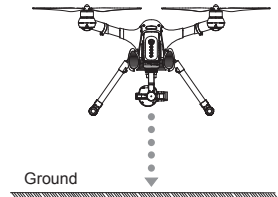

Attention:

- 1) When you used the function of “AUTO landing”, the landing gear of aircraft will be extended.
- 1) During landing, you can operate the aircraft forward, backward, rightward and leftward.
- 2) During the landing process, please switch the flight mode of the remote controller if landing needs to be cancelled.

GPS mode (Remote Controller Operation)

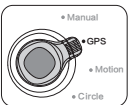

Switch to “GPS” position

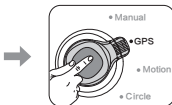

Short press the Enter key to enter the GPS hold mode

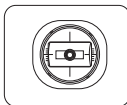

Throttle stick return neutral



Attention:

- 1) The first flight default to GPS Mode after each power on.
- 2) In the GPS mode, there are Altitude hold, fixed point, brake function, the flight speed is slower ($\leq 5\text{m/s}$).
- 3) If the GPS signal is poor or no signal, can only be Altitude hold, but not fixed point.
- 4) Switch to manual mode can not be fixed point.

Motion mode (Remote Controller Operation)

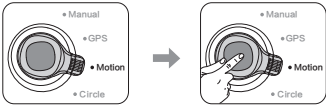

Switch to "Motion" position

Short press the Enter key to enter the Motion mode

Attention:

- 1) In the Motion mode, there are Altitude hold, fixed point, brake function, the flight speed is faster ($\leq 8m/s$).
- 2) If the GPS signal is poor or no signal, can only be Altitude hold, but not fixed point.
- 3) Switch to manual mode can not be fixed point.

Circle flight (Remote Controller or APP Operation)

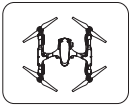

Aircraft in GPS hold mode

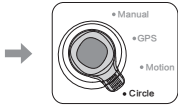

Switch to "Circle" position



Short press the Enter key to enter the circle flight mode



Please click the icon in the APP interface, then the aircraft enter circle flight mode.

Attention:

- 1) The aircraft is at a quiescent state when it is in Circle Flight. The circling function can only work after you set circle speed and direction by **toggle aileron stick left or right** (-5m/s to +5m/s speed changeable, 0m/s at default).
- 2) **Dial elevator stick up or down** to change circle radius (5-50m radius changeable, 5m at default)

Dial to the left, Clockwise circles

Dial to the right, Counterclockwise circles.

Dial up, Circle radius turns small

Dial down, Circle radius turns large

Speed: the larger volatility toggling and longer holding time, the faster circling. The slower on the contrary.

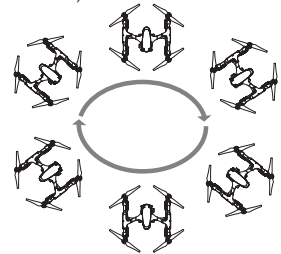

Hyper IOC Mode (Remote Controller Operation)

IOC or Intelligent Orientation Control mode means that the aircraft's flight direction is only relative to the original take-off point (where you armed the motors). REGARDLESS of the actual aircraft heading, in this mode you can fly past something and pan the aircraft to frame your shot, without having to worry what direction the aircraft is facing.

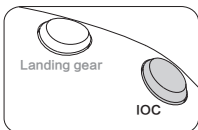

Short press "IOC" key to enter the Hyper IOC Mode

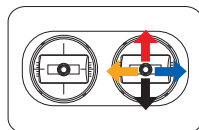

Mode2 (Throttle stick on the left)

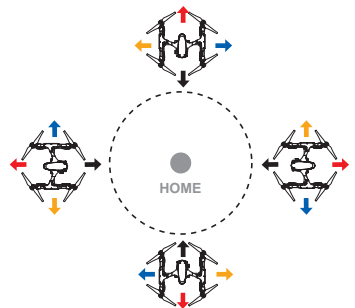

Attention:

- 1) During GPS flight, all can enter the IOC mode.
- 2) When under hyper IOC mode, you can make the drone return to the initial position only by holding the stick backwards.

RETURN TO HOME (Remote Controller or APP Operation)



Long press this key(3-5 seconds) on the remote controller and the aircraft will return automatically



Click this key in the APP interface and the aircraft will return automatically

Horizontal distance between aircraft & Home point >30m

- When the flight altitude is over RTH Height, the aircraft will keep the current altitude and automatically fly back above the Home Point, then descend vertically.
- When the flight altitude is below RTH Height, the aircraft will ascend vertically to 25m high, then automatically fly back above the HP, and descend vertically.

Horizontal distance between aircraft & Home point <30m

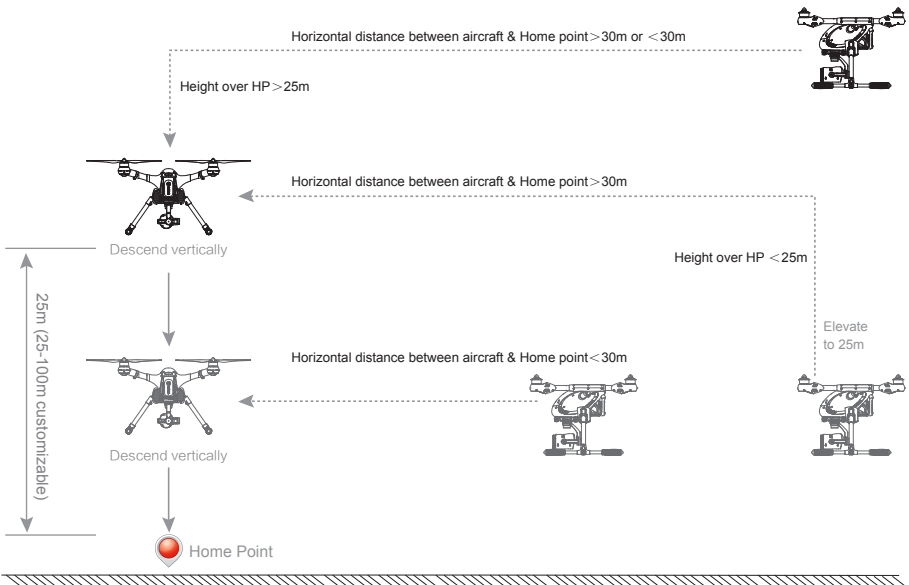

- When the flight altitude is over RTH Height, the aircraft will keep the current altitude and automatically fly back above the Home Point, then descend vertically.
- When the flight altitude is below RTH Height, the aircraft will keep the current altitude and automatically fly back above the Home Point, then descend vertically.





Attention:



- 1) After pressing Return To Home, please don't move other switches or buttons.
- 2) When the aircraft loses the remote controller's signals, it will automatically enter Failsafe RTH.
- 3) When the aircraft's battery voltage is too low and the horizontal distance between the aircraft and the Home Point is greater than 15m, the aircraft will automatically return to home. When the horizontal distance between the aircraft and the Home Point is less than 15m and the aircraft's battery voltage is too low, the aircraft will return automatically from the current position and land.
- 4) When GPS signal is abnormal or GPS not working, Auto return is unusable, but auto landing usable.
- 5) During the returning home process, please switch the flight mode of the remote controller if returning home needs to be cancelled.

Waypoint Flight (APP Operation)



Click icon  on APP map interface,
Click icon  to enter the waypoint flight interface.





-  Add → 1. Click this icon to add waypoint
-  Start → 2. Click this icon to start waypoint flight
-  Exit → 3. Click this icon to exit



Mapping (APP Operation)

Click icon  on APP map interface,
Click icon  to enter the mapping interface.

Waypoints Flight (APP Operation)

Click icon  on APP map interface,
Click icon  to enter the waypoints flight interface.

-  Add → 1. Click this icon to add waypoints
-  Clear → 2. Click this icon to clear waypoints
-  Start → 3. Click this icon to start waypoints flight
-  Exit → 4. Click this icon to exit

-  → 1. Click this icon to set fore-and-aft Course overlap, Sidelap, Waypoint Height
-  Start → 2. Click this icon aircraft will fly according to waypoints and take photos automatically.
-  Exit → 3. Click this icon to exit

Video and photo (remote controller or APP operation)

Remote Controller Operation

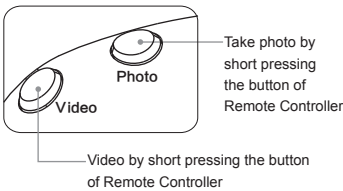

Attention:

- The video defaults to be stored in Micro SD card.
You can also change it to be stored in your mobile phone.
(Method: App main interface → Setting → Gimbal → Location)
- Please do not pull out Micro SD card during the photo or video, otherwise the data files may be lost.

APP Operation

- Choose working mode: photo or video
- Touch the Photo or video icon to take photo or video

Two ways to adjust the zoom camera: telescope(T end) and wide angle(W end).

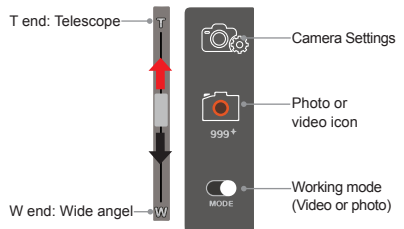

Landing gear Extended and Retracted (remote controller operation)

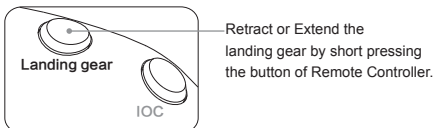

Attention:

- Make sure the landing gear retracted after the aircraft takes off.
- When the aircraft lands manually, extend the landing gear.
- In the "RETURN TO HOME" Mode, the landing gear will extend automatically till the flight end.

Control the gimbal (remote controller or APP operation)

Three-axis stabilization gimbal makes the camera steady so that it can shoot stable photos even fly with high altitude. And you can control pitch and horizontal angle of the gimbal by Gimbal stick on Remote Controller or APP Software.

Gimbal have two modes: Follow me mode and Lock mode, please choose the mode you need.

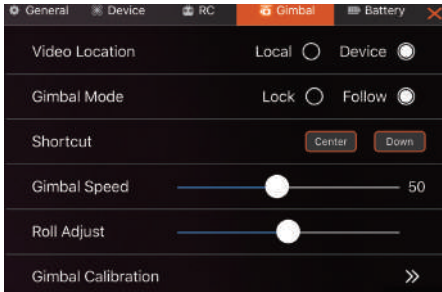

Follow me mode
Gimbal pointing move with aircraft nose direction



Lock mode
Gimbal pointing stay unchanged when aircraft nose move

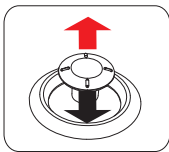

Gimbal Stick up or down.



In APP image interface swipe up or down.

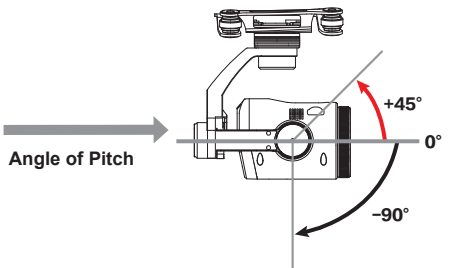

Angle of Pitch

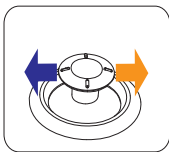

Gimbal Stick Left or Right.



In APP image interface swipe left or right.

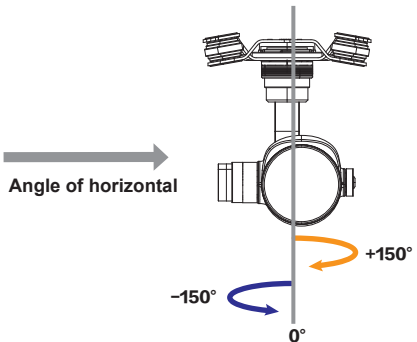

Angle of horizontal

Attention:

- 1) You must select the mode first and then adjust the angle. In follow me mode, the horizontal angle (YAW) is not adjustable.
- 2) Gimbal stick position determines the rate of change of the gimbal: when the stick located at the midpoint the velocity is zero, the greater the offset of the stick gimbal changes faster, whereas the slower.

13.0 End flight

1. Manual landing or return to home function landing.
2. First, Power off the aircraft, then turn off the Remote Controller.
3. Finally, remove the battery from the aircraft.

14.0 Additional remarks

14.1 Compass Calibration

- ⚠ If there is circles or drift in flying, please calibrate the compass.
(the motor must be locked and the red LED light turn off)
- Please calibration outdoors and far away from strong electromagnetic interference.

The compass calibration steps are as follows:

1. Place right/left sticks at lowest location, toggle them inward and keep for 5 seconds until the aircraft's red LED light flash quickly .
2. Horizontal 360° rotation of aircraft until red LED light turn off and blue LED light flash quickly.
3. Vertical 360° rotation of aircraft (heading down) until blue LED light turn off, indicating successful calibration, and place aircraft at a horizontal location
In case of failure to calibrate, please follow above procedure to repeat calibration.

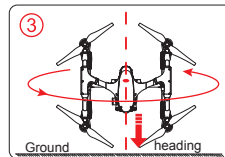
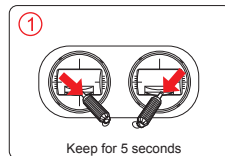

14.2 Introduction for FCS-V4 Main Flight Controller

Flexible flat cable connection

The metal surface of flexible flat cable plug should be inserted upward to main controller port properly.

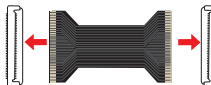

The metal surface of flexible flat cable plug should be inserted downward to power board port properly.

Port introduction

1. GPS Port: connect GPS module
2. Micro SD card slot: Place the Micro SD card position
3. UART Port: not used
4. USB port: used for upgrading
5. Connection port: used to connect flexible flat cable

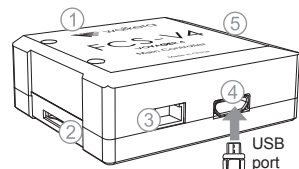

Upgrading

Please upgrade online via Walkera official website





14.3 Stick Mode Switch, Stick Calibration and Customize Fixed ID



- Factory setting of DEVO F8W stick mode & stick calibration has been determined; please refer to the following operation method for switching and calibration.
- Be sure to switch off the aircraft power or lock motor before operation.

Stick Mode Switch

Enter stick Mode switch	1. Long press "  " 3~5 sec ➔ When power indicate lights off, enter the stick mode switch.
	2. Short press "  " ➔ Choose MODE 1、MODE 2
Exit stick Mode switch	3. Long press "  " 3~5 sec ➔ When power indicate lights up, exit the stick mode switch.

MODE 1 is right-hand throttle

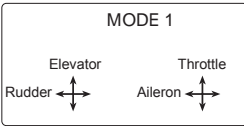

MODE 2 is left-hand throttle

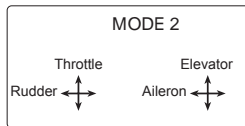

power indicate lights match the stick mode

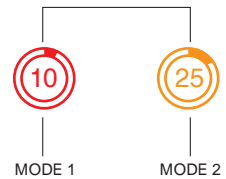

※ **Customization also supported in APP.**

Stick calibration

Long press "  " button for 3 to 5 seconds, four lights flash alternately to enter stick calibration.





Operate the stick several times within mechanical tuning range and then back in the middle.

Long press the "  " button for 3 to 5 seconds again, four indicator lights turn on, then exit stick calibration.



- When you exit if vibrate alert, then the calibration fails, please recalibrate.

DEVO F8W Remote Controller customize Fixed ID

Long-press "  " button for 3-5 seconds, when the "drop" sound to set the fixed ID. (for the first time to set fixed ID code, Battery Level indicator     flashes from left to right and then all the light solid.)

Long-press "  " button 3-5 seconds again, when the "drop drop" sound to clear the fixed ID.

15.0 Intelligent Flight Battery Safety Guidelines



- Store Intelligent Flight Batteries in a ventilated location.
- To avoid fire, serious injury, and property damage, observe the following safety guidelines when using, charging, or storing your batteries.

15.1 Battery Use

- 1) DO NOT allow the batteries to come into any kind of liquid. DO NOT leave batteries out in the rain or near a source of moisture. DO NOT drop the battery into water. If the inside of the battery comes into water, chemical decomposition may occur, potentially resulting in the battery catching on fire, and may even lead to an explosion.
- 2) Never use non-walkera batteries. Go to www.walkera.com to purchase new batteries. Walkera takes no responsibility for any damage caused by non-walkera batteries.
- 3) Never use or charge swollen, leaky, or damaged batteries. If your batteries are abnormal, contact Walkera or a walkera authorized dealer for further assistance.
- 4) Never install or remove the battery from the aircraft when it is turned on. DO NOT insert or remove batteries if the plastic cover has been torn or compromised in any way.
- 5) The battery should be used in temperatures from -10 °C to 40 °C. Use of the battery in environments above 50 °C can lead to a fire or explosion. Use of battery below -10 °C the life cycle of battery will be damaged.
- 6) DO NOT use the battery in strong electrostatic or electromagnetic environments. Otherwise, the battery control board may malfunction and cause a serious accident during flight.
- 7) Never disassemble or pierce the battery in any way or the battery may leak, catch fire, or explode.
- 8) Electrolytes in the battery is highly corrosive. If any electrolytes contacts with your skin or eyes, wash the affected area with fresh running water at least 15 minutes, and then see a doctor immediately.
- 9) DO NOT use the battery if it was involved in a crash or heavy impact.
- 10) If the battery falls into water with the aircraft during flight, take it out immediately and put it in a safe and open area. Maintain a safe distance from the battery until it is completely dry. Never use the battery again and dispose it properly.
- 11) DO NOT put batteries in a microwave oven or in a pressurized container.
- 12) DO NOT place loose battery cells on any conductive surface, such as a metal table.
- 13) DO NOT put the loose cells in a pocket, bag or drawer where they may short-circuit against other items or where the battery terminals could be pressed against each other.
- 14) DO NOT drop or strike batteries. DO NOT place heavy objects on the batteries or charger. Avoid dropping batteries.
- 15) Clean battery terminals with a clean, dry cloth.

15.2 Battery Maintenance

- 1) Never over-discharge, as this may lead to battery cell damage.
- 2) Never use the battery when the temperature is too high or too low.
- 3) Battery life may be reduced if not used for a long time.



Manufacturer: Guangzhou Walkera Technology Co.,Ltd.

Add: No.48 Wantai Rd, Taishi Industrial Park, Dongchong Town,

Nansha Dist, Guangzhou, China.511453

Hotline:+86 20-84915115

