

TYPHOON

Plus

USER MANUAL V1.0

with Intel® RealSense™ technology



Intel and Intel RealSense are trademarks of Intel Corporation or its subsidiaries in the U.S. and /or other countries.



YUNEEC

CONTENTS

| | |
|---|----|
| Product Profile | 03 |
| Introduction | 03 |
| Specifications | 03 |
| Overview | 07 |
| Aircraft | 07 |
| Charging | 07 |
| Installing the Battery | 08 |
| Unfolding the Arms | 08 |
| Compass Calibration | 09 |
| Installing the Propellers | 09 |
| Placement Before Takeoff | 10 |
| Powering ON/OFF | 10 |
| Binding | 11 |
| Binding the Aircraft and ST16S | 11 |
| Binding the Aircraft and C23 | 11 |
| Takeoff | 11 |
| Option 1 | 11 |
| Option 2 | 12 |
| Flight Modes | 12 |
| Angle Mode | 12 |
| Obstacle Avoidance Switch | 12 |
| Sport Mode | 13 |
| IPS Mode | 13 |
| RTL Mode | 13 |
| -REALSENSE TURNED OFF | 14 |
| -REALSENSE TURNED ON | 14 |
| Task Mode | 15 |
| - CCC | 15 |
| - Follow Me | 16 |
| - Watch Me | 16 |
| - Journey | 16 |
| - POI | 17 |
| - Orbit | 17 |
| Landing | 17 |
| Remote Controller | 18 |
| ST16S Charging | 18 |
| Flight Control | 18 |
| Proportional Control Rate Slider | 19 |
| Camera Control | 19 |
| Gimbal Camera Tilt Control | 19 |
| Gimbal Camera Pan Control | 19 |
| Appendix | 19 |
| Upgrading the Firmware | 19 |
| LED Status Indication | 21 |
| Disclaimer | 22 |
| Collection and Processing of Data | 23 |
| Battery Warnings and Usage Guidelines | 23 |
| General Safety Precautions and Warnings | 24 |
| Camera Usage Warnings | 25 |
| Indoor Position System Precautions | 25 |
| FCC Statement | 26 |
| RF Exposure Warning | 26 |
| IC Radiation Exposure Statement for Canada | 26 |
| NCC Warning Statement | 27 |
| CE Warning Statement | 27 |
| EU Compliance Statement | 27 |

Product Profile

Introduction

The TYPHOON H PLUS provides high-end image quality combined with the reliability and automated flight modes every photo and videographer desires. The TYPHOON H Plus hexacopter is equipped with a 1" camera with 4K video resolution, a PX4-based flight controller, flight modes from Follow Me and Point of Interest to Curve Cable Cam. Relevant core areas of the TYPHOON H PLUS have been completely redesigned to provide more reliability and power for your everyday needs. To meet different needs for function and portability, TYPHOON H PLUS has two configurations: the professional version with Intel® RealSense™, equipped with a portable backpack, and the advanced version with Sonar Collision Avoidance. TYPHOON H plus with Intel® RealSense™ technology builds a 3D model of the world. The Intel® RealSense™ module provides high quality depth to the host system and enables the drone to make intelligent choices about creating routes around obstacles.

Specifications

| Aircraft | |
|-------------------------------------|--|
| Product Name | APV System |
| Model | TYPHOON H PLUS |
| Max Takeoff Weight | 72.31oz (2050g) |
| Dimensions | 21.9x19.1x12.0in (556x485x305mm) |
| Diagonal Size (Propellers Excluded) | 20.4in (520mm) (Six Rotors) |
| Propeller Size | 9.8in (248mm) |
| Propeller Pitch | 5.7in (145mm) |
| Max Ascent Speed | 8.9mph (4m/s) |
| Max Descent Speed | 5.6mph (2.5m/s) |
| Max Speed | Sport: 44.7mph (72Km/h), Angle: 31.1mph (50Km/s) |
| Max Tilt Angle | Sport mode: 35°, Angle: 35° |
| Max Angular Speed | 150°/s |
| Max Service Ceiling Above Sea Level | 16404ft (5000m) (Tested) |
| Max Flight Time | Approx. 25min |
| Operating Temperature Range | 32° to 104°F (0° to 40°C) |
| Satellite Positioning Systems | GPS/GLONASS |
| Operating Environment | Regular Flight Condition, No Transparent Obstacles |
| Obstacle Sensory Range | 1.6ft-30ft (0.5m-10m) (RealSense) |
| Front Obstacle Avoidance Sensor | Ultrasonic Sensor and RealSense |

| | |
|---|---|
| Motor Type | Permanent Magnet Brushless DC motor |
| | |
| | |
| Flight Battery | |
| Type | LIPO 4S |
| Capacity | 5250mAh |
| Voltage | 15.2V |
| Energy | 79.8Wh |
| Net Weight | 20.5oz (580g) |
| Charger | SC4000-4H |
| Charging Time | Approx. 1.5h-2h |
| Max Charging Current | 5A |
| | |
| | |
| ST16S Ground Station | |
| Product Name | Personal Ground Station |
| Model | ST16S |
| Operating System | Android™ |
| Number of Channels | 16 |
| Control Transmission Distance/Range | Up to 1 mile (1.6Km) (Optimum condition) |
| Video Link Frequency Band | 5.8GHz WiFi |
| Video Transmission Distance/ Range(Optimum Conditions) | FCC Compliance: up to 1.2mile (2Km) CE Compliance: up to 1.2mile (2Km) |
| LCD Screen Size | 7in |
| Built-in Battery Voltage/Capacity | 3.6V 8700mAh 31.32Wh Li-ion |
| Max Charge Current | 1A |
| | |
| | |
| | |
| | |
| | |
| | |
| | |

| | |
|---|--|
| RealSense | |
| Weight | 2.5oz (70g) |
| Dimensions | 6.0*4.2in (153*107mm) |
| Maximum detecting distance from forward facing obstacle | 23ft (7m) |
| Distance front collision avoidance | 9.8ft to 23ft (varying according to the environment) |
| Ground to IPS distance | 13.1ft (4m) |
| Maximum speed under module collision avoidance | 8.9mph (4m/s) |
| Field of view(vertical) | 40° |
| Field of view(Horizontal) | 60° |
| | |
| | |
| | |
| C23 Gimbal Camera | |
| Product Name | 3-Axis Gimbal Camera |
| Model | C23 |
| General | |
| Dimensions | 4.5x3.1x5.1in (115x80x130mm) |
| Weight | 12.3oz (275g) |
| Operating Temperature | 32° to 104°F (0° to 40°C) |
| Storage Temperature | 14° to 122°F (-10° to 50°C) |
| SD Card Max/Min Capacity | 128GB |
| Gimbal | |
| Stabilization | 3-axis (pitch, roll, yaw) |
| Angular Vibration Range | ±0.02° |
| Mount | Detachable |
| Max Angular Velocity | Pitch: 30°/s, Yaw: 120°/s |
| Camera | |
| Controllable Range | Pitch: -90° to +15° |
| Sensor | 1 in CMOS, Effective Pixels: 20MP |
| Lens | FOV 91° F/2.8, 23mm Format Equivalent |
| Photo Resolutions | 3:2, 5472x3648 4:3, 4864x3648 16:9, 5472x3080 |

| | |
|--------------------------|---|
| Video Resolutions | <p>H.264 4096×2160 (24/25/30/48/50/60fps) 3840×2160 (24/25/30/48/50/60fps) 2720×1530 (24/25/30/48/50/60fps) 1920×1080 (24/25/30/48/50/60/120fps) 1280×720 (24/25/30/48/50/60/120fps)</p> <p>H.265 4096×2160 (24/25/30fps) 3840×2160 (24/25/30fps) 2720×1530 (24/25/30/48/50/60fps) 1920×1080 (24/25/30/48/50/60/120fps) 1280×720 (24/25/30/48/50/60/120fps)</p> |
| Photo Formats | JPEG, JPEG + DNG |
| Video Formats | MP4 |
| Photography Modes | Single, Burst (3/5/7), Interval (5s, 7s, 10s, 15s, 20s), Panorama |
| Exposure Mode | Auto Exposure, Manual Exposure |
| Exposure Compensation | ±3.0 |
| ISO Range | 100 – 6400 |
| Electronic Shutter Speed | 4 – 1/8000s |
| White Balance | Lock, Daylight, Cloudy, Automatic, Fluorescent, Incandescent, Sunrise |
| Metering Mode | Spot Metering, Center Metering, Average Metering |

Overview

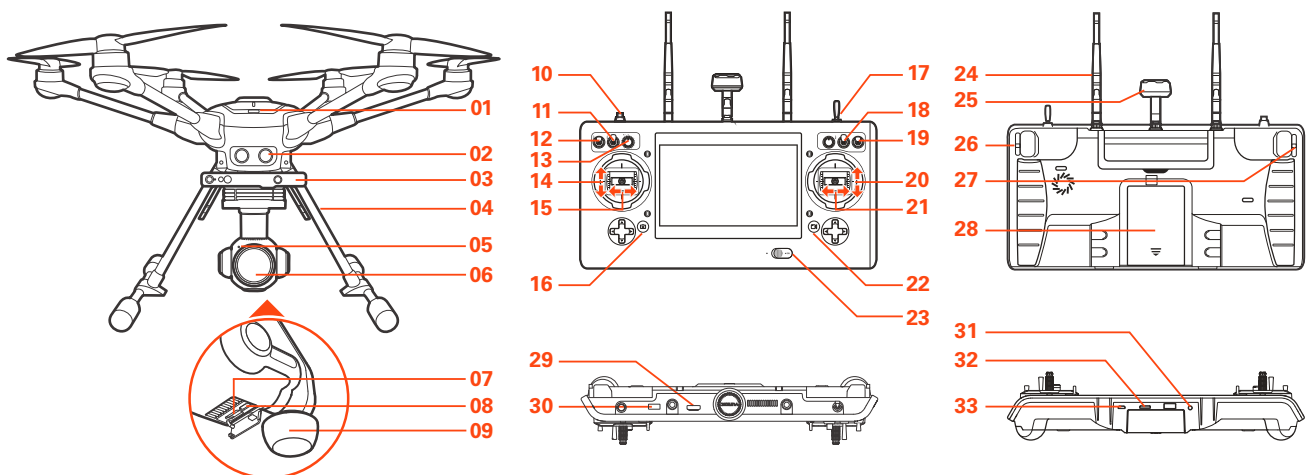

TYPHOON H PLUS

- 01** Power Switch
- 02** Sonar
- 03** RealSense™
- 04** Retractable Landing Gear

ST16S

- 10** Start/Stop Motor Button
- 11** Gimbal Pan Mode Switch
(Follow Mode/Follow Pan
Controllable Mode/Global Mode)
- 12** Gimbal Tilt Mode Switch
(Angle Mode/Velocity Mode)
- 13** Gimbal Pan Control Knob
- 14** Throttle/Altitude Control (Mode 2)
Elevator/Pitch Control (Mode 1)
- 15** Rudder/Yaw Control
(Mode 2 and Mode 1)
- 16** Take Still Photo Button
- 17** Landing Gear Switch
- 18** Obstacle Avoidance Switch
- 19** Flight Mode Selection Switch

C23

- 05** Camera LED Status Indicator
- 06** Camera Lens
- 07** Micro SD Card Slot
- 08** USB Port
- 09** 5GHz Antenna
- 20** Elevator/Pitch Control (Mode2)/
Throttle/Altitude Control (Mode 1)
- 21** Aileron/Roll Control
(Mode 2 and Mode 1)
- 22** Start/Stop Video Recording Button
- 23** Power Switch
- 24** 2.4GHz Antenna
- 25** 5GHz Antenna
- 26** Proportional Control Rate Slider
- 27** Gimbal Tilt Control Slider
- 28** Battery
- 29** HDMI
- 30** USB Port
- 31** Headset Port
- 32** Micro SD Slot
- 33** Micro USB Port

Aircraft

Charging

Power the desktop charger from a 100-240V AC outlet using the AC adapter/power supply, or from a 12V-17.4V DC accessory socket/cigarette lighter receptacle in an automobile using the included adapter. Plug the aircraft battery into the charger port as illustrated.

A green blinking LED indicates the charger is powered on and ready to charge, and a red blinking LED indicates the battery is charging. It will take approximately 2.5 hours to charge a fully discharged (not over-discharged) battery. A solid green LED indicates the battery is fully charged. Alternating blinking and solid blue LED lights indicates Error.

Be certain to never completely drain a TYPHOON H PLUS battery. Batteries should be stored at 30-50% charge, and never stored at full charge.

WARNING: All instructions and warnings must be followed exactly to prevent property damage and/or serious injury as the mishandling of Li-ion/LiPo batteries can result in a fire.

NOTICE: Yuneec offers a dual port quick charger (DY5, YUNDY3) that will charge your batteries faster, and includes a storage function to either charge or discharge your battery to the safe storage percentage. To purchase it, please visit www.yuneec.com

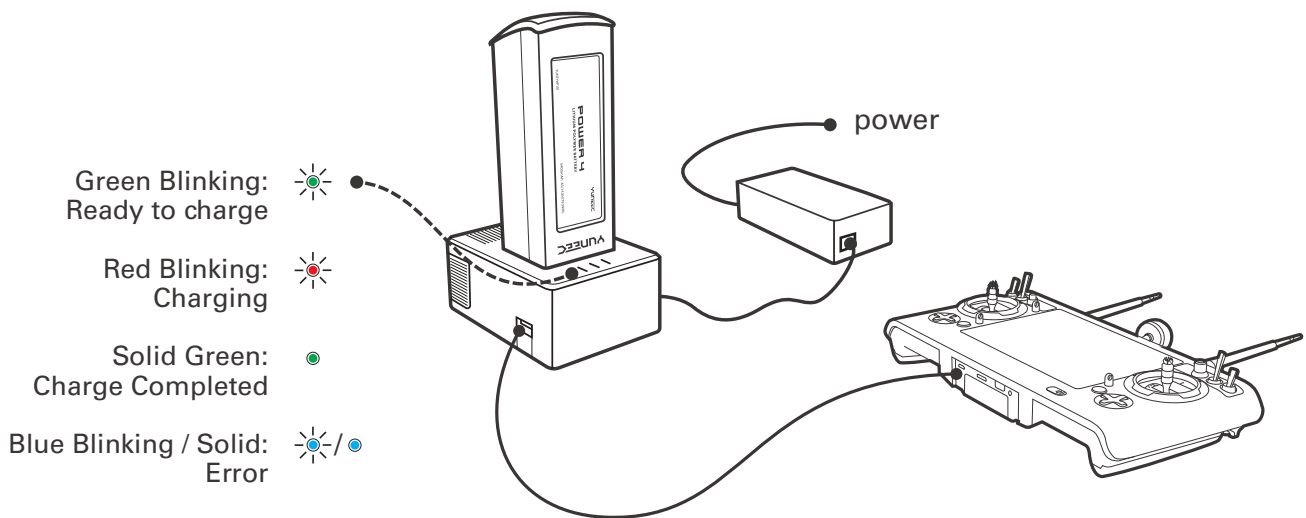

Installing the Battery

Push the battery into the battery compartment until hearing a 'click'.

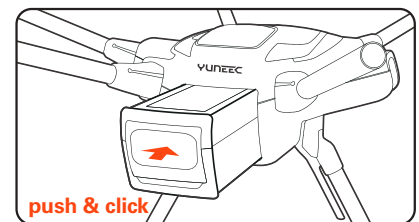

Unfolding the Arms

Once the TYPHOON H PLUS has been removed from the storage/transport case, lock the arms in place. Gently lift the arms until a click is heard.

To unlock the arms, press the PRESS button on the base of the arms. On new systems, it may be necessary to release the arms while lifting up on the bottom of the motor with one hand and pressing the Press button with the other. Doing so relieves some of the pressure on the locking system.

NOTICE: Do not depress the PRESS button on the arms while unfolding and locking them into place; doing so may cause the arms to not engage the locking system.

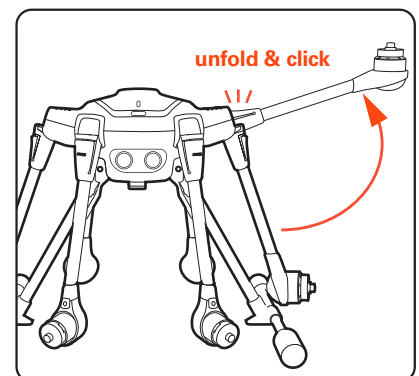

Compass Calibration

CAUTION: Do not calibrate the compass in parking garages, close to buildings or near roads with a metal core. For optimum performance, only calibrate TYPHOON H PLUS in open spaces, far away from power lines and other metal structures or concrete buildings.

NOTICE: Be sure to perform the compass calibration procedure at least 11 feet away from the nearest cell phone or other electronic devices to ensure proper calibration.

STEP 1: Power on the ST16S Ground Station first and then the aircraft, and make sure they are connected correctly. If they are not connected correctly, the telemetry data will not display on the screen.

STEP 2: Tap the System icon on the top right corner on the ST16S, and then enter the aircraft setting interface by tapping **FOF**, select the Compass Calibration.

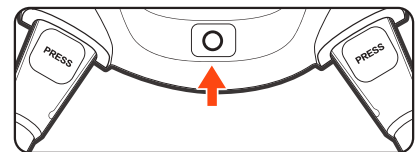
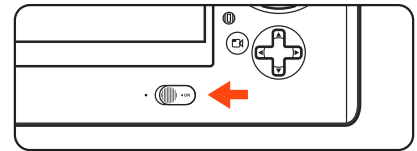
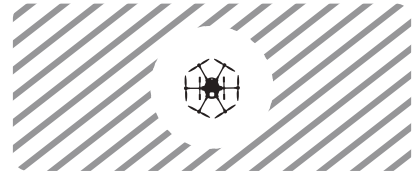

STEP 3: Lift the TYPHOON H PLUS airframe straight and level. When the LEDs on two motors start to blink green as illustrated, turn it forward as shown by the red arrow until a tone is heard and the two LEDs turn off.

STEP 4: Repeat this procedure for all six positions.

If the calibration has been successful, all LED Status Indicators will blink green, and then come back to the previous status. The users will recognize this when hearing the acknowledgement tone.

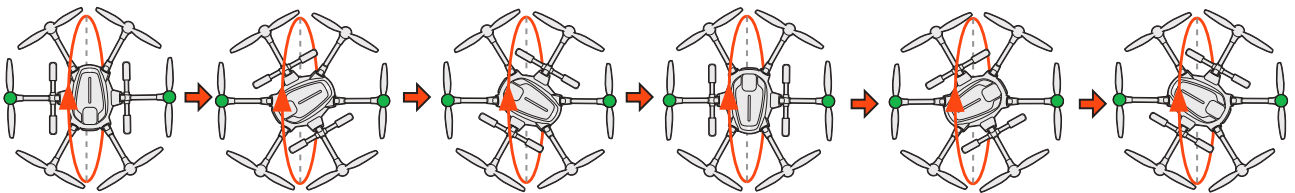

IMPORTANT NOTE: If the calibration has failed, all LED Status Indicators will blink red rapidly and the users must repeat the calibration process. If the calibration continues to fail, either the site of calibration is unsuitable or the compass is defective. Refer to YUNEEC service center.

Installing the Propellers

Each arm of the TYPHOON H PLUS has a letter A or letter B labeled on it. There is a black button at the center of the motor on each "A" arms. There is a white button at the center of the motor on each "B" arms.

Each propeller has an A or B label etched into the blade. "A" propellers cannot be attached to "B" motors, nor can "B" motors be mounted to an "A" motor.

Match the A propellers with the A arms (black center button) and the B propellers with the B arms (white center button). Place the propeller on the motor and lightly press down while holding the motor, turning the propeller in lock direction as shown. A click will be heard and the center button will slightly pop up. Hold the motor and test propeller security to assure a locked propeller.

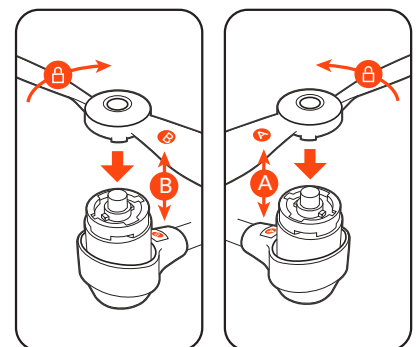

Disassembling the propellers

Press and hold the center button into the mounting plate, and then rotate the propeller in the direction the arrow points to.

IMPORTANT NOTE: Always check the props for damage and rough edges. Damaged props may cause in flight vibrations causing unwanted flight characteristics. Propellers should be replaced every 20 flight hours.

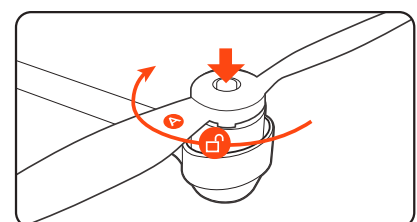

Placement before Takeoff

WARNING: When flying outdoors, always operate the TYPHOON H PLUS in open areas (approximately 10000 square feet/930 square meters or more) that are free from people, vehicles, trees and other obstructions. Never fly near or above crowds, airports or buildings.

Never attempt to operate TYPHOON H PLUS nearby tall buildings/obstructions that do not offer a clear view of the sky (a minimum clearance of 100°).

Be sure to place the TYPHOON H PLUS on a level and stable surface before powering ON the TYPHOON H PLUS Aircraft and the ST16S Ground Station.

IMPORTANT NOTE: STEP BACK APPROXIMATELY 26 FEET (8 METERS) BEHIND THE TYPHOON H PLUS.

NOTICE: Pilots are recommended to take off the aircraft in Angle Mode. If the pilot takes off the aircraft in Smart Mode, make sure to keep the air craft 32.8ft (10m) away from the pilot.

NOTICE: For indoor flight, Please refer to the Indoor Position System Precautions in the appendix to operate the aircraft.

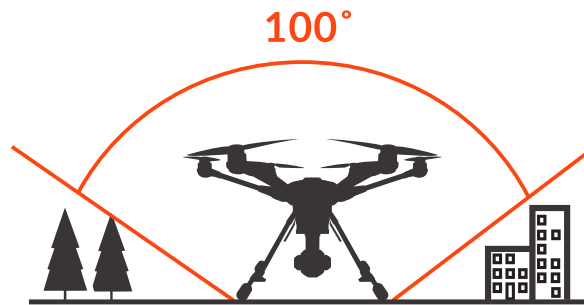

Powering ON/OFF

NOTICE: Please make sure all firmware is the latest version. Firmware can be downloaded by OTA and the user manual may be downloaded from web site: www.yuneec.com. The quick start guide does not replace the user manual.

Turn on the ST16S, and then press the power button on TYPHOON H Plus. Release the button when the aircraft emits a rising tone. Power on the ST16S before powering on the UAS.

NOTICE: If the aircraft fails to initialize, please deal with it according to the pop-up prompts of the remote controller. To power off the aircraft, press and hold the power button until the aircraft emits a falling tune.

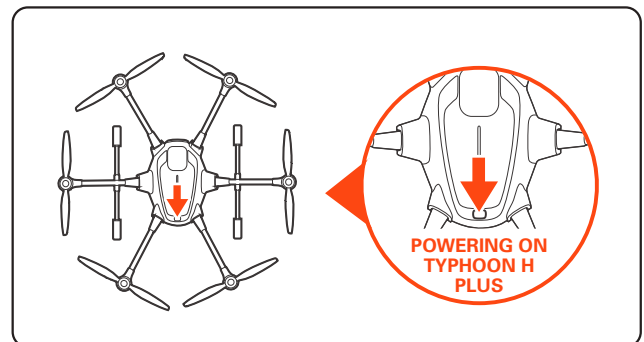
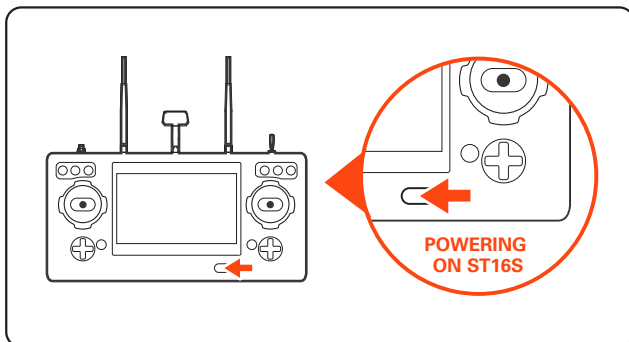

Binding



Binding the aircraft and ST16S

NOTICE: The aircraft and ST16S Ground Station are already bound out of factory. There is no need to bind them. Pilot can follow the steps below if binding is needed.

STEP 1: Power on the TYPHOON H PLUS. After initialization completes, the two LEDs on rear arms will blink blue.

STEP 2: Lift the aircraft upside down until all LEDs blink yellow quickly, and then turn the aircraft back on straight and level ground.

STEP 3: Switch on the ST16S Ground Station. Wait a few seconds for the ST16S system initialization to be completed.

STEP 4: Tap the settings icon () on the right top corner of the ST16S. Select the icon () and choose the Drone.



STEP 5: Tap the refresh icon (), and then tap OK to unbind RC link. Select the corresponding receiver listed in the column. Wait until a tip pops up to indicate the binding is completed.

Binding the aircraft and C23

Step 1.

Switch on the ST16S followed by the TYPHOON H PLUS aircraft.

Step 2.

Tap the  on the top right corner on the main interface of ST16S, then tap the  on the switching interface.

Step 3.

Tap the serial number of the C23 when the following window pops up. (If multiple Yuneec UAS are used, check the ID number on the side of each camera to assure correct camera selection/binding).

Step 4.

Using the password "1234567890", authorize the camera and tap "OK" to confirm.

NOTICE: If the connection process is delayed, close the pop up window and then repeat the above steps.

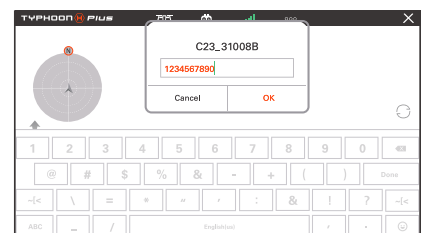
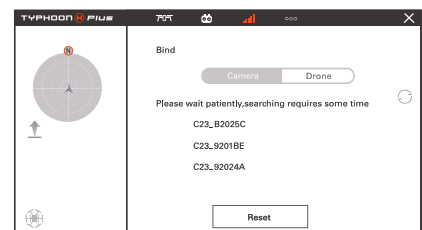
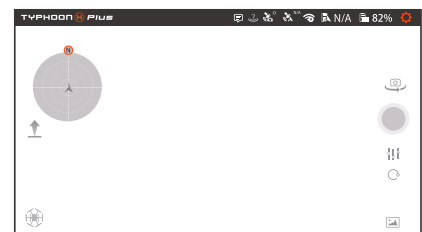

Takeoff



Option 1

Press and hold the START/STOP button until the aircraft boots up.

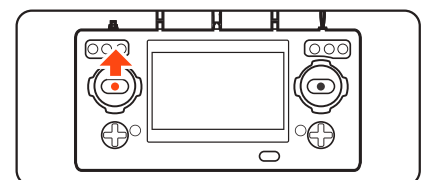
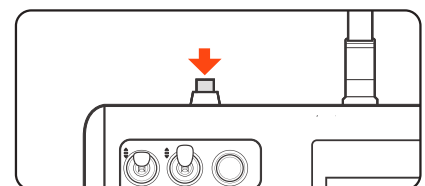
Step back approximately 26 feet (8 meters) behind TYPHOON H PLUS. When there is suitable GPS signal for both the ST16S Ground Station and TYPHOON H plus, slowly raise the left-hand stick to slightly above the center position. The aircraft will take off and climb slowly (or raise the stick further until it does). Allow the stick to return to the center position when the aircraft reaches the desired altitude.



Option 2

Press the icon (), then slide the sliding block, and the aircraft will take off. Then the icon () will turn Point-to-Land icon ().

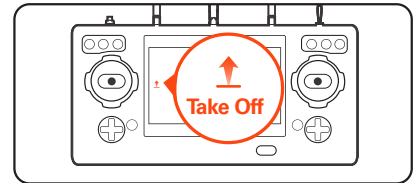

Retracting the Landing Gear

Raise the landing gear control using the landing gear control switch on the ST16S.

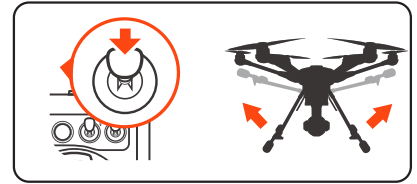

Flight Modes

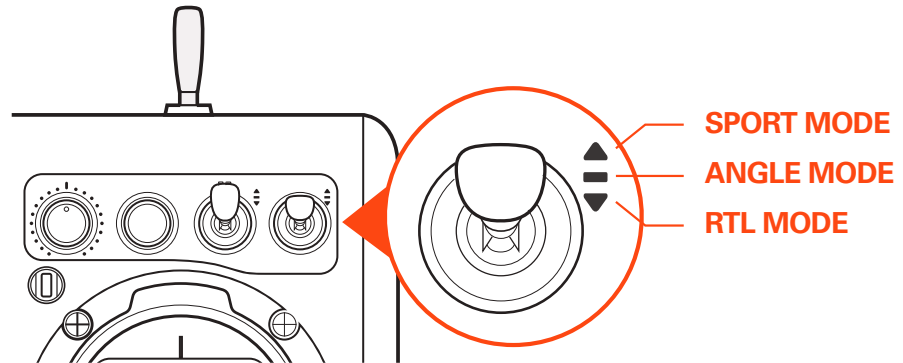

Angle Mode

If the Flight Mode selection switch is in the center position, then the aircraft is in Angle Mode. In this mode the aircraft moves in line with the joystick, in the direction in which the nose is pointed. So, if you move the right stick to the left, the TYPHOON H PLUS will tilt to the left and thus move to the left. That is assuming that the nose is pointing away from you. If the nose is pointing towards you, the aircraft will move to the right from your point of view.

NOTICE: The TYPHOON H PLUS will hold its position automatically when GPS is on (if there is sufficient GPS signal) and it will retain the altitude level if the left stick is in the middle position.

NOTICE: When turning off the RealSense, the maximum speed of the TYPHOON H PLUS should be less than 30.2MPH (13.5m/s). When turning on the RealSense, the maximum speed should be less than 8.9MPH (4m/s).

NOTICE: When in the Angle Mode, the aircraft will stop in front of the obstacle with realsense activated.

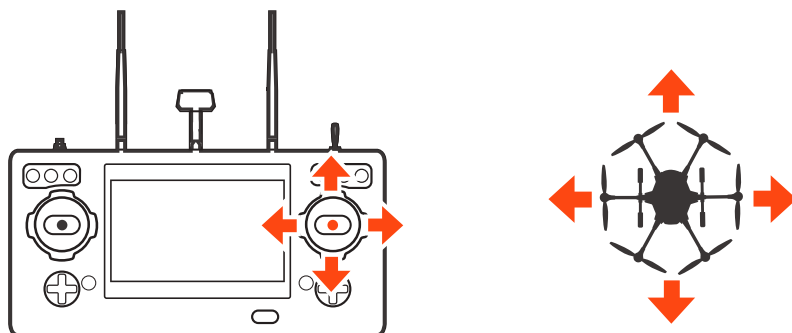

OBSTACLE AVOIDANCE Switch

With sustainable GPS locked, the RealSense can be activated in Angle Mode, RTL Mode and Follow/Watch Me Mode. When the RealSense is activated, the front motor LEDs will blink white and the ST16S screen will display a []. When the OBSTACLE AVOID is switched on, the screen will pop up 'OBS activated' .

IMPORTANT NOTE: When the flight height is lower than 1.5m, the OBSTACLE AVOIDANCE will be disabled.

NOTICE: The RealSense can only detect the front obstacles, but can't detect the lateral and rear obstacles.

NOTICE: The speed of the aircraft will be limited with RealSense activated.

NOTICE: For the most up-to-date information of OBSTACLE AVOID, please visit the corresponding product page at www.Yuneec.com or contact the nearest Yuneec office or authorized distributor.

Sport Mode

The task mode is disabled in Sport Mode. The TYPHOON H PLUS has high reaction sensitivity in Sport Mode. The maximum flight speed of the aircraft is increased to 45 mph (20m/s).

NOTICE: The aircraft's maximum speed and braking distance are significantly increased in Sport mode. A minimum braking distance of 98ft (30m) is required in windless conditions.

NOTICE: The aircraft's responsiveness is significantly increased in Sport mode. A slight stick movement on the remote controller will produce a large travel distance of the aircraft. Be cautious and maintain adequate maneuvering space during flight.



IPS Mode

The TYPHOON H PLUS will automatically activate the IPS or not. When GPS can't be locked, if the flight control activates the IPS, the remote controller will remind that IPS is activated, which indicates the IPS is activated automatically. At the same time, the aircraft can't be switched to Sport Mode, RTL Mode and Task Mode, ONLY remain in IPS Mode even if switching the mode switch.

When using IPS to lock the position of the aircraft, TYPHOON H PLUS can also hover at its current altitude automatically. The IPS is most suitable for indoor flight or without GPS locked. The maximum flight speed is 8.9mph (4m/s)

NOTICE: When flying in door with IPS activated, the OBS AVOID is unavailable.

NOTICE: When using IPS without GPS locked, make sure that the indoor illumination is sufficient. The IPS may not be able to position when the aircraft is flying over highly reflective surfaces or over highly repeated surface texture (such as the same color).

NOTICE: In IPS Mode, the one-key takeoff () and () landing cannot be activated.

RTL Mode

When the Flight Mode selection switch is in the bottom position, TYPHOON H PLUS will be in RTL (also known as Return to Land) Mode.

In RTL Mode the GPS connectivity will fly back TYPHOON H PLUS in a straight line in the direction of the pilots' current location, and automatically land within 13-26ft (4-8m) of the pilot. It can be helpful for pilots that lose orientation during flight. Simply activate RTL Mode until TYPHOON H PLUS automatically moves toward the home position, and once you've confirmed orientation switch back to Angle Mode. If the TYPHOON H PLUS ever loses the link with the ST16S Ground Station it will automatically enter RTL Mode.

NOTICE: If the signal of remote control is lost, TYPHOON H PLUS will automatically return to home point.

NOTICE: If switching on OBS AVOID in RTL Mode, the TYPHOON H plus will avoid the obstacle during RTL mode. The flight speed (only for RealSense Version) will be limited to 8.9mph (4m/s).

Before switching to RTL Mode, press the Setting Calibration button on the right top corner of the screen. Select Aircraft setting icon[] and set a height as the desired altitude, and then RTL Mode can be activated. The flight path is as follows:

REALSENSE TURNED OFF

1. When the flight height of the aircraft is lower than the desired altitude, it will climb to the desired altitude vertically first, then fly back at the current height and descend vertically within 13-26ft (4-8m) of the Home point until it lands automatically.

2. When the flight height of the aircraft is higher than the desired altitude, it will fly back at the current height, and then descend vertically within 13-26ft (4-8m) of the Home point until it lands automatically.

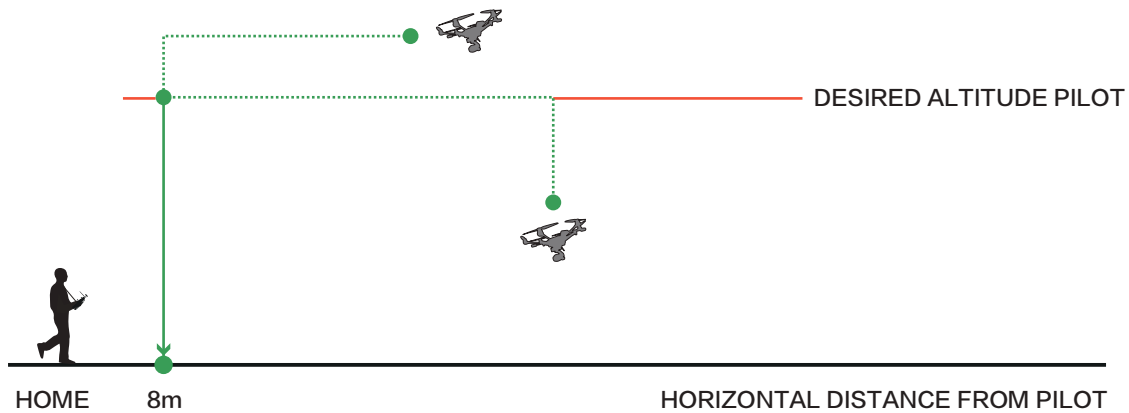

REALSENSE TURNED ON

1. When the flight height of the aircraft is lower than the desired altitude, the aircraft will climb to the desired altitude, meanwhile, it will fly back to the home point, and then descend vertically within 13-26ft (4-8m) of the Home point until it lands automatically.

2. When the flight height of the aircraft is higher than the desired altitude, the aircraft will descend to the desired altitude, meanwhile, it will fly back to the home point, and then descend vertically within 13-26ft (4-8m) of the Home point until it lands automatically.

NOTICE: When the aircraft detects any obstacle, it will avoid and bypass the obstacle first and then fly back to home point as per the above methods.

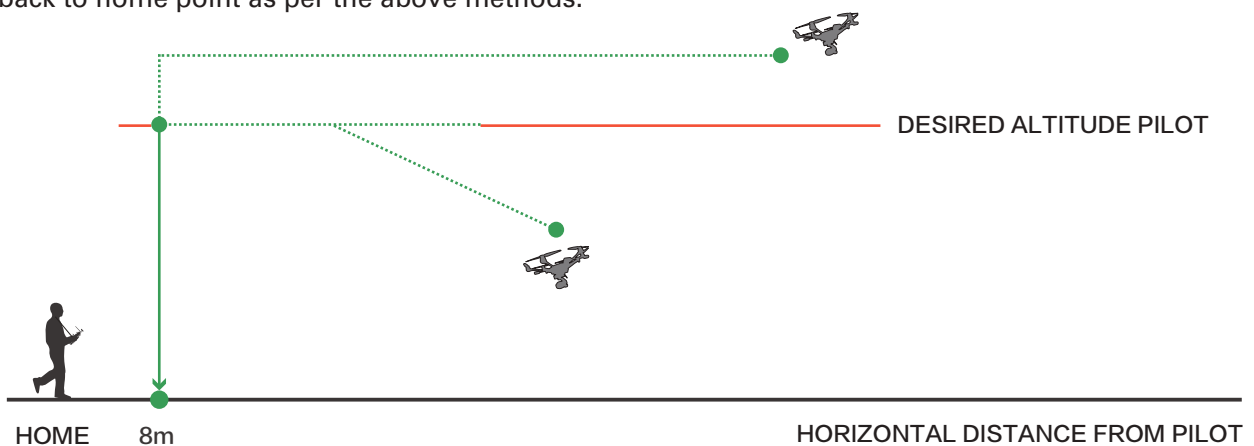

NOTICE: The default home altitude is 20m (65.6ft). But after the home altitude is reset, the latest data will be saved as the new default home altitude.

NOTICE: Users can control pitch, roll and yaw directions during descent.

NOTICE: After the Home Mode is activated, the aircraft will point its nose to the home point automatically. After the aircraft arrives to the home point and begins to descend, it will turn its tail pointing to the pilot.

CAUTION: With OBS. AOID switched off, you must be certain there are no obstacles in the 'Return to Home' flight path otherwise TYPHOON H PLUS may come into contact with them and crash. While TYPHOON H PLUS is in RTL Mode you will have a limited amount of directional control.

WARNING: RTL Mode only works when TYPHOON H PLUS has a suitable GPS signal/lock. If TYPHOON H PLUS loses GPS signal/lock it will switch to Angle (Pilot) Mode automatically.

Task Mode

Tap the icon  on the left bottom of the screen, and then you will enter task modes: CCC, Follow me, Watch Me, Journey, POI, Orbit.

CCC (Curve Cable Cam)

Curve Cable Cam allows you to create an invisible route for TYPHOON H PLUS to fly along. Once the pilot sets the points, TYPHOON H PLUS will fly the set coordinates while remembering the heading.

NOTICE: The direct distance between every two waypoint should be more than 26 feet (8 meters).

Tap the CCC to enter the Curve Cable Cam function. Choose Set waypoints.

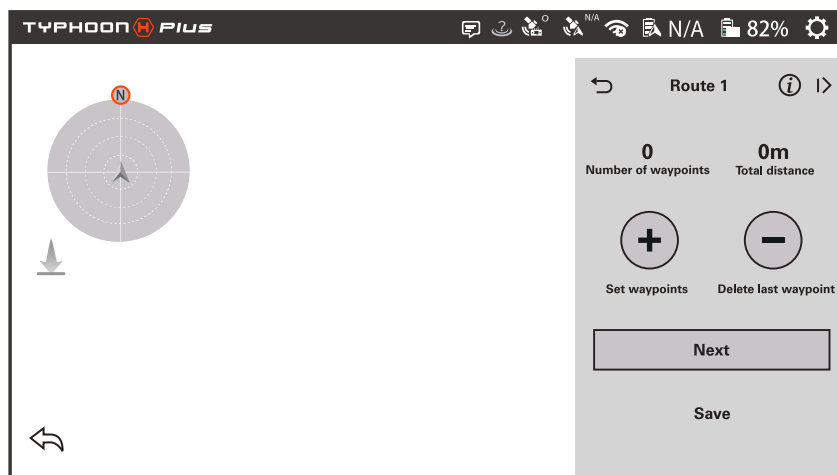

 : Tap '+' to create a new point recording the current flying position.



 : '-' to delete the last point created during the flight.

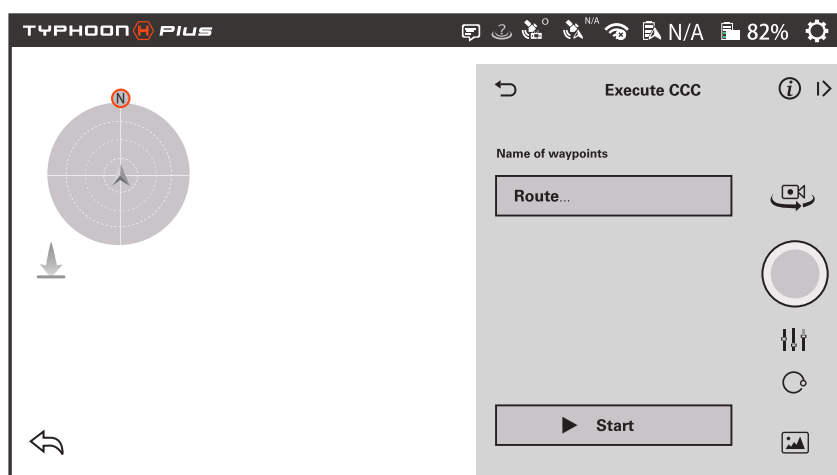

NEXT : Tap the NEXT icon and Execute CCC interface will be entered.



Save: Tap Save and the current route will be saved. The name of waypoints can be defined by the pilot.

Start: Tap Start, TYPHOON H PLUS will fly back to waypoint 1 automatically.

[]: When the pilot taps the [], the icon will become [] and the CCC function will be paused.

When tapping it again, the [] will become [], the copter will continue the CCC function. The pilot can exit the function by tapping [] icon or switching flight mode.

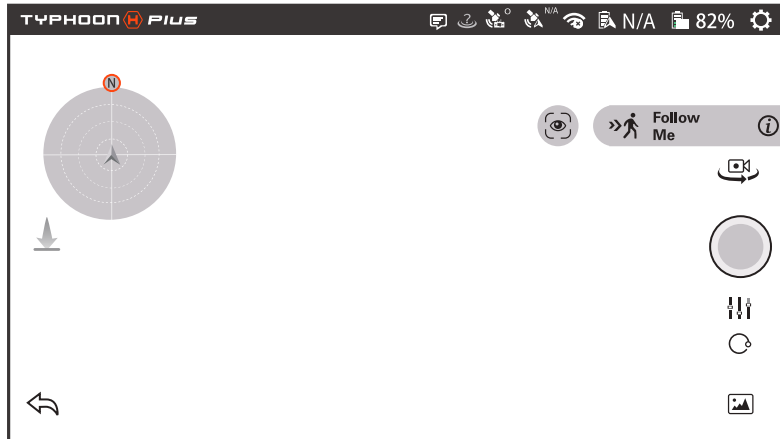

Follow Me

The Follow Me function allows TYPHOON H PLUS to follow the pilot, adjusting its location to the location of the ST16S Ground Station. This function is enabled when ST16S's GPS positioning has been acquired, and TYPHOON H PLUS is using shared GPS signal with the ST16S Ground Station.



Watch me

Watch me enables the camera to keep tracking the remote controller no matter where and how it moves as the camera can automatically tilt its angle according to the controller.

Press the icon  in the Follow Me function, and it will turn green . Follow me displayed in the right bar will display 'Watch Me'.

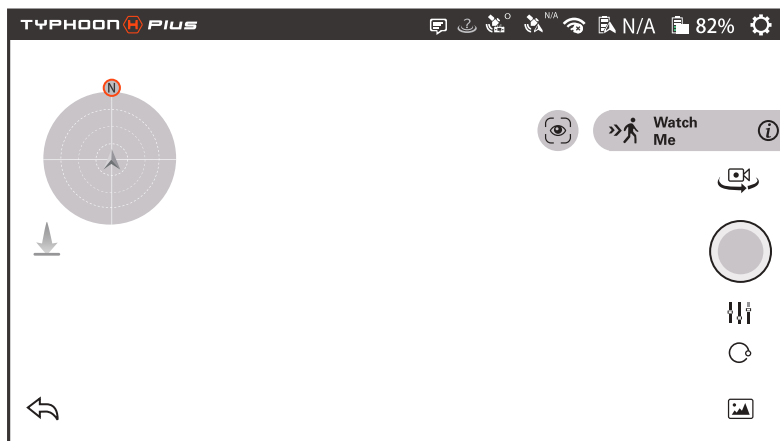

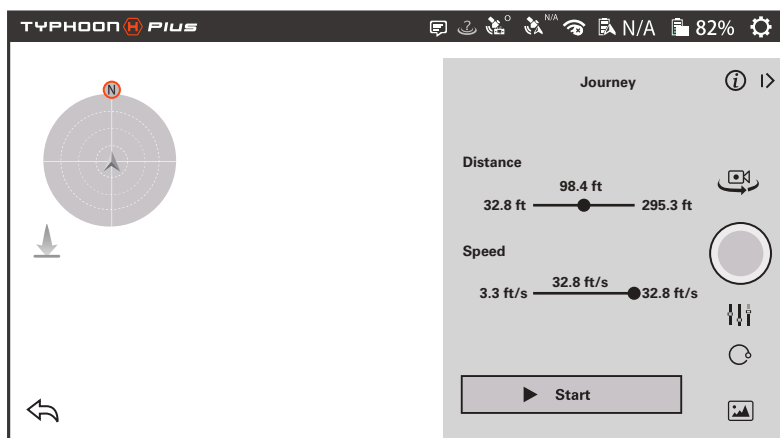

Journey

Journey function enables TYPHOON H PLUS to capture the perfect aerial selfie or any scenic shot and record videos much easier and faster. Depending on the pilot's desired setting, TYPHOON H PLUS will go up, out and return.



Distance can be adjusted manually between 32.8ft and 295.3ft, and speed between 3.3 ft/s and 32.8 ft/s.

 : Taking photos or recording video can be switched by tapping() and () icons.

POI

Point of Interest allows the pilot to select a subject they would like to orbit and have TYPHOON H PLUS orbit that subject autonomously.

NOTICE: When the voltage of the aircraft is lower than 30%, the functions under the TASK mode won't be activated.

Tap the () icon to set a center point and set an ideal radius by controlling the joystick. The height and radius data will be calculated automatically and indicated. Press the Start icon and push the Aileron/Roll control stick, the aircraft will begin to execute POI. The Start icon will become the Pause icon. The pilot can pause the the task by tapping it.

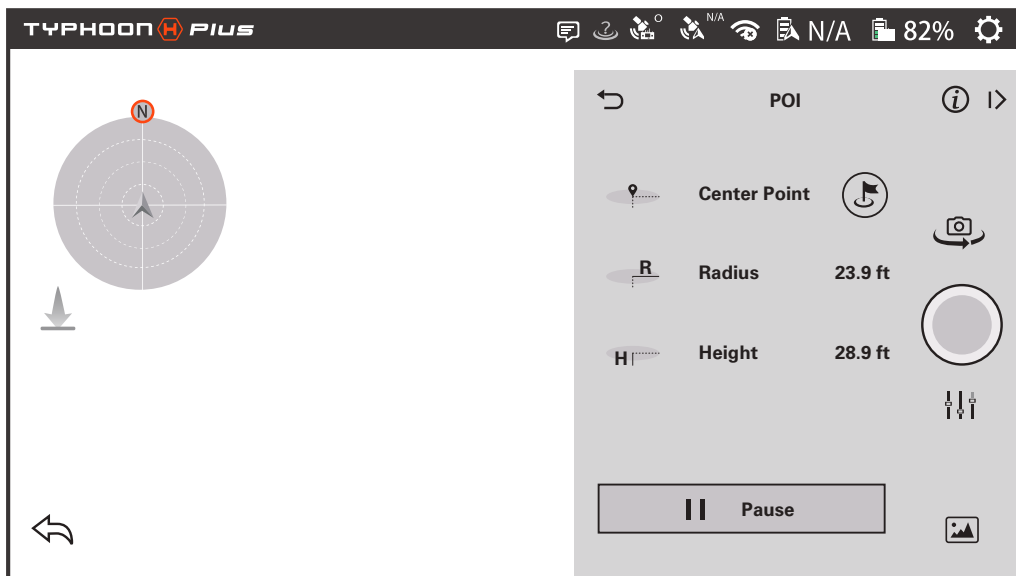

Orbit

When Orbit Me is enabled, TYPHOON H PLUS flies a circular path around the pilot. Press ORBIT to enter the Orbit me function.

The center point will be the position where the ST16S is by default. Set an ideal radius by controlling the joystick. The height and radius data will be calculated automatically and indicated. Press the Start icon and push the Aileron/Roll control stick, the aircraft will begin to execute POI. The Start icon will become Pause icon. The pilot can pause the the task by tapping it.

Landing

There are three ways to land the aircraft:

1. Position the TYPHOON H PLUS above the area where you would like to land. Lower down the retractable landing gear, and then slowly lower the left-hand stick to below the center position. TYPHOON H PLUS will descend slowly and land.
2. Activate Home Mode and TYPHOON H PLUS will automatically fly itself back to the home point and land.
3. Press the icon (), then slide the sliding block, and the aircraft will land automatically.

WARNING: Always land as soon as possible after the first low level voltage battery warning, or land immediately after the second level low voltage battery warning by the Motor LED Status Indicators flashing rapidly.

After Landing

ALWAYS turn off TYPHOON H PLUS BEFORE turning off the ST16S Ground Station. Then remove the battery from TYPHOON H PLUS and allow it to cool to ambient/room temperature before recharging.

NOTICE: If the signal of the remote control is lost, TYPHOON H PLUS will automatically return to the home point.

Remote Controller

ST16S Charging

Charge the ST16S battery by using supplied USB cable and inserting it into the Micro USB port on the charger. It will take approximately five hours to charge a fully discharged battery.

WARNING: Do not leave the battery in the charger after the battery is fully charged.

NOTICE: When the remote controller is charged, the charging status can be viewed by double-clicking the screen.

Flight Control

The default flight control is known as Mode 2. The left stick controls the aircraft's altitude and heading, while the right one controls its direction movements.

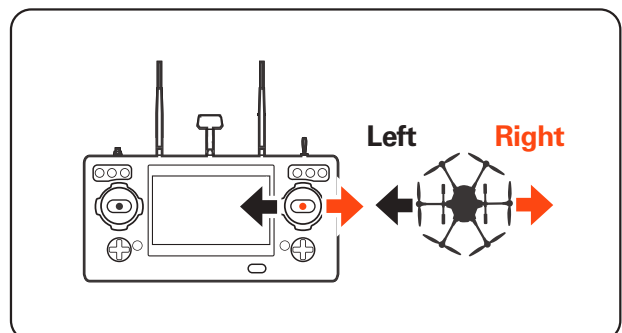
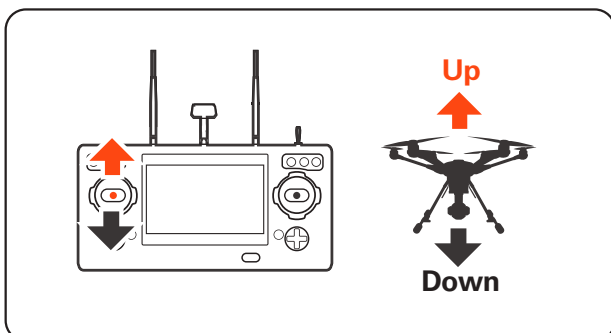
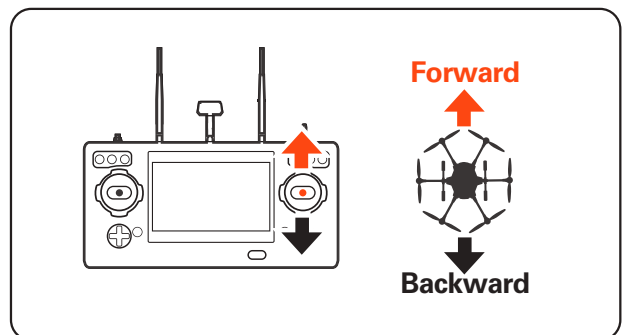
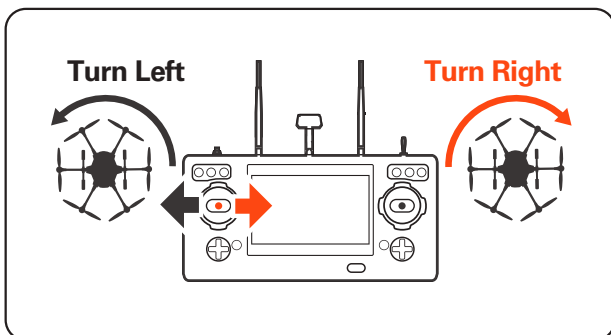

Proportional Control Rate Slider

The Proportional Control Rate Slider located on the right side of the ST16S Ground Station allows you to set the overall climb/descend and directional control rates.

Fly low and slow initially. Slow (Low Speed) position, the lowest control rates, is ideal for precision flight. High-speed (High Speed) position is used when transiting broad areas.

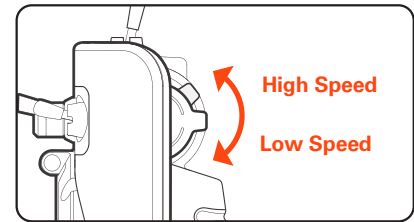

Camera Control

Gimbal Camera Tilt Control

There is a gimbal tilt mode switch on ST16S labeled "S1." When the switch is in up/middle position, the C23 (or other gimbal system) gimbal camera is in Angle Mode. Use the slider (C) on the under-left side of the ST16S to set the tilt position of the gimbal camera. When the S1 is in the bottom position, the gimbal camera is in Velocity Mode. When the slider (C) is in the middle position, it means the velocity rate is 0 for the C23, disabling tilt. When the slider (C) is above the middle position, the C23 will enable upward tilt/angle. When the slider (C) is below the middle position, the C23 will enable downward tilt. The distance between the slider (C) and the middle position determines the tilt speed, the further distance, the faster the tilt speed.

CAUTION: Video recording must be stopped to take still photos. It will take approximately 1-2 seconds to capture a still photo and before another image may be taken.

CAUTION: ALWAYS stop recording video before powering down TYPHOON H PLUS to avoid loss of video data.



NOTICE: Only when in Velocity mode may the gimbal camera be tilted upwards 15° maximum.

Gimbal Camera Pan Control

The gimbal pan mode switch on ST16S (S2) enables the Follow Mode. When the switch position is UP, the gimbal camera is in Follow Mode. The pan control of the gimbal camera is disabled when the switch position is UP. The gimbal camera will adjust its pan direction per the aircraft's movements. When the switch is in the middle position, the gimbal camera is in Follow Pan Controllable Mode, the gimbal camera will adjust its pan direction per the aircraft's movements. Use the Pan Control Knob to set the pan position of the gimbal camera. When the switch position is down, the gimbal camera is in Global Mode. The pan direction of the gimbal camera will be fixed regardless of the aircraft's movements. Use the Pan Control Knob to set the pan position of the gimbal camera.

Appendix

Upgrading the Firmware

STEP 1: Tap the system settings icon [] on the right top of the screen, and then select the icon (). Scroll down and tap Check for updates.

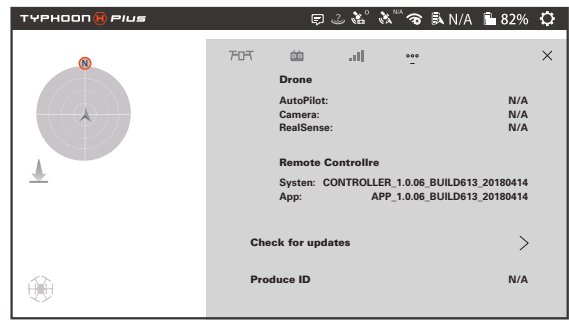



STEP 2: Choose an available WiFi, input the password and tap OK.



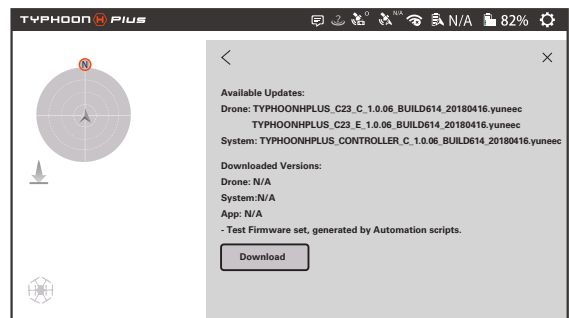

STEP 3: When Available Updates displayed on the screen, tap the Download icon. Wait for a few minutes till a 100% completed circle is displayed, which means the download completes.

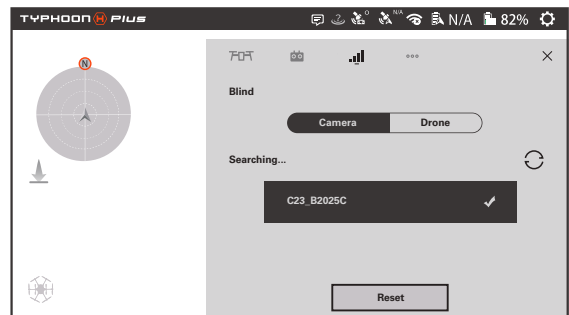

STEP 4: Switch on the aircraft first, and then return back to the main interface of the screen. Find system settings icon [], tap the icon [], and then choose the C23 gimbal camera.



STEP 5: Return back to the main interface, repeat the step 1 (tap the system settings icon [] on the right top of the screen, and then select the icon (). Scroll down and tap Check for updates.) , and tap Update icon to upgrade the gimbal camera.

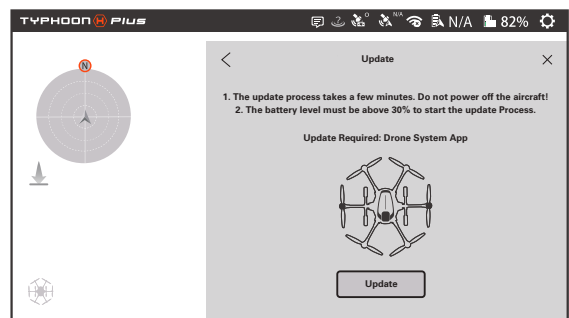

NOTICE: The battery level must be above 30% to start the update process.

NOTICE: It requires a SD card in the camera when updating the gimbal camera.

After the above steps, wait for a few minutes until the aircraft, the gimbal, the camera and the remote control give the following hints in turn: you will hear the aircraft emit the acknowledgement tone, the same one you hear when you switch the system on; the gimbal completes its initialization; the LED indicator status of C23 camera changes from blinking purple slowly to being solid green; the remote control restarts and automatically returns back to its main interface, which indicates that the updating process is completed and successful.

LED Status Indication

All the LEDs mentioned are numbered as shown.
The color of the icon indicates the color of the LED.

- ☀ indicates the LED flashing.
- indicates the LED solid on.

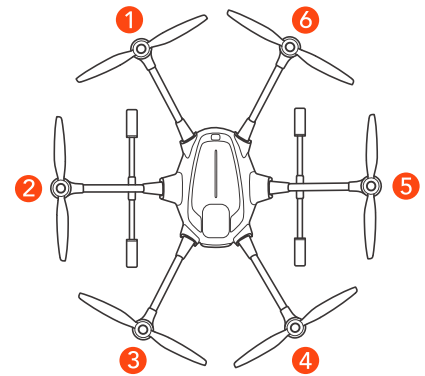

| STATUS | 2 | 5 | 1 | 6 | 3 | 4 |
|---|-------------------------------------|---|---|---|---|---|
| Initiate Compass Calibration | ☀ 2 5 → 3 6 → 4 1 → 5 2 → 6 3 → 1 4 | | | | | |
| Accelerometer/ Gyro Calibration Completed | | | ☀ | | | |
| During Initialization | | | ● | | | |
| Rotor Abnormal Alarming | | | ● | | | |
| The Aircraft is in Binding Mode | | | ☀ | | | |
| Low Voltage Battery Warning | | | ☀ | | | |
| Binding Failed | ● | ● | ○ | | | ☀ |
| Calibration Failed | ● | ● | ○ | | | ☀ |
| The Aircraft is in Sport Mode | ● | ● | ○ | | | ● |
| The Aircraft is in Angle Mode (without GPS lock) | ● | ● | ○ | | | ☀ |
| The Aircraft is in Angle Mode (with GPS lock) | ● | ● | ○ | | | ● |
| The Aircraft is in RTL Mode | ● | ● | ○ | | | ● |
| The Aircraft is in Task Mode | ● | ● | ○ | | | ● |
| The Aircraft is in IPS Mode | ● | ● | ○ | | | ● |
| First / Second Level Low Voltage Battery Warning | ● | ● | ○ | | | ☀ |
| Compass Alarming | ● | ● | ○ | | | ☀ |
| The Aircraft is in No-Fly Zone | ● | ● | ○ | | | ☀ |
| OBS. Function Activated | ● | ● | ☀ | | | ● |

Disclaimer

Yuneec International (China) Co., Ltd shall not be held liable for any damage, injury or for use of the product in violation with legal regulations, especially in the following circumstances:

Damage and/or injury as well violation of legal regulations resulting from a failure to comply with the operating instructions or the instructions at www.yuneec.com, product information, user manual and other legally binding information;

Damage and/or injury as well violation of legal regulations brought about by the influence of alcohol, drugs, medication or other narcotics which may impact on the concentration of the user;

The same applies to illnesses effecting the concentration of the user (dizziness, tiredness, nausea etc.) or other factors compromising mental and physical capabilities.

Intentionally caused damage, injury or violation of legal regulations;

Any request for compensation caused by an accident resulting from use of the product;

Malfunction of the product caused by retrofitting or replacement with components which did not come from Yuneec;

Damage and/or injury caused by the use of replica parts (non-original parts);

Damage and/or injury as well as violation of legal regulations caused by incorrect operation or misjudgment;

Damage and/or injury caused by damaged spare parts or not using original Yuneec spare parts;

Damage and/or injury caused by unauthorized change settings and/or parameters;

Damage and/or injury caused by modify and/or add parts;

Damage and/or injury as well as violation of legal regulations caused by ignoring the low voltage battery warning;

Damage and/or injury caused by knowingly and negligibly flying with a damaged model or one which is unfit to fly, e.g. due to dirt, water penetration, coarse particles, oil or a model which has not been correctly or completely assembled or if the main components exhibit visible damage, defects or missing parts;

Damage and/or injury as well as violation of legal regulations caused by use of the product in a no-fly zone, e.g. next to an airfield, above a motorway or a natural conservation area;

Damage and/or injury as well as violation of legal regulations caused by operating the model in a magnetic field (e.g. high voltage lines, electricity/ transformer stations, radio towers, mobile phone masts etc.), a strong wireless signal environment, no-fly zones, poor visibility and in the event of vision impairments or other impacts on the pilot which are left unchecked etc;

Damage and/or injury brought about through a violation of the legal regulations for operating the model, in unsuitable weather conditions, e.g. rain, wind, snow, hail, storms, hurricanes etc;

Damage and/or injury as well as violation of legal regulations caused by force majeure, e.g. collision, fire, explosion, flooding, tsunami, landslide, avalanche, earthquake or other forces of nature;

Damage and/or injury as well as violation of legal regulations caused by the illegal or immoral use of the model, e.g. capturing videos or recording data which infringes upon/harms the privacy of other people;

Damage and/or injury as well as violation of legal regulations caused by incorrect use of the batteries, protection systems, chargers or aircraft;

Consequential damage caused by the incorrect operation of any kind of system components and accessory parts, especially memory cards, whereby image or video material from the camera can become defect;

Any non-compliance with legal obligations, personal injury, material damage and environmental damage caused by use and a failure to comply with the local laws and regulations;

Damage and/or injury as well as violation of legal regulations caused by hazardous use without sufficient practical experience;

Damage and/or injury as well as violation of legal regulations caused by flying in legally defined no-fly zones.

Further losses which do not fall within the scope of use defined by Yuneec as improper.

This product is designed for both professional use and personal private use. The national and international laws and regulations in force as the time of taking off must be adhered to.

Collection and Processing of Data

Yuneec may collect navigation information such as GPS data to help improve our products.

We may also collect Depth Map information and Infrared Image information from your drone delivered to our service center for repair and maintenance service or any other service.

We may also collect other information such as device information, server log information, etc. We may also collect personal information used in registration if you choose to become a registered user and any other information user provided to Yuneec. We may also collect information which user send to other users, and the recipients and senders of such information.

We reserve the right to disclose your information if required to do so by law or in the good-faith belief that such disclosure is needed to comply with applicable laws, for example in response to a court order, judicial subpoena, warrant or request from government, or otherwise cooperating with government agencies or law enforcement.

We also reserve the right to disclose your information that we believe in good faith is necessary or appropriate to: (i) protect ourselves or others from fraudulent, unlawful, or abusive activities; (ii) take precautions against potential liability; (iii) protect the security of the Yuneec Apps embedded into or downloaded onto your drone or any associated equipment and services; (iv) protect the legal rights of ourselves or any others.

Any information we collected maybe disclosed or transferred to an acquirer, successor or assignee as part of any potential merger, acquisition, debt financing or other activities that involves transfer of business assets.

We may make the aggregated non-personal information of the users available to third parties for various purposes, including (i) complying with various report obligations; (ii) marketing efforts; (iii) analyzing product safety; (iv) understanding and analyzing our users' interests, habits, usage pattern for certain functionalities, services, content, etc.

Battery Warnings and Usage Guidelines

WARNING: Lithium Polymer (LiPo) batteries are significantly more volatile than alkaline, NiCd or NiMH batteries. All instructions and warnings must be followed exactly to prevent property damage and/or serious injury as the mishandling of LiPo batteries can result in fire. By handling, charging or using the included LiPo battery you assume all risks associated with LiPo batteries. If you do not agree with these conditions please return the complete product in new, unused condition to the place of purchase immediately.

You must always charge the LiPo battery in a safe, well-ventilated area away from flammable materials. Never charge the LiPo battery unattended at any time. When charging the battery, you must always remain in constant observation to monitor the charging process and react immediately to any potential problems that may occur.

After flying/discharging the LiPo battery you must allow it to cool to ambient/room temperature before recharging.

To charge the LiPo battery you must use only the included charger or a suitably compatible LiPo battery charger. Failure to do so may result in a fire causing property damage and/or serious injury.

If at any time the LiPo battery begins to balloon or swell, discontinue charging or discharging immediately. Quickly and safely disconnect the battery, then place it in a safe, open area away from flammable materials to observe it for at least 15 minutes. Continuing to charge or discharge a battery that has begun to balloon or swell can result in a fire. A battery that has ballooned or swollen even a small amount must be removed from service completely.

Do not over-discharge the LiPo battery. Discharging the battery too low can cause damage to the battery resulting in reduced power, flight duration or failure of the battery entirely. LiPo cells should not be discharged to below 3.0V each under load.

Store the LiPo battery at room temperature and in a dry area for best results.

When charging, transporting or temporarily storing the LiPo battery the temperature range should be

from approximately 40–120 ° F (5–49 ° C). Do not store the battery or aircraft in a hot garage, car or direct sunlight. If stored in a hot garage or car the battery can be damaged or even catch fire.
Never leave batteries, chargers and power supplies unattended during use.
Never attempt to charge low voltage, ballooned/swollen, damaged or wet batteries.
Never allow children under 14 years of age to charge batteries.
Never charge a battery if any of the wire leads have been damaged or shorted.
Never attempt to disassemble the battery, charger or power supply.
Never drop batteries, chargers or power supplies.
Always inspect the battery, charger and power supply before charging.
Always ensure correct polarity before connecting batteries, chargers and power supplies.
Always disconnect the battery after charging.
Always terminate all processes if the battery, charger or power supply malfunctions.

General Safety Precautions and Warnings

WARNING: Failure to use this product in the intended manner as described in the quick start guide and instruction manual can result in damage to the product, property and/or cause serious injury. A Radio Controlled (RC) multirotor aircraft, APV platform, drone, etc. is not a toy! If misused it can cause serious bodily harm and damage to property.

WARNING: As the user of this product you are solely and wholly responsible for operating it in a manner that does not endanger yourself and others or result in damage to the product or the property of others.

Keep your hands, face and other parts of your body away from the spinning propellers/rotor blades and other moving parts at all times. Keep items that could impact or become entangled away from the propellers/rotor blades including debris, parts, tools, loose clothing, etc.

Always operate your aircraft in open areas that are free from people, vehicles and other obstructions.

Never fly near or above crowds, airports or buildings.

To ensure proper operation and safe flight performance never attempt to operate your aircraft nearby buildings or other obstructions that do not offer a clear view of the sky and can restrict GPS reception.

Do not attempt to operate your aircraft in areas with potential magnetic and/or radio interference including areas nearby broadcast towers, power transmission stations, high voltage power lines, etc.

Always keep a safe distance in all directions around your aircraft to avoid collisions and/or injury. This aircraft is controlled by a radio signal subject to interference from many sources outside your control. Interference can cause momentary loss of control.

To ensure proper and safe operation of the automatic landing function in Return Home Mode you must start the motors with the aircraft in an open space and achieve a proper GPS lock.

Do not attempt to operate your aircraft with any worn and/or damaged components, parts, etc. including, but not limited to, damaged propellers/rotor blades, old batteries, etc.

Never operate your aircraft in poor or severe weather conditions including heavy winds, precipitation, lightning, etc.

Always begin to operate your aircraft with a fully charged battery. Always land as soon as possible after the first level low voltage battery warning or land immediately after the second level low voltage battery warning.

Always operate your aircraft when the voltage of the battery in the transmitter/personal ground station is in a safe range (as indicated by the LED status indicator light of the transmitter/personal ground station).

Always keep the aircraft in clear line of sight and under control, and keep the transmitter/personal ground station powered on while the aircraft is powered on.

Always move the throttle control stick down fully and turn off the power in the event the propellers/rotor blades come into contact with any objects.

Always allow components and parts to cool after use before touching them and flying again.

Always remove batteries after use and store/transport them per the corresponding guidelines.

Avoid water exposure to all electronic components, parts, etc. not specifically designed and protected for use in water. Moisture causes damage to electronic components and parts.

Never place any portion of the aircraft or any related accessories, components or parts in your mouth as doing so could cause serious injury or even death.

Always keep chemicals, small parts and electronic components out of the reach of children.

To ensure safe fly, it is recommended to install the propeller protectors when operating the aircraft indoors or nearby crowds.

Carefully follow the instructions and warnings included with this aircraft and any related accessories, components or parts (including, but not limited to, chargers, rechargeable batteries, etc.).

Camera Usage Warnings

NOTICE

For the latest product information, please check our official website: www.yuneec.com.

WARNING

Do not expose the lens of the camera to extreme light sources.

Do not operate the camera in the rain or in environments with high humidity.

Do not try to repair the camera. Repairs must go to an authorized service center.

WARNING

Read the entire instruction manual to become familiar with the features of the product before operating.

Do not use with incompatible components or alter this product in any way outside of the instructions provided by Yuneec.

Failure to use this product in the intended manner as described in instruction manual can result in damage to the product, property and/or cause serious injury.

Indoor Position System Precautions

The visual positioning system is susceptible to light intensity and surface texture while the Ultrasonic may fail to measure the distance on certain sound-absorbing materials, so please take extreme care when using the visual positioning function in the following occasions:

When the TYPHOON H PLUS is flying rapidly in low attitude, the visual positioning system may not be able to position;

When the TYPHOON H PLUS is flying over surfaces of pure color (such as pure black or pure white), the visual positioning system may not be able to position;

When the TYPHOON H PLUS is flying over highly reflective surfaces, the visual positioning system may not be able to position;

When the TYPHOON H PLUS is flying over surfaces of waters or transparent objects, the visual positioning system may not be able to position;

When the TYPHOON H PLUS is flying over surfaces of moving objects(such as above large crowds or strong wind blowing over grass or shrubs), the visual positioning system may not be able to position;

When the TYPHOON H PLUS is flying over scenes which are rapidly changed or exposed to strong light, the visual positioning system may not be able to position;

When the TYPHOON H PLUS is flying over surfaces which are particularly bright (light intensity higher than 10,000 lux) or dark (light intensity lower than 10 lux), the visual positioning system may not be able to position;

When the TYPHOON H PLUS is flying over surfaces of ultrasound absorbent material (such as thick blankets), the visual positioning system may not be able to position;

When the TYPHOON H PLUS is flying over surfaces of particularly sparse texture, the visual positioning system may not be able to position;

When the TYPHOON H PLUS is flying over surface texture that is highly repeated (such as small grid

bricks of the same color), the visual positioning system may not be able to position.

Make sure the camera lens is clear and without stain, otherwise the visual positioning system may not be able to position.

The visual positioning system can be used when the TYPHOON H PLUS is flying within 4 meters over ground.

Visual Positioning System may fail to work in such environments: on the surface of water, in dark environment or over ground without clear texture. Ensure adequate light source and rich ground texture in surrounding environment when using the visual positioning system.

When using the visual positioning system, stay it away from animals because it will issue ultrasound and cause animal anxiety.

FCC Statement

This equipment has been tested and found to comply with the limits for Part 15 of the FCC rules. These limits are designed to provide reasonable protection against harmful interference in a residential installation. This equipment generates, uses and can radiate radio frequency energy and, if not installed and used in accordance with the instructions, may cause harmful interference to radio communications. However, there is no guarantee that interference will not occur in a particular installation. If this equipment does cause harmful interference to radio or television reception, which can be determined by turning the equipment off and on, the user is encouraged to try to correct the interference by one or more of the following measures:

- Reorient or relocate the receiving antenna.
- Increase the separation between the equipment and receiver.
- Connect the equipment to an outlet on a circuit different from that to which the receiver is connected.
- Consult the dealer or an experienced radio/TV technician for help.

This device complies with part 15 of the FCC rules. Operation is subject to the following two conditions: This device may not cause harmful interference, and (2) this device must accept any interference received, including interference that may cause undesired operation.

RF Exposure Warning

This equipment must be installed and operated in accordance with provided instructions and the antenna(s) used for this transmitter must be installed to provide a separation distance of at least 20 cm from all persons and must not be co-located or operating in conjunction with any other antenna or transmitter. End-users and installers must be provided with antenna installation instructions and transmitter operating conditions for satisfying RF exposure compliance.

IC Radiation Exposure Statement for Canada

This device complies with Industry Canada license-exempt RSS standard (s). Operation is subject to the following two conditions: (1) this device may not cause interference, and (2) this device must accept any interference, including interference that may cause undesired operation of the device. Le présent appareil est conforme aux CNR d'Industrie Canada applicables aux appareils radio exempts de licence. L'exploitation est autorisée aux deux conditions suivantes : (1) l'appareil ne doit pas produire de brouillage, et (2) l'utilisateur de l'appareil doit accepter tout brouillage radioélectrique subi, même si le brouillage est susceptible d'en compromettre le fonctionnement.

This equipment complies with IC RSS-102 radiation exposure limit set forth for an uncontrolled environment. Cet équipement respecte les limites d'exposition aux rayonnements IC définies pour un envi-

NCC Warning Statement

1. 根據低功率電波輻射性電機管理辦法：

第十二條 經型式認證合格之低功率射頻電機，非經許可，公司、商號或使用者均不得擅自變更頻率、加大功率或變更原設計之特性及功能。

第十四條 低功率射頻電機之使用不得影響飛航安全及干擾合法通信；經發現有干擾現象時，應立即停用，並改善至無干擾時方得繼續使用。前項合法通信，指依電信法規定作業之無線電通信。低功率射頻電機須忍受合法通信或工業、科學及醫療用電波輻射性電機設備之干擾。

2. 根據低功率射頻電機技術規範 4.7.9.1 應避免影響附近雷達系統之操作。

CE Warning Statement

This device meets the EU requirements on the limitation of the general public to electromagnetic fields by way of health protection.

EU Operation Frequency (The Maximum Transmitted Power)

ST16S Remote Controller:

2.4G: 2405-2475MHz (20dBm);

2.4G Wifi: 2412-2472MHz (20dBm);

5G Wifi: 5560-5580MHz (27dBm), 5680-5700MHz (27dBm)

TYPHOON H PLUS:

2.4G:2405-2475MHz (20dBm)

C23:

5G Wifi: 5560-5580MHz (27dBm), 5680-5700MHz (27dBm)

EU Compliance Statement

Hereby, Yuneec International (China) Co., Ltd. declares that this device is in compliance with the essential requirements and other relevant provisions of the RED Directive 2014/53/EU. The full text of the EU Declaration of Conformity is available at the following internet address: <http://yuneec/de-downloads>
Please visit the address above and enter corresponding product page.

YUNEEK