

DOBBY

User Manual V1.6

2016.10

Contents

Legend	1
Symbols	1
Reading Suggestions.....	1
Downloading the App	1
Product Profile	2
Introduction	2
Features Highlights.....	2
Aircraft Diagram	3
Aircraft	5
Aircraft Profile.....	5
On/Off Switch and Power Indicator.....	5
Aircraft Status Indicator.....	5
GPS Positioning.....	6
Optic Flow and Ultrasonic Positioning	6
Flight Record.....	7
Propeller	7
Battery	9
Using the Battery	9
Checking the Battery Level.....	10
Charging the Battery.....	10
Camera.....	12
Micro-USB Port.....	12
Reset Button	12
App	14
App Profile.....	14
App Main Interface.....	14
App Settings.....	18
Media Library	20
Photos.....	20
Videos	22
Flying/Shooting	23
Flight Environment Requirements	23

Flight Restrictions.....	24
Preflight Checklist	24
Calibrating the Compass.....	24
Flight Protection	26
Connecting the Aircraft to Do.Fun.....	26
Takeoff/Landing.....	27
Flight Control.....	27
Motion Sensing Method	27
Swipe Screen Method.....	29
Free Sticks Method.....	30
Safe Sticks Method.....	32
Taking Photos/Video Recording.....	32
Taking Photos	32
EIS	33
Conventional Video Recording	33
“More Features”	34
Short Video (Only under Outdoor GPS Positioning)	34
Orbit (Only under Outdoor GPS Positioning)	36
Target Tracking (Only under Outdoor GPS Positioning)	38
Face Tracking	40
Return to Home (Only under Outdoor GPS Positioning)	41
Somersault.....	42
Voice Control.....	42
Emergency Shutdown.....	42
Appendix 1 Specifications	43
Appendix 2 Compliance Information	46

Legend

Symbols



Reading Suggestions

ZEROTECH has provided the following manuals for DOBBY users:

In the Box

Battery Safety Instructions

Disclaimer

DOBBY Quick Start Guide

DOBBY User Manual

To learn how to use DOBBY, we suggest you read the provided manuals in this order: *In the Box*, *Battery Safety Instructions*, *Disclaimer* and then *DOBBY Quick Start Guide*. If you want to learn more, please read *DOBBY User Manual*.

Downloading the App

Before using this product, you need to download and install the Do.Fun app. You can scan the following QR codes, or search for Do.Fun in App Store or Google Play.

Do.Fun supports Android 4.3 and later versions, iOS 8.4 and later versions.



iOS



Android

Product Profile

This section will introduce DOBBY's features and the names of DOBBY's structural components.

Introduction

DOBBY is a portable and easy-to-use drone for selfie. It consists of the aircraft itself and an accompanying app.

Through using the app, you can control DOBBY's flight, take photos and record videos. The app also allows you to control DOBBY by voice commands, earphones and other methods simply and easily.

Features Highlights

In order to give you a convenient and safe selfie experience, DOBBY has various great features:

Accompanying App

The app is specifically developed for DOBBY and is really simple to use. It can be used as a remote controller for flight control and photo & video shooting.

Indoor Flight

DOBBY uses the optic flow and ultrasonic positioning system to support indoor flight. You can also enjoy it indoors, free of the no-fly zone restrictions

High Definition Photo & Video Shooting

DOBBY is equipped with a professional high definition camera that supports 4208×3120 photo shooting and 1920×1080 video shooting.

EIS (Electronic Image Stabilisation)

After EIS, your 4K video footages become 1080p high definition videos. The videos won't be blurry even if you're flying during recording.

10s Auto-Track Short Video ("Short Video" for short)

Allow you to zoom in and out just like in films, the 10s auto-track video shooting turns you into a director for 10 seconds.

Target Tracking

DOBBY can automatically follow and record video on the moving target you've chosen.

Face Tracking

Automatically follow and record video on the moving face you've chosen.

Orbit

Automatically fly and record video around a certain point with a certain radius and at a certain altitude.

Palm Takeoff, Palm Landing

DOBBY can take off from and land safely in the palm of your hand.

Return to Home

After outdoor flight, DOBBY can return to you by just one tap on screen.

Voice Control

You can give voice commands through the app to control DOBBY's flight and photo & video shooting.

One-Key Sharing

Directly share your photos & Videos with your friends on SNS.

Aircraft Diagram

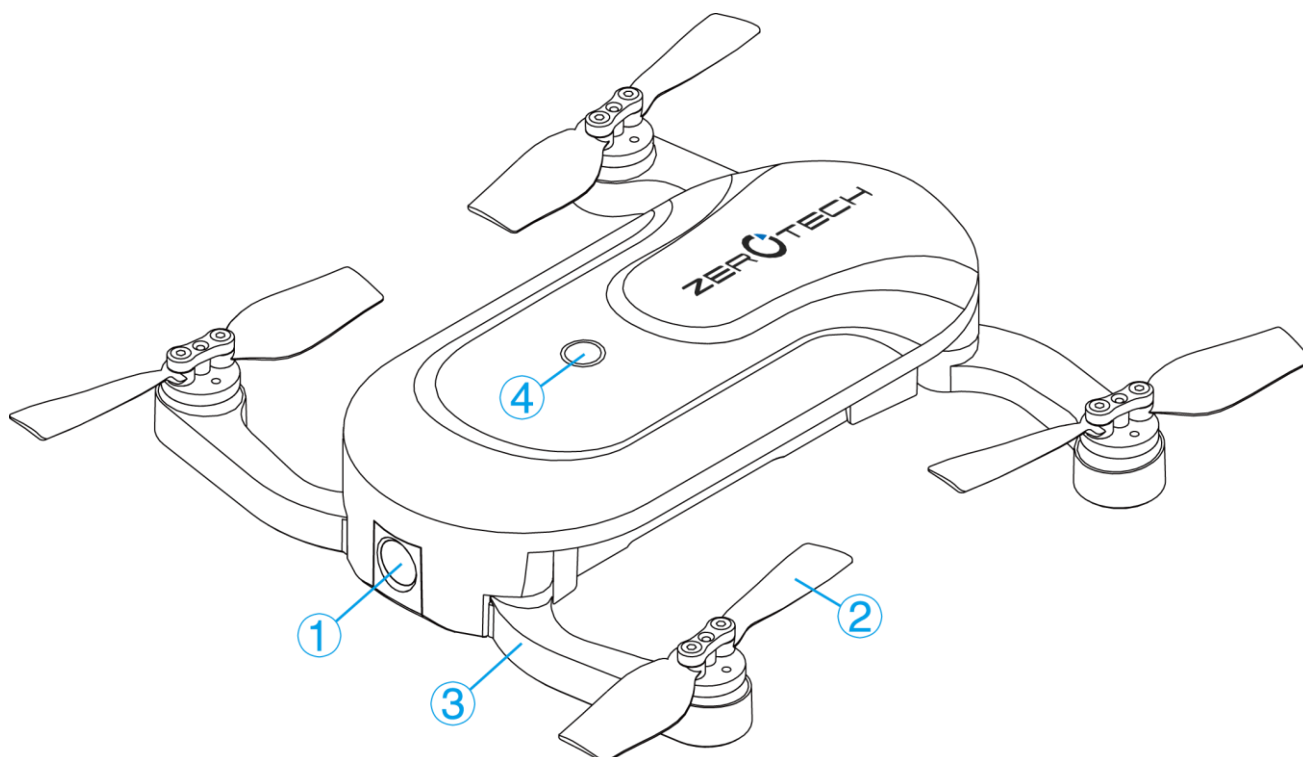

1. Camera

2. Propeller

3. Arm

4. On/Off Switch, Power Indicator

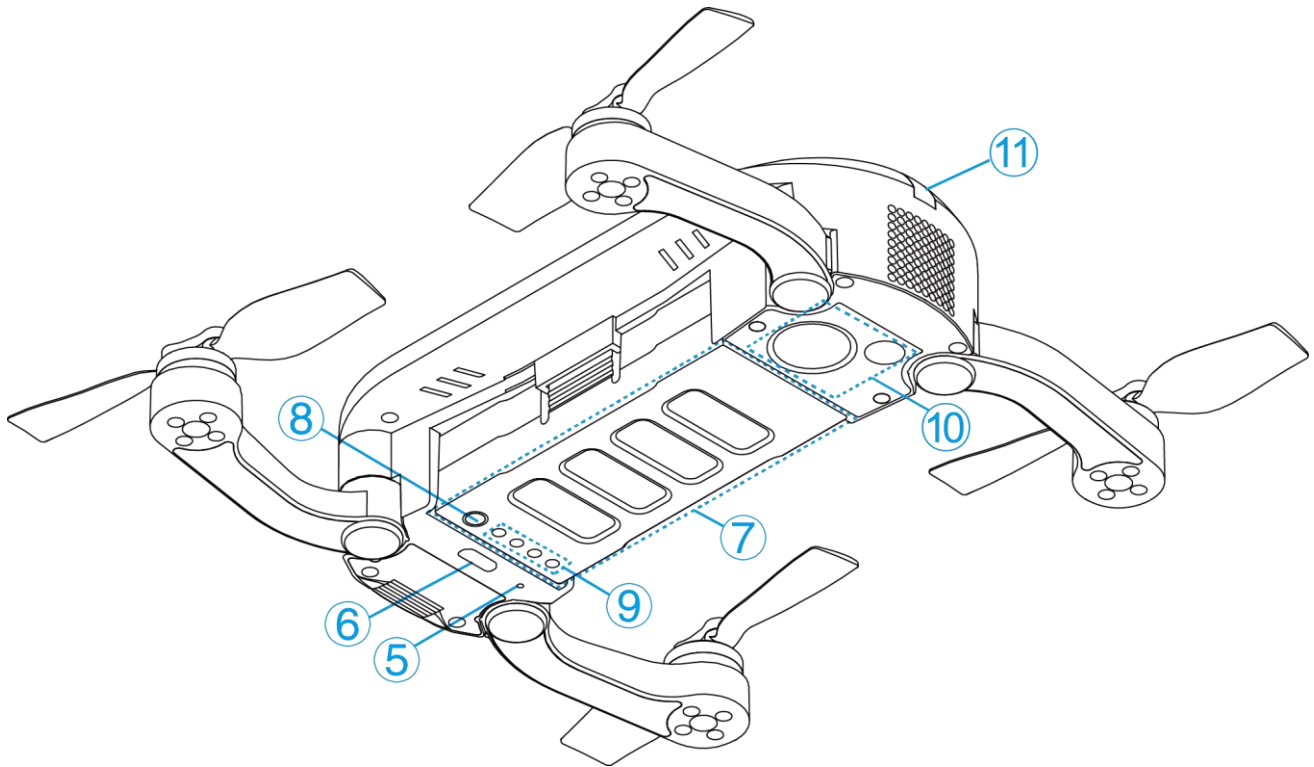

5. Reset Key

6. Micro-USB Port

7. Battery

8. Battery Level Switch

9. Battery Level Indicator

10. Optic Flow and Ultrasonic Positioning Module

11. Aircraft Status Indicator

Aircraft

Aircraft Profile

DOBBY mainly consists of the flight system, the positioning system, the communication system, the power supply system and the camera system.

This section will explain the functions of each of the parts.

On/Off Switch and Power Indicator

The On/Off Switch has an inbuilt Power Indicator.







Hold the On/Off Switch for 3 seconds. Wait until the Power Indicator starts flashing blue, then remove your finger and DOBBY will switch on. After a few seconds, DOBBY will make a noise alerting you that the ESC has turned on.





After connecting to the app, the Power Indicator will turn solid blue.

Hold the On/Off Switch for 3 seconds. Wait until the blue light of the Power Indicator goes out, then remove your finger and DOBBY will switch off.

Aircraft Status Indicator

On the tail of the aircraft, there's an RGB indicator that shows the status of DOBBY. The Aircraft Status Indicator's status and the corresponding meanings are as follows:

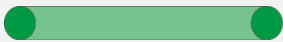
Indicator	Colour	Meaning
Normal Status		
	Solid Blue	GPS Positioning
	Slow Blue Flashing	Optic Flow and Ultrasonic Positioning
Warning and Abnormal Status		
	Fast Green Flashing	GPS Failure
	Fast Yellow and Green Flashing	Ultrasonic Failure
	Fast Yellow and Red Flashing	Optic Flow Failure
	Slow Yellow Flashing	No-Fly Zone Warning
	Fast Red Flashing	Low Battery Warning

	Solid Red	Critical Battery Warning
	Fast Purple Flashing	Compass Failure
Assistant Prompts		
	Solid Green	Horizontal Compass Calibration
	Solid White	Vertical Compass Calibration

GPS Positioning

DOBBY uses a GPS&GLONASS dual-mode satellite positioning system. The satellite positioning system is GPS based, with GLONASS acting as a supplementary system.

During outdoor flight, DOBBY uses GPS positioning when the number of searched-out GPS satellites ≥ 8 .

Optic Flow and Ultrasonic Positioning

DOBBY will use the optic flow and ultrasonic positioning during indoor flight. If the GPS signal is weak (the number of searched-out GPS satellites < 8) during outdoor flight, the aircraft will automatically use optic flow and ultrasonic positioning for supplement.

The optic flow and ultrasonic positioning system combines dynamic image analysis to horizontally position the aircraft during flight and ultrasonic distance measurement to determine the distance from the ground. It positions the aircraft during indoor flight and assists the GPS positioning system during outdoor flight.

The optic flow and ultrasonic positioning module is located on the base of the aircraft. It consists of an optic flow camera and an ultrasonic sensor.

Usage Conditions and Restrictions

The optic flow and ultrasonic positioning system is used for indoor flight. It is also used for outdoor flight if the GPS signal is weak. The operating height range for this positioning system is 0.5-3m.

When using this positioning system, after the aircraft has taken off and ascended to 0.5m, it will determine if the requirements for using this system have been met. If they have not, it will initiate landing. If the requirements are not met for this system during flight, the aircraft will also initiate landing.

Requirements for the optic flow and ultrasonic positioning system: When using this system, the area underneath the aircraft needs to have a clear textured surface that is not too sparse or too dense. Users can put a textured carpet or cloth on the ground, table or any large, horizontal surface to provide the required textured surface.



The optic flow and ultrasonic positioning system may not work under these circumstances, please use with caution:

- ✧ Above highly reflective surfaces;
 - ✧ Above water or transparent objects;
 - ✧ Above people or moving objects;
 - ✧ In areas with rapidly changing/flashing lights;
 - ✧ Above very bright or very dark surfaces;
 - ✧ Above objects that easily absorb ultrasonic waves;
 - ✧ Above surfaces without clear textures or with too sparse or too dense textures;
 - ✧ During fast flight at low levels (0.5m or less), the optic flow and ultrasonic positioning system may not work.
-



- ✧ Ensure that the lens of the optic flow camera is clear.
 - ✧ Because the ultrasonic positioning system may be disturbed by ultrasonic waves emitted by other ultrasonic equipment, please do not use DOBBY near other ultrasonic equipment, including other drones.
 - ✧ The Ultrasonic Sensor will emit ultrasonic waves that are inaudible to humans but may make some animals nervous. Please do not use DOBBY close to animals.
-

Flight Record

DOBBY will begin to record flight data from the moment you turn it on. It will stop recording the data once the power source is turned off. The name of the file will be the time when the data was recorded.

When you use the fault report function in the app, the flight record will be automatically uploaded to the server, so as to help with fault diagnosis.

Propeller

DOBBY has 4 sets of 3-inch foldable Propellers. The propeller blades are already mounted; users only need to expand the Arms before flight. When you're done flying, fold the Arms and the blades into the base of the aircraft to prevent damaging them.

The blades have either "A" or "B" on the top to indicate in which direction they spin, as shown in the following figure:

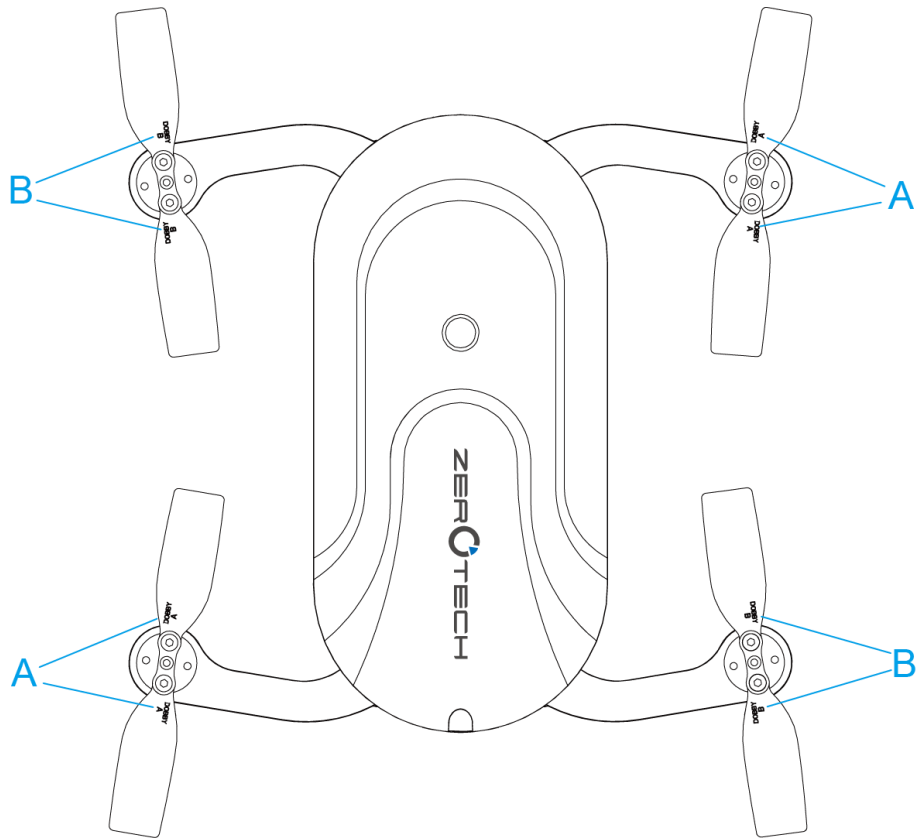

Replacing the Propeller Blades

Blades must be replaced with ones that spin in the same direction. Blades with an “A” on top must be replaced with ones that also have an “A”; Blades with a “B” on top must be replaced with ones that also have a “B”, as in the above figure.

How to replace the propeller blades:

Use a wrench or a screwdriver to loosen the screws, remove the old ones and mount the new ones onto the base, as shown in the following figure:

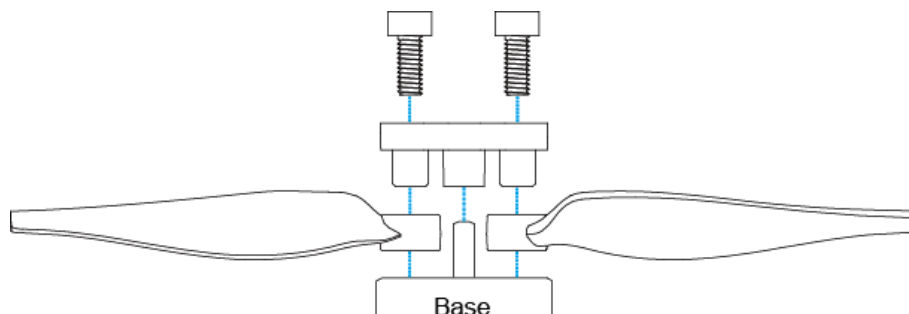

Please ensure that the propeller is tightly screwed in, to prevent against the screws coming loose and the propellers blades coming off during flight. It will need to be retightened after every 10 hours of flight.

Battery

The battery is designed specifically for use with DOBBY. It has a rated capacity of 970mAh and a nominal voltage of 7.6V.

The battery's major characteristics are as follows:

- Battery level display: The battery comes with a Battery Level Indicator, which shows the current battery level;
- Balance Charging Protection: automatic balance of the battery's internal cell voltage to preserve the battery;
- Overcharge Protection: Overcharging can seriously damage the battery. The battery will stop charging once it's charged to 8.7V;
- Over-discharge Protection: Over-discharging can seriously damage the battery. The battery will cease output once it's discharged to 4.6V;
- Short-circuit Protection: The battery will cease output to protect itself once short circuit occurs.

Before using DOBBY, ensure that the battery is fully charged. For more details about charging the battery, please refer to "Charging the Battery" on page 10.

Using the Battery

Please plug the battery into the battery compartment before using DOBBY.



- ✧ Please don't remove the batteries while the aircraft is turned on.
 - ✧ Battery overheating may affect the performance of DOBBY. Do not use it in hot environments (over 45°C). If the app notifies you of battery overheating, please immediately initiate landing, and suspend use before it's fully cooled down.
 - ✧ The battery may be very hot after use. Please do not touch it with bare hands immediately after use, for fear of burns.
 - ✧ If the battery leaks, emits an odor, generates heat by itself, changes shape (swells, etc.), changes color or shows any other abnormalities during use, charging or storage, please remove the battery immediately and cease use.
 - ✧ Do not use the battery in cold environments (under 5°C), or it may cause irreversible damage to it. When the temperature is low, the battery's usage time may drop. Please warm it up to 5°C or higher before plugging it into the aircraft, 20°C or higher is better.
-

Checking the Battery Level

The battery has a Battery Level Indicator and a Battery Level Button, set up as in the following figure:

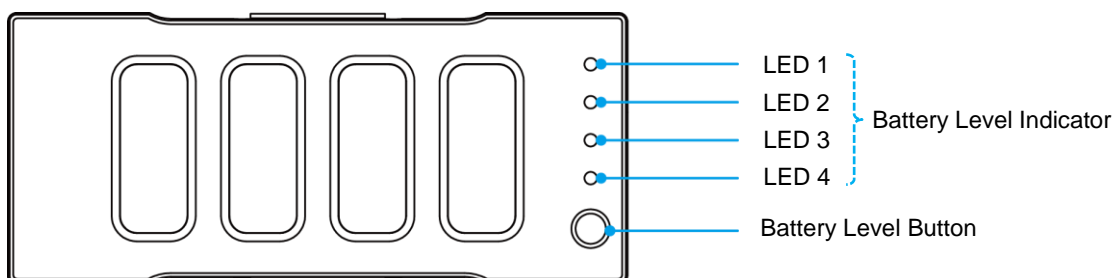

Press the Battery Level Button, and the Battery Level Indicator will show the current battery level. The indicator will go out automatically after 5 seconds. The indicator's status and the corresponding battery level in percentage are as follows:

	0~25%
	25%~50%
	50%~75%
	75%~100%

Charging the Battery

The battery comes with a charger, an adapter, and a USB cable.

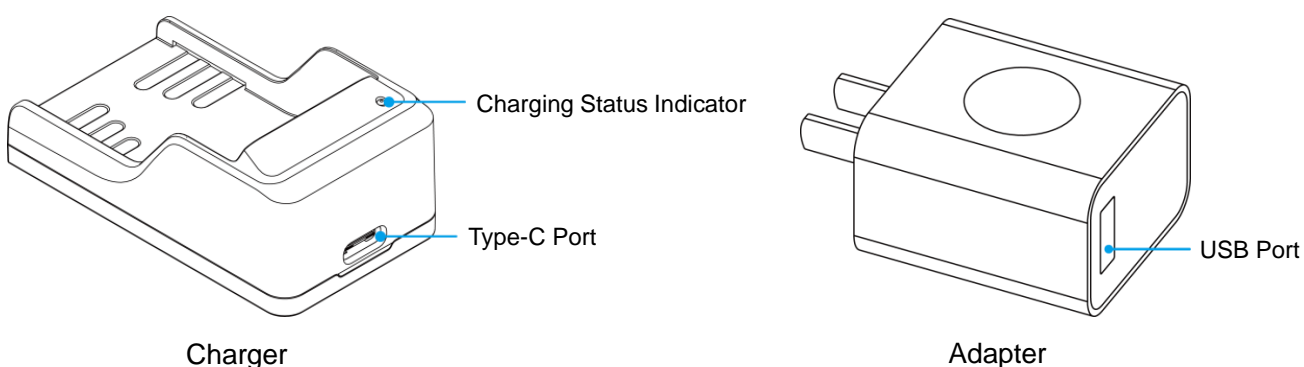

Plug the battery down into the charger. Use the USB cable to connect the charger to the adapter. Plug the adapter into a power socket to begin charging.

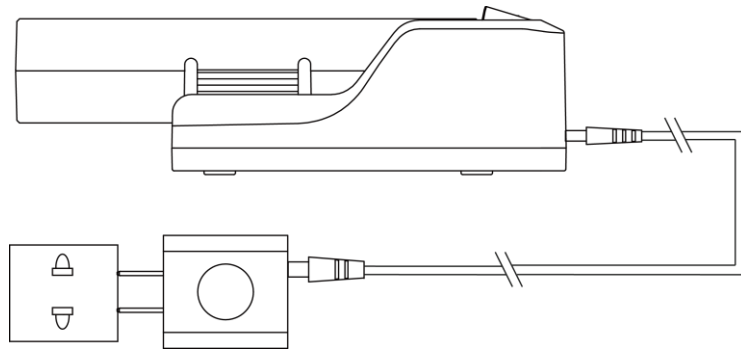

The charger uses quick charge technology. Using it together with the accompanying adapter allows for quick charge. The Charging Status Indicator will be solid orange during quick charge. If you don't use the provided adapter, it may only achieve slow charge instead of quick charge. The Charging Status Indicator will be solid red during slow charge.

If the Charging Status Indicator turns solid green, this means the battery is fully charged. Please turn off the power source and remove the battery from the charger.

The Charging Status Indicator's status and the corresponding meanings are as follows:

Indicator	Color	Meaning
	Solid Orange	Fast Charging
	Solid Red	Slow Charging
	Solid Green	Charging Completed
	Green Flashing	Not Charging
	Red Flashing	Failure



- ✧ We suggest you use the provided ZEROTECH's DOBBY battery charging devices to charge the battery. Any issues that occur due to use of other charging equipment shall be the responsibility of the user.
- ✧ Do not connect power sources or power banks to the Micro-USB port on the base of the aircraft. This may not only be unable to charge the battery effectively, but also damage the aircraft.



- ✧ Users can use a power bank to charge the battery. Plug the battery down into the charger, and use the USB cable to connect the charger to the power bank to begin charging.
- ✧ The adapter can only be used below 2000m above sea level.

Camera

DOBBY is equipped with a high definition camera that can take 4208x3120 photos and shoot 1920x1080 videos.

Camera's Pitch Angle

There are 6 rotations in the Camera's pitch angle limit. The lens facing the front: 0°; Push up the lens: elevation 22.5°; Push down the lens: successively depressions -22.5°, -45°, -67.5°, -90°.

The pitch angle can only be adjusted manually before flight. There are several ink lines on the side of the Camera corresponding to different pitch angles. Push the Camera to the needed angle, just exposing the corresponding ink line.

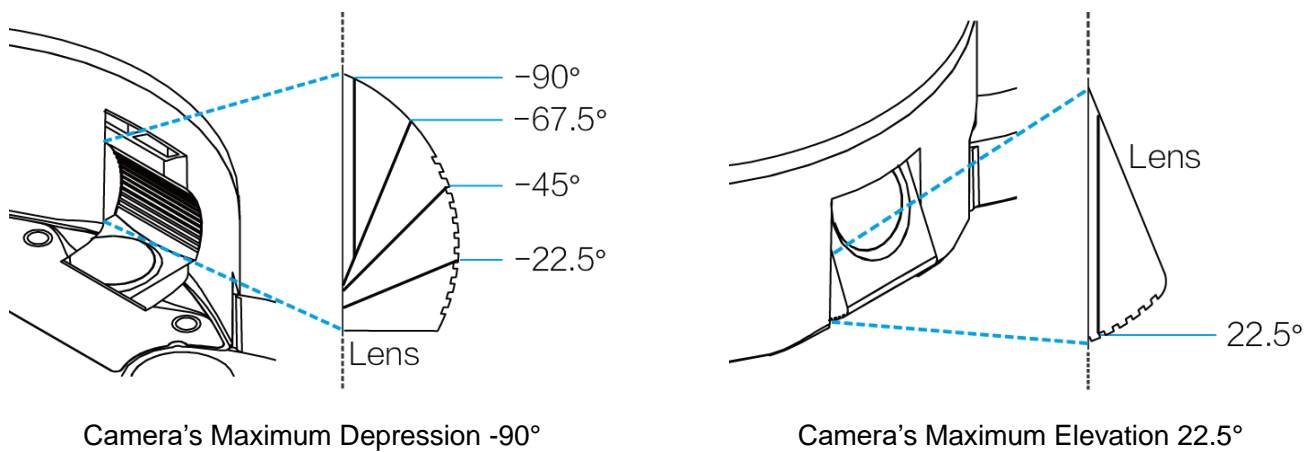

Micro-USB Port

While DOBBY is turned on, use the provided USB cable and adapter to connect DOBBY to your computer. You can then copy your photos and videos onto your computer.



- ◇ DOBBY must be turned on to be able to connect to your computer.
- ◇ DOBBY's Micro-USB port can only be connected to data communication ports, do not connect it to power sources or power banks.

Reset Button

Hold down the Reset Button on the base of the aircraft for 3 seconds until the Aircraft Status Indicator flashes blue, so as to reset the Wi-Fi, including:

1. The default SSID and password:

SSID: Dobby-XXXXXX. Labelled beside the battery compartment on the base of the aircraft, the “XXXXXX” are the last 6 alphanumeric digits of the Wi-Fi’s MAC address.

Password: zerotech.

2. The Wi-Fi frequency, which will reset to 2.4GHz.

App

This section will cover the main parts of the Do.Fun app and the settings.

App Profile

The Do.Fun app is specifically developed to be used with DOBBY. Users can use Do.Fun as a remote controller for flight control and photo & video shooting. You can also directly share your photos and videos to social networks.

The newly added “Discover” collects works by DOBBY all over the world; you can share your ones, too. “Mine” contains academy, bookmark, forum, etc.

Tap the little DOBBY icon at the bottom to enter the main interface.

App Main Interface

All the necessary status indicators and main function buttons are on the main interface. The layout is as follows:

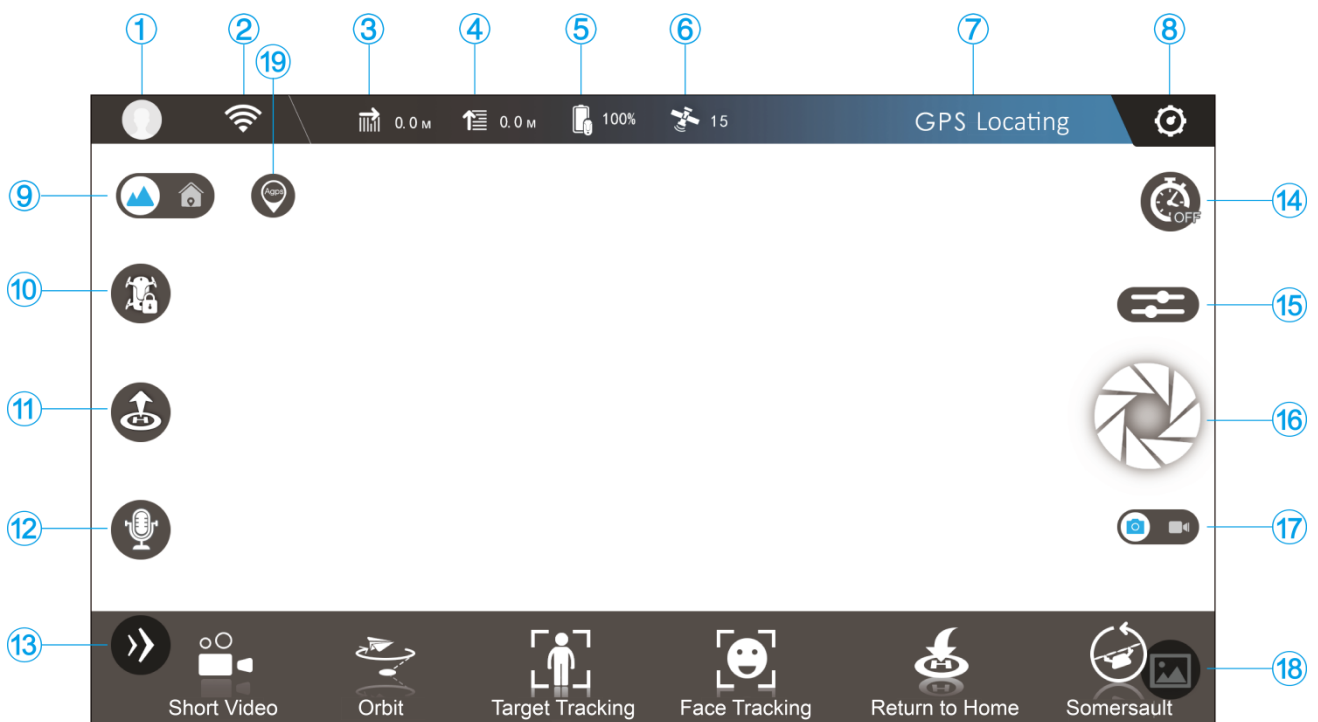

1. Login/Register

2. Wi-Fi Connection Status

3. Current Flight Distance

4. Current Flight Height

5. Aircraft Battery

6. Positioning Status

- | | | |
|--------------------------|--------------------------|--------------------------|
| 7. Status Bar | 8. App Settings | 9. Indoor/Outdoor Switch |
| 10. Emergency Shutdown | 11. Takeoff/Landing/Stop | 12. Voice control |
| 13. More Features | 14. Photo Timer | 15. Camera Settings |
| 16. Shutter | 17. Photo/Video Switch | 18. Media library |
| 19. A-GPS (Assisted GPS) | | |

Here's a brief description of these status indicators and function buttons. For more details on flight control and camera operation, please refer to "Flight/Shooting" on page 23.

1. Login/Register



Tap to login or register your ZEROTECH account.

Login/register will need to access the Internet by using mobile data or switching to router Wi-Fi.

2. Wi-Fi Connection Status



Wi-Fi connected



Wi-Fi disconnected



If the Wi-Fi connection is lost during flight, DOBBY will return and land if the GPS positioning is being used, or initiate landing if the optic flow and ultrasonic positioning is being used.

3. Current Flight Distance



The current flight distance will be displayed after the icon.

4. Current Flight Height



The current flight height will be displayed after the icon.

5. Aircraft Battery



Full battery (The battery level will be displayed in percentage after the icon)



Low battery (The battery level will be displayed in percentage after the icon)



Once the battery level gets too low during flight, DOBBY will initiate landing.



- ✧ A fully charged battery will allow for approximately 9 minutes of flight time.
 - ✧ Please schedule your shooting progress according to the current battery level, and charge the battery timely.
-

6. Positioning Status



GPS positioning status normal (The number of searched-out satellites will be displayed after the icon. The number ≥ 8 means normal)



GPS positioning status normal (The number of searched-out satellites will be displayed after the icon. The number < 8 means abnormal)



Optic flow and ultrasonic positioning status normal



Optic flow and ultrasonic positioning status abnormal



If the positioning status gets abnormal during flight, DOBBY will start to hover until the positioning status returns to normal or user lands it.

7. Status Bar

The status bar will display the current status information. Different levels of status will be displayed in different colors: red - abnormal status, yellow - status warning, blue - normal status. Abnormal status will be displayed by priority if there're several pieces of status information. Tap to see all the status information.

8. App Settings



Tap to enter the app settings and see 'About'.

Some of the settings will need to access the Internet by using mobile data or switching to router Wi-Fi.

9. Indoor/Outdoor Switch



Before takeoff, toggle to choose the current environment to be indoor or outdoor.

10. Emergency Shutdown



In case of emergency, drag this icon down to the designated position. The motor will immediately

shut down, and DOBBY will fall down.

11. Takeoff/Landing/Stop



Tap to initiate takeoff, or activate palm takeoff.



Tap to initiate landing, or enable palm landing.



Tap to stop during takeoff/landing.

12. Voice control



Hold to enable voice control.

13. More Features



Tap to pop up more features:



Short Video: DOBBY will automatically fly in the direction of the set lens angle, and record video.



Orbit: DOBBY will automatically fly around the chosen target, and record video.



Target Tracking: DOBBY will automatically follow the chosen target, and record video.



Face Tracking: DOBBY will automatically follow the chosen face t, and record video.



Return to Home: DOBBY will automatically return to the takeoff point and land.



Somersault: DOBBY will do a somersault.

14. Photo Timer



Tap to set whether to enable the photo timer or not and select the countdown.

15. Camera Settings



Tap to enter the camera settings:

Modes



Single shot: Tap to enter the single shot mode.



Burst shot: Tap to enter the burst shot mode and select how many photos to take.

Parameters

AWB: Tap to set the white balance.

EV: Tap to select the exposure value.

Preview Resolution: Tap to select the real-time preview resolution of the viewfinder frame.

Settings EIS: Tap to select the lens angle in the short video shooting and enable the EIS function.

16. Shutter



Tap to take photo(s).

17. Photo/Video Switch



Toggle to switch between the main interface and the conventional video recording interface.

18. Media library



Tap to enter your media library.

19. A-GPS (Assisted GPS)



indicates the A-GPS information file is valid. Use A-GPS can help with quick positioning.



indicates the A-GPS information file is expired and needs to be downloaded again (mobile data may be used).

App Settings

Photograph Vibration

It's turned off by default.

When it is activated, your mobile device will vibrate after taking photos.

App Mute

It's turned off by default.

When it is activated, your mobile device will be mute when the app is used.

Camera Orientation

It's set to "Selfie" by default.

We suggest you set it to "Selfie" when taking selfies. The Camera's perspective is opposite to the user's perspective. DOBBY's flight direction will follow the user's perspective. The flight direction will be the same as the operating direction for the user. Please refer to "Motion Sensing Method" on page 27, "Free Sticks Method" on page 30, "Safe Sticks Method" on page 32.

When you are not taking selfies, we suggest you set it to “Find a View” to switch back to the Camera’s perspective for easier operation.

This option only works with the motion sensing method and the two sticks methods, not with the swipe screen method. The swipe screen method always follows the camera’s perspective.

Control Method

It’s set to “Motion Sensing” by default.

Do.Fun comes with 4 control methods that users can choose between: “Motion Sensing”, “Swipe Screen”, “Free Sticks” and “Safe Sticks”.

The motion sensing method uses your mobile device’s gravity sensor. It allows you to control DOBBY’s flight by tilting your mobile device. For specifics on operation, please refer to “Motion Sensing Method” on page 27.

Looking through the camera’s perspective, the swipe screen method allows you to control DOBBY’s flight by swiping the screen in the viewfinder frame. For specifics on operation, please refer to “Swipe Screen Method” on page 29.

Just like the remote controller, the free sticks method allows you to control DOBBY’s flight by holding the virtual sticks and toggling up/down/left/right. For specifics on operation, please refer to “Free Sticks Method” on page 30. You can choose between “American Operator” (left-hand throttle) and “Japanese Operator” (right-hand throttle).

Just like the remote controller too, the safe sticks method allows you to control DOBBY’s flight by tapping on the arrows on the four directions in the virtual sticks. For specifics on operation, please refer to “Safe Sticks Method” on page 32. Also, you can choose between “American Operator” (left-hand throttle) and “Japanese Operator” (right-hand throttle).

Change Wi-Fi Information

You can change the Wi-Fi’s SSID and password. The SSID can be up to 16 characters long. It can be made up of Chinese, English, numbers and/or special characters. The password has to be between 8-20 characters long and can be made up of numbers, letters and/or special characters.

Frequency Switch

The default frequency is set to 2.4GHz.

DOBBY supports both a 2.4GHz and 5GHz frequency. You can switch between them on this page.

Language

Various languages for you to choose from.

Compass Calibration

Do.Fun can assist with compass calibration. Please refer to “Calibrating the Compass” on page 24.

Aircraft FC Update

Upgrade the aircraft flight control.

Aircraft OS Update

Upgrade the aircraft operating system.

Quick Guide

Download *DOBBY Quick Start Guide*, which may help you to learn to use.

Reset Guide Pages

Once again display the function guide pages, which may help you to learn the function of each button.

Capacity Available

Check the available storage space on DOBBY. Please schedule your shooting progress according to the available storage space and timely clear DOBBY’s memory.

About

App Upgrade, Fault Report, Feedback, etc.

Fault Report will help you deal with malfunction. Input your contact method, the SN

Media Library

When opening the media library, it will go to the photo gallery by default. Tap the “Video” button at the top of the screen to switch to the video gallery.

Photos

When you are connected to DOBBY’s Wi-Fi, after you take photos the thumbnails will automatically be sent to your mobile device. The photo gallery displays thumbnails in date order. Swipe up to load more thumbnails and swipe down to load new thumbnails.

If a photo is already downloaded to your mobile device, a mobile phone icon  will be added to the top

right hand corner of the thumbnail.

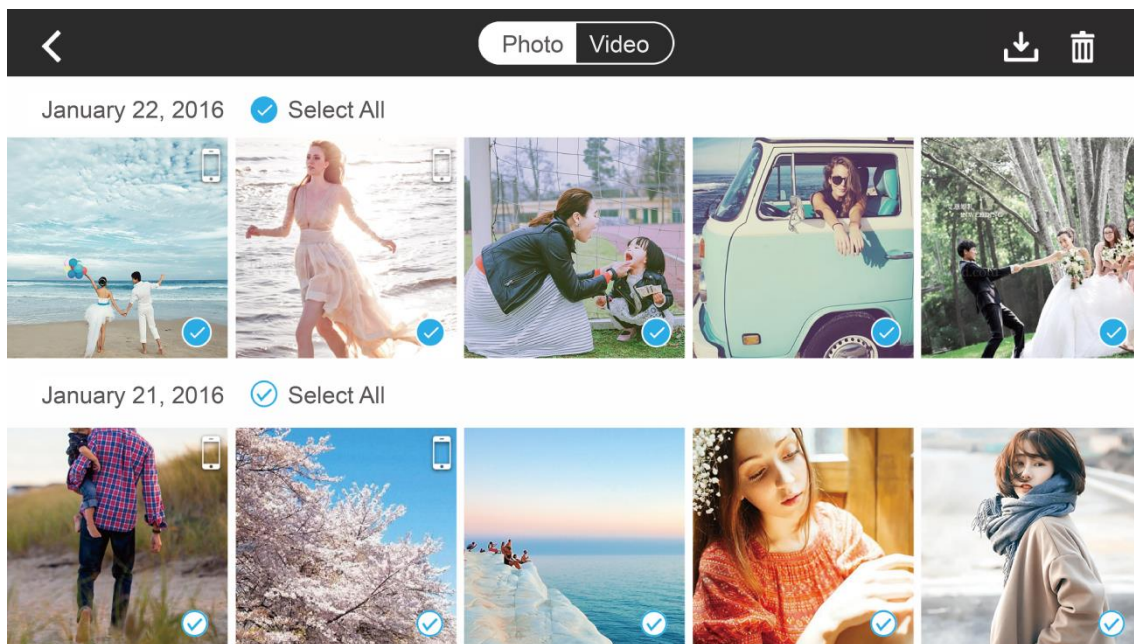

Selecting Photos

To select a photo, tap the tick in the bottom right hand corner of the photo. To select all the photos taken in one day, tap the “Select All” next to the date.

Deleting Photos

After selecting photos, tap the “Delete” button in the upper right hand corner of the screen to remove them from your media library. When you are connected to DOBBY’s Wi-Fi, it will delete the files from both DOBBY and your mobile device. When the Wi-Fi is not connected, it will not delete the files from DOBBY.

The browsing page also has a “Delete” button, so you can delete photos directly.



When an Android device is connected to DOBBY’s Wi-Fi, it will ask you to choose to delete from the mobile device or from DOBBY.

Downloading & Browsing

After selecting photos, tap the “Download” button in the upper right hand corner of the screen to download them to your mobile device. You can also download and browse a photo by tapping on the thumbnail. You can directly download and browse the previous/next photo by swiping left/right on the photo browsing page. Tapping on a photo will make it full screen.



If you have an iOS device, allow access to your gallery in system settings, otherwise you will only be able to tap the “Download” button in the top right hand corner to download photos to your gallery. Other downloading methods will download photos into a new folder and won’t be able to download photos into your gallery.

Photo Sharing

There is a “Share” button on the browsing page, tapping it will directly share your photos to your Facebook, WeChat and Weibo.



Sharing your photos will need to access the Internet by using mobile data or switching to router Wi-Fi.

Videos

Browsing through videos is basically the same as browsing through photos, but to download videos to your mobile device you need to tap the “Download” button on the top right hand corner after selecting them. There will be a progress bar during the download. You can download multiple videos at the same time. You can also background download.

There’s a “Share” button on both the video gallery page and the playing page. You can share your videos directly with your friends on WeChat, Weibo and Facebook.



iOS mobile device users, please allow access to your gallery in system settings, otherwise you will only be able to download videos into a new folder and not into your gallery.

Flying/Shooting

Before flying please read *Disclaimer* and *Battery Safety Instructions* to understand the safety precautions. This section will cover what you need to know and how you need to prepare before flying DOBBY, as well as details on flight and photo & video shooting operations.

Flight Environment Requirements



We suggest you conduct the first flight in an open outdoor area, and you can turn off the novice mode to conduct indoor flight after getting familiar with the flight control.

Outdoors

1. Don't fly DOBBY in bad weather conditions, such as in high wind, rain, snow.
2. When flying, always keep DOBBY in your line of sight. Ensure that you avoid obstacles, high voltage wires, trees and shrubbery, groups of people, bodies of water.
3. Please fly in open area, do not fly near buildings and keep a good distance from tall buildings, for fear that the GPS signal would be blocked.
4. Do not fly near complex electromagnetic environments, such as near signal tower, base station, for fear that the Wi-Fi signal would be interfered.
5. Do not fly near areas with abnormal magnetic fields, for fear that the compass would be interfered. DOBBY cannot fly in the north and south poles.
6. In areas 3000m or higher above sea level, the flight performance may be affected due to environmental conditions. Please use with caution.

If the GPS signal is weak, DOBBY will use the optic flow and ultrasonic positioning. Please fulfil the requirements for the optic flow and ultrasonic positioning, see “Indoors”.

Indoors

1. During indoor flight, DOBBY uses the optic flow and ultrasonic positioning. The flight area needs to be above a clear textured surface that is not too sparse or too dense. If you can't find an appropriate textured surface, you can put a textured carpet or cloth on the ground, table or any large, horizontal surface to provide the required texture.
2. Indoor flight needs to be conducted in a well-lit area (luminosity > 15lux) such as an area illuminated

by an ordinary fluorescent lamp.

3. During fast flight at low levels (0.5m or less), the optic flow and ultrasonic positioning system may not work.

For more requirements for indoor flight, please refer to “Optic Flow and Ultrasonic Positioning” on page 6.

Flight Restrictions

- ✧ Maximum ascent height under the GPS positioning: 50m.
- ✧ Maximum ascent height under the optic flow and ultrasonic positioning: 3m.
- ✧ Maximum control distance: 100m (in open air free of interference).

No-Fly Zone

Please do not fly in areas where flying is illegal or restricted.

According to regulations, the surrounding areas of airports are strictly no fly zones.

In no-fly zones, DOBBY will not be able to fly while using the GPS positioning. The Aircraft Status Indicator will be slow yellow flashing. The app will prompt the no-fly zone warning

Preflight Checklist

Please check the following items before flying. You can take off only if all of the items are OK:

1. Check that DOBBY and your mobile device have enough power;
2. Check that the Arms are fully expanded;
3. Check that the propeller blades and other parts of the aircraft aren't loose or damaged;
4. Check that the lenses on both the optic flow camera and the front facing camera are clean.

Calibrating the Compass

DOBBY relies on the compass to determine its heading.

The compass is easily interfered by other magnetic materials and electronic devices. This can lead to data inaccuracies, unsafe flight, even crash. And the on-site magnetic field condition also affects the accuracy of the compass. So, regular calibrations before flight help the compass to work at its best.



- ✧ You're required to calibrate your compass in the following cases!
 - Before the first flight, and before the first outdoor flight;
 - The location you are flying is quite far from the last location you flew;
 - The Aircraft Status Indicator is fast purple flashing, indicating compass failure;
 - The Aircraft drifts severely, for example: cannot fly straight.
 - ✧ Expand the arms before calibrating, so as to avoid interference.
 - ✧ Do not calibrate your compass near large metal objects or in places with strong magnetic field interferences.
 - ✧ Do not place DOBBY close to other magnetic materials and electronic devices (such as magnet, mobile phone, tablet PC and stereo equipment).
-

The process of compass calibration is as follows:

1. Expand the Arms. Turn on the aircraft. Connect to the aircraft's Wi-Fi. Enter Do.Fun's "Settings" - "Compass Calibration", and tap on "Start".

2. Keep the aircraft horizontal (the Aircraft Status Indicator will turn solid green if it's set to the required angle). Slowly rotate it 2-3 times. During this rotation, make sure the indicator stays solid green, or you will need to adjust the aircraft's angle once again. The app will automatically jump to the next step once it's done.



3. Keep the aircraft head vertical downwards (the Aircraft Status Indicator will turn solid white if it's set to the required angle). Slowly rotate it 2-3 times. During this rotation, make sure the indicator stays solid white, or you will need to adjust the aircraft's angle once again.

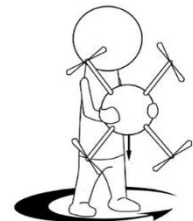

4. The app will notify you once calibration is completed. At this point the Aircraft Status Indicator will show the aircraft's actual status.



- ✧ After the horizontal calibration, immediately begin the vertical calibration, don't stop midway.
 - ✧ The calibration will take effective immediately (no need to restart the aircraft).
-

Flight Protection

In order to ensure safe use and to avoid damage, ZEROTECH has fitted DOBBY with multiple flight protection measures:



- ✧ If the battery level gets too low or a major failure occurs, DOBBY will immediately initiate landing.
- ✧ If both the GPS and the optic flow and ultrasonic positioning systems are not working, DOBBY will start to hover until the positioning status returns to normal or user lands it. But if the battery level gets too low while hovering, DOBBY will initiate landing.
- ✧ If the Wi-Fi connection is lost or the app drops out, DOBBY will return and land if the GPS positioning is being used, or initiate landing if the optic flow and ultrasonic positioning is being used.
- ✧ When the app is minimized or you get a phone call, DOBBY will start to hover until you are back to the app. But if the battery level gets too low while hovering, DOBBY will initiate landing.
- ✧ When DOBBY tilts beyond 45°, it will automatically stop the motor as a safety precaution (excluding during somersault).
- ✧ In case of emergency, you can use the emergency shutdown function to immediately stop the motor and fall down. Refer to Page 42 “Emergency Shutdown”.

Connecting the Aircraft to Do.Fun

Connect your mobile device to the aircraft’s Wi-Fi. The default SSID is like Dobby-XXXXXX. Check the label beside the battery compartment on the base of the aircraft to acquire your SSID. The default password is zerotech. And you can change them in “App Settings”.





Open the main interface of Do.Fun. First, toggle the “Indoor/Outdoor Switch” to choose your current environment:



indicates indoor, optic flow positioning will be used.



indicates outdoor, GPS positioning will be used.

At last, check if it shows that it’s connected to the Wi-Fi , that the aircraft’s battery level is high , and that the optic flow positioning status is normal  or the GPS positioning status is normal . If so, it’s ready to fly, and you can take off.



Please manually adjust the Camera's pitch angle depending on your need before flight. Refer to "Camera" on page 12.



- ✧ When flying, keep DOBBY in your line of sight. Please ensure you keep DOBBY a good distance away from people.
 - ✧ When you touch DOBBY with your hand or other objects, like when using the palm takeoff/landing function, take care not to touch the propeller.
 - ✧ Take extra care not to run into people or objects during indoor flight.
-

Takeoff/Landing



Takeoff

Ground Takeoff : Tap it, DOBBY will directly take off and ascend to 1.5 meters (1m for indoors).

Palm Takeoff: Please first place DOBBY on your palm/tray, and then tap the button, the propellers will start to rotate. Wait until they fully rotate, remove your palm/tray or slightly toss it.



Landing

Ground Landing: Tap it, it will start to descend and land onto the ground.

Palm Landing: Tap it, it will start to descend. During it descends to 2.2~1.1 meters above the ground (a progress bar will pop up on the screen), you can conduct palm landing. Stretch your palm/tray right under DOBBY, then it will land onto your palm/tray.

Flight Control



- ✧ During your first flight, please begin with operating on a small scale. Pay attention to the flight direction and adjust the flight speed, slowly working towards moderate-scale operation.
 - ✧ Please don't operate on too large scale, so as to avoid accidental collision.
-

Motion Sensing Method

Using your mobile device's gravity sensor system, you can control flight by tilting your mobile device.

The left hand half of the screen is the swipe zone which controls ascent/descent and direction; the right hand half is the motion zone which controls flying forward/backward/left/right, as in the picture below:

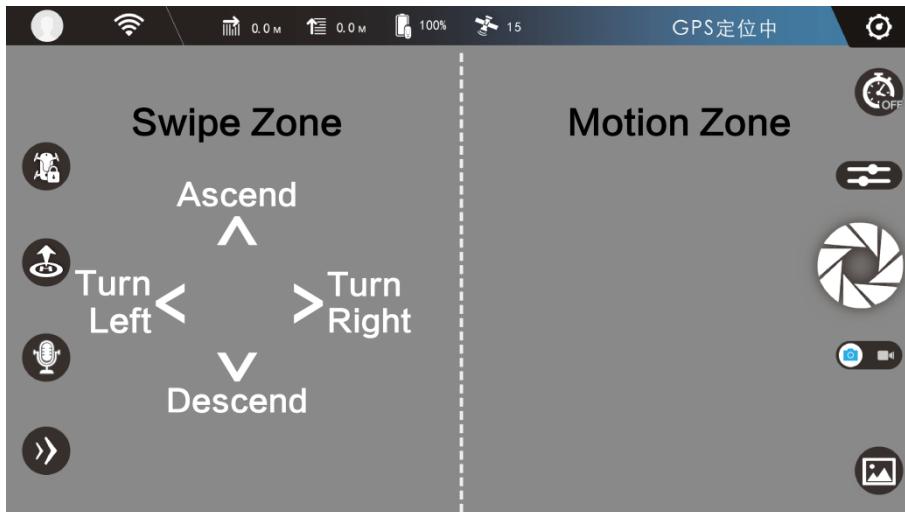

Fly forward/backward/left/right:

Your mobile device tilted within 45° from horizontal, hold down on any part of the right hand half (motion zone) of your screen, and tilt your mobile device forward/backward/left/right. For fear of misoperation, the motion sensing can be activated by holding down on the screen only when the mobile device's angle from horizontal is within 45°.

Ascent/descent:

Swipe the left hand half (swipe zone) of your screen up/down. Swipe and hold to continue the movement.

Turn left/right:

Swipe the left hand half (swipe zone) of your screen left/right. Swipe and hold to continue the movement.

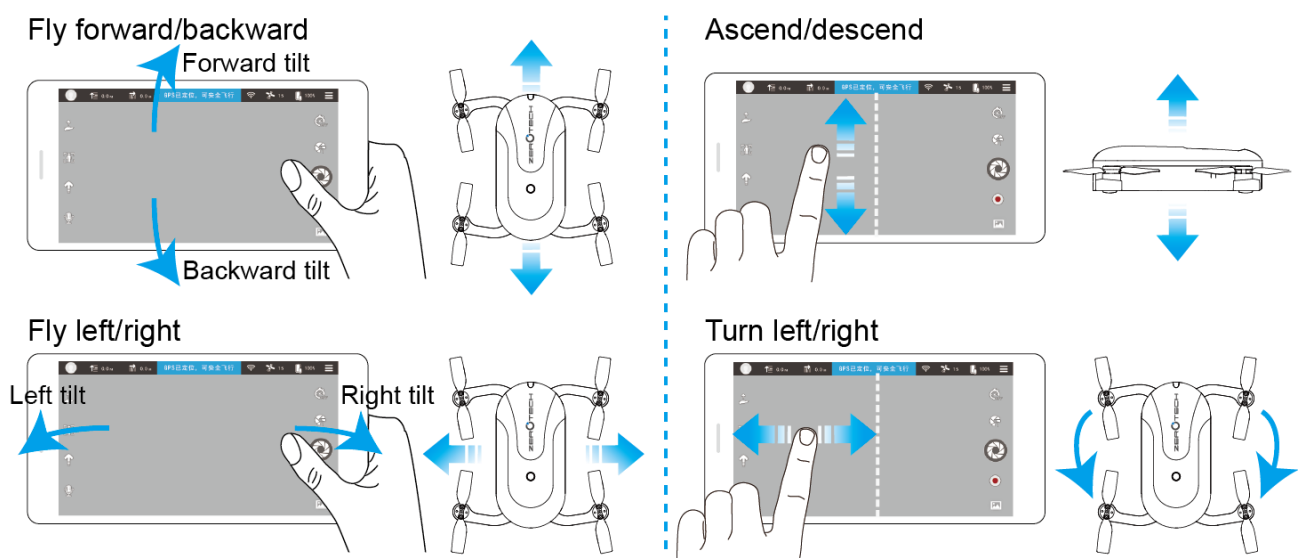

✧ App is set to "Selfie" by default. You can switch it to "Find a View" in "App Settings" -

“Camera Orientation”. Please refer to “Camera Orientation” on page 18 for its meaning and applicable usage.

- ✧ The default control method is set to “Motion Sensing”. If it’s already switched to other methods, you can switch it back to “Motion Sensing” in “App Settings” - “Control Method”.
-

Swipe Screen Method

Looking through the Camera’s perspective, you can control DOBBY’s flight by swiping the screen in the viewfinder frame.

Ascent/descent, fly left/right:

Swipe the screen up/down, left/right. Swipe and hold to continue the movement.



Fly backward:

Two fingers swipe the screen and get close to each other. Swipe and hold to continue the movement.

Fly forward:

Two fingers swipe the screen and get away from each other. Swipe and hold to continue the movement.

Turn left/right:

Tap the  direction icon in the top right hand corner, it changes into . And then swipe the screen left/right. Swipe and hold to continue the movement. Tapping  again will exit direction control.

Ascend/descend

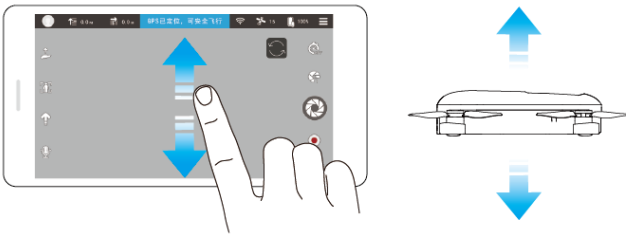

Fly backward

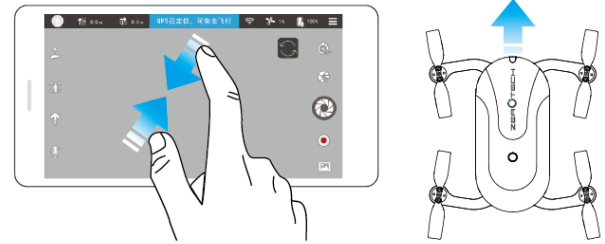

Fly left/right

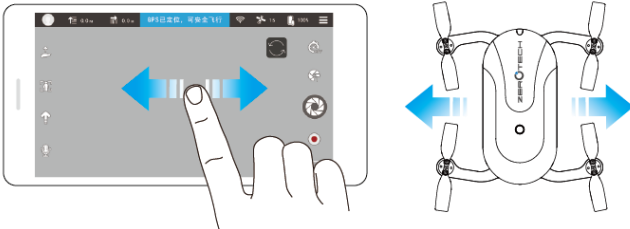

Fly forward

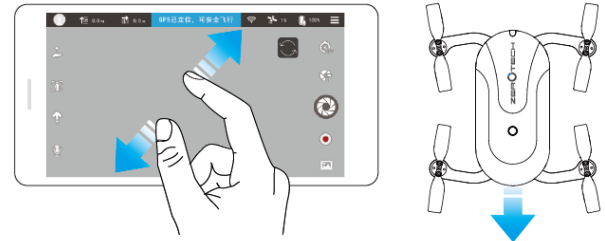

Turn left/right

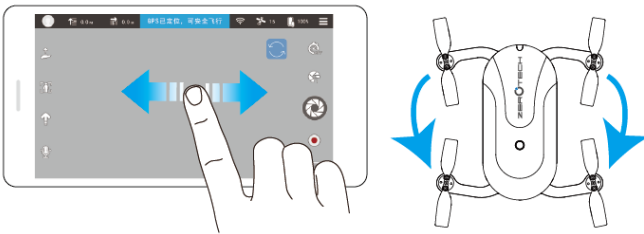

- ✧ The default control method is set to “Motion Sensing”. You can switch it to “Swipe Screen” in “App Settings” - “Control Method”.
- ✧ All the directions means the own directions of the aircraft.

Free Sticks Method

Just like the remote controller, the free sticks method allows you to control DOBBY’s flight by holding the virtual sticks and toggling up/down/left/right.

Take the American Operator mode for example: The left stick controls ascent/descent and direction (left-hand throttle); the right stick controls flying forward/backward/left/right, as in the picture below:

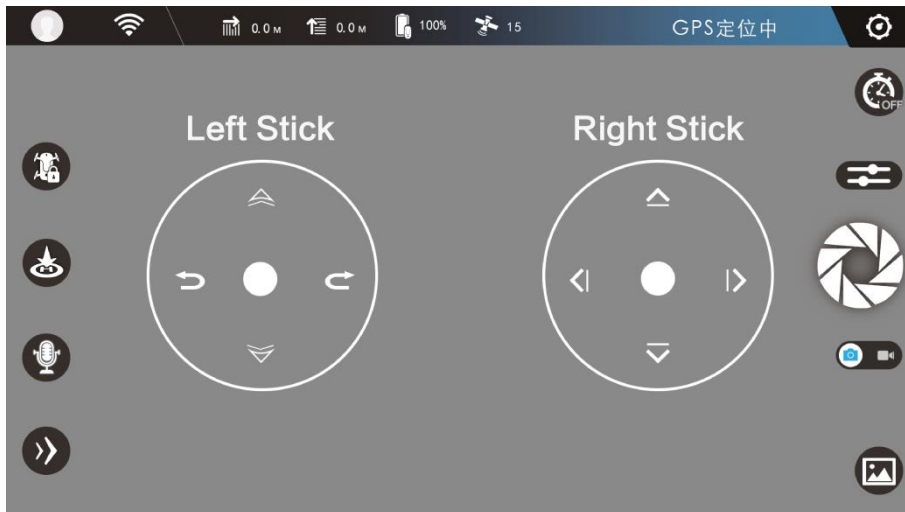

Ascent/descent:

Hold down on the left stick (the dot at the center of the left circle) and toggle up and down. Toggle and hold to continue the movement.

Turn left/right:

Hold down on the left stick (the dot at the center of the left circle) and toggle left and right. Toggle and hold to continue the movement.

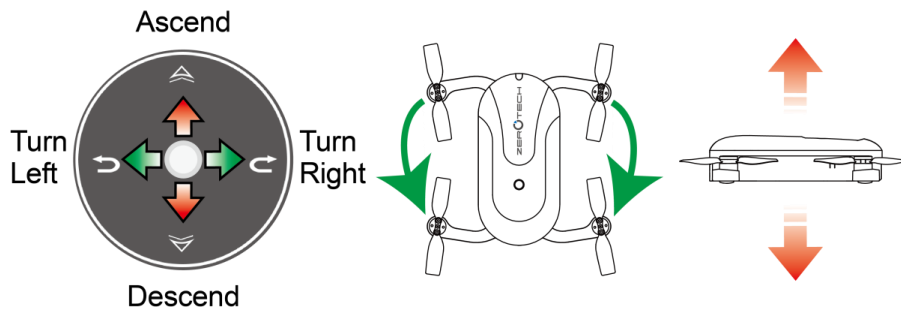

Fly forward/backward/left/right:

Hold down on the right stick (the dot at the center of the right circle) and toggle up/down/left/right. Toggle and hold to continue the movement.

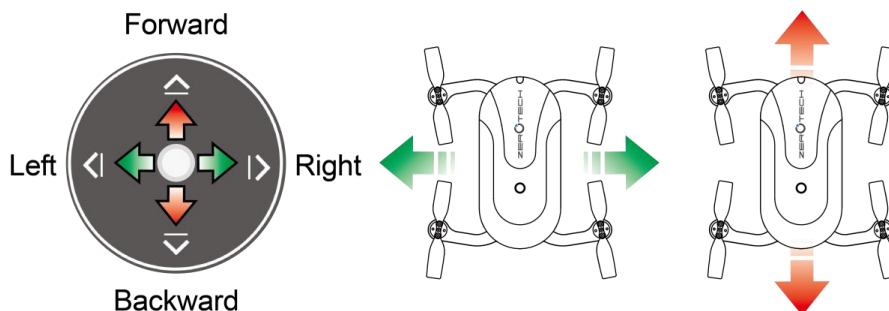



- ✧ Actually, you don't have to stick to the position of the sticks drawn on the screen. Hold down on any part of the left side of the screen, and the left stick will follow to the point where you hold down; so it is for the right stick.
 - ✧ The default control method is set to "Motion Sensing". You can switch it to "Free sticks" in "App Settings" - "Control Method".
 - ✧ After choosing "Free sticks", you can choose between "American Operator" (left-hand throttle) and "Japanese Operator" (right-hand throttle).
 - ✧ App is set to "Selfie" by default. You can switch it to "Find a View" in "App Settings" - "Camera Orientation". Please refer to "Camera Orientation" on page 18 for its meaning and applicable usage.
-

Safe Sticks Method

Just like the remote controller too, the safe sticks method allows you to control DOBBY's flight by tapping on the arrows on the four directions in the virtual sticks.

The operations of the safe sticks method are similar to the free sticks method. However, it uses tapping on the arrows on the four directions instead of toggling. For the details, please refer to "Free Sticks Method" on page 30.



- ✧ Different from the free sticks, the positions of safe sticks are fixed.
 - ✧ The default control method is set to "Motion Sensing". You can switch it to "Safe sticks" in "App Settings" - "Control Method".
 - ✧ After choosing "Safe sticks", you can choose between "American Operator" (left-hand throttle) and "Japanese Operator" (right-hand throttle).
 - ✧ App is set to "Selfie" by default. You can switch it to "Find a View" in "App Settings" - "Camera Orientation". Please refer to "Camera Orientation" on page 18 for its meaning and applicable usage.
-

Taking Photos/Video Recording

Taking Photos



Single shot: In the single shot mode, every time you tap the  "Shutter" button, it will take one photo.

Burst shot: In the burst shot mode, every time you tap the  "Shutter" button, it will take a series of burst shot photos.

You can take photos using the volume buttons on your mobile device or earphones. It is the same method

as using the  "Shutter" button.



- ✧ The default mode is set to single shot. You can tap the  "Camera Settings" button to switch between the single shot mode and the burst shot mode, and select how many photos to take (3 photos by default) in the "Modes" menu. Please refer to "Camera Settings" on page 17.
- ✧ The photo timer is closed by default. You can tap the  "Photo Timer" button to activate the photo timer and select the countdown. Please refer to "Photo Timer" on page 17.



EIS

EIS (Electronic Image Stabilization) can deblur the images of a video, eliminating jitter, jelly, etc. It applies to both the conventional video recording and the 10s auto-track short video recording. We suggest you enable it.

How to enable EIS: Tap the  "Camera Settings" button, and select any of the lens angles in "Settings" - "EIS". Please refer to "Camera Settings" on page 17. EIS needs to be enabled once again each time you open the app.

How to disable EIS: When the temperature of the aircraft reaches 70°C or you quit the app, EIS will automatically be disabled. Also, you can close EIS in "Camera Settings" - "Settings" - "EIS".

Conventional Video Recording

1. Tap the  "Photo/Video Switch" to go to the conventional video recording interface.
2. The conventional video recording interface is as follows. Tap the  "Record" button to start recording. Tap the  "Stop Recording" button on the right hand side of the interface to end your recording. Conventional video recording can last as long as you want. The duration will be displayed at the bottom of the interface.



During the conventional video recording, you can use the motion sensing method, the swipe screen method, the free sticks method or the safe sticks method to control the flight.

“More Features”

This section will introduce how to use “Short Video”, “Target Tracking”, “Somersault” and other features in “More Features” .

Short Video (Only under Outdoor GPS Positioning)



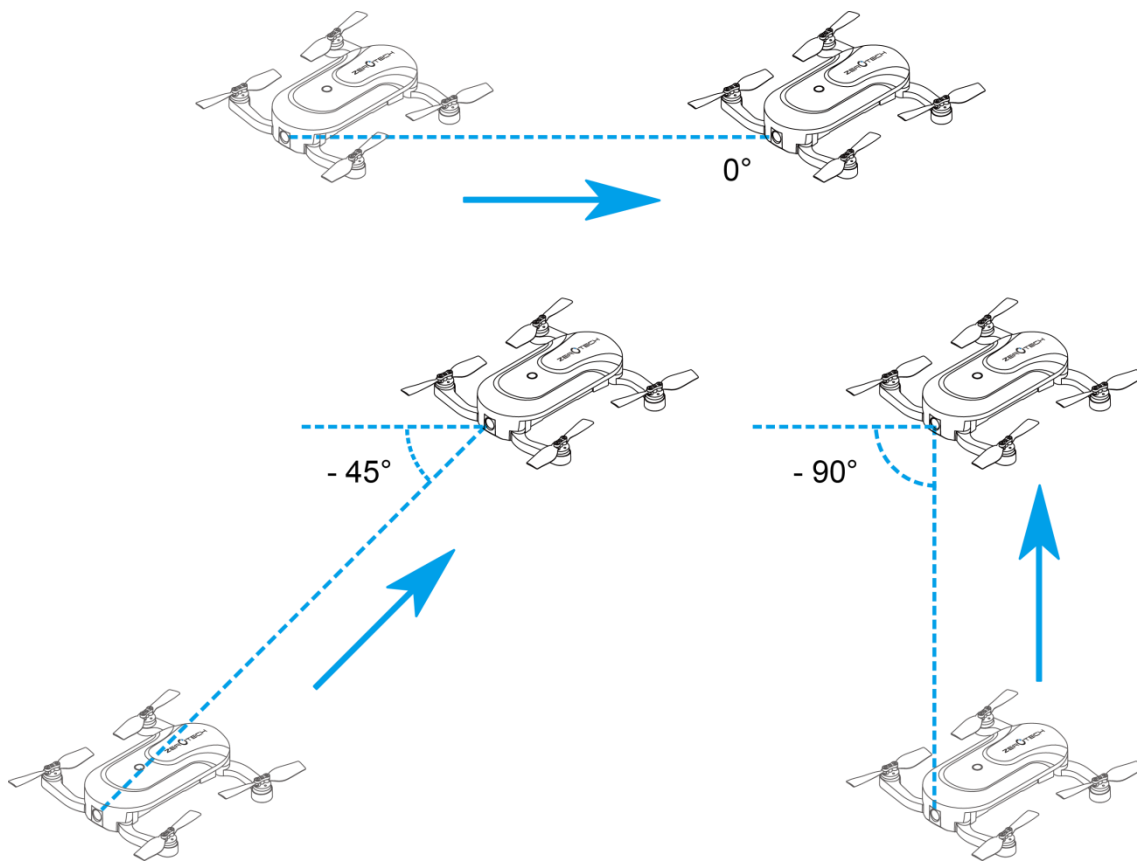

Short video enables the aircraft to automatically fly backwards and upwards in a certain angle and simultaneously record video, or to record video during the return flight.

The selectable lens angles are 0° 、 -22.5° 、 -45° 、 -67.5° or -90° . Here we respectively take the selected lens angles 0° 、 -45° and -90° for example to illustrate the relationship between the flight path in the short video recording and the lens angle:



To use the target tracking feature, we suggest you manually adjust the Camera's pitch angle to the lens angle you wish to select before flight.

How to use it:

1. Tap the  "Camera Settings" button, and select the needed lens angle (also enable EIS) in "Settings" - "EIS".
2. Tap the  "More Features" button on the bottom left corner of the main interface, and select  "Short Video" in the popup features list to go to the short video recording interface.
3. The short video recording interface is as follows. Hold the  "Record" button on the right hand side of the interface to record video. Meanwhile, DOBBY will fly in the direction of the selected lens angle. Short video recording can last 10 seconds. The duration will be displayed at the bottom of the interface. Releasing your finger off the button (or the duration reaching 10s) will stop recording, and DOBBY will automatically return. You can also record short videos by holding  during DOBBY's return flight.



- ✧ The short video feature can be used only under outdoor GPS positioning.
- ✧ We suggest you adjust the Camera's pitch angle to the lens angle you wish to select. It can be manually adjusted before flight, refer to "Camera" on page 12.
- ✧ Please be careful not to collide with other objects during recording short video. Release your finger off the button to return if necessary.

Orbit (Only under Outdoor GPS Positioning)

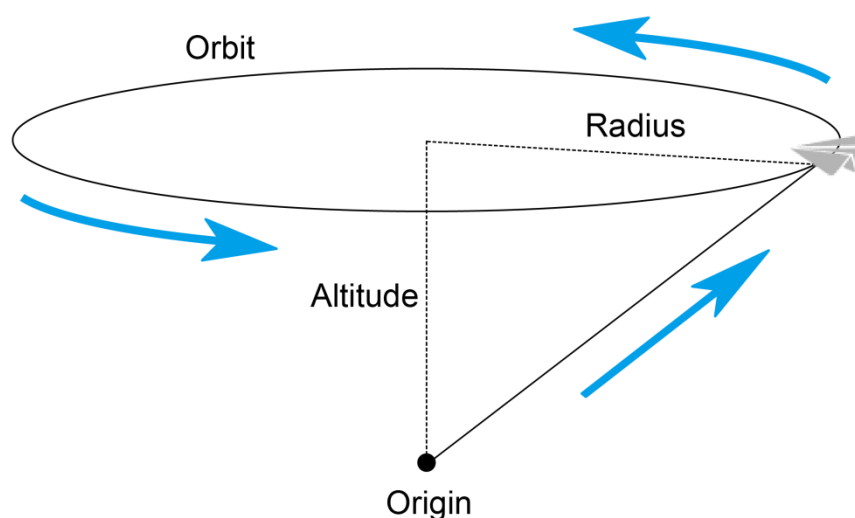

Orbit enables the aircraft to automatically fly and record video around a certain point (the origin) with a certain radius and at a certain altitude.

When using it, first, you set the radius and the altitude to determine the orbit. Then, the aircraft flies backwards and upwards from the origin to the orbit. Finally, you control it to fly along the orbit counterclockwise or clockwise. Shown as follows (taking counterclockwise for example):



To use the orbit feature, you need to adjust the Camera's pitch angle to 22.5° before flight.

How to use it:

1. Fly DOBBY to any position (the origin). Then tap the  “More Features” button on the bottom left corner of the main interface, and select  “Orbit” in the popup features list
2. In the settings interface, drag the drone icon to the blue area to set the altitude and the radius of the orbit. The horizontal axis shows the radius, and the vertical axis shows the altitude. Please make sure that there is no obstacle near the orbit.

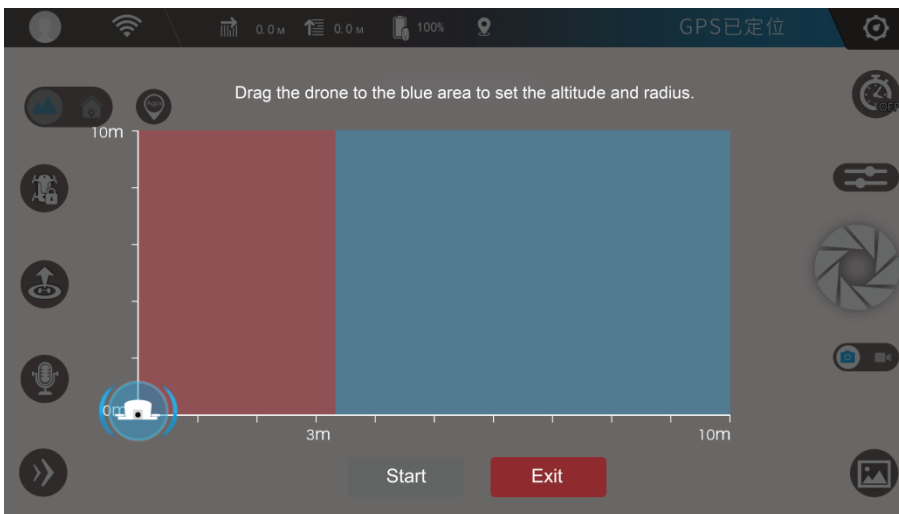

The aircraft will fly to the position where you drag it to. The radius and the altitude will be displayed on the screen as follows. After you've set the radius and the altitude, tap the “Start” button to go to the control interface.

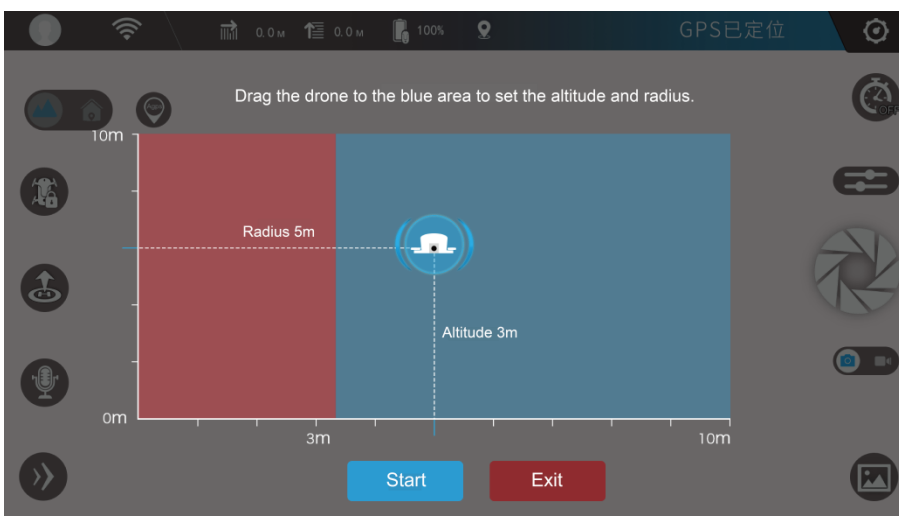

3. In the control interface, the two round buttons respectively represent counterclockwise orbiting and

clockwise orbiting, as shown below. Hold the left button, and the aircraft will fly and record video around the origin counterclockwise with the set radius and at the set altitude; Hold the right button, and the aircraft will fly and record video around the origin clockwise. Releasing your finger off the button will stop recording. The duration will be displayed at the top of the interface.





- ✧ The short video feature can be used only under outdoor GPS positioning.
- ✧ The Camera's pitch angle must be adjusted to 22.5° first. It can be manually adjusted before flight, refer to "Camera" on page 12.
- ✧ Please be careful not to collide with other objects during orbiting. Release your finger off the button to stop if necessary.

Target Tracking (Only under Outdoor GPS Positioning)

Target tracking enables the aircraft to automatically follow and record video on the moving target you've chosen.

To use the target tracking feature, you need to adjust the Camera's pitch angle to - 45° before flight.

How to use it:

1. Fly DOBBY to over 5 meters above the ground. Then tap the  "More Features" button on the bottom left hand corner of the main interface, and select  "Target Tracking" in the popup features list.
2. Draw a frame on the screen to select the target to follow. A red frame will show up. Cover the target with the red frame.

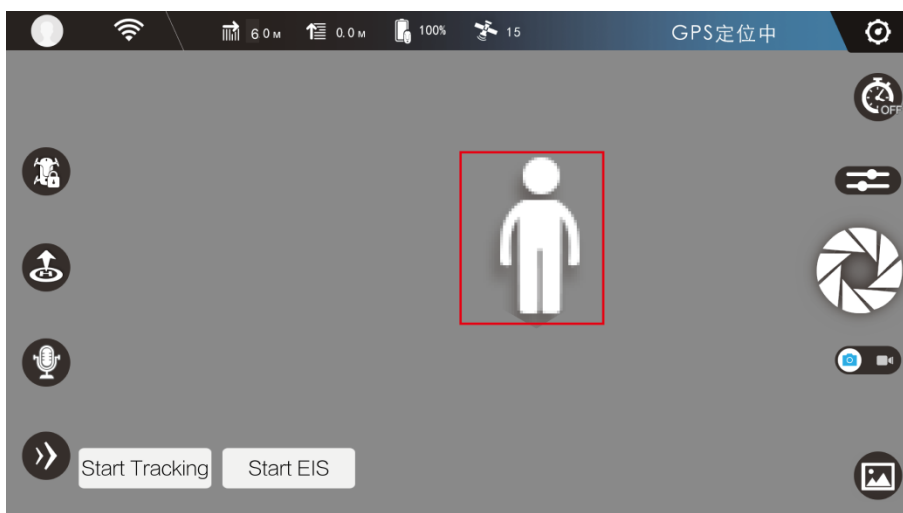

3. Tap the “Start Tracking” button in the bottom left hand corner of the screen. The red frame will turn green, indicating the target tracking is started. When the target moves, DOBBY will follow it. Tap the “Start EIS” button to start to record during target tracking. Tapping the “Stop EIS” button will stop recording.



4. After you’ve finished the target tracking, tapping the “Stop Tracking” button will quit it.





- ✧ The target tracking feature can be used only under outdoor GPS positioning.
- ✧ The Camera’s pitch angle must be adjusted to - 45° first. It can be manually adjusted before flight, refer to “Camera” on page 12.
- ✧ If the illumination changes drastically, or the target moves too fast, makes a sudden turn or overlaps with a similar object, DOBBY may lose the target.
- ✧ Please be careful not to collide with other objects during target tracking. Tap the “Stop Tracking” button if necessary.

Face Tracking

Face tracking enables the aircraft to automatically follow and record video on the moving face you've chosen.

To use the face tracking feature, you need to adjust the Camera's pitch angle to 0° before flight.

How to use it:

1. Fly DOBBY to an appropriate height. Then tap the  "More Features" button on the bottom left hand corner of the main interface, and select  "Face Tracking" in the popup features list.
2. If there's only one face on the screen, that face will be automatically recognized. If there're several faces on the screen, you need to tap on the face to follow. A red frame will show up and cover the face.



3. Tap the "Start Tracking" button in the bottom left hand corner of the screen. The red frame will turn green, indicating both the face tracking and the video recording is started. When the face moves, DOBBY will follow it.

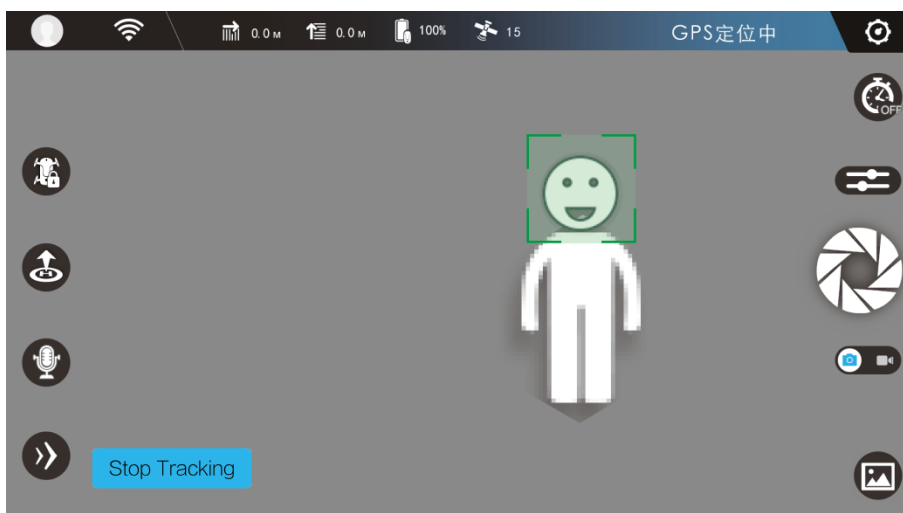



4. After you've finished the face tracking, tapping the "Stop Tracking" button will quit it and stop the video recording.



- ✧ The face tracking feature can be used in both indoors and outdoors.
- ✧ The Camera's pitch angle must be adjusted to 0° first. It can be manually adjusted before flight, refer to "Camera" on page 12.
- ✧ If the illumination changes drastically, or the face moves too fast, makes a sudden turn or overlaps with a similar object, DOBBY may lose the face.
- ✧ Please be careful not to collide with other objects during face tracking. Tap the "Stop Tracking" button if necessary.

Return to Home (Only under Outdoor GPS Positioning)

Return to Home enables the aircraft to automatically return to the takeoff point and land.

How to use it: Tap the  "More Features" button on the bottom left hand corner of the main interface, and select  "Return to Home" in the popup features list.



- ✧ If there're trees, utility poles, highline or other obstacles on the way of the return, DOBBY may collide with it. Please confirm that there're no obstacles between the current position of DOBBY and the takeoff point.
- ✧ If it is about to collide, please tap the  "Stop" button, or immediately control it to avoid the obstacle manually.



- ✧ The return to home feature can be used only under outdoor GPS positioning.
- ✧ You can tap the  "Stop" button to stop for other operations on the way of the return.

Somersault

Coming soon.

Voice Control

Hold the  “Voice Control” button on the left hand side of the main interface. A microphone icon will pop up in the middle of your screen. You can control DOBBY’s actions by speaking corresponding commands to your mobile device.

Command	DOBBY’s action
Fly Up	Initiating Ground Takeoff
Get Down	Initiating Ground Landing
Cheers	Taking Photo(s)
DOBBY Go	Activating Palm Takeoff
DOBBY Back	Enabling Palm Landing

Emergency Shutdown

Coming soon.

Appendix 1 Specifications

Aircraft	
Weight (including battery)	199g
Size (excluding propellers)	Expanded: 135mm×145mm×36.8mm Folded up: 135mm×67mm×36.8mm
Max. operating altitude	3000m
Flight duration	9 minutes (at sea level)
Operating temperature	0~40°C
Highest wind resistance	28km/h
Positioning system	Outdoor: GPS&GLONASS dual-mode satellite positioning Indoor: optic flow (luminosity>15lux) + ultrasonic wave
Max. ascent height	GPS positioning: 50m (may be adjusted by local regulations) Optic flow and ultrasonic positioning: 3m
Max. control distance	100m (in open air free of interference)
Hovering accuracy	Vertical: ±0.1m (ultrasonic positioning active); ±0.5m (outdoor) Vertical: ±0.3m (optic flow positioning active); ±1.0m (outdoor)
Wi-Fi	
Wi-Fi frequency	2.4GHz band; 5GHz band
Camera	
Sensor	1/3.06" CMOS; Effective pixels: 13M
Lens	FOV 75°; 28mm (35mm format equivalent); f/2.2; Focus at ∞
Pitch range	-90°~22.5°
Photo size	4208×3120
Photo shooting modes	Single shot Burst shot (2-15 photos) Timed shot
White balance	Auto; Incandescent; Fluorescent; Daylight; Cloudy-daylight;
EV range	-12; -8; -4; 0; 4; 8; 12
Timed shot countdown	Off; 3s; 5s; 10s; 20s

Video recording	1080p@30fps after EIS on 4K@30fps
Video shooting modes	HD video shooting 10s auto-track short video shooting Target tracking video shooting Face tracking video shooting Orbit video shooting
Storage format	Photo: JPG Video: MP4 (MPEG-4 AVC/H.264)
Storage capacity	16GB
Data port type	Micro-USB port
Battery	
Rated capacity	970mAh
Rated energy	7.37Wh
Nominal voltage	7.6V
Battery type	LiPo 2S
Operating temperature (charge)	5~45°C
Operating temperature (discharge)	5~45°C
Max. charge voltage	8.7V
Charger	
Charging port type	Type-C
Input	DC 9V/2A
Output	DC 8.7V/1.5A
Adapter	
Input	AC 100~240V/0.5A, 50/60Hz
Output	DC 9V/2A
App	
App name	Do.Fun
Real-time image transmission	1280×720@30fps; 640×480@30fps; 320×240@30fps
Delay	160ms (depending on actual environment and mobile device)

Supported mobile device OS

Android 4.3 and later versions

iOS 8.4 and later versions

Appendix 2 Compliance Information

Federal Communications Commission (FCC) Statement

15.21

You are cautioned that changes or modifications not expressly approved by the part responsible for compliance could void the user's authority to operate the equipment.

15.105(b)

This equipment has been tested and found to comply with the limits for a Class B digital device, pursuant to part 15 of the FCC rules. These limits are designed to provide reasonable protection against harmful interference in a residential installation. This equipment generates, uses and can radiate radio frequency energy and, if not installed and used in accordance with the instructions, may cause harmful interference to radio communications. However, there is no guarantee that interference will not occur in a particular installation. If this equipment does cause harmful interference to radio or television reception, which can be determined by turning the equipment off and on, the user is encouraged to try to correct the interference by one or more of the following measures:

- Reorient or relocate the receiving antenna.
- Increase the separation between the equipment and receiver.
- Connect the equipment into an outlet on a circuit different from that to which the receiver is connected.
- Consult the dealer or an experienced radio/TV technician for help.

This device complies with Part 15 of the FCC Rules. Operation is subject to the following two conditions:

- 1) this device may not cause harmful interference and
- 2) this device must accept any interference received, including interference that may cause undesired operation of the device.

FCC RF Radiation Exposure Statement:

1. This Transmitter must not be co-located or operating in conjunction with any other antenna or transmitter.
2. This equipment complies with FCC RF radiation exposure limits set forth for an uncontrolled environment. This equipment should be installed and operated with a minimum distance of 20

centimeters between the radiator and your body.

EU Compliance Statement

ZEROTECH (Beijing) Intelligence Technology Co., Ltd. hereby declares that this device is in compliance with the essential requirements and other relevant provisions of the R&TTE Directive.

A copy of the EU Declaration of Conformity is available online at <http://www.zerotech.com/en/UserManualdown-en.html>



Industry Canada (IC) Statement

This device complies with Industry Canada licence-exempt RSS standard(s).

Operation is subject to the following two conditions:

- (1) this device may not cause interference, and
- (2) this device must accept any interference, including interference that may cause undesired operation of the device

Le présent appareil est conforme aux CNR d'Industrie Canada applicables aux appareils radio exempts de licence.

L'exploitation est autorisée aux deux conditions suivantes:

- (1) l'appareil ne doit pas produire de brouillage, et
- (2) l'utilisateur de l'appareil doit accepter tout brouillage radioélectrique subi, même si le brouillage est susceptible d'en compromettre le fonctionnement.

Caution: Exposure to Radio Frequency Radiation.

To comply with RSS 102 RF exposure compliance requirements, a separation distance of at least 20 cm must be maintained between the antenna of this device and all persons.

Pour se conformer aux exigences de conformité CNR 102 RF exposition, une distance de séparation d'au moins 20 cm doit être maintenue entre l'antenne de cet appareil et toutes les personnes.

NCC Statement

根據 NCC 低功率電波輻射性電機管理辦法 規定:

第十二條：經型式認證合格之低功率射頻電機，非經許可，公司、商號或使用者均不得擅自變更頻率、加大功率或變更原設計之特性及功能。

第十四條：低功率射頻電機之使用不得影響飛航安全及干擾合法通信；經發現有干擾現象時，應立即停用，並改善至無干擾時方得繼續使用。前項合法通信，指依電信法規定作業之無線電通信。低功率射頻電機須忍受合法通信或工業、科學及醫療用電波輻射性電機設備之干擾。

- a) 이 기기는 가정용으로 전자파적합등록을 한 기기로서 주거지역에서는 물론 모든 지역에서 사용할 수 있습니다.
- b) 당해 무선설비는 전파혼신 가능성이 있으므로 인명안전과 관련된 서비스는 할 수 없음.

La operación de este equipo está sujeta a las siguientes dos condiciones:

- (1) es posible que este equipo o dispositivo no cause interferencia perjudicial y
- (2) este equipo o dispositivo debe aceptar cualquier interferencia, incluyendo la que pueda causar su operación no deseada.